

Blue Drop Series

Book 3: Project Managers &  
Implementing Agencies

# Rainwater Harvesting and Utilisation



UN-HABITAT





# Foreword



Water is essential for the environment, food security and sustainable development. In 2000, at least 1.1 billion of the world's people – about one in five – did not have access to safe water. Asia contained 65 per cent of the population without safe water and Africa 28 per cent. Despite positive developments during the 1990s the number of urban dwellers lacking access to safe water increased by nearly 62 million. For this reason Millennium Summit set up target 10 to halve by 2015 the proportion of people without sustainable access to safe drinking water.

The increasing urbanization is a normal process of economic development and the challenge is to make this growth sustainable, efficient and equitable. Unfortunately, the positive role of urbanization is overshadowed by infrastructural deficiencies. Two million children die every year for the lack of water or for its poor quality. A billion people live in slums in overcrowded conditions without access to basic services particularly safe drinking water. The availability of water in the regions is constantly declining and health risks continue to rise. The poor pay more for water than the rich both within and between cities. Millions of girl children are forced to trade education for collecting water, or drop out from schools for the lack of even minimal sanitation facilities. Therefore, there is no better way to reduce child mortality or promote universal primary education than conserving the precious water resources for our cities especially for the poor.

Increasing access to safe water also requires addressing gender inequities. African women and girls spend three hours a day fetching water, expending more than a third of their caloric intake. Gender equality and empowering of women does require the unquestionable commitment of the policymakers to human settlements. The goals may be global but they need to be implemented locally in human settlements, where the people live and shelter and basic services like safe water are required.

Among the policy priorities for achieving target 10 of MDG 7, increasing resources and appropriate and affordable technologies for efficient water use are the important ones. Cost effective technologies are available to increase household and community access to safe water. Rainwater harvesting is one among such efficient but low-tech and cost effective technologies, which can help in meeting the challenge to provide fresh and safe water supplies. In order to harness local rainfall and local runoff to meet water needs, a variety of initiatives have been taken by some governments and communities around the world to promote water harvesting by urban households not only to encourage the use of rainwater for domestic use but also to reduce urban flooding and to increase ground water recharge.

In its pursuit to achieve the Millennium Development Goals relating to Water and Sanitation UN-HABITAT has been making an endeavour to strengthen the efforts of the cities and the communities by sharing knowledge and experiences, best practices and to help them use proven technologies for sustainable development. Hopefully a series of this UN-HABITAT publication on Rainwater Harvesting is another step in this direction, which may help undertaking rainwater harvesting programmes by communities, organizations and cities in the crisis regions of Asia, Africa, Latin America and the Caribbean.

A handwritten signature in black ink, appearing to read 'Anna Kajumulo Tibaijuka'. The signature is fluid and cursive.

**Anna Kajumulo Tibaijuka**  
Under-Secretary-General, United Nations  
Executive Director, UN-HABITAT

# Preface

Rainwater harvesting is a technology which has been practiced for more than four thousand years. The rapid population growth, combined with industrialization, urbanization, agricultural intensification and changing life styles, is resulting in a global water crisis. UN-HABITAT in pursuance of targets 10 and 11 of MDG 7 has been working to promote technologies which may help water scarce cities and towns to meet the challenge on a sustainable basis. The current series on Rainwater Harvesting and Utilization has been brought out for the awareness and sensitization of the Policy Makers, for building the capacity of beneficiaries and developing the skills of Project Managers and implementing agencies.

Rainwater Harvesting has several policy dimensions. There are several conceptual and policy issues for community based rainwater harvesting. In order to encourage rainwater harvesting by city dwellers, there is a need for an appropriate fiscal and legal framework. Book - I has been mainly prepared for Policy Makers. Besides giving an overview of the concept of rainwater harvesting it has a focus on the legal and administrative framework for rainwater harvesting. There are many countries which have taken a variety of measures to promote water harvesting by urban households. Governments have used fiscal incentives to force households for water harvesting either for reducing urban flooding or for overloading of sewerage treatment plants. Subsidies have also been provided to promote urban water harvesting by the urban poor. Several case studies given in this Book - I share this knowledge and experience of many cities to be emulated by others.

The main objective of Book - II is to directly build the capacity of the beneficiaries. It fully explains the concept and technology of rainwater harvesting and water harvesting systems. In addition, the techniques for artificial aquifer recharging relevant for different topographies are explained.

UN-HABITAT would like to promote rainwater harvesting projects not only by the individual households but also by the industries, institutions like schools and encourage the communities to maintain and sustain underground water tables through artificial recharge. Book - III specially prepared for Project Managers and implementing agencies not only dwells on harvesting rainwater for direct use but also for rainwater harvesting for artificial recharge to groundwater and planning & monitoring of artificial projects. It is hoped that this attempt of UN-HABITAT in documenting rainwater harvesting experiences in technology and its use shall facilitate an extensive use of these techniques for harvesting rainwater and meet the challenge of achieving the Millennium Development Goal for Water and Sanitation.

**Kalyan Ray**  
Senior Advisor  
Office of the Executive Director  
UN-HABITAT



# Acknowledgements

Water – being a precious item-rather a lifeline to the humanity – is getting scarce day by day. The more populous regions heading for rapid urbanization and fast depletion of water resources need utmost priority to act for conserving water and augmenting supply thereof. All this is possible through capturing rainwater. The most affected regions in the world are: Asia, Africa and Latin America & the Caribbean. Keeping in view the importance and urgent attention the subject of Rainwater Harvesting deserves, UN-HABITAT decided to undertake the task of preparing a generic guidebook on Rainwater Harvesting with a focus on rainwater harvesting and utilization in these most affected regions.

The preparation of the guidebook, called Blue Drop Series on Rainwater Harvesting and Utilization was entrusted to CITI Foundation, New Delhi, by the UN-HABITAT. Blue Drop Series was prepared under the overall supervision of Kalyan Ray, Senior Advisor, Office of the Executive Director, UN-HABITAT. Key substantive support in the form of concept and direction was provided by Andre Dzikus and design and coordination by Kulwant Singh of Water, Sanitation and Infrastructure Branch, UN-HABITAT.

An initial outline of the report was prepared by CITI Foundation in close consultation with UN-HABITAT. P.S. Mathur and Deependra Prashad did the field work and also desk-review of the available literature on the rainwater harvesting technologies as well as the best practices. Dilip Kumar Sharma together with Deependra Prashad through their commitment and professionalism did the writing and preparation of the draft guidebook. The CITI Foundation, apart from its own research, consulted, collected and collated huge information from various sources, which included available literature, contact with research institutions, experts, NGOs, discussions and other useful sources and also documented some of the case studies. The draft of the publication was circulated to experts for comments and suggestions.

The draft was extensively discussed in a workshop organized collaboratively by the Swiss NGO, the International Rainwater Harvesting Alliance (IRHA) and the Indian NGO, the Watershed Organization (WOTR) in India. IRHA also undertook the peer review of the guidebook and made useful recommendations of bringing out the guidebook in the form of Blue Drop Series in three volumes, each volume prepared for a separate target group. Based on IRHA's peer review, which analyzed the valuable information contained in the draft guidebook, the UN-HABITAT has brought out three Books on Rainwater Harvesting and Utilization under the caption "Blue Drop Series".

The report also benefited from the comments received from all the participants of the workshop organized in India. In particular those of Julie Perkins and Teshamulwa Okioga. Jogesh Kumar Arora provided valuable administrative and computer assistance.

CITI Foundation, New Delhi deserves special appreciation for completing the task of finalizing the three volumes on Rainwater Harvesting and Utilization.

## *Overall Supervision*

Kalyan Ray, UN-HABITAT



## *Concept and Direction*

Andre Dzikus, UN-HABITAT



## *Design and Coordination*

Kulwant Singh, UN-HABITAT



## *Research and Field Work*

P.S. Mathur

Deependra Prashad



## *Documentation, Writing and Editing*

P.S. Mathur

Deependra Prashad

Dilip Kumar Sharma & other team members of CITI Foundation



## *Peer Review*

Margarita Pacheco-Montes, IRHA

Julie Perkins, UN-HABITAT

Teshamulwa Okioga, RELMA at ICRAF



## *Computer Technical Assistance*

Jogesh Kumar Arora



# Contents

---

<b>1</b>	<b>Introduction</b>	<b>1</b>
	Global Demographic Trends	1
	The World Water Crisis	2
	Scenario in Selected Cities	3
	Benefits of Rainwater Harvesting	3
	The Growing Global Interest in Rainwater Harvesting	4
	Objectives of the UN-HABITAT Guide on Rainwater Harvesting	6
	Water for Cities Programme	7
	Programme Objectives	7
	Key Programme Activities	8
	Partnership and Capacity Building for Pro-poor Investments	8
	Users of the “Blue Drop Series”	8
<b>2</b>	<b>Concept and Technology of Rainwater Harvesting</b>	<b>9</b>
	Water Harvesting	9
	Historical Development of Rainwater Harvesting and Utilisation	10
	Ideal Conditions for Rainwater Harvesting and Artificial Recharge to Ground Water	10
	Types of Rainwater Harvesting Systems	11
	Influencing Factors	12
	Harvesting System	14
	The Contribution of Water to a Sustainable Water Strategy	15
<b>3</b>	<b>Harvesting Rainwater for Direct Use</b>	<b>18</b>
	Scale of Operations	18
	Components of a Rainwater Harvesting System	19
	Filters Developed in Other Countries	36
	Tasks Needing Frequent Attention of Householders	40
	Annual or Infrequent Tasks for Which Technical Assistance May be Required	40
<b>4</b>	<b>Rainwater Harvesting Around the World – Case Studies &amp; Success Stories</b>	<b>41</b>
	South Asia	42
	South-East Asia	49

Central Asia	52
Europe	54
America: North, South & Central	55
<b>5 Rainwater Harvesting for Artificial Recharge to Ground Water</b>	<b>65</b>
Rainwater Harvesting for Artificial Recharge to Ground Water	65
Techniques for Artificial Recharge in Urban Settlements	66
<b>6 Planning and Monitoring of Artificial Recharge Projects</b>	<b>76</b>
Basic Requirement for Artificial Recharge Projects	76
Planning of Artificial Recharge Projects	77
Impact Assessment	78
Evaluation Criteria	79
<b>References</b>	<b>81</b>
<b>Glossary</b>	<b>87</b>
<b>Rainwater Harvesting FAQs</b>	<b>90</b>
<hr/>	
<b>List of Boxes</b>	
Box 1.1 Rainwater Harvesting - Multiple Benefits	3
Box 2.1 Ancient and Traditional Integrated Rainwater Management System in Mexico	11
Box 2.2 Potential of Water Availability through Rooftop RWH in Delhi (North India)	15
Box 4.1 Designing Rainwater Harvesting Systems in Urban Environment for Direct Use	43
<hr/>	
<b>List of Tables</b>	
Table 2.1 Runoff Coefficients for Various Catchment Surfaces	13
Table 3.1 Sizing of Rainwater Pipes for Roof Drainage	21
Table 3.2 Relative Merits of Some Common Tank Shapes	25
Table 3.3 Tank Capacities	27
Table 3.4 Materials for Rain Water Tanks	28
Table 3.5 Big vs. Small Tank: Cost Comparison	30
Table 3.6 Comparative Cost for Rainwater Tanks	31
Table 3.7 Treatment Techniques	35
<hr/>	
<b>List of Charts</b>	
Chart 3.1 Water flows within the Urban Ecosystem	18

---



---





## Introduction

Water forms the lifeline of any society. Water is essential for the environment, food security and sustainable development. All the known civilizations have flourished with water source as the base and it is true in the present context too. Availability of drinking water and provision of sanitation facilities are the basic minimum requirements for healthy living. Water supply and sanitation, being the two most important urban services, have wide ranging impact on human health, quality of life, environment and productivity. Despite the technological advancements, the global scenario still remains grim, as all the inhabitants of the world do not have access to safe water and adequate sanitation.

In most urban areas, the population is increasing rapidly and the issue of supplying adequate water to meet societal needs and to ensure equity in access to water is one of the most urgent and significant challenges faced by the policy-makers.

With respect to the physical alternatives to fulfil sustainable management of freshwater, there are two solutions: finding alternate or additional water resources using conventional centralised approaches; or utilising the limited amount of water resources available in a more efficient way. To date, much attention has been given to the first option and only limited attention has been given to optimising water management systems. Among the various technologies to augment freshwater resources, rainwater harvesting and utilisation is a decentralised, environmentally sound solution, which can avoid many environmental problems often caused by conventional large-scale projects using centralised approaches.

Rainwater harvesting, in its broadest sense, is a technology used for collecting and storing rainwater for human use from rooftops, land surfaces or rock catchments using simple techniques such as jars and pots as well as engineered techniques. Rainwater harvesting has been practiced for more than 4,000 years, owing to the temporal and spatial variability of rainfall. It is an important water source in many areas with significant rainfall but lacking any kind of conventional, centralised supply system. It is also a good option in areas where good quality fresh surface water or ground water is lacking. The application of appropriate rainwater harvesting technology is important for the utilisation of rainwater as a water resource.

### Global Demographic Trends

The World population has more than doubled since 1950 and reached 6.15 billion in 2001. The most recent population forecasts from the United Nations indicate that, under a medium-fertility scenario, global population is likely to peak at about 8.9 billion in 2050.

In parallel with these demographic changes, there have been profound demographic shifts as people continue to migrate from rural to urban areas in search of work and new opportunities. The number of people living in urban areas has jumped from 750 million in 1950 to nearly 2.93 billion in 2001. Currently, some 61 million people are added to cities each year through rural to urban migration, natural increase within cities, and the transformation of villages into urban areas. By 2025, the total urban population is projected to increase to more than five billion, and 90 per cent of this increase is expected to occur in developing countries. Sixty per cent of the global population is living in Asia. Urban population growth in Asia at 2.7 per cent per annum is 27 per cent higher than the global average. Asia's population living in urban areas is projected at 43.0 per cent for 2010 and will represent 50.8 per cent of world's total urban population. Asia is expected to double its urban population by the year 2020. By 2025, the majority of this region's population will live in cities. By 2015, there will be 153 cities of one million inhabitants, 22 cities with 8 or more million people and 15 with 10 to 20 million people.

The population of urban Africa is estimated to increase from 37.2 per cent in 2000 to 42.7 percent in 2010 and will represent 12.1 per cent of the world's urban population. The share of Latin America & the Caribbean is projected to increase from 75.4 per cent in 2000 to 79.0 percent in 2010, representing 13.4 per cent of the world's urban population.

The urban population of Africa, Asia and Latin America and the Caribbean is now nearly three times the size of urban population of the rest of the world. This population is growing so much faster than the rural population that 85 per cent of the growth in the world's population between 2000 and 2010 will be in urban areas and virtually all this growth will be in Africa, Asia and Latin America. Given that many natural resources (such as water, soil, forests and fish stocks) are already being exploited beyond their limits in some regions, significant effort will be required to meet the needs of additional people in the next 50 years.

### The World Water Crisis

Rapid population growth, combined with industrialisation, urbanisation, agricultural intensification and water-intensive lifestyles is resulting in a global water crisis. In 2000, at least 1.1 billion of the world's people - about one in five - did not have access to safe water. Asia contains 65 per cent of the population without safe water and Africa 28 per cent. During the 1990s, there were some positive developments: about 438 million people in developing countries gained access to safe water but due to rapid population growth, the number of urban dwellers lacking access to safe water increased by nearly 62 million.

Falling water tables are widespread and cause serious problems, both because they lead to water shortages and, in coastal areas, to salt intrusion. Both contamination of drinking water and nitrate and heavy metal pollution of rivers, lakes and reservoirs are common problems throughout the world. The

world supply of freshwater cannot be increased. More and more people are becoming dependent on limited supplies of freshwater that is becoming more polluted. Water security, like food security, is becoming a major national and regional priority in many areas of the world.

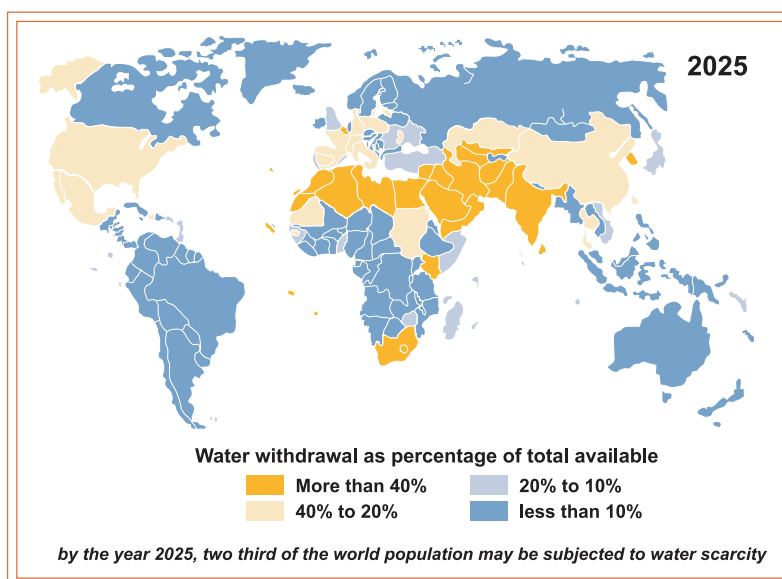

## Scenario in Selected Cities

In **Kolkata, India**, about half the population that lives in the slum or squatter settlements collect water from stand posts. The rest of the slum population do not have access to the municipal water supply and have to make their own arrangements – for instance relying on handpumps/drawing from tube wells. In **Bangalore, India** a city of some 6 million inhabitants, it is estimated that more than half depends on public fountains. Almost a third of the population has partial or no access to piped water. In **Dhaka, Bangladesh** it is estimated that in 2002 there were 2.5 million people in its ‘slum’ areas with most having very inadequate provision for water and sanitation. Tens of thousands of children die each year in Dhaka because of waterborne diseases and polluted water. In **Pakistan** more than half of **Karachi’s** 12 million inhabitants live in *katchi abadis*. Only half the *katchi abadis* have piped water. In **Faisalabad, Pakistan** some two thirds of the city’s two million inhabitants live in largely unserviced areas. Over half have no piped water supply.

In **Kampala (Uganda)** only inhabitants of affluent and middle-income districts in central and residential areas have private connections serviced by National Water & Sewerage Corporation. More than half the population in **Nairobi (Kenya)** depend on standpipe vendors for access to water; 30% of the population have a connection to the official network. In **Lima (Peru)** almost 2 million inhabitants have no water supply and 30% of those who do receive water (1996) is of dubious quality. The water shortage in **Tugucigalpa (Honduras)** is particularly acute as there is not even enough water to supply to consumers already having municipal water connections.

To further illustrate, **India’s** population as per 2001 census is 1027.02 million. Over 60 per cent of households in India meet their drinking water requirements from underground water sources such as hand pumps, tube wells and wells. In urban areas while 68.7 per cent households use tap water, 29 per cent of the households directly use those underground water resources. Intense use of underground water has resulted in depletion of sub-terrene water resources in many parts of India.

## Benefits of Rainwater Harvesting

Rainwater harvesting provides the long-term answers to the problem of water scarcity. Rainwater harvesting offers an ideal solution in areas where there is sufficient rain but inadequate ground water supply and surface water resources are either lacking or are insufficient. In hilly areas, rainwater can be used by humans, vegetation and animals. Rainwater harvesting system is particularly useful in remote and difficult terrain as it has the ability to operate independently. The whole process is environment friendly. There are a number of ways in which water harvesting can benefit a community – water harvesting enables efficient collection and storage of rainwater, makes it accessible and substitutes for poor quality water (Box 1.1). Water harvesting helps smooth out variation in water availability by collecting the rain and storing it more efficiently in closed stores or in sandy riverbeds. In doing so, water harvesting assures a continuous and reliable access to water.

A water harvesting system collects and stores water within accessible distance of its place of use. While traditional sources are located away from the community particularly in peri-urban areas, collecting and storing water close to households, villages or pastures greatly enhances the accessibility and convenience of water supplies.

### Box 1.1 Rainwater Harvesting - Multiple benefits

- ❖ Improvement in the quality of ground water
- ❖ Rise in the water levels in wells and bore wells that are drying up
- ❖ Mitigation of the effects of drought and attainment of drought proofing
- ❖ An ideal solution to water problems in areas having inadequate water resources
- ❖ Reduction in the soil erosion as the surface runoff is reduced
- ❖ Decrease in the choking of storm water drains and flooding of roads
- ❖ Saving of energy, to lift ground water. (One-meter rise in water level saves 0.40-kilowatt hour of electricity)



The rainwater collected can be stored for direct use or can be recharged into the ground water to improve the quality of ground water and rise in the water levels in wells and bore wells that are drying up as well as reduce the soil erosion as the surface runoff is reduced. Rainwater harvesting is an ideal solution to water problems in areas having inadequate water resources and helpful in mitigation of the effects of drought and attainment of drought proofing.

Water harvesting provides an alternative source for good quality water (rainwater is the cheapest form of raw water) seasonally or even the year round. This is relevant for areas where ground water or surface water is contaminated by harmful chemicals or pathogenic bacteria or pesticides and/or in areas with saline surface water. The rainwater harvesting systems can be both individual and community/utility operated and managed. Rainwater collected using various methods has less negative environmental impacts compared to other technologies for water resources development. The physical and chemical properties of rainwater are usually superior to sources of ground water that may have been subjected to contamination. Rainwater is relatively clean and the quality is usually acceptable for many purposes with little or even no treatment.

Rainwater harvesting technologies are flexible and can be built to meet almost any requirements. Construction, operation, and maintenance are not labour intensive. Predictions regarding global warming could have a major effect in significantly increasing water demand in many cities. At the same time increased evaporation from reservoirs and reduced river flows in some areas may decrease the available surface water supplies. A greater uncertainty regarding yields from major reservoirs and well fields is likely to make investments in the diversification of water sources, better water management and water conservation even more prudent in future. The role of rainwater harvesting systems as sources of supplementary, back-up, or emergency water supply will become more important especially in view of increased climate variability and the possibility of greater frequencies of droughts and floods in many areas. This will particularly be the case in areas where increasing pressure is put on existing water resources.

In urban areas, scarcity and accelerating demand of water is a major problem and it can be reduced by rainwater harvesting, using various existing structures like rooftops, parking lots, playgrounds, parks, ponds, flood plains, etc. to increase the ground water table, which saves the electric energy to lift the ground water because one-metre rise in water level saves 0.40 kilowatt hour of electricity. Subsequently it can also reduce storm drainage load and flooding in city streets.

As cities continue to grow in the future such problems are likely to become increasingly common. Since cities comprise numerous impervious surfaces designed to encourage rainwater runoff the scope for rainwater collection is substantial. Atmospheric pollution remains a major constraint as it contaminates both the rainwater and catchment surfaces making rainwater unsuitable for drinking in many cities around the world. Nevertheless, rainwater can still be used for non-potable uses such as toilet flushing, clothes washing and gardening. Furthermore, greater use of rainwater in urban areas could in future significantly strengthen the lobby to clean up the urban atmosphere entirely.

### The Growing Global Interest in Rainwater Harvesting

With development of modern 'conventional' water supply systems in the first half of this century, many traditional water sources went out of favour. This was the case with rainwater harvesting technologies which came to be considered only as an option of last resort. While the exploitation of rainwater was considered appropriate in certain extreme situations such as on coral islands or at remote farms for which reticulated supplies were uneconomic, little serious consideration was given to the more general use of the technology.

Since around 1980, however, things have changed and there have been numerous grassroots initiatives supported by enlightened government and donor agencies promoting and implementing rainwater harvesting technologies. This has partly been a response to the growing technical feasibility of using roof catchment systems in the South due to the spread of impervious roofing materials in urban as well as rural areas. It has also been motivated by a paradigm shift regarding global attitudes to the environment and the growing realisation that water resource utilisation has to become more sustainable. In 1979 UNEP commissioned a series of regional case studies into *Rain and Storm water Harvesting in Rural Areas*. This included work from China, India, Mexico, the U.S., Africa, Australia, and the South Pacific. This was the first time a global overview of experiences with the technology was brought together in a single publication. Another even more influential overview by Pacey, A. & Cullis, A. 1986 followed soon after. At around the same time, UNICEF, several bi-lateral donor agencies (including DANIDA and SIDA), and many NGOs were promoting the use of household roof catchment tanks in East Africa and working on developing various low cost designs in Kenya. This work, much of which was done directly with community groups, led to rapid rates of adoption of roof tanks among rural communities. In a parallel development, the first conference on the use of rainwater cisterns for domestic water supply was held in Honolulu, Hawaii in 1982 attracting around 50 mainly academic participants. It was not envisaged at the time that the meeting would herald the beginning of a series of international conferences on the topic over the next 20 years which would include thousands of participants from a very broad cross-section of countries and professions.

The next three conferences took place in the U.S. Virgin Islands (1984), Thailand (1987), and the Philippines (1989) at which point the scope of the conference series was broadened to include other forms of rainwater catchment systems such as rainwater harvesting for agriculture. At the 1989 conference in Manila, it was also agreed to set up an Association to oversee the conference series and endeavour to promote the technology worldwide. Subsequent conferences took place in Taiwan (1991), Kenya (1993), China (1995), Iran (1997), Brazil (1999) and Germany (2001).

In addition to international conferences, many regional, national, and local meetings and initiatives took place during this period reinforcing the suggestion that the technology is now being given more attention globally than at any time prior to 1980. These have included the efforts by the New Delhi based Centre for

Science and Environment to revive traditional rainwater harvesting practices in India (Agarwal & Narain 1997); the establishment of a rainwater harvesting forum in Sri Lanka (LRWHF 1999); setting up of People for Promoting Rainwater Utilisation (PPRU) in April 1995 in Tokyo, Japan and new initiatives such as the promotion on

#### International Conferences on Rainwater Harvesting

- Hawaii (1982)
- U.S. Virgin Islands (1984)
- Thailand (1987)
- The Philippines (1989)
- Taiwan (1991)
- Kenya (1993)
- China (1995)
- Iran (1997)
- Brazil (1999)
- Germany (2001)

**The Millennium Development Goal (7)** of ensuring environmental sustainability has set out the target of reducing the proportion of people without sustainable access to safe drinking water to half by 2015.

It is generally believed that water and sanitation provision has been a serious constraint in urban areas in nations that have experienced the most rapid increase in their urban population as a proportion of their total population (i.e. urbanization levels) but this is not uniformly true. In fact some of the regions with the largest increase in urbanization levels have achieved much better levels of water and sanitation provision than some regions with smaller increases. Many of the world's most rapidly growing cities over the last 50 years have very good water and sanitation provision and many slower growing cities or smaller urban centres have very poor provision. It is surprising that such large cities do not face serious water shortages. In the case of Asia, however, the picture, by and large, is quite disappointing.

rainwater utilisation in modern mega cities such as Tokyo (Murase 1994). The Vision 21 initiative also placed the use of appropriate technologies such as rainwater harvesting at the centre of its proposed strategies for providing clean water, adequate sanitation, and hygiene education for 95% of the population by 2025.

Rainwater harvesting/collection is considered among the most appropriate technologies for efficient use. In pursuance of the Millennium Development Goals, UN-HABITAT, therefore, has decided to bring out a guidebook on rainwater harvesting under Water for Asian Cities Programme in “Blue Drop Series” to encourage rainwater harvesting as part of the strategy for integrated water resource management in the Asian Region, Africa and Latin America & the Caribbean.

### Objectives of the UN-HABITAT Guide on Rainwater Harvesting

In the hydrological cycle, rain is the first form of water that we know and hence is a primary source of water for us. Rivers, lakes and ground water are all secondary sources of water. In the present times, we depend entirely on such secondary sources of water and the primary source has been neglected to a great extent.

The purpose of the “Blue Drop Series” is to introduce the planners, decision makers, project managers, beneficiaries



and others to the concept and technology of rainwater harvesting in urban areas and to show them where it fits into the overall picture of appropriate and sustainable community water supply development in urban areas. Just like other water resources, rainwater harvesting is an option to be considered when planning an improved water supply system with a community. Depending on local environmental conditions, water harvesting may provide a supplementary supply, an alternative supply or the only feasible improved supply, especially in urban areas which are heavily dependent on underground water. The information provided on

technical issues is quite specific, as considerable experience is available, in particular in the area of construction technologies involved in rainwater harvesting.

The information on socio-economic aspects though less specific has also been provided as no tailor-made approaches can be recommended and much will have to be developed to cope with the differences in size, social organization, leadership and complicity of the urban community concerned. This “Blue Drop Series” has been prepared with the objective of presenting the basics required for undertaking rainwater harvesting. The three books under the series have been written in a simple form so that these can be used even by ordinary householders.

Apart from various methods and techniques for water harvesting, selected case studies of harvesting systems designed by various organizations working in the field of rainwater harvesting have been cited so that establishments with similar conditions can take up water harvesting on the same lines. This volume specifically presents methods suitable for singular building/establishment level – residences, institutions and industries. The scope of water harvesting can be extended to a locality/community level by incorporating various such singular units into a group. As one may learn through the “Blue Drop Series”, broadly there are two approaches to harvesting water – storing of water for direct use or recharging of ground water.

The “Blue Drop Series” on water harvesting is comprehensive enough and incorporates useful information on various innovations in techniques that can be applied. This guide on water harvesting has been conceived as part of the broader objectives of the Water for Asian Cities Programme.



## Water for Cities Programme

The objectives of the Water for African Cities programme and the Water for Asian Cities programme are to reduce the urban water crisis in cities through efficient and effective water demand management, to build capacity to reduce the environmental impact of urbanisation on fresh water resources and to boost awareness and information exchange on water management and conservation.

### Water for African Cities Programme

A programme on Water for African cities was launched by UN-HABITAT in 1999 as a direct response to the Cape Town Resolution (1997) adopted by African Ministers addressing the urban water challenge facing the continent. This was the first comprehensive initiative to support African Countries to effectively manage the growing urban water crisis and protect the continent's threatened water resources from the increasing volume of land based pollution from the cities. The main objectives under the programme include:

- ❖ Development of water-related environmental education strategy for African cities.
- ❖ Establishment of water classrooms
- ❖ Schools water audit
- ❖ Water quality education
- ❖ Curriculum development and introducing water education in pilot schools
- ❖ Non-formal education with community initiatives
- ❖ Water health care education
- ❖ Information exchange and North-South twinning arrangements.

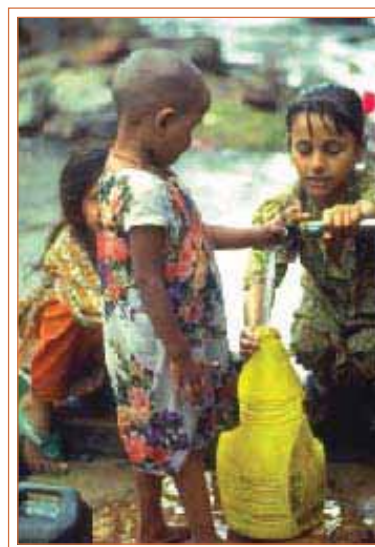

### Water for Asian Cities Programme

To meet the Millennium Declaration Goal of halving the proportion of people without access to improved services by 2015, an additional 1.5 billion people in Asia will need access to adequate sanitation facilities, while an additional 980 million will need access to safe water. In urban areas, the corresponding figures are 675 million and 619 million respectively. Emphasis on urban water and sanitation has also been placed in the Millennium Declaration by setting a target of improving the living conditions of at least 100 million slum dwellers by 2020.

Following the New Delhi Consultation in April 2002, UN-HABITAT together with ADB launched this regional programme on Water for Asian Cities to promote pro-poor investments in water and sanitation in the region. The New Delhi Consultation made specific recommendations with regard to the implementation strategy and partnership arrangements for the proposed programme.

## Programme Objectives

The Programme focuses on three inter-linked priorities.

- (i) Introducing demand-responsive and demand management strategies to improve efficiency of water-use and give more influence to those currently deprived of water and sanitation
- (ii) Scaling-up sanitation provision city-wide through innovative public-private-NGO partnerships, finance mechanisms and appropriate technical choices

- (iii) New pro-poor investments in urban water supply and sanitation with emphasis on serving the urban poor with piped water and formal sanitation facilities

### Key Programme Activities

- ❖ Monitoring of progress towards achieving Millennium Goal targets in the water and sanitation sector in Asian cities.
- ❖ Mobilization of political will through advocacy and exchange of information.
- ❖ Strengthening regional, country and city level capacities for integrated water and sanitation management. This requires human resource development in a focused manner, strengthening the capacity of existing institutions. Gender mainstreaming is an important crosscutting theme of capacity building at all levels.
- ❖ Creating a new ethic among children and community through Water, Sanitation and Hygiene Education. Interventions include: introducing value-based water education in schools; establishing water education classrooms in pilot cities; community education, training of trainers etc. Twinning of cities and schools is part of this initiative.
- ❖ Promoting pro-poor investments in the water and sanitation sector. This calls for the establishment of a pro-poor governance framework at the city level through stakeholder consultations, to facilitate the necessary policy and institutional reforms required for improving water and sanitation services for the urban poor. Investments in water supply and sanitation in Asian cities will provide the source developments, pipelines, treatment plants, reservoirs and distribution systems to bring water to those without direct access to piped water. It will also provide sanitation facilities in those cities, based on appropriate technology.

### Partnership and Capacity Building for Pro-poor Investments

The programme commenced with a partnership development phase. The focus in this phase was on developing a framework for collaboration among city level actors as also with external support agencies and other ongoing programmes.

The central emphasis of the Water for Asian Cities Programme is on capacity building in the countries and cities in the region with a view to prepare the environment for pro-poor investments in the water and sanitation sector. While the Capacity Building Phase of the Programme is being directed to enhancing the willingness and commitment of the policy makers and creating the necessary institutional and human resource capacity to implement pro-poor policies and programmes, the investment promotion phase of the Programme shall be directed to creating the enabling environment for pro-poor investments.

### Users of the “Blue Drop Series”

The “Blue Drop Series” on Rainwater Harvesting and Utilisation consists of three books and has been designed for policy makers, planners and all those involved in the implementation of urban water supply programmes. It has been prepared with a view to integrate the “state of the art” on Rainwater Harvesting to provide handy, self-contained reference volumes for use by all levels of functionaries in this sector in different regions of the world.

This volume, “Blue Drop Series” Book 3, has been designed for Project Managers and Implementation Agencies. The Book consists of six chapters including the introduction about Rainwater Harvesting requirements, benefits and the role of UN-HABITAT in Rainwater Harvesting. The information contained in the Book provides valuable exposure to information/data on various issues on rainwater harvesting like concept & technology, rainwater harvesting systems, ground water recharge, success stories and also monitoring & evaluation of rainwater harvesting.

# Concept and Technology of Rainwater Harvesting

## Water Harvesting

Scientifically, water harvesting refers to collection and storage of rainwater and other activities aimed at harvesting surface and ground water. It also includes prevention of losses through evaporation and seepage and all other hydrological and engineering interventions, aimed at conservation and efficient utilisation of the limited water endowment of physiographic units such as a watershed. In general, water harvesting is the activity of direct collection of rainwater. The rainwater collected can be stored for direct use or can be recharged into the ground water. Rain is the first form of water that we know in the hydrological cycle, hence is a primary source of water for us (see figure 2.1).

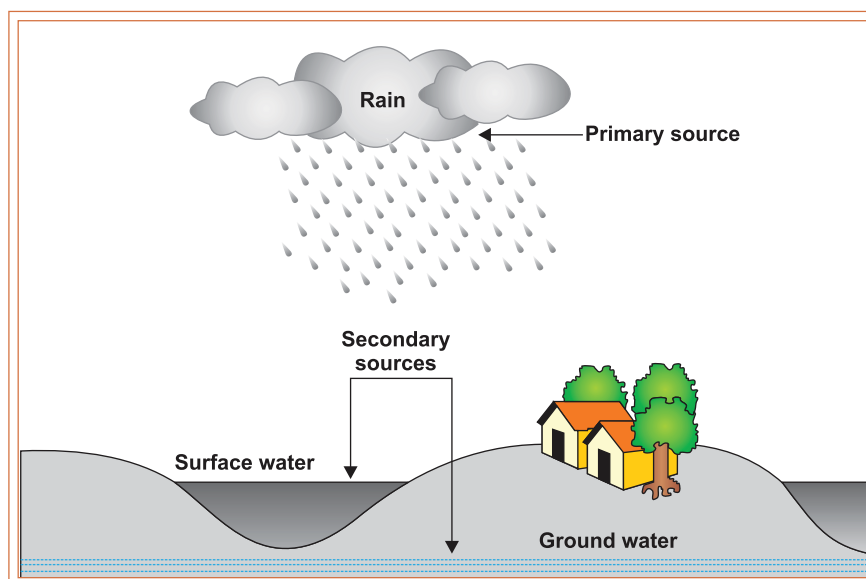

Figure 2.1: Where does all our water come from?

Rivers, lakes and ground water are all secondary sources of water. In present times, we depend entirely on such secondary sources of water. **In the process, generally, it is forgotten that rain is the ultimate source that feeds all these secondary sources.** Water harvesting means making optimum use of rainwater at the place where it falls so as to attain self-sufficiency in water supply, without being dependent on remote water sources.



### Historical Development of Rainwater Harvesting and Utilisation

Rainwater harvesting and utilisation systems have been used since ancient times and evidence of roof catchment systems date back to early Roman times. Roman villas and even whole cities were designed to take advantage of rainwater as the principal water source for drinking and domestic purposes since at least 2000 B.C. In the Negev desert in Israel, tanks for storing runoff from hillsides for both domestic and agricultural purposes have allowed habitation and cultivation in areas with as little as 100mm of rain per year.

The earliest known evidence of the use of the technology in Africa comes from northern Egypt, where tanks ranging from 200 to 2000 m<sup>3</sup> have been used for at least 2000

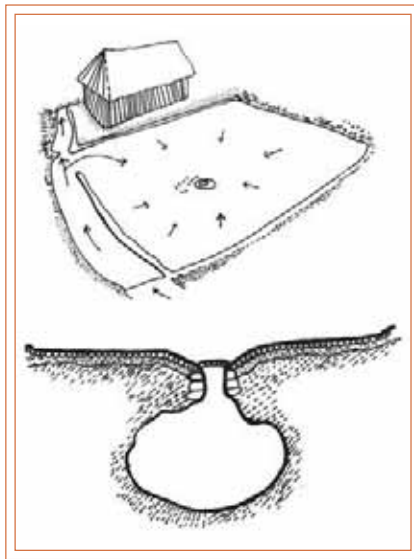
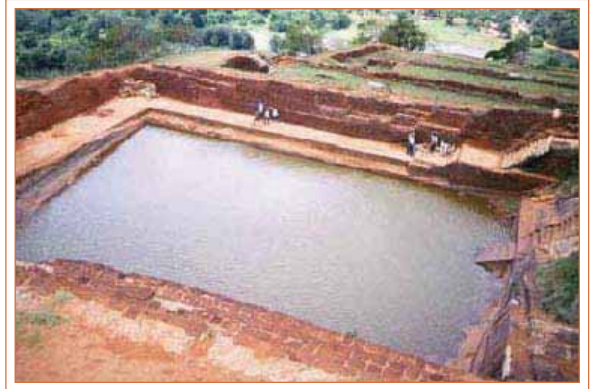

years – many are

still operational today. The technology also has a long history in Asia, where rainwater collection practices have been traced back almost 2000 years in Thailand. The small-scale collection of rainwater from the eaves of roofs or via simple gutters into traditional jars and pots has been practiced in Africa and Asia for thousands of years.

In many remote rural areas, this is still the method used today. The world's largest rainwater tank is probably the Yerebatan Sarayi in Istanbul, Turkey. This was constructed during the rule of Caesar Justinian (A.D. 527-565). It measures 140m by 70m and has a capacity of 80,000 cubic metres. Rainwater harvesting is practiced on a large scale in many Indian cities like Chennai, Bangalore and Delhi where rainwater harvesting is a part of the state policy. Elsewhere, countries like Germany, Japan, United States, and Singapore are also adopting rainwater harvesting.

*Ref: Technical Notes, Intermediate Technology Development Group, UK*

### Ideal Conditions for Rainwater Harvesting and Artificial Recharge to Ground Water

Artificial recharge techniques are adopted where:

- ❖ Adequate space for surface storage is not available especially in urban areas.
- ❖ Water level is deep enough (> 8 m.) and adequate sub-surface storage is available.
- ❖ Permeable strata are available at shallow/moderate depth.
- ❖ Adequate quantity of surface water is available for recharge to ground water.
- ❖ Ground water quality is bad and the aim is to improve it.
- ❖ There is possibility of intrusion of saline water especially in coastal areas.
- ❖ The evaporation rate is very high from surface water bodies.

In other areas, rainwater-harvesting techniques may be adopted.

**Box 2.1**
**Ancient and Traditional Integrated Rainwater Management System in Mexico**

This refers to the Pre-Columbian practices of the Maya people in the Yucatan, Mexico. Mexico as a whole is rich in ancient and traditional rainwater harvesting technologies (dating back to the Aztecs and Mayas).

South of the city Oxkutzcab on the foot of the Puuc Mountain we can still see the achievements of the Mayas. In the 10th century AD an integrated agriculture based on rainwater harvesting existed in this region. The people lived on the hillsides and their drinking water was provided by 20 to 45 thousand litres cisterns called “Chultuns”. These cisterns had a diameter of about 5 m and were excavated in the lime subsoil with a waterproof plaster. Above them there was a ground catchment area of 100 to 200 m<sup>2</sup>.

Fig: Cistern of the Maya people, called Chultun, capacity: 45,000 l, diameter: 5m, catchment area: 150 m<sup>2</sup>, the manhole is covered by a stone with a hole in the middle, where a wooden bolt is put, which recedes when it rains (Neugebauer).

In the valleys below, other types of rainwater catchment systems were used such as Aguadas (artificially dug rainwater reservoirs from 10 to 150 million litres) and Aguaditas (small artificial reservoirs from 100 to 50,000 litres).

It is interesting to see that the aguadas and aguaditas were used to irrigate fruit trees and/or forests and to provide water for the plantation of vegetables and corn on small areas. Lots of water was stored, guaranteeing water supply even during unexpected droughts. This is one example of integrated water management and we can find many similar ones all over the world.



## Types of Rainwater Harvesting Systems

Typically, a rainwater harvesting system consists of three basic elements: the collection system, the conveyance system, and the storage system. Collection systems can vary from simple types within a household to bigger systems where a large catchment area contributes to an impounding reservoir from which water is either gravitated or pumped to water treatment plants. The categorisation of rainwater harvesting systems depends on factors like the size and nature of the catchment areas and whether the systems are in urban or rural settings.

## Influencing Factors

Among the several factors that influence the rainwater harvesting potential of a site, eco-climatic conditions and the catchment characteristics are considered to be the most important.

### Rainfall

- ❖ **Quantity:** Rainfall is the most unpredictable variable in the calculation and hence, to determine the potential rainwater supply for a given catchment, reliable rainfall data are required, preferably for a period of at least 10 years. Also, it would be far better to use rainfall data from the nearest station with comparable conditions.
- ❖ **Pattern:** The number of annual rainy days also influences the need and design for rainwater harvesting. The fewer the annual rainy days or the longer the dry period, the more the need for rainwater collection in a region. However, if the dry period was too long, big storage tanks would be needed to store rainwater. Hence in such regions, it is more feasible to use rainwater to recharge ground water aquifers rather than for storage.

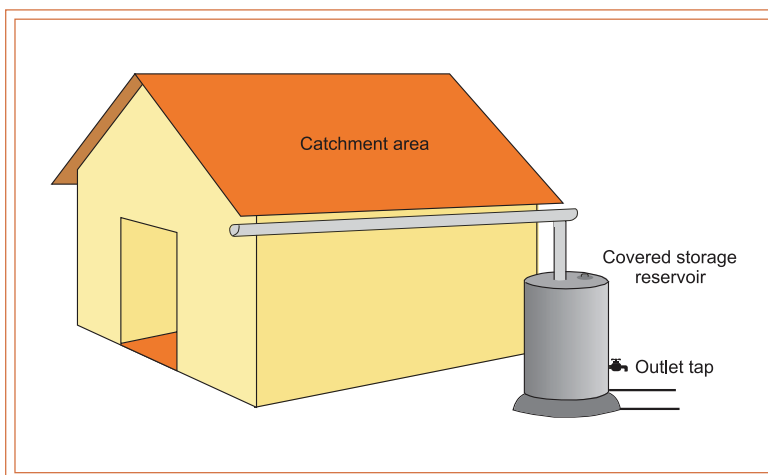

### Catchment Area Characteristics

Runoff depends upon the area and type of the catchment over which it falls, as well as surface features. All calculations relating to the performance of rainwater catchment systems involve the use of runoff coefficient to account for losses due to spillage, leakage, infiltration, catchment surface wetting and evaporation, which will all contribute to reducing the amount of runoff. (Runoff coefficient for any catchment is the ratio of the volume of water that runs off a surface to the volume of rainfall that falls on the surface).

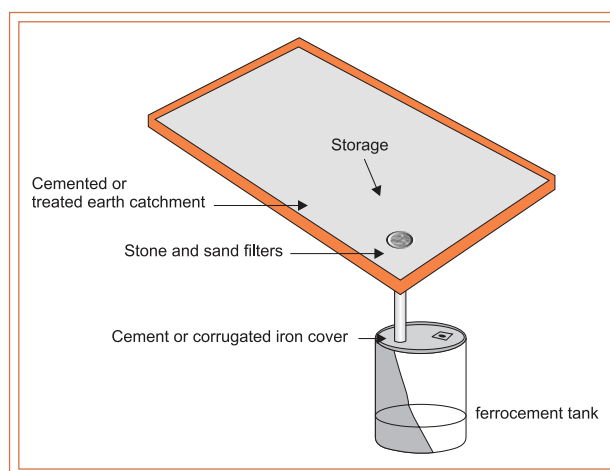

$$\text{Water harvesting potential} = \text{Rainfall (mm)} \times \text{Area of catchment} \times \text{Runoff coefficient}$$

or

$$\text{Water harvesting potential} = \text{Rainfall (mm)} \times \text{Collection efficiency}$$

The *collection efficiency* accounts for the fact that all the rainwater falling over an area cannot be effectively harvested, because of evaporation, spillage etc. Factors like runoff coefficient (*see Table 2.1: Runoff coefficients for various catchment surfaces*) and the first-flush wastage (*refer section on Roof Washers/First-Flush device in Chapter 3*) are taken into account when estimating the collection efficiency.

**Table 2.1: Runoff Coefficients For Various Catchment Surfaces**

Type of Catchment	Coefficient
<b>Roof Catchments</b>	
❖ Tiles	0.8 - 0.9
❖ Corrugated metal sheets	0.7 - 0.9
<b>Ground Surface Coverings</b>	
❖ Concrete	0.6 - 0.8
❖ Brick pavement	0.5 - 0.6
<b>Untreated Ground Catchments</b>	
❖ Soil on slopes less than 10 per cent	0.0 - 0.3
❖ Rocky natural catchments	0.2 - 0.5
❖ Green Area	0.05 - 0.10

Source: Pacey, Arnold and Cullis, Adrian 1989, Rainwater Harvesting: The collection of rainfall and runoff in rural areas, Intermediate Technology Publications, London

The following illustration highlights the enormous potential for rainwater harvesting. The same procedure can be applied to get the potential for any plot of land or rooftop area, using rainfall data for that area. Consider a building with a flat terrace area of 100 sq. m. The average annual rainfall in the city is approximately 600 mm (24 inches). In simple terms, this means that if the terrace floor is assumed to be impermeable, and all the rain that falls on it is retained without evaporation, then, in one year, there will be rainwater on the terrace floor to a height of 600 mm.

Area of plot = 100 sq.m. = 120 sq.yd

Height of rainfall = 0.6 m = 600 mm or 24 inches

Volume of rainfall = Area of plot x Height of rainfall over the plot  
 = 100 sq.m. x 0.6 m  
 = 60 cu.m. = 60,000 litres

Assuming that only 60% of the total rainfall is effectively harvested,

Volume of water harvested = 60,000 litres x 0.6 = 36,000 litres

This volume is about twice the annual drinking water requirement of a 5-member family. The average daily drinking water requirement per person is 10 litres.

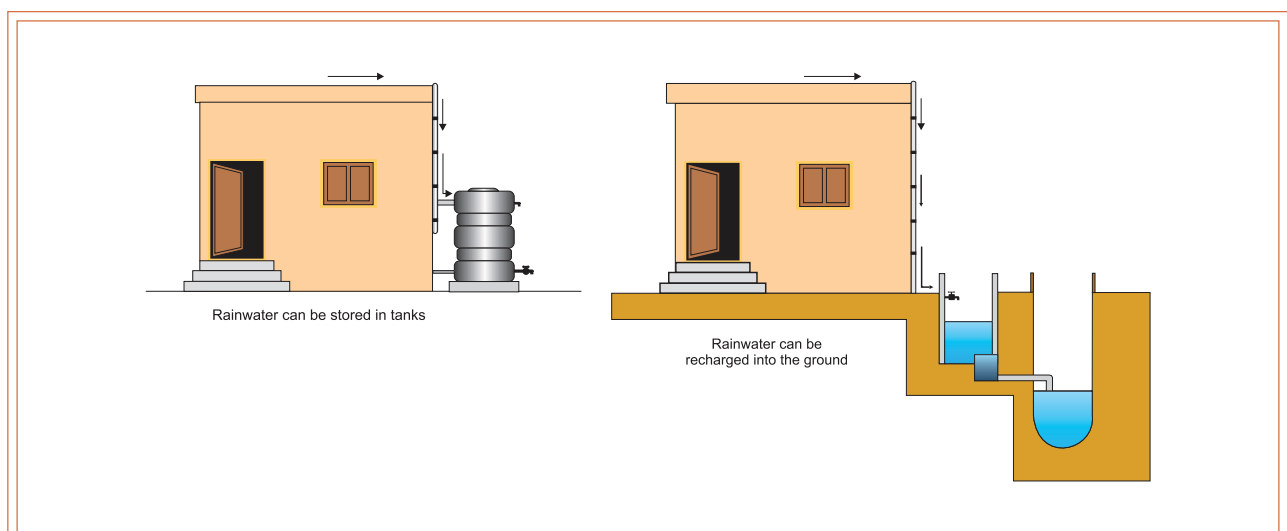



## Harvesting System

Broadly, rainwater can be harvested for two purposes

- ❖ Storing rainwater for ready use in containers above or below ground
- ❖ Charged into the soil for withdrawal later (ground water recharging)

### Storing Rainwater or Recharging Ground Water

Rainwater can be stored for direct use or alternatively it can be charged into the ground water aquifers. This can be done through any suitable structures like dug wells, bore wells, recharge trenches and recharge pits. The decision whether to store or recharge water depends on the rainfall pattern of a particular region. For example, in places like Kerala and Mizoram in India, rain falls throughout the year, barring a few dry periods. In such places, one can depend on a small domestic-sized water tank for storing rainwater, since the period between two spells of rain is short.

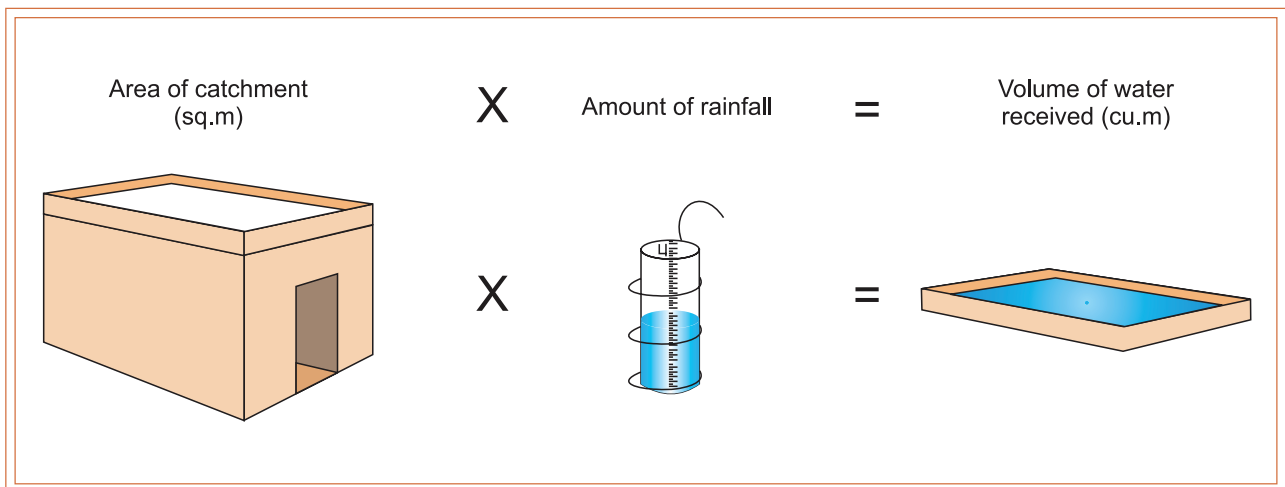

On the other hand, in dry areas like Delhi, Rajasthan and Gujarat, the total annual rainfall occurs only during 3 or 4 months of monsoon. The water collected during the monsoon has to be stored throughout the year; which means that huge volumes of storage containers would have to be provided. It is then more feasible to use rainwater to recharge ground water aquifers rather than for storage.

### Comparison Between Rainfall Pattern of Aizawl (Mizoram) and Delhi

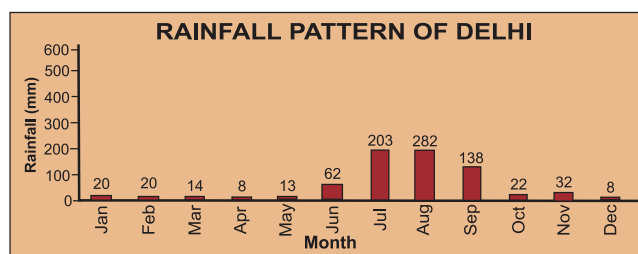
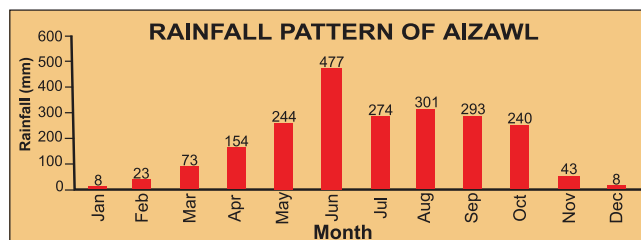

Source: A Water Harvesting Manual for Urban Areas

**Box 2.2 Potential of Water Availability through Rooftop RWH in Delhi (North India)**

The national capital territory NCT of Delhi receives 611 mm of rainfall on an average annually and the number of rainy days are as low as 20-30. (A rainy day is specified as a day with more than or equal to 2.5 mm of rainfall). The geology of Delhi comprises Alwar quartzites and alluvium whose vertical hydraulic conductivity, (permeability), is high compared to the horizontal permeability. This makes the conditions favourable for artificial recharge. Thus most of the urban rainwater harvesting efforts revolve around recharge of aquifers which is the best option available taking into consideration the rainfall pattern and availability.

Proposed category of area for 2011 (sq.km)		Annual water harvesting potential in billion litres	
		100 per cent harvesting	50 per cent harvesting
Development area	597.0	579.10	289.55
Green Belt	682.0	661.54	330.77
Total area	1279.0	1240.64	620.32

*Note: Average annual rainfall 970mm; Annual demand-supply gap 49.28 billion litres*

Roof area in sq.m	Annual rainfall in (litres)	Quantity of rainfall available for harvesting (litres)
50	30,550	18,330
100	61,100	36,660
500	305,500	183,300
1000	610,000	366,600

*(Note: a. Annual average rainfall of Delhi=611 mm; b. runoff coefficient is assumed as 0.60)*

An analysis of demand supply gap shows that even 50 per cent of the rainwater harvested can bridge the demand supply gap.

## The Contribution of Water to a Sustainable Water Strategy

Many cities around the world obtain their water from great distances - often over 100 km away. But this practice of increasing dependence on the upper streams of the water resource supply area is not sustainable. Building dams in the upper watershed often means submerging houses, fields and wooded areas. It can also cause significant socio-economic and cultural impacts in the affected communities. In addition, some existing dams have gradually been filling with silt. If not properly maintained by removing these sediments, the quantity of water collected may be significantly reduced. When the city increases the degree of dependence on a remote water resource, and there is a long period without rainfall in the upstream dam sites, the ability of the city to function effectively is seriously compromised. The same can be said about a city's reliance on a pipeline for drawing water from a water resource area to the city. A city which is totally reliant on a large, centralised water supply pipeline (or "life-line") is vulnerable in the face of a large-scale natural disaster. A shift from "life-line" to decentralised "life-points" should be encouraged. Numerous scattered water resource "life-points" within a city are more resilient and can draw on rainwater and ground water, providing the city with greater flexibility in the face of water shortages and earthquakes.

In addition to that, sustainability of urban water supply requires a change from coping with water supply without controlling demand, to coping with supply by controlling demand. The introduction of demand side management encourages all citizens to adopt water conservation approaches, including the use of freely available,

locally supplied rainwater. In addition to this, for sustainable use of ground water, it is necessary to consider the storage capacity for ground water over time. If this is neglected and ground water is extracted too quickly, it will disappear within a short time.

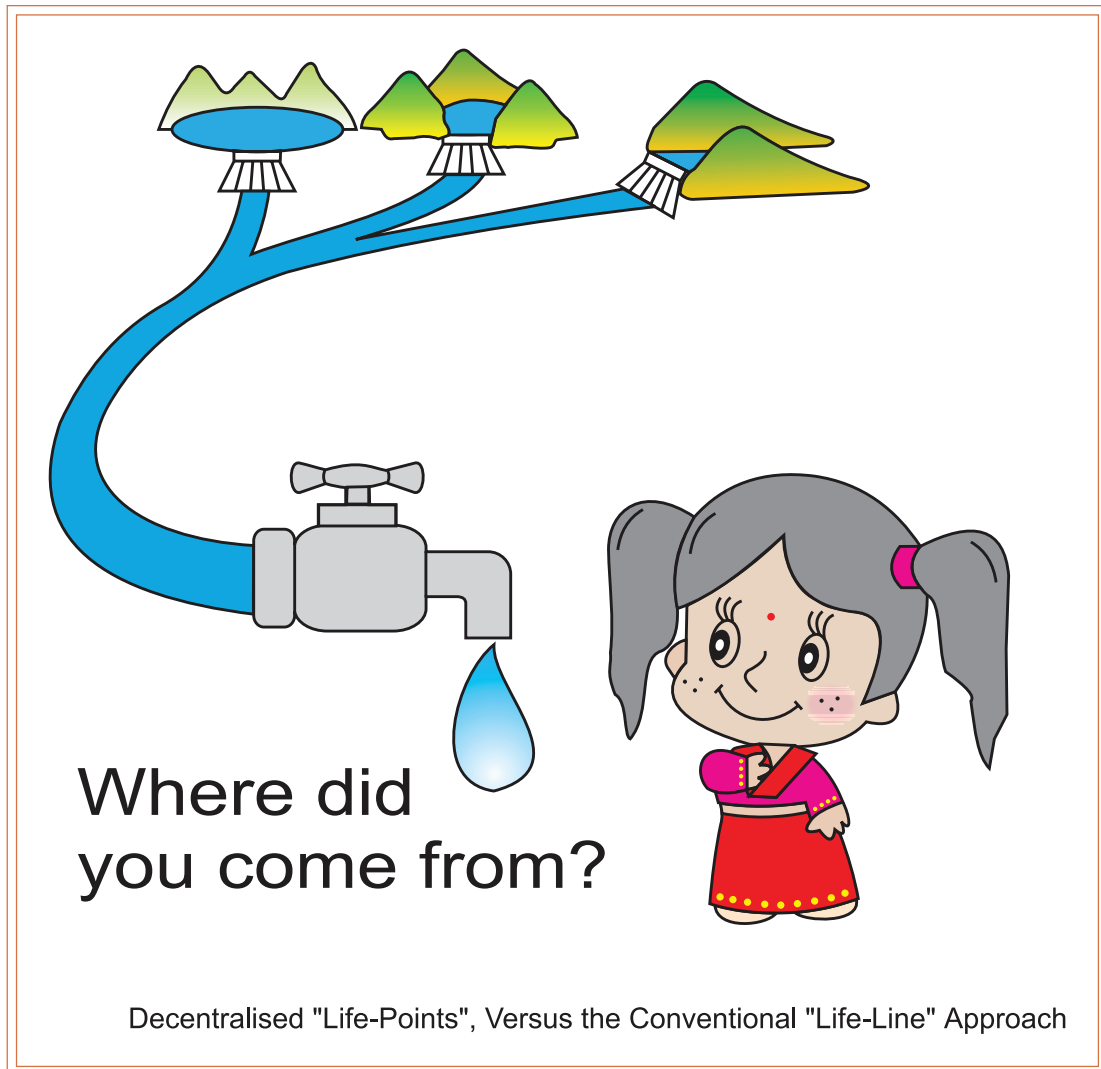

### Between Various Approaches Towards Water Management

Domestic Rooftop Water Harvesting (DRWH) Approach	Ground Water Recharge (GWR) Approach	Water Conservation and Recycling (WC&R) Approach	Municipal Supply Augmentation
<p><b>Owner's involvement</b></p> <p>Initially run as a people's self initiated without the govt's. explicit consent, with support of NGOs or community groups.</p> <p>Predominantly private investment with some subsidy from the govt.</p>	<p>Recharge from public areas dependent on government initiative with support of the public.</p> <p>Predominantly govt. investment with some private involvement for repair of conduits in houses.</p> <p>Lowest cost/kilolitre of supply as compared to other cases.</p>	<p>Usually people-initiated, with information and technology help from various sources.</p> <p>Some householder investment but primarily behavioral changes.</p>	<p>Purely govt. initiated creation of large systems.</p> <p>Fully govt. funded with investments required</p>
<p><b>Key issues</b></p> <p>Power requirement for pumping up in the ground.</p>	<p>Main expense in creating percolation wells/trenches or any other method.</p> <p>Maintenance is mainly of recharge pits, filtration pits which needs more involvement but not as often as DRWH.</p>	<p>Demand reduction rather than supply management. Conservation at source leads to overall saving in pumping power requirement and expenses.</p>	<p>As municipal supply based on ground water cost reductions forces</p>
<p><b>Key considerations</b></p> <p>Investing in water storage facility and creating proper conduits.</p>	<p>In areas of seasonal rainfall, a GWR system caters to demand for many more months as compared to the DRWH system.</p> <p>Directly mitigates ground water depletion.</p>	<p>Main expense can vary (filtration, tank) as per the method utilized. Program cost and emphasis on people mobilization, training and literature.</p> <p>Low maintenance, as predominantly behavioral changes.</p>	<p>Large govt. investment materials, manpower</p> <p>Govt. maintenance costs/manpower.</p>
<p>Dependence on seasonal rainfall, a standalone system caters to demand for only a few months than the rainfall months. Works in conjunction with GWR.</p> <p>Dependence on household/building owners and ground water</p>	<p>Most effective system and as a starting pilot for a community level initiative. Could be combined for high efficacy for a second phase DRWH system.</p> <p>Does not work at the individual level.</p>	<p>This system is beneficial both for individual households/reduces demand in overall water supply system. But overall benefits are related to widespread usage.</p> <p>Reduces dependence on ground water extraction.</p> <p>Works out to be best system if integrated with GWR &amp; DRWH system. In conjunction, it could take care of the complete demands of the project area.</p> <p>Difficult to make people accept behavioral changes and recycling of water if no other incentives present.</p>	<p>Large body of experience in ineffective schemes.</p> <p>Municipal supply based, so constant demand</p> <p>No relation with an initiative. Works if govt. commitment are present.</p> <p>Usually always lags projections.</p>
<p>Overall, as compared to the DRWH system.</p>			



# Harvesting Rainwater for Direct Use

**All sources of water are ultimately rain.** Therefore, all water supply systems are, in effect, rainwater-harvesting systems. A proper definition for this term to understand its spirit would, in effect, necessarily have to take into consideration the difference in catchments. While previously catchments were typically far from the urban area they served, now the city itself is seen as a catchment for its water requirement. Rooftops, paved and unpaved areas and the entire city itself is, therefore, to be managed as a water provision area. As the Centre for Science and Environment, Delhi puts it, 'CATCH WATER WHERE IT FALLS' would be a good definition of rainwater harvesting.

## Scale of Operations

From a small rooftop to large areas such as that of institutions and industries, rainwater harvesting can work well. Neighborhoods and finally the city itself should be the ultimate scale of operation. Singapore, for example,

**Chart 3.1: Water Flows Within the Urban Ecosystem**

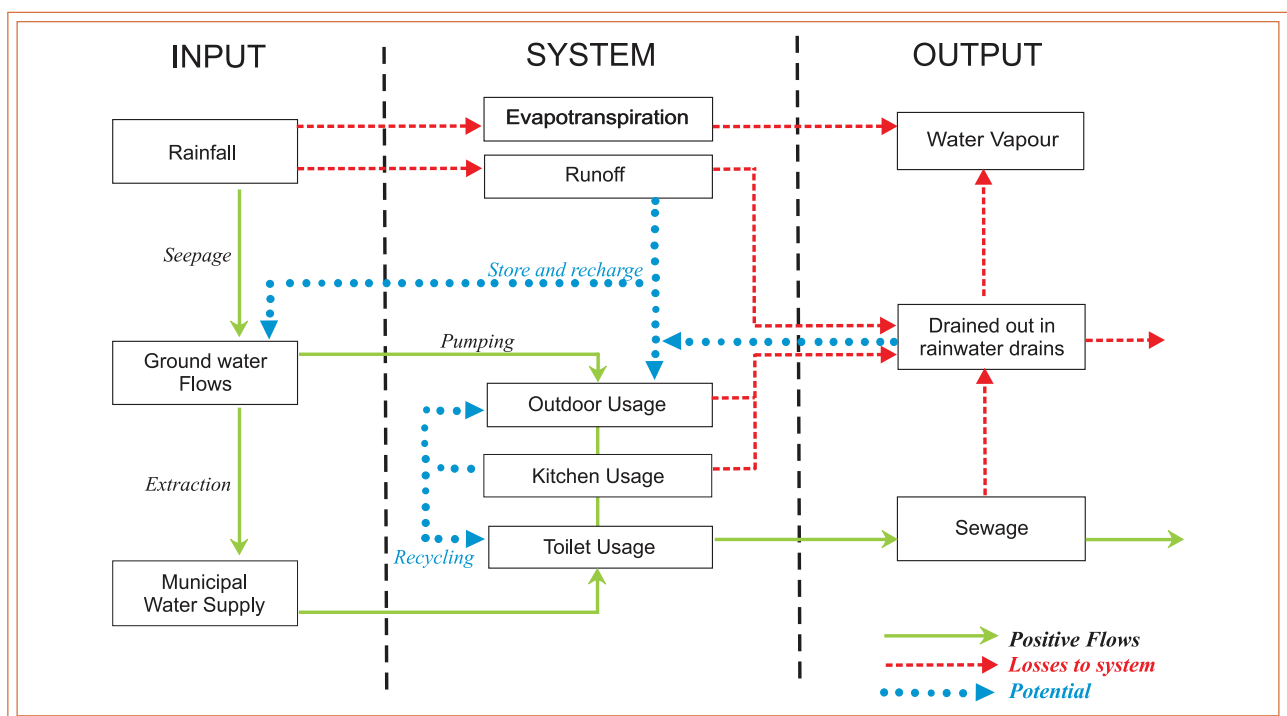

plans to manage and harvest almost all rainwater at the city-level. One primary step would be to keep the catchments clean and this would mean managing all solid, liquid and gaseous waste streams of the city. There are many methods for rainwater harvesting. Each method is site specific. The flow from roofs of houses may also be collected using galvanized iron sheets, into a channel fitted on the edge of the roof. This water can be stored adjacent to the house after screening out the impurities.

## Components of a Rainwater Harvesting System

All rainwater-harvesting systems comprise six basic components irrespective of the size of the system.

1. **Catchment Area/Roof:** The surface upon which the rain falls; the roof has to be appropriately sloped preferably towards the direction of storage and recharge.
2. **Gutters and Downspouts:** The transport channels from catchment surface to storage; Gutters and/or Down pipes have to be designed depending on site, rainfall characteristics and roof characteristics.
3. **Leaf screens and roof washers:** The systems that remove contaminants and debris; a first rain separator has to be put in place to divert and manage the first 2.5 mm of rain.
4. **Cisterns or storage tanks:** Sumps, tanks etc. where collected rain-water is safely stored or recharging the Ground water through open wells, bore wells or percolation pits etc.;
5. **Conveying:** The delivery system for the treated rainwater, either by gravity or pump;
6. **Water treatment:** Filters to remove solids and organic material and equipment, and additives to settle, filter, and disinfect.

Briefly the system involves collecting water that falls on roof of a house made of zinc, asbestos or other material during rain storms, and conveying it by an aluminium, PVC, wood, plastic or any other local material including bamboo drain or collector to a nearby covered storage unit or cistern. Rainwater yield varies with the size and texture of the catchment area. A smoother, cleaner and more impervious roofing material contributes to better water quality and greater quantity.

Each component is briefly described below.

### Catchment Surface

The catchment area of a water harvesting system is the surface, which receives rainfall directly and contributes the water to the system. It can be a paved area like a terrace or courtyard of a building, or an unpaved area like a lawn or open ground. Temporary structures like sloping sheds can also act as catchments. In Botswana, house compounds and threshing floors are surfaced with clay/cowdung plaster and used effectively as rainwater catchments. Rainwater harvested from catchment surfaces along the ground, because of the increased risk of contamination, should only be used for non-potable uses such as lawn watering. For in-house uses, rooftop harvested rainwater is safer for drinking purposes than the runoff harvested water.

### Catchment Area Size

The size of a roof catchment area is the building's footprint under the roof. The catchment surface is limited to the area of roof which is guttered. To calculate the size of the catchment area, multiply the length times the width of the guttered area. To calculate catchment area of a roof that is guttered only on one side, multiply the length times half the width; if it is fully guttered, use the total width. It is not necessary to measure the sloping edge of the roof.

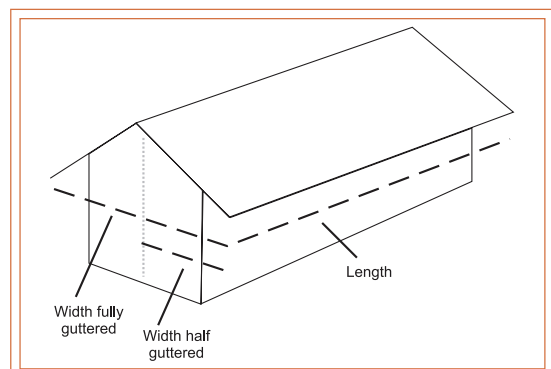

### Run-off

Runoff is the term applied to the water that flows away from a catchment after falling on its surface in the form of rain. Runoff can be generated from both paved and unpaved catchment areas of buildings.

### Runoff Coefficient

Runoff coefficient is the factor, which accounts for the fact that all the rainfall falling on a catchment cannot be collected. Some rainfall will be lost from the catchment by evaporation and retention on the surface itself. (Refer Table 3.1 for runoff coefficient).

### Type of Roofing Material

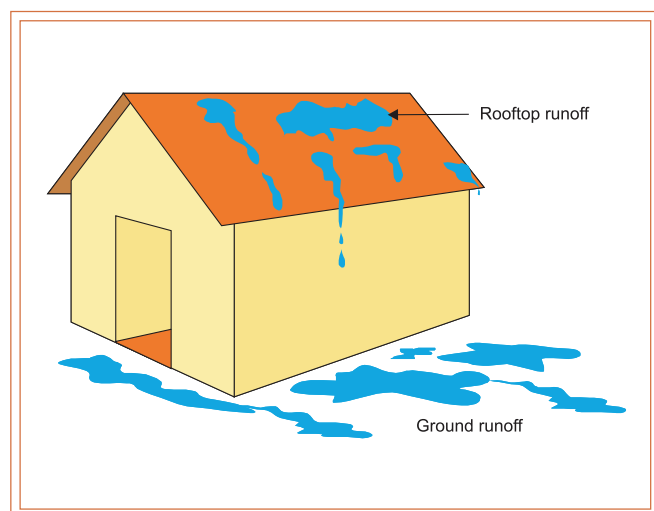

Runoff from a surface

Rainwater may be collected from any kind of roof. Tiled or metal roofs are easier to use, and may give clean water, but it is perfectly feasible to use roofs made of palm leaf or grass thatch. The only common type of roof which is definitely unsuitable, especially to collect water for drinking, is a roof with lead flashings, or painted with a lead-based paint. It is suggested that roofs made of asbestos sheeting should also not be used if fibres are getting detached from damaged areas. In the Khon Kaen province of Thailand, many well-constructed houses have corrugated iron roofs which are used for collecting rainwater. Roof areas are large, often exceeding 100 m<sup>2</sup>, though guttering may be installed on half the area.

### Gutters and Downspouts/Conduits

Conduits are the pipelines or drains that carry rainwater from the catchment or rooftop to the harvesting system. Conduits may be of any material like Poly Vinyl Chloride (PVC), asbestos or Galvanized Iron (GI); materials that are commonly available.

Table 3.1 gives an idea about the diameter of pipe required for draining out rainwater based on rainfall intensity (average rate of rainfall in mm per hour) and roof surface area

Channels have to be all around the edge of a sloping roof to collect and transport rainwater to the storage tank. Gutters can be semi-circular or rectangular and could be made using:

- ❖ Locally available material such as plain galvanised iron sheet (20 to 22 gauge), folded to the required shapes.
- ❖ Semi-circular gutters of PVC material which can be readily prepared by cutting the pipes into two equal semi-circular channels.
- ❖ Bamboo or betel trunks cut vertically in half.

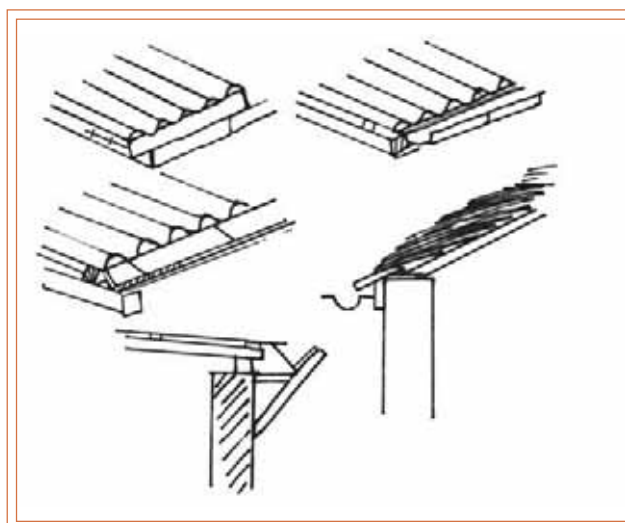

A variety of guttering types showing possible fixings

**Table 3.1: Sizing of Rainwater Pipes for Roof Drainage**

Sl. No.	Diameter of Pipe (mm)	Average rate of rainfall in mm/h					
		50	75	100	125	150	200
1.	50	13.4	8.9	6.6	5.3	4.4	3.3
2.	65	24.1	16.0	12.0	9.6	8.0	6.0
3.	75	40.8	27.0	20.4	16.3	13.6	10.2
4.	100	85.4	57.0	42.7	34.2	28.5	21.3
5.	125	-	-	80.5	64.3	53.5	40.0
6.	150	-	-	-	-	83.6	62.7

Roof area (sq.m.)

Source: Indian National Building Code

mm/h - millimeters per hour; m - meters

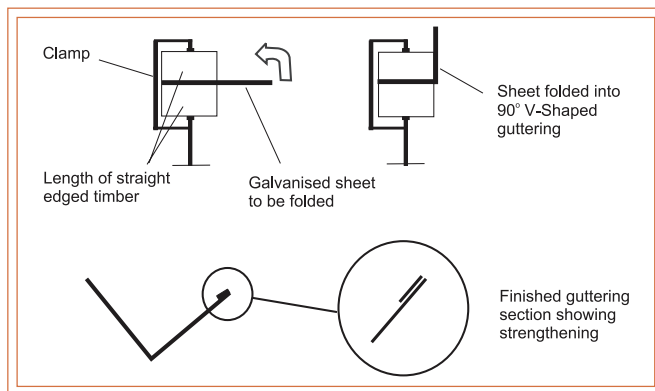

Folding galvanised steel sheet to make V-shaped guttering



A typical corrugated iron steel roof showing guttering  
Ref: Intermediate Technology Development Group, UK

### Leaf Screens/Roof Washers

To keep leaves and other debris from entering the system, the gutters should have a continuous leaf screen, made of 1/4 inch wire mesh in a metal frame, installed along their entire length, and a screen or wire basket at the head of the downspout. Gutter hangers are generally placed every 3 feet. The outside face of the gutter should be lower than the inside face to encourage drainage away from the building wall. Where possible, the gutters should be placed about 1/4 inch below the slope line so that debris can clear without knocking down the gutter.

To prevent leaves and debris from entering the system, mesh filters should be provided at the mouth of the drain pipe (see figure on following page). Further, a first-flush (foul flush) device section should be provided in the conduit before it connects to the storage container. If the stored water is to be used for drinking purposes, a sand filter should also be provided. (See section: Disinfecting water at domestic level)



One example of a flat screen over the gutter to keep large debris out of the tank. A problem with gutter screens is that they require a lot of maintenance to keep leaves and debris from piling up and blocking the screens. Also, dirt on the leaves can still be washed into the storage tank.



**First Flush Device**

A first flush (foul flush) device is a valve that ensures that runoff from the first spell of rain is flushed out and does not enter the system. This needs to be done since the first spell of rain carries a relatively larger amount of pollutants from the air and catchment surface.

Due to the extra cost of installing, any elaborate device and the near impossibility of maintaining it in rural situations, most programmes do no more than provide a screen of filter at the entry to the tank to prevent the grosser forms of debris from passing. In Indonesia, an inlet filter moulded in the tank roof is a prominent feature of the RWH system design. No specific provision is made for first flush diversion, but the length of guttering which takes the place of down pipe can be moved during any dry period and replaced after the first few minutes of rain in a new wet season.

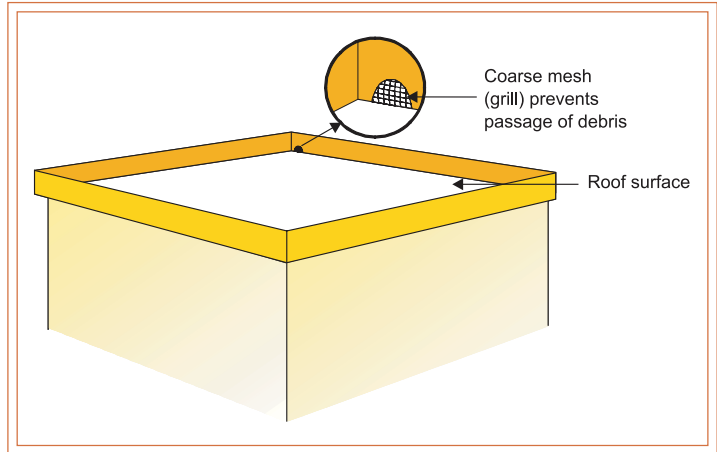

replaced after the first few minutes of rain in a new wet season. In Thailand RWH system incorporates a device for holding back first flush water. It consists of a length of large diameter pipe suspended alongside the rainwater tank.

This is sealed at the bottom with a plug. When rain begins to fall, this length of pipe must fill before any water can enter the tank. It will, thus, retain any sediment carried by the first flush water. After each storm, the plug is removed and the pipe is drained. Also consider trimming any tree branches that overhang the roof. These branches are perches for birds and produce leaves and other debris.

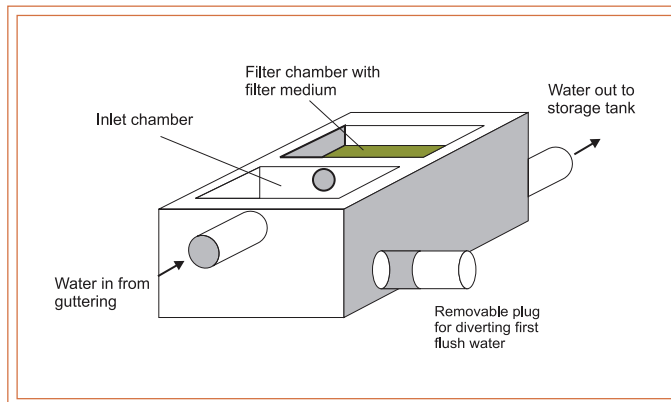

First flush device using removable plug for diverting first flush water (above) and using diversion pipe (below)

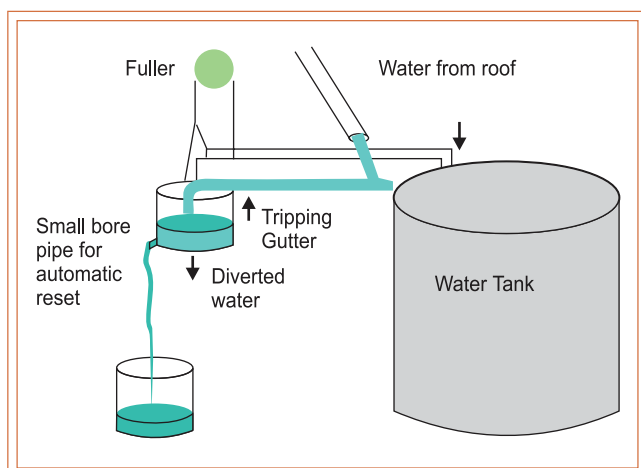

The Tripping Gutter first-flush system

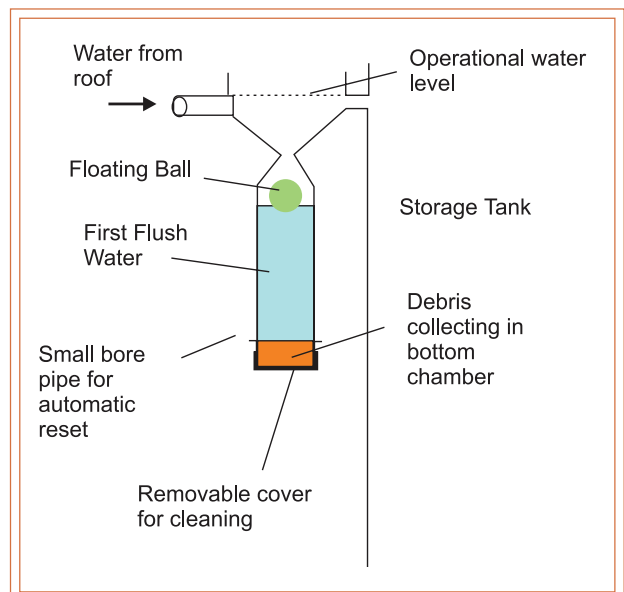

The floating ball first-flush system

## Storage Tanks/Cisterns

Storage tanks for collecting rainwater may be located either above or below the ground. They may be constructed as part of the building, or may be built as a separate unit located some distance away from the building.

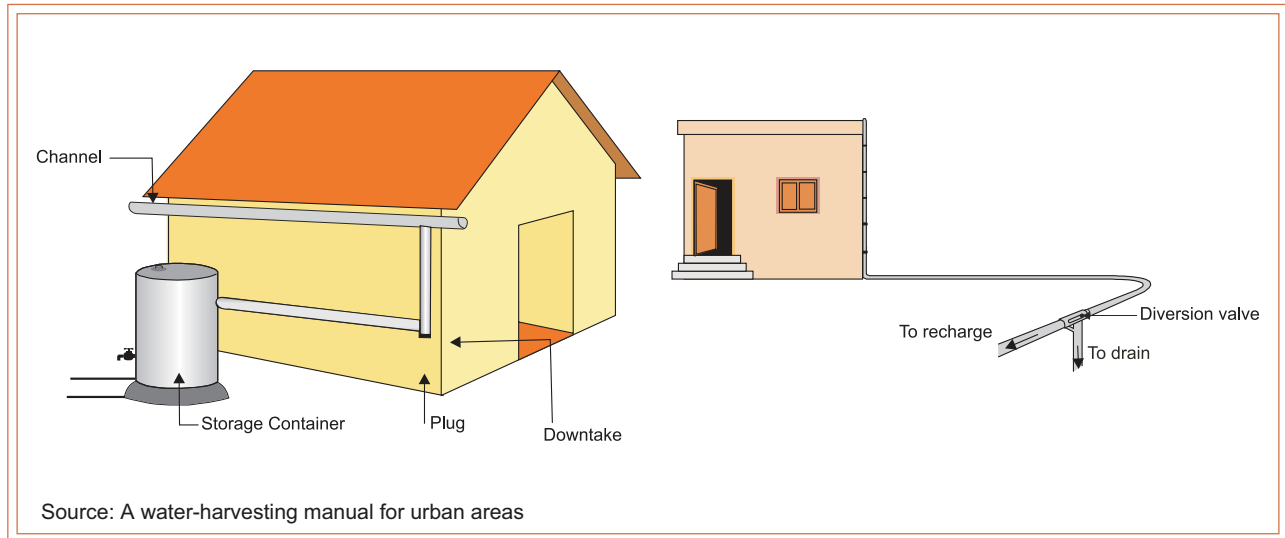

### Storage Cover

Open containers are not recommended for storing water for drinking purposes.

### Cleaning and Repair of Storage Tanks

The storage tank should be checked and cleaned periodically. All tanks need cleaning and their designs should allow for thorough scrubbing of the inner walls and floors. The extraction system (e.g., taps/faucets, pumps) must not contaminate the stored water. Taps/faucets should be installed at least 10 cm above the base of the tank as this allows any debris entering the tank to settle on the bottom, where if it remains undisturbed, will not affect the quality of the water. The following devices are also desirable:

- ❖ An overflow pipe leading to either infiltration plants, drainage pipes with sufficient capacity or the municipal sewage pipe system.
- ❖ An indicator of the amount of water in the storage tank
- ❖ A vent for air circulation (often the overflow pipe can substitute)
- ❖ Protection against insects, rodents, vermin, etc. may also be required.

### Roofs for Storage System

- ❖ Prevent nearly all evaporation
- ❖ Protect potable water from contamination and algae growth;
- ❖ Prevent the breeding of mosquitoes – but only if all openings to the air are screened with mosquito mesh;
- ❖ Can be exposed or buried (buried roofs must be very strong to withstand the weight of a vehicle);
- ❖ Flat roofs are often made from reinforced concrete (RC) slabs. Larger spans need RC beams and column supports;

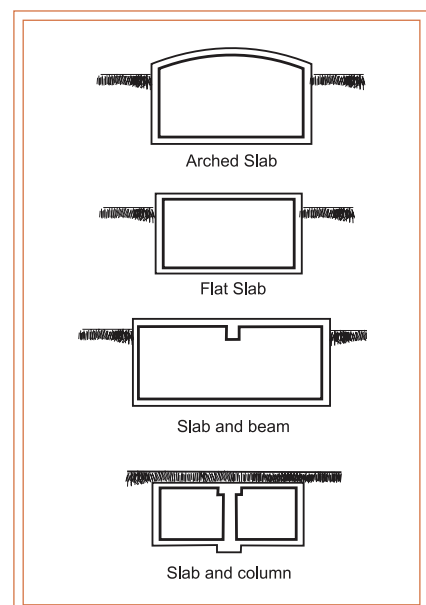

- ❖ Thin, domed ferrocement roofs are usually more cost-effective than flat roofs – they utilize the high compressive strength of the cement mortar. The mortar is reinforced with welded and woven wire meshes; and
- ❖ Lightweight materials such as corrugated iron can also be used for exposed roofs, but timber supports are not recommended, as they are liable to rot.

Ref: *Water and Environmental Health at London and Loughborough*

### Calculation of Required Storage Size

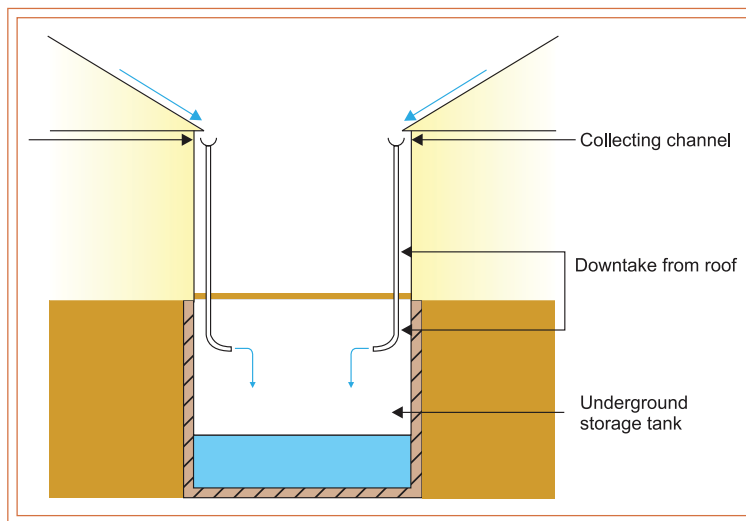

Rainwater can be stored in underground tanks as in this traditional rainwater harvesting system in Ahmedabad

When using rainwater, it is important to recognize that the rainfall is not constant throughout the year; therefore, planning the storage system with an adequate capacity is required for the constant use of rainwater even during dry periods.

In Ahmedabad (Gujarat, West India), which has a climate similar to that of Delhi, traditional rainwater harvesting tanks, which store drinking water, can be seen even today in some old houses. Rainwater can be stored in any commonly used storage containers like RCC, masonry or plastic water tanks. Some maintenance measures like cleaning and disinfection are required to ensure the quality of water stored in the container.

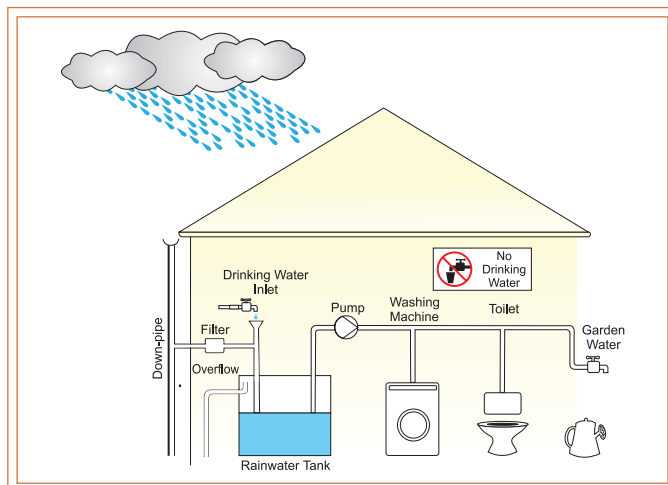

Particular care must be taken to ensure that potable water is not contaminated by the collected rainwater

### Shape

There are various options available for the construction of these tanks with respect to the shape, size and the material of construction. Shapes may be cylindrical, rectangular and square. The most commonly used material of construction is Reinforced Cement Concrete (RCC), ferrocement, masonry, plastic (polyethylene) or metal (galvanised iron).

In Thailand tanks are made of bamboo-reinforced concrete and are of varying sizes from 1.4 m<sup>3</sup> (costing about US \$25) to 11.3 m<sup>3</sup> (US \$175). Table 3.3 gives some of the recommended rainwater capacities based

on the assumption that water consumption can be returned to ensure an all year supply. The cisterns built in Indonesia and Thailand and the Ghala tank in Kenya, using bamboo reinforcement instead of metal, have been highly significant in making low-cost tanks, though their durability needs to be improved upon.

### Material for Construction

**Concrete:** Reinforced concrete tanks can be built above or below ground by a commercial contractor or owner builder. Because of their weight, they are usually poured in place to specifications and are not portable. However,

**Table 3.2: Relative Merits of Some Common Tank Shapes**

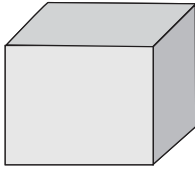
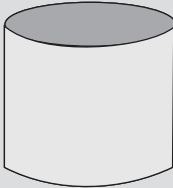
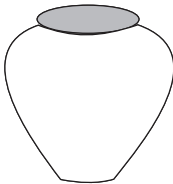
Tank Shape or Type		Material Usage	Construction
<b>Cuboid</b>		The ratio between material usage and storage capacity is higher than for a cylindrical or doubly curved tank	Construction is quite simple using most materials
<b>Cylindrical</b>		There is an improvement in the material use to storage capacity ratio (a saving of 7.5% over a similarly proportioned cuboid)	Construction becomes more difficult with some materials e.g. bricks, but the shape is well suited to construction with materials that can be bent e.g. ferrocement and GI sheeting or built in sections
<b>Doubly curved tanks (e.g. Thai Jar)</b>		Material usage to capacity ratio is very good (savings of up to 20% over a cuboid)	Construction can be difficult, often relying on specialized moulds. Materials must be pliable and able to curve in two directions e.g. ferrocement and clay

Ref: Development Technology Unit, School of Engineering, Univ. of Warwick, UK

concrete tanks can also be fashioned from prefabricated components, such as septic tanks and storm drain culverts, and from concrete blocks. Concrete is durable and long lasting, but is subject to cracking; below ground tanks should be checked periodically for leaks, especially in clayey soils where expansion and contraction may place extra stress on the tank. An advantage of concrete cistern chambers is their ability to decrease the corrosiveness of rainwater by allowing the dissolution of calcium carbonate from the walls and floors.

An underground RCC/masonry tank can be used for storage of rainwater. The tank can be installed inside the basement of a building or outside the building. Pre-fabricated tanks such as PVC can be installed above the ground. Each tank must have an overflow system for situations when excess water enters the tank. The overflow can be connected to the drainage system.



A wooden water tank in Hawaii, USA

- ❖ As the water inlet is connected to the tank at the ground level, the water inlet wall should not be raised above surface level.
- ❖ The mud filters are attached to the water inlet. Hence, the door has to be sturdy. As depicted in the picture on the next page, a concrete slab measuring 0.75m x 1m (height and length) should be laid near the door.

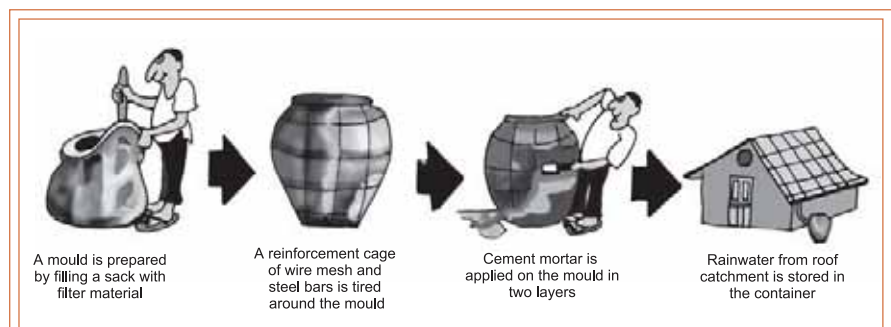

Ferrocement tanks to capture rainwater

**Ferrocement:** Ferrocement is a term used to describe a relatively



### Constructing a Brickwork Underground Rainwater Harvesting Tank – Stepwise



Measurement taken for radius of the tank



Pit for the tank construction

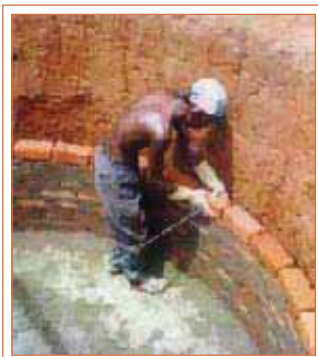

Wall construction of the tank on the concrete base



Measurement taken for the inlet construction



Concrete base for the inlet construction



After the completion of the rainwater harvesting tank

Ref: UNE, International Environment Technology Centre

low cost steel mortar composite material. Its use over the past 100 years has been most prevalent in developing countries in a range of low cost applications, such as water tanks. It has also gained popularity among do-it-yourself kind of technology. Although it is a form of reinforced concrete, its distinctive characteristics relative to performance, strength, and flexible design potentials generally warrant classification of ferrocement as a separate material. Unlike reinforced concrete, ferrocement's reinforcement is comprised of multiple layers of steel mesh (often chicken wire), shaped around a light framework of rebar, that are impregnated with cement

Table 3.3: Tank Capacities

Region	Average Annual Rainfall * (mm)	Sample Roof Area * (m <sup>3</sup> )	Recommended Tank Capacity (m <sup>3</sup> )	Estimated Daily Supply (litres)
<b>AFRICA</b>				
Ghana, N.E.region	800 in two wet seasons	30	7.5	66
Swaziland, Lowveld	635 with 6 dry months	30	5.0	37
Botswana Francistown	470 with 7-9 dry months	30	4.5	31
			4.5	66
			8.0	31
<b>INDONESIA</b>				
Java, Jakarta area	1800, no really dry months	30	1.2	30
			5.5	60
			3.6	30
			7.8	60
Madura	1500 with 5 dry months	30	5.1	30
Java, Yogyakarta	1800 with 6 dry months	30	5.0	30
<b>THAILAND</b>				
Khon Kaen area	1300 with 4 dry months	60	11.5	90
			30	45
<b>AUSTRALIA</b>				
Sydney	1210 no dry months	320	126	800
		30	11.8	74
Griffith, New South Wales	390 with no defined wet season	965	336	800
		30	10.5	25
<b>BERMUDA</b>				
	1500 no dry months	30	11.7	-

Source: Journal: Aqua (A-126)

mortar. Because its walls can be as thin as 1", it uses less material than conventional poured in place concrete tanks, and thus is generally much less expensive.

### Plastic

**Fiberglass:** Fiberglass tanks are lightweight, reasonably priced, and long lasting, making them among the most popular tanks in contemporary installations.

**Plastic Liner:** Plastic liners are sometimes used to line concrete tanks or tanks that have developed leaks.

**Polyethylene:** In many countries these tanks are commercially available in a variety of sizes, shapes, and colors, and can be constructed for above or below ground installations, and are considered quite durable.

### Metal

In the U.S. galvanised steel tanks are also used. These are commercially available and reasonably priced and are quite popular. They are noted for their strength, yet are relatively lightweight and easy to move. In some places – including parts of Kenya and Papua New Guinea – tank construction provides jobs for significant number of ‘tin-smiths’. Materials needed for the construction of some widely used types of rainwater tank are given in Table 3.4.

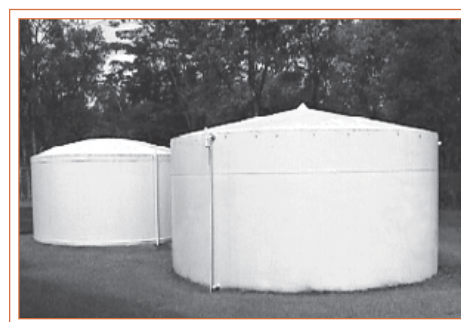

### Position of Tank

Depending on space availability, these tanks could be constructed above ground, partly underground or fully underground. Some maintenance measures like cleaning and disinfection are required to ensure the quality of water stored. Other than the roof, which is an assumed cost in most building projects, the storage tank represents the largest investment in a rainwater harvesting

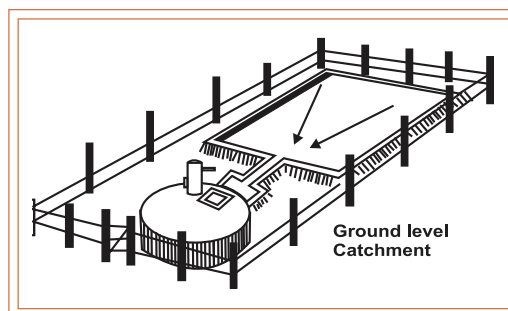

**Table 3.4: Materials for Rainwater Tanks**

	Unreinforced Cement Mortar Jar	Ghala Tank	Ferrocement Tank	Bamboo Reinforced Concrete Tank
Capacity	1.0 m <sup>3</sup>	2.3 m <sup>3</sup>	9.0 m <sup>3</sup>	11.3 m <sup>3</sup>
Local Materials	Rice husks, sawdust or sand to stuff sacking formwork	Woven stick granary basket—murrum or clay		
Special Requirement	Hessian Sacking 4m x 1.7 m		Corrugated Iron formwork.	Metal formwork
Cement (50 kg bags)	2 bags	5 bags	12 bags	13 bags
Sand	200 kg	500 kg	1300 kg	1300 kg
Gravel, 25 mm	—	200 kg	500 kg	2000 kg
Quarry chippings	—	300 kg	—	800 kg
Chicken wire 50 mm mesh.	—	—	16 m <sup>3</sup>	—
Straight wire 2.5 mm gauge.	—	—	200 m	—
Water pipe, 15 mm	—	1 m	2 m	1 m
Overflow pipe 50 mm	—	—	0.2 m	0.2 m
Taps	—	1 no.	1 no.	1 no.
Roof or lid	Made of wood or cement mortar	Cement mortar	6 m <sup>2</sup> sheet metal	Concrete
Bags of cement per m <sup>3</sup> storage	2.0	2.2	1.3	1.15

Source: Journal: Aqua (A-126)

## Box 3.1

## Advantages and Disadvantages of Underground Tanks

## Advantages

- ❖ If the soil is firm it will support the pressure acting on the walls of the tank so that cheaper walls - less robust than those of an above-ground tank - can be used;
- ❖ The tank is protected from the cracking which can result from the regular expansion and contraction caused by daily heating and cooling of exposed walls;
- ❖ The water in it remains cooler and is, therefore, more pleasant to drink; and
- ❖ Water can be collected from ground-level catchment areas.

## Disadvantages

- ❖ The source of any leakage is hard to detect and, therefore, hard to repair;
- ❖ Polluted water may leak into the tank particularly if the roof is buried;
- ❖ Drawing water from a tap (more hygienic than using a bucket and rope) is only possible if steps are provided to give access to a low-level tap in a trench immediately adjacent to the tank (see right). If the buried tank is on a hillside, however, water will gravitate to an above-ground tap (see below right).

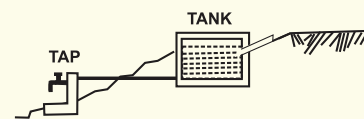
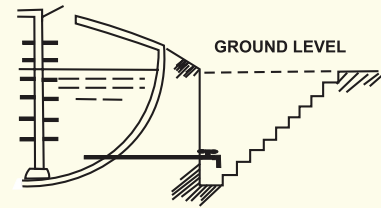

system. To maximize the efficiency of the RWH system, the building plan should reflect decisions about optimal placement, capacity, and material selection for the cistern/storage tank.

## Design Features of Storage Tanks

The quantity of water stored in a water harvesting system depends on the size of the catchment area and the size of the storage tank. The storage tank has to be designed according to the water requirements, rainfall and catchment availability.

*Design Parameters for Storage Tanks*

- ❖ Average annual rainfall
- ❖ Size of the catchment
- ❖ Drinking water requirement

Suppose the system has to be designed for meeting the drinking water requirements of a 5 member family living in a building with a rooftop area of 100 sq.m. Average annual rainfall in the region is 600 mm. Daily drinking water requirement per person (drinking and cooking) is 10 litres.

We shall first calculate the maximum amount of rainfall that can be harvested from the rooftop:

Following details are available:

Area of the catchment (A) = 100 sq.m.

Average annual rainfall (R) = 600 mm (0.6 m)

Runoff coefficient (C) = 0.85

Annual water harvesting potential from 100 sq.m. roof

$$\begin{aligned}
 &= A \times R \times C \\
 &= 100 \times 0.6 \times 0.85 \\
 &= 51 \text{ cu.m. (51,000 litres)}
 \end{aligned}$$

The tank capacity has to be designed for the dry period, i.e., the period between the two consecutive rainy seasons. With the rainy season extending over four months, the dry season is of 245 days.

Drinking water requirement for the family (dry season)

$$\begin{aligned}
 &= 245 \times 5 \times 10 \\
 &= 12,250 \text{ litres}
 \end{aligned}$$

As a safety factor, the tank should be built 20 per cent larger than required, i.e., 14,700 litres. This tank can meet the basic drinking water requirement of a 5 member family for the dry period.

Designing a system with two tanks provides some flexibility that may be of value. In most cases, an additional tank represents added cost, regardless of whether it represents increased capacity. This is because two smaller tanks of, for example 5,000 litres each, are generally more expensive than a single 10,000 litres tank. The primary benefit of a multi-tank system is that the water supply can remain operational if one tank has to be shut down due to maintenance or leakage.

### General Safety Guidelines for Storage Tanks/Cisterns

- ❖ A cistern must not be located closer than 50 feet from source of contamination, such as a septic tank.
- ❖ A cistern must be located on a grade lower than the roof washer to ensure that it can fill completely.
- ❖ A rainwater system must include installation of an overflow pipe which empties into a non-flooding area.
- ❖ Inlets to cisterns must be designed to dissipate pressure of influent stream and minimize the stirring of any settled solids.
- ❖ An aboveground roof washer or filtering device shall be provided on all cisterns.

### Table 3.5: Big vs. Small Tank: Cost Comparison

(Comparative cost of the one large tank collecting water from both sides of a roof as compared with two small tanks.)

(US \$)

	Large Tanks Collecting from Both Sides of a Roof	Two Small Tanks Each Collecting from One Side of the Roof
<b>Cost of Tanks:</b>		
10 m <sup>3</sup> size	100	—
5 m <sup>3</sup> size	—	56
Cost of guttering	57	17
Cost of down pipes	15	3
	172	132

Note: Figures are based on experience in Zimbabwe  
Source: Journal: Aqua (A-126)



Table 3.6: Comparative Cost for Rainwater Tanks

(US \$)

Type of Tank	Tank Capacity 2.5 m <sup>3</sup> Unit Cost per m <sup>3</sup>	Total Cost	Tank Capacity 9-10 m <sup>3</sup> Unit Cost per m <sup>3</sup>	Total Cost
Fibre glass	160	400	180	1800
Sheet metal	-	-	90	900
Galvanised corrugated iron	60	150	35	350
Ferrocement West Java type	38	94	20	200
Ferrocement Zimbabwe type materials only	-	-	15	150
Materials & Labour	-	-	22	220
Bamboo reinforced concrete (Thailand) materials only	-	-	14	135
Materials & Labour (contractors price)	-	-	32	360
Bamboo cement (West Java type)	28	70		
(Ghala tank Kenya) Materials only	18	45		

Source: Journal: Aqua (A-126)

- ❖ The water intake for a pump in a cistern should be attached to a floatation device and be located a minimum of 4 inches below the surface of the water.
- ❖ Overflow from rainwater systems should not flow into wastewater systems.
- ❖ Cisterns shall be accessible for cleaning.
- ❖ All openings into the cistern should be screened.
- ❖ Cisterns cannot be relied upon to provide potable water without adequate treatment consisting of roof washing and continuous disinfection.

### Cost of Storages

The criteria influencing the design of tanks for collecting rainwater from house roofs include the following:

- ❖ Cost
- ❖ Availability of materials (e.g. aggregate, bamboo, local brick)
- ❖ Employment opportunities
- ❖ 'Teachability' and the organisation of technical assistance
- ❖ Adequate curing of cement mortar
- ❖ Design tolerance for bad workmanship
- ❖ Possible supply of components from a central depot
- ❖ Hydrology as a check on maximum capacities

Low Cost Storage for Domestic Roofwater Harvesting

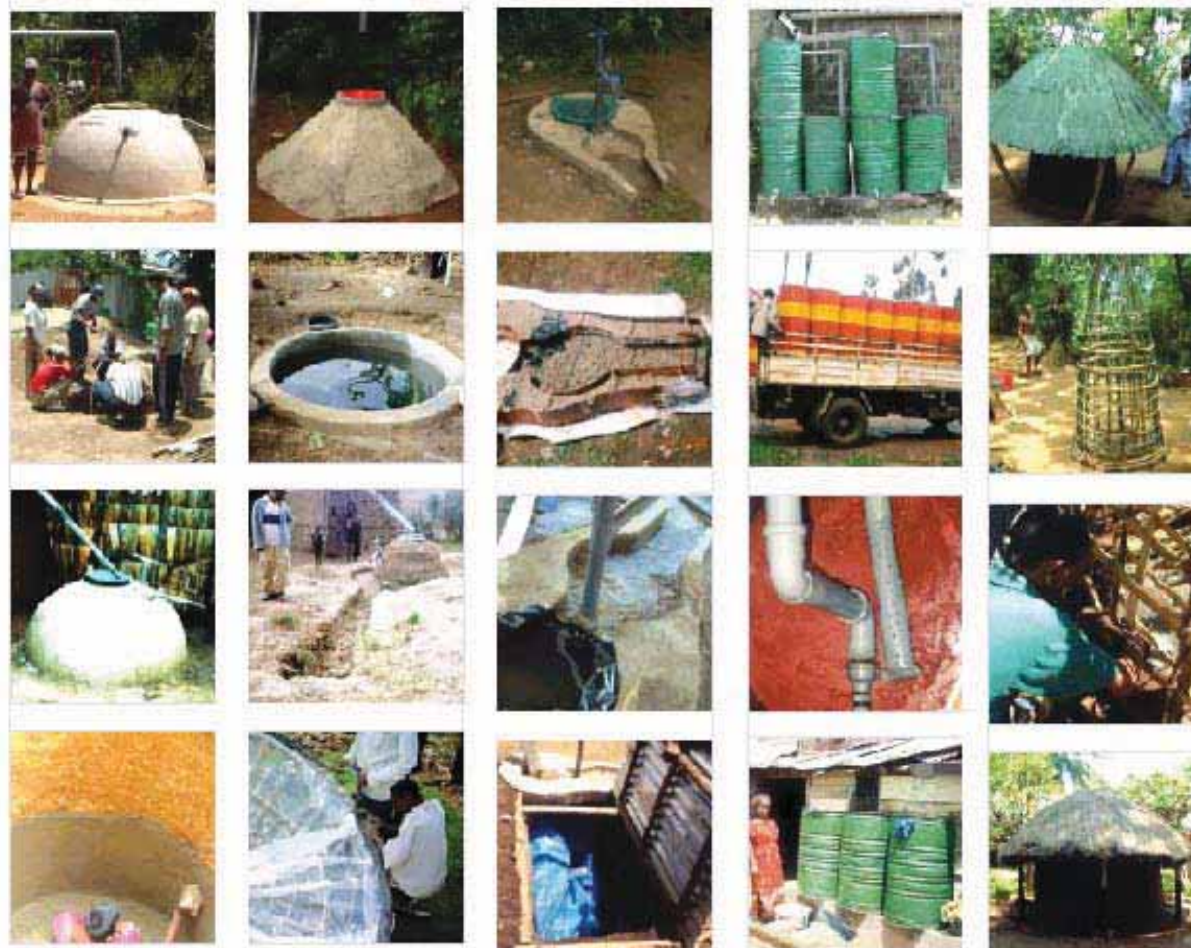

Dome                      ELMR                      TUBE                      Barrel                      Mud Tanks

	Tank Type	Details	Cost in US\$/Size of tank in litres							
			500	1,000	1,500	2,000	3,000	5,000	7,000	10,000
1	Dome tank	Ferrocement dome covering a mortar lined pit					60	80	110	120
2	Enhanced Local Material Roof (ELMR) (upgradable)	Mortar lined pit covered with roof made from local materials				45		65	75	
3	Tube tank	Concrete platter with a polythelene tube placed beneath		25	35					
4	Barrel tank	Quick to install, semi-portable tank, can incorporate filter too	60							
5	Mud tank	Structure & polythylene liner for waterproofing		30		45		90		

Ref: Development Technology Unit, School of Engineering, Univ. of Warwick, UK

### Comparative Parameters for Selecting Suitable Storage Tank

Type of Tank \ Parameters	Material costs	Percent Labour costs	Unit costs (per m <sup>3</sup> )	Skills required	Equipment/tools required	Space requirement	Suitability for incremental adoption	Reliability	Water quality, safety and health	Impact on insect breeding	Stage of maturity or experience
Pumpkin tank	✓	✓	✓	✗	✗	○	✗	✓	✓	✓	✓
Underground brick dome tank	✓	✓	✓	○	✗	✓	✗	✓	✓	✓	✓
Brick built storage tank	○	○	○	✓	✓	○	○	✓	✗	✗	✓
Partially below ground brick built tank	✗	✗	✗	✓	✓	○	✗	✓	✓	○	○
Underground storage cistern	✓	✓	✓	✗	✓	✓	○	✓	✓	✓	○
Ferrocement water tank using former	✓	✓	✓	✓	✗	○	○	✓	○	○	✓
RWH in the barrios of Tegucigalpa	○	○	○	✓	✓	○	✓	○	✗	✗	○
Tai jar	✓	✓	✓	○	✗	○	✓+	✓	✓	○	✓
Plastic lined tanks	✓+	✓+	✓+	✓+	✓	○	✗	?	○	○	✗

Key      ✓ Good      ○ Medium      ✗ Bad

### Water Treatment

Water can be unsatisfactory without being unsafe; therefore, filtration and some form of disinfection is the minimum recommended treatment if the water is to be used for human consumption (drinking, brushing teeth, or cooking). The types of treatment units most commonly used by rainwater systems are filters that remove sediment, in consort with either an ultraviolet light or chemical disinfection.

#### Types of Filtration Systems

##### Gravity Based Filter

This consists of construction of an underground / above ground filtration chamber consisting of layers of fine sand / coarse sand and gravel. Further deepening of the filter media shall not result in an appreciable increase in the rate of recharge and the rate of filtration is proportional to the surface area of the filter media. A unit sq.m. surface area of such a filter shall facilitate approx. 60 litres/hr of filtration of rainwater runoff. In order to determine the optimum size of the surface area just divide the total design recharge potential by this figure. A system of coarse and fine screen is essential to be put up before the rainwater runoff is allowed to flow into the filtration pit.

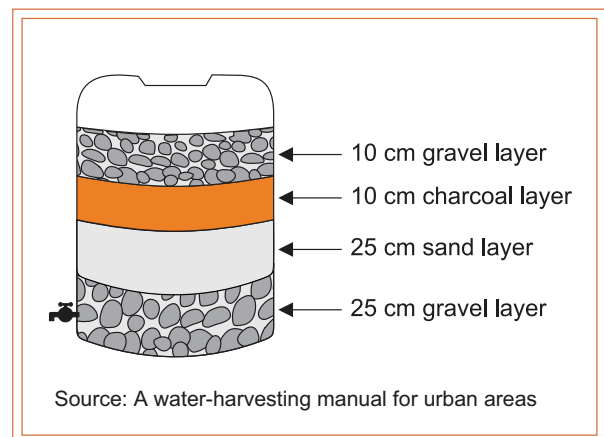

Sand filters are commonly available and are easy and inexpensive to construct. These filters can be employed for treatment of water to effectively remove turbidity (suspended particles like silt and clay), colour and microorganisms.

*Pressure Based Filter*

There are pressure based filters that facilitate higher rate of filtration in a pressurized system. It requires a siltation pit of about 6-15 cu.m. in capacity so as to facilitate sedimentation before it is pumped through the filter into the ground. Being a pressure based system it requires a pump of capacity 0.5-1 hp. The rate of filtration is evidently high and the quality of water is also claimed to be as per WHO guidelines. They are successful for areas with larger rainwater runoff (>6 cu.m./hr) and limited space availability. Also these filters can be put in combination with an existing tube well so as to recharge water into the same bore<sup>1</sup>.

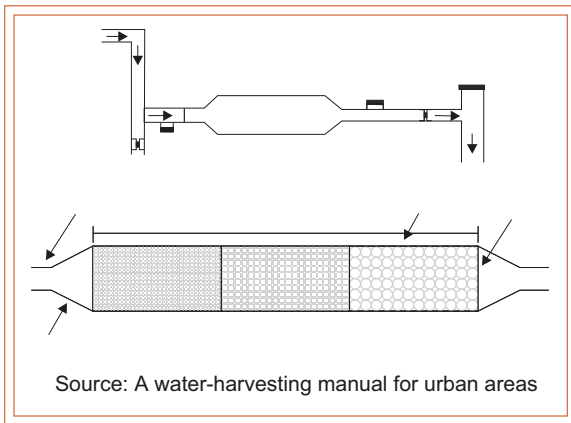
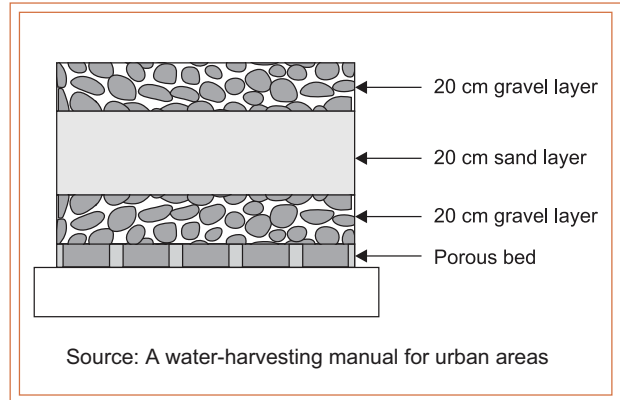

The filter mainly used for ground water recharge through the service tube well consists of a polyvinyl chloride (PVC) pipe 140 mm in diameter and 1.2 m long. There are three chambers. The first purification chamber has pebbles varying between 2-6 mm, the second chamber has slightly larger pebbles, between 6 and 12 mm and the third chamber has the largest - 12-20 mm pebbles. There is a mesh at the outflow side through which clean water flows out after passing through the three chambers. The cost of this filter unit is Rs 600 (US \$15). The filter has been locally developed and used in Dewas, Madhya Pradesh, India.

**Dewas Filters - Filter for Large Rooftops<sup>2</sup>**

When rainwater is harvested in a large rooftop area, the filtering system should accommodate the excess flow. A system is designed with three concentric circular chambers in which the outer chamber is filled with sand, the middle one with coarse aggregate and the innermost one with pebbles.

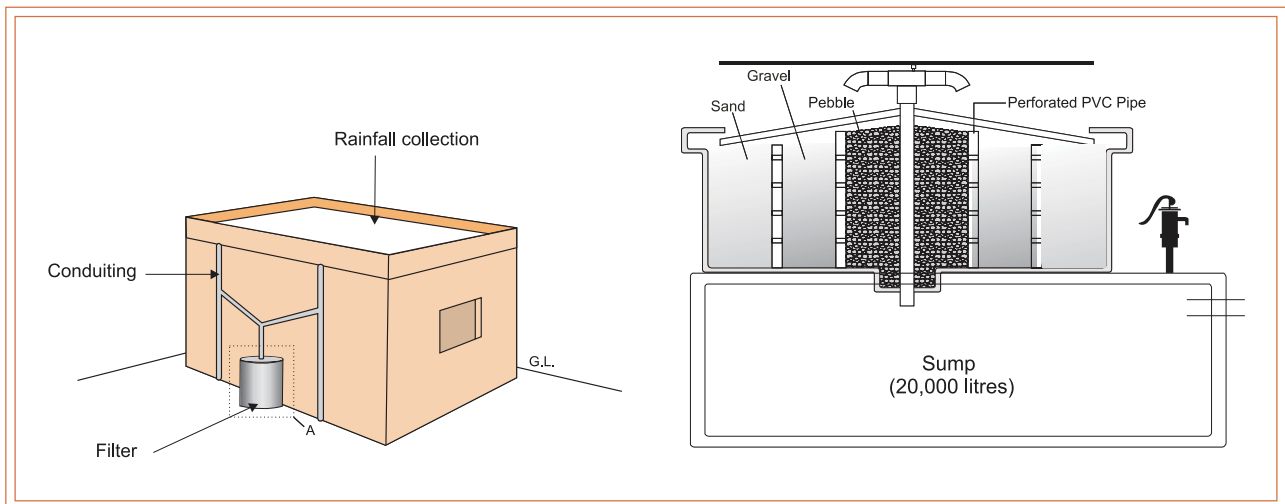

<sup>1</sup> Source: Seminar on RWH – Delhi Jal Board.

<sup>2</sup> Designed by R. Jayakumar Source: Rainwater Harvesting Manual.

This way the area of filtration is increased for sand, in relation to coarse aggregate and pebbles. Rainwater reaches the centre core and is collected in the sump where it is treated with few tablets of chlorine and is made ready for consumption.

### VARUN<sup>3</sup>

From a decently clean roof, 'VARUN', a rainwater filter, can handle a 50 mm per hour intensity rainfall from a 50 square metre roof area. This means the product is relatively standardised.

'VARUN' is made from a 90 litre High Density Poly Ethylene (HDPE) drum. The lid is turned over and holes are punched in it. This is the first sieve which keeps out large leaves, twigs etc. Rainwater coming out of the lid sieve then passes through three layers of sponge and a 150 mm thick layer of coarse sand. The presence of the sponge makes the cleaning process very easy. Remove the first layer of sponge and soak /clean it in a bucket of water (which you then don't waste but use it for plants). The sand needs no cleaning at all. The basic cost of the filter is about Rs 2250/- (US \$50)



**Table 3.7: Treatment Techniques**

Method	Location	Result
<b>Screening</b>		
Strainers and leaf screens	Gutters and leaders	Prevent leaves and other debris from entering tank
<b>Settling</b>		
Sedimentation	Within tank	Settles particulate matter
<b>Filtering</b>		
In-line/multi cartridge	After pump	Sieves sediment
Activated carbon*	At tap	Removes chlorine
Reverse osmosis	At tap	Removes contaminants
Mixed media	Separate tank	Traps particulate matter
Slow sand	Separate tank	Traps particulate matter
<b>Disinfecting</b>		
Boiling/distilling	Before use	Kills microorganisms
Chemical treatments (Chlorine or iodine)	Within tank or pump	Kills microorganisms (liquid, tablet or granule)
Ultraviolet light	Should be located after the activated carbon filter before trap	Kills microorganisms
Ozonation	Before tap	Kills microorganisms

\* Should only be used after chlorine or iodine has been used as a disinfectant. Ultraviolet light and ozone systems should be located after the activated carbon filter but before the tap.

<sup>3</sup> Developed by S. Vishwanath, a Bangalore water harvesting expert.



### Horizontal Roughing Filter and Slow Sand Filter

The introduction of horizontal roughing filter and slow sand filter (HRF/SSF) to treat surface water has made possible safe drinking water availability in coastal pockets of Orissa. The major components of this filter are described below.

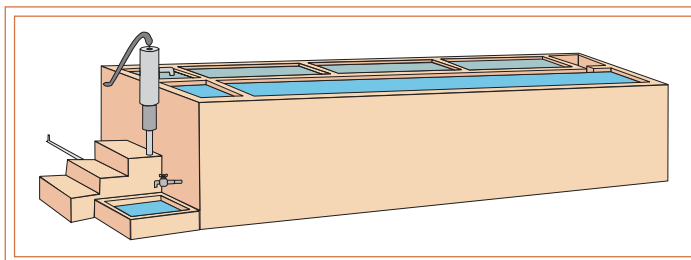

- ❖ **Filter channel:** One square metre in cross-section and eight meters in length, laid across the tank embankment, the filter channel consists of three uniform compartments, the first packed with broken bricks, the second with coarse sand, followed by fine sand in the third compartment. The HRF usually consists of filter material like gravel and coarse sand that successively decreases in size from 25 mm to 4 mm. This coarse filter media or HRF separates the bulk of solids in the incoming water. At every outlet and inlet point of the channel, fine graded mesh is implanted to prevent entry of finer materials into the sump. The length of a channel varies according to the nature of the site selected for the sump.
- ❖ **Sump:** A storage provision to collect filtered water from the tank through the filter channel for storage and collection.

While HRF acts as a physical filter and is applied to retain solid matter, SSF is primarily a biological filter, used to kill microbes in the water. Both filter types are generally stable, making full use of the natural purification process of harvested surface water and do not require any chemicals.

## Filters Developed in Other Countries

### Rain PC – A Filter Developed in the Netherlands

Rain PC is developed by scaling down the multi-staged water treatment method (MST), which involves screening, flocculation, sedimentation and filtration and incorporating existing technologies like upward flow fine filtration, absorption and ion exchange. The Rain PC, a small compact 26 kg unit offers an affordable solution by converting rainwater into drinking water.

The salient features of Rain PC are:

- ❖ Simple straight-forward installation
- ❖ Easy to operate and maintain
- ❖ Needs no power and operates at low gravity pressure (0.1 bar upward).
- ❖ The system is capable of providing a constant flow of about 40 litres of rainwater per hour, enough for a family of five for drinking, cooking and bathing purposes.
- ❖ Maintains nearly constant volume irrespective of water pressure.
- ❖ The Xenotex-A and activated carbon cartridge processes up to 20,000 litres and can be regenerated up to 10 times.
- ❖ Cost per 1000 litres is as low as US\$ 2 to 3.

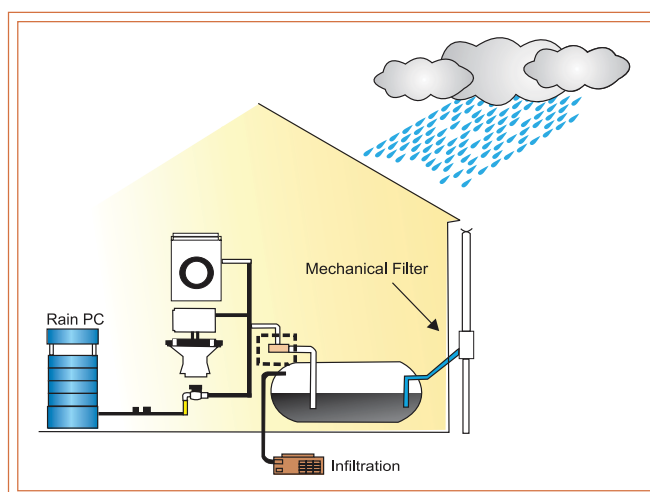

*(The above information is as per the manufacturers' claims) For further information Email: [cleanwater@aquasure.nl](mailto:cleanwater@aquasure.nl)*

## Filters Available in the German Market

### Filters Developed by WISY<sup>4</sup> - A Private German Company

Private companies such as WISY, based in Kefenrod in Germany, are playing an important role in promoting rainwater use by developing pumps and filter devices to improve water quality. WISY has developed a simple filter system, which can be attached to a standard household down pipe. Under conditions in Germany (assuming a mean annual rainfall of 650mm/year), this can divert and filter 90 per cent of the runoff from a roof area of up to 200 square metres.

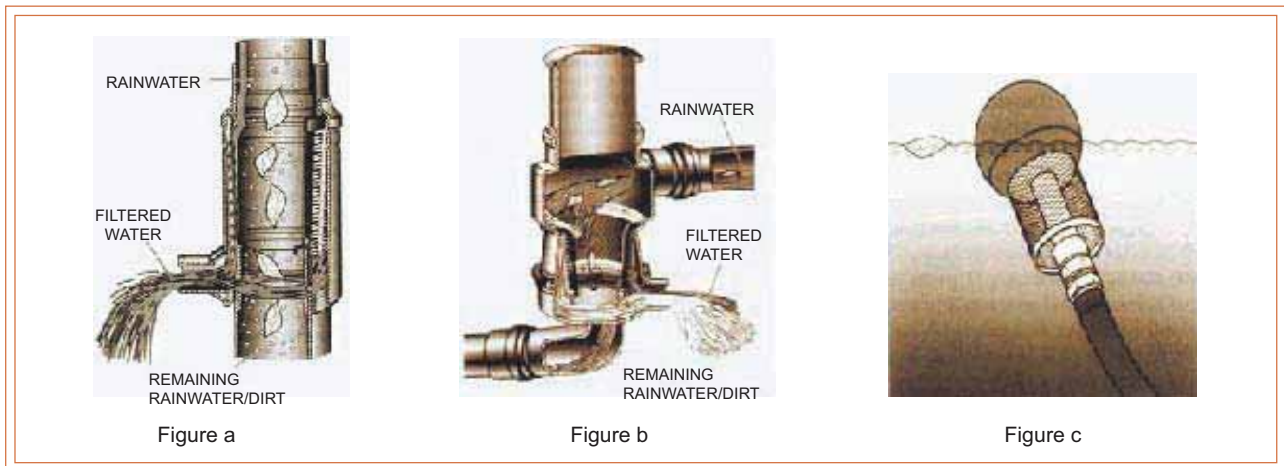

Figure a: A filter collector diverts 90 per cent of rainwater to a storage tank through a 0.17 mm stainless steel mesh filter.

Figure b: This larger vortex fine filter can cope with run-off from roof areas of up to 500 square metre.

Figure c: This floating fine suction filter has been developed for ensuring that the water pumped from the tank is extracted.

Source: John Gould and Erik Nissen-Petersen, 1999: *Rainwater Catchment Systems for Domestic Supply - Design, Construction and Implementation*, Intermediate Technology Group.

## Disinfection

### Quality of Stored Water

Rainwater collected from rooftops is free of mineral pollutants like fluoride and calcium salts which are generally found in ground water. But, it is likely to be contaminated with other types of pollutants:

- ❖ Air pollutants
- ❖ Surface contamination (e.g., silt, dust)

### Measures to Ensure Water Quality

Many institutions have concerns for quality and the high cost needed to make rainwater harvesting available in modern houses. Use of rainwater for purposes like gardening, cleaning and decentralized seepage is generally accepted. There are, however, reservations for using rainwater for drinking purposes. For rooftop harvesting the roofing material may affect the quality of rainwater on the roof. Some roof materials such as bitumen add unwanted organic chemicals to the water. The water from the roof therefore, should pass through a filter to remove leaves and other particulate matter before entering the storage tank.

<sup>4</sup> For details contact: WISY (Winkler system) OT Hitzkirchen, Oberdorfstrasse 26, D-63699, Kefendrod-Hitzkirchen Germany; fax: +60-54-912129 [Wisysag@t-online.de](mailto:Wisysag@t-online.de) (Source: John Gould and Erik Nissen-Petersen, 1999: *Rainwater Catchment Systems for Domestic Supply - Design, Construction and Implementation*, Intermediate Technology Group)

Additionally, biological contamination can be removed by disinfecting the water. Many simple methods of disinfections are available which can be done at the domestic level. Specifications for drinking water are given by IS: 10500 and World Health Organisation (WHO).

## Disinfecting Water at Household Level

### Boiling

Boiling is a very effective method of purification and very simple to carry out. Boiling water for 10 to 20 minutes is enough to remove all biological contaminants.

### Domestic Filter Unit

#### Scope

It is a simple device for purifying and disinfecting raw water for drinking purposes.

#### Salient Features

The equipment provides a simple way of performing disinfection, sedimentation and filtration. It consists of three tanks – namely a raw water tank, a filter and a clean water reservoir. The unit is operated by adding half a teaspoonful of calcium hypochlorite to about 100 l of raw water in the tank, it is stirred gently for a few minutes (five minutes or so), then one spoonful of aluminium sulphate or two spoonfuls of potassium alum is added and stirred for five minutes until sediments start forming. At this point one spoonful of calcium carbonate is added

and the water in the tank is stirred and the flow is drained through the cock which is at the bottom. Then the tap is opened and water flows onto the swash plate in the second container until the tank is full. The outlet tap allows water to flow through a charcoal filter contained in a cylindrical vessel about 75 cm in length and 25 cm in diameter (it is filled with charcoal between two layers of fibrous material such as palm fibre). Water filtered through this is collected in a clean water reservoir. The unit can be easily fabricated in the village and would cost approximately Rs 250/- only.

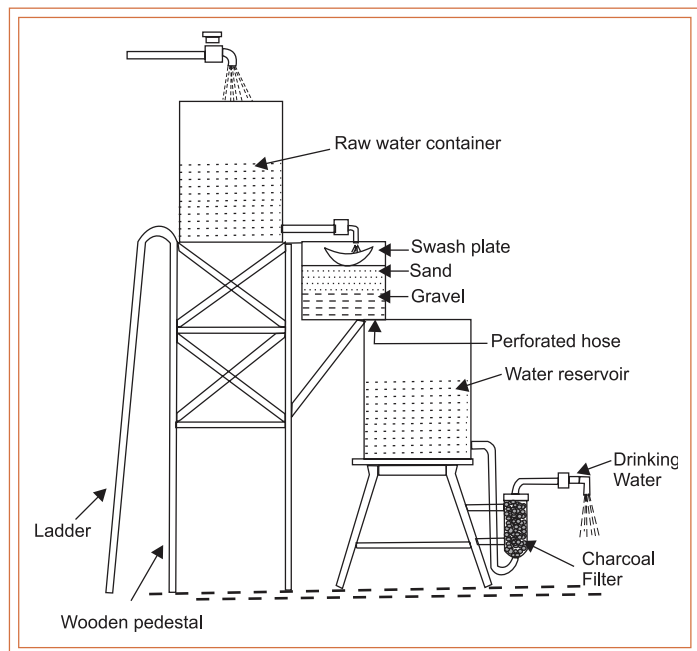

### Water Filter Candles

#### Scope

This is an inexpensive way of getting potable water in the house. The filter candle can be fitted in any type of container and can remove all suspended impurities including harmful bacteria.

#### Salient Features

The water filter candles are manufactured from non plastic materials like quartz and felspar, which are ground to the required fineness in a ball mill and mixed with china clay, plastic clay and some organic combustible materials in required proportions. A casting slop is prepared by adding the required quantity of

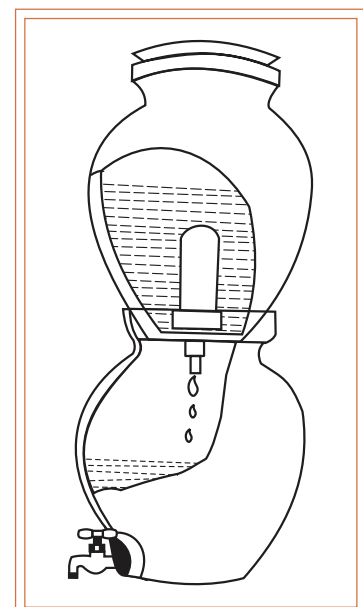

electrolytes. Candles are made by the usual casting process with plaster of paris moulds. These are finished and baked at a suitable temperature. Candles are then given a special chemical treatment so that they can give bacteria free water. The life of a candle is generally 2 - 3 years and can be installed in any domestic container.

#### Precautions in Use

The candle should be handled carefully as it is easily breakable. The surface should be cleared of the mud coating, with the help of a knife or blade periodically.

### Traditional Water Purifying Seeds

#### Scope

Good potable water can be had by using some purifying seeds.

#### Salient Features

Many local seeds are used as natural coagulants for treating muddy water, e.g. Kataka Seeds (*Strychanos potatorum*). A dose of 1.5 mg of seed extract is used per litre of water (seed extract is prepared from a thick paste of crushed seeds with clean water). The water is stirred for 3 - 5 minutes after putting the seed extract, and it is then treated with 10 - 15 mg/l of alum. This treatment reduces the turbidity to safe limits.

Similarly, drumstick (*Morenga olifera*) seeds are crushed and the powder is mixed with a small quantity of purified water in a glass and stirred vigorously for 5 minutes. The suspension is used to treat turbid water. Generally 30 seeds are required to treat 40 l of raw water.

Seeds of *bhela* (*Semacarnus anacardium*) are rubbed on stone and made into a thick paste; this can be added to treat turbid water. Sometimes coagulants like plant ashes, earth from termite hills, paddy husk or crushed seed of *elaichi* (*eletaria cardamum*) are dusted on the water surface to treat turbidity. Wiry roots of the rhizome from *ramaccham* (*Vetiveria Zizanoides*) are laid in a pitcher with small holes in the bottom and the pitcher is used as a filter. Some aquatic plants like *kolattamara* may be introduced in the ponds or wells. These plants check the pollution created by animal wastes.

### Chemical Disinfection

#### Chlorination

Chlorination is done with stabilised bleaching powder (calcium hypochlorite –  $\text{CaOCl}_2$ ) which is a mixture of chlorine and lime. Chlorination can kill all types of bacteria and make water safe for drinking purposes. About 1 gm (approximately 1/4 tea spoon) of bleaching powder is sufficient to treat 200 litres of water.

#### Chlorine Tablets

Chlorine tablets are easily available commercially. One tablet of 0.5g is enough to disinfect 20 litres (a bucketful) of water. Ultraviolet light (UV) water disinfection, a physical process, kills most microbiological organisms that

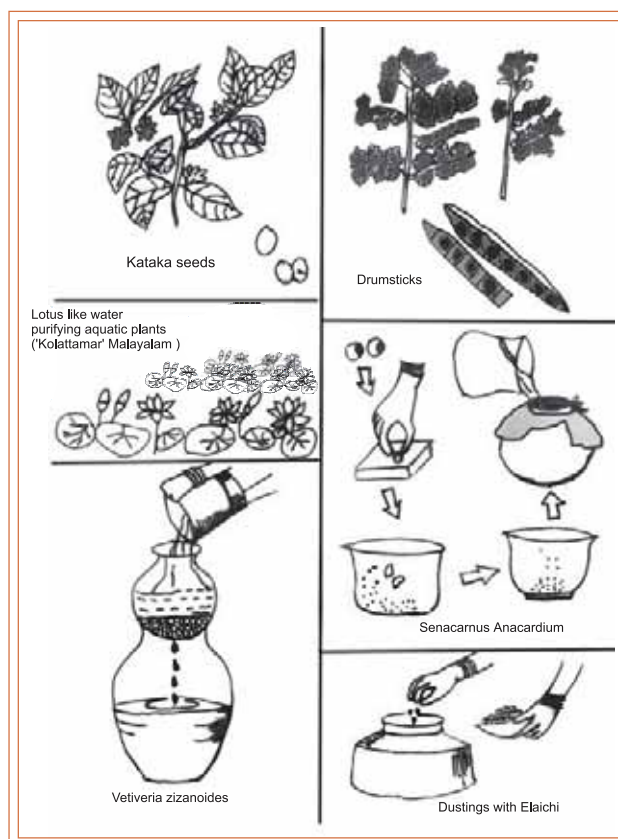

pass through it. Since particulates offer a hiding place for bacteria and microorganisms, pre-filtering is necessary for UV systems.

Ozone readily kills microorganisms and oxidizes organic matter in the water into carbon dioxide and water. Any remaining ozone reverts back to dissolved oxygen ( $O_2$ ) in the water.

### Tasks Needing Frequent Attention of Householders

- ❖ Roof surfaces and gutters to be kept free of bird droppings. Gutters and inflow filters must be regularly cleared of leaves and other rubbish.
- ❖ The mosquito net on the overflow pipe should be checked regularly, and replaced if necessary.
- ❖ Unless there is some automatic means of diverting the first flush of water in a storm away from the tank, the inflow pipe should be disconnected from the tank during dry periods. Then, 15-20 minutes after rain begins, it can be moved back into position so that water flows into the tank.
- ❖ The water level in the tank may be measured once in a week using a graduated stick (which should be kept in a clean place and not used for any other purpose). During dry periods, the drop in water level should correspond approximately with consumption. If the tank is leaking, and wet spots on its walls should be carefully looked for.

### Annual or Infrequent Tasks for Which Technical Assistance May be Required

- ❖ At the end of the dry season, when the tank is empty, any leaks that have been noticed should be repaired. Where there are wet spots on the walls, a cement/water mixture should be applied inside and finished off with a layer of plaster. Even if there is evidence of leakage but no wet spots have been discovered on the walls, the floor should be given the same treatment.
- ❖ The roof surface, gutters, supporting brackets and inflow pipes need to be checked and repaired if necessary.
- ❖ If a sand filter is incorporated, the filter should be washed with clear water or renewed. Other types of strainer, filter or screen must be checked and repaired as necessary.
- ❖ The mosquito net on the overflow pipe should be checked and if necessary replaced.
- ❖ Periodic removal of deposits from the bottom of the tank is necessary. Depending on local conditions, this may be desirable annually or only once in 3-5 years.
- ❖ After the repairs have been carried out inside a tank, the interior should be scrubbed down with solution of one of the following: 3 parts vinegar to one litre water, or 1 kg baking powder to 9 litre of water, or  $\frac{1}{4}$  cup (75 ml) of chlorine bleach to 45 litre of water. After scrubbing, the tank should be left for 36 hours and finally washed down with clean water.



## Rainwater Harvesting Around the World – Case Studies & Success Stories

The fast rate of urbanization followed by rise in demand for water has accelerated the pace of implementation of rainwater harvesting projects through various methods, depending on the local requirement. The success stories bring to the fore the tales of truth whether it pertains to developed countries like Japan, Germany, Singapore, the Philippines, the USA or developing countries of Asia and the Pacific, Africa, Latin America, the Caribbean islands and others. The stories of water harvesting serve as examples for the people facing and living in water scarce areas or flood prone places, places encroached by water salinity or affected with the problem of arsenic or the areas needing recharge of aquifers. The case studies suggest adoption of a pragmatic approach towards methodology and techniques whether it is rooftop harvesting, water runoffs at the airports, commercial buildings, industrial areas or non-polluted plains. The future strategy could be based on the lessons learnt from these experiences.

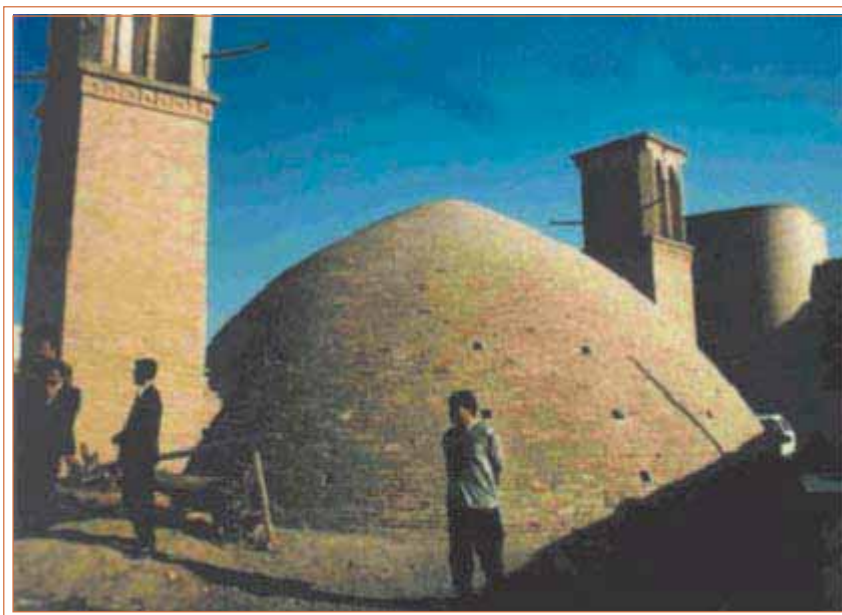

The 'Abanbar', traditional cistern in Iran (Gnadlinger) as part of a traditional rainwater catchment system for the community.

## ASIA

## South Asia

## Bangladesh

In Bangladesh, rainwater collection is seen as a viable alternative for providing safe drinking water in arsenic affected areas. Since 1997, about 1000 rainwater harvesting systems have been installed in the country, primarily in rural areas, by the NGO Forum for Drinking Water Supply & Sanitation. This Forum is the national networking and service delivery agency for NGOs, community-based organisations and the private sector concerned with the implementation of water and sanitation programmes in unserved and underserved rural and urban communities. Its primary objective is to improve access to safe, sustainable, affordable water and sanitation services and facilities in Bangladesh.

The rainwater harvesting tanks in Bangladesh vary in capacity from 500 litres to 3,200 litres, costing from Tk. 3000-Tk.8000 (US\$ 50 to US\$ 150). The composition and structure of the tanks also vary, and include ferrocement tanks (see picture), brick tanks, RCC ring tanks, and sub-surface tanks. The rainwater that is harvested is used for drinking and cooking and its acceptance as a safe, easy-to-use source of water is increasing amongst local users. Water quality testing has shown that water can be preserved for four to five months without bacterial contamination. The NGO Forum has also undertaken some recent initiatives in urban areas to promote rainwater harvesting as an alternative source of water for all household purposes.



Bangladesh: Pottery storage (MOTKA) for rainwater; ferrocement tank storage

## India

## Rainwater Harvesting in Bangalore

*Integrating Rainwater Harvesting Systems in Neighborhood Design*

A residential colony in Bangalore of about 4 square kilometres has managed to put in place a decentralized water management system incorporating rainwater harvesting more by serendipity than by design. Two small tanks Narasipura 1 and Narasipura 2 collect rainwater and act as percolation tanks to recharge the aquifer. About 15 bore-wells then supply water to the colony of about 2000 houses. Sewage discharged from each house is collected and treated both physically and biologically through an artificial wetland system and led into Narasipura 2. The loop of water supply and sewage treatment is completed within a small geographical area, in an ecologically and economically appropriate manner.



First-rain separator - Segregator:  
Simple and easy to maintain



Drums - Filters and intermediate storage segregator

Source: A conceptual Frame for RWH in Bangalore (2000): A study undertaken by Centre for Symbiosis of Technology, Environment and Management (STEM) commissioned by GOK.

**Box 4.1**

**Designing Rainwater Harvesting Systems in Urban Environment for Direct Use**

The Industrial unit of ESCORTS-MAHLE-GOETZE is located in Yelahanka a northern satellite town of Bangalore. The industrial unit has a site area of 20 hectares.

Breakup of the area:

- ❖ Rooftop area: 29,961 sq.m
- ❖ Paved area: 43,095.66 sq.m
- ❖ Unpaved area: 129,286.98 sq.m

The total rainwater harvesting potential of the site is 185 million litres.

A pilot project was set up in May 2000 covering about 1280 sq.m of roof area for the administrative block and the canteen building. With a storage capacity of 4200 litres, the unit collects about 1.05 million litres per year. The system is expected to pay for itself in five years.

The pilot system has received widespread publicity and is seen as a pioneering model for water harvesting by an industrial unit in Bangalore. The rooftop water harvesting is now being scaled up to cover 3000 sq.m. of roof area.

Rainwater incident (harvesting potential) on the site was calculated to be 185 million litres of which it was estimated that 62 million litres could be harvested in a series of sumps and finally 3 ponds at the lowest contour of the site. A rooftop harvesting system for 2500 square metres of roof area has been put in place, which collects 2.40 million litres every year. Finally, designing has been done to harvest the entire 62 million litres in the lined ponds. A payback period of about 3 years is expected for the rainwater harvesting system proving financial viability of the project.

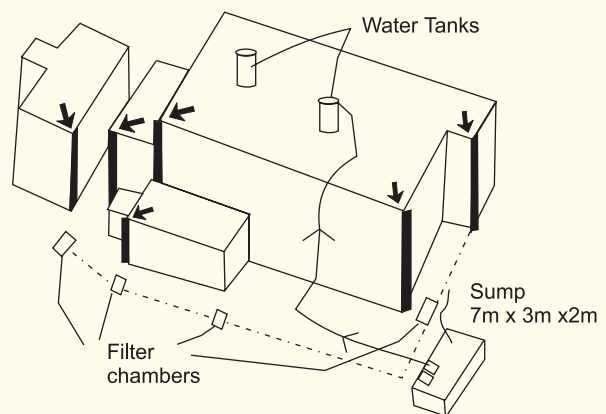

### Rainwater Harvesting Initiatives in Indore, Madhya Pradesh, Central India

The commercial capital of the state of Madhya Pradesh has been facing acute shortage of drinking water. This is reflected in the wide gap of 152 MLD in the demand and supply of drinking water in the city. The ever-growing water demand made the administration think about rainwater harvesting.

**Practices in rainwater harvesting:** Indore city is located on the basaltic lava flows of the Deccan Trap. Weathered/vesicular/fractured and jointed basalt form aquifers in the area. The average annual rainfall in this area is 930 mm and one-hour peak rainfall is 35 mm. Indore has got large areas of roofs and paved areas and hence a large quantum of runoff is produced from these areas during the rainy season. This runoff goes waste as overland flow and also creates problems of flooding in low-lying streets. In such a scenario, rooftop water harvesting provides the desired solution. Essentially, aquifer recharging practices are being used. In order to motivate the public, Indore Municipal Corporation (IMC) has announced a rebate of 6 per cent on property tax for those who have implemented the rainwater harvesting work in their house/bungalow/building. To operate these activities, three committees – technical, education and execution – were formed by the IMC in which various experts were involved. The various methods of ground water recharge used are open wells, soak pit, recharge shaft/trench with and without injection well, lateral recharge shaft, injection wells and in big schemes, suitable combination of different methods of RWH are employed.

#### Techniques of water recharge used in Indore:

The technique essentially comprises diverting rainwater through trench or swale into silt trap tank. Water from the silt trap tank is allowed to pass through a sand filter (sand, medium and big size pebbles). A cement pipe of 300 mm diameter, fitted with wire net (10 mm mesh) has been fitted on the wall of wells through which rainwater gets poured into the well.

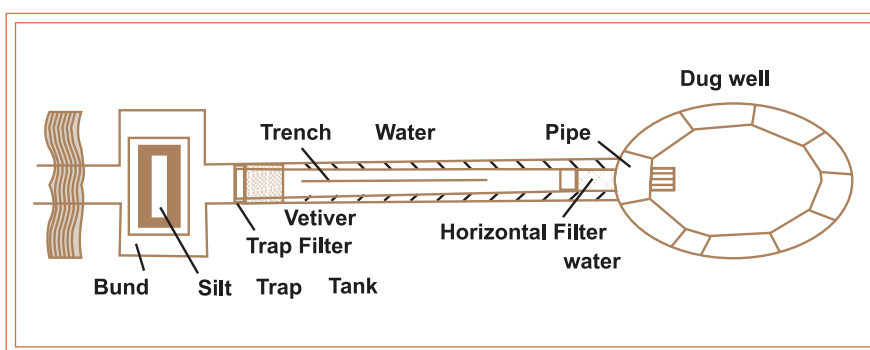

Water recharge through dug well indore method

**Permeable box:** Permeable boxes of 1 cubic metre, filled with big size pebbles and brick pieces and lower portion with sand are provided at the top of the pile.

**Swales and Pile:** Swales are shallow, saucer like beds locally known as *khantis*. Making of swales does not in any way affect usual activities on the playground or on the road. Pile is a commonly used technique for RWH in gardens, playgrounds and public places. A 2-3 m deep hole is manually dug. The bottom one-third is filled with large (40-50 mm) pebbles, the middle portion with medium size (20 to 30 mm) pebbles and the upper one-third portion with sand (2-3 mm).

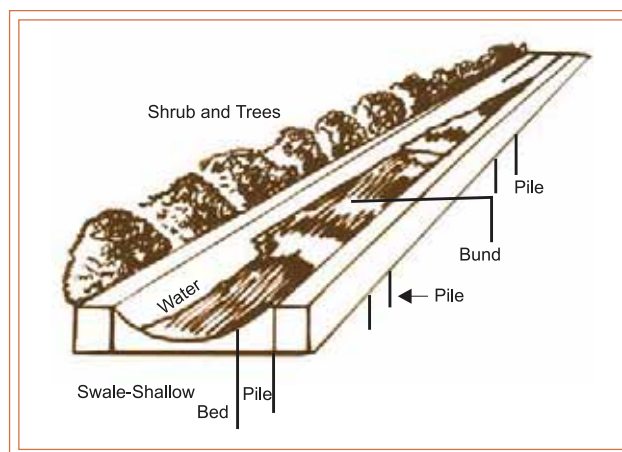

Swales and Pile

### Panchsheel: The Water-rich Colony of South Delhi

When almost all the colonies and associations crib about water supply in summer, Panchsheel Cooperative Group Housing Society has set an example by funding a rainwater harvesting project and harvesting each drop of rain.

#### *Panchsheel Success Story–Some Highlights*

- ❖ Total rooftop and surface area: 3,57,150 sq.m.
- ❖ Total volume of rainwater harvested: 1,74,575 cubic metre (m<sup>3</sup>), or 174,575,000 litres (2002)
- ❖ This represents 80 per cent of the total water harvesting potential.
- ❖ Before implementing rainwater harvesting, the water level was around 28.6 m below ground level. The water level was 26.1 m in September 2002 and 27.6 m in May 2003. The water level in July 2003 after the monsoon was 27.3 m, representing a total rise of 0.7 m, or 2.29 feet.

The water-harvesting project covering all the plots in the colony involved Rs. 0.8 million (US \$20,000) investment and the money was invested by the Society rather than asking for individual financial help. After registering the success for two consecutive years, now the Society is planning to spread awareness to 'use less water' in the locality, as the area is largely dependent on tube wells.

After the success of rainwater harvesting, the Society has made a detailed plan of the wastewater treatment project in the colony. The plan has been prepared in association with the Centre for Scientific and Industrial Research (CSIR) which will provide the bacteria to purify the water. As per the plan, initially the pilot project will have the capacity to treat about 20,000 litres per day and the project will involve not more than Rs. 0.1 million. The treated water will be used for irrigation purposes in the colony and major portion of it will also be used in the Society office and Panchsheel Club, including use in the flush. But the Society is planning to take it extensively after the initial success, which will include supplying the treated water to toilets of flats in the coming years. The residents will have to spend to get the water from the main pipe to their toilets. This project can set another example for other associations, as according to experts, the use of specially developed bacteria to purify the water will bring down the cost of wastewater treatment.

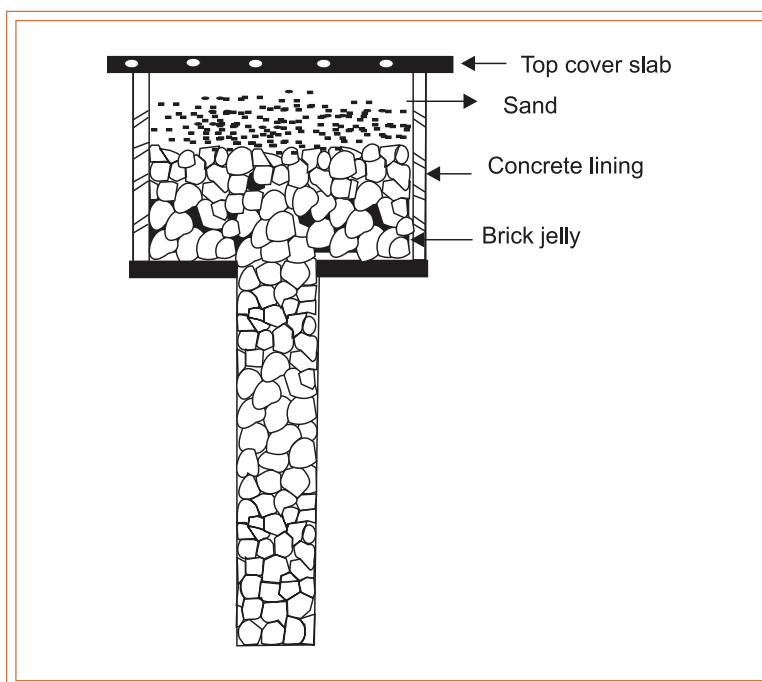

Ensuring percolation: Cross-section of percolation pit

**Lesson:** Neighbourhood associations having money in banks should take up such projects rather than wait for help from the government.



**Manchsheel Cooperative Group Housing Society, New Delhi**

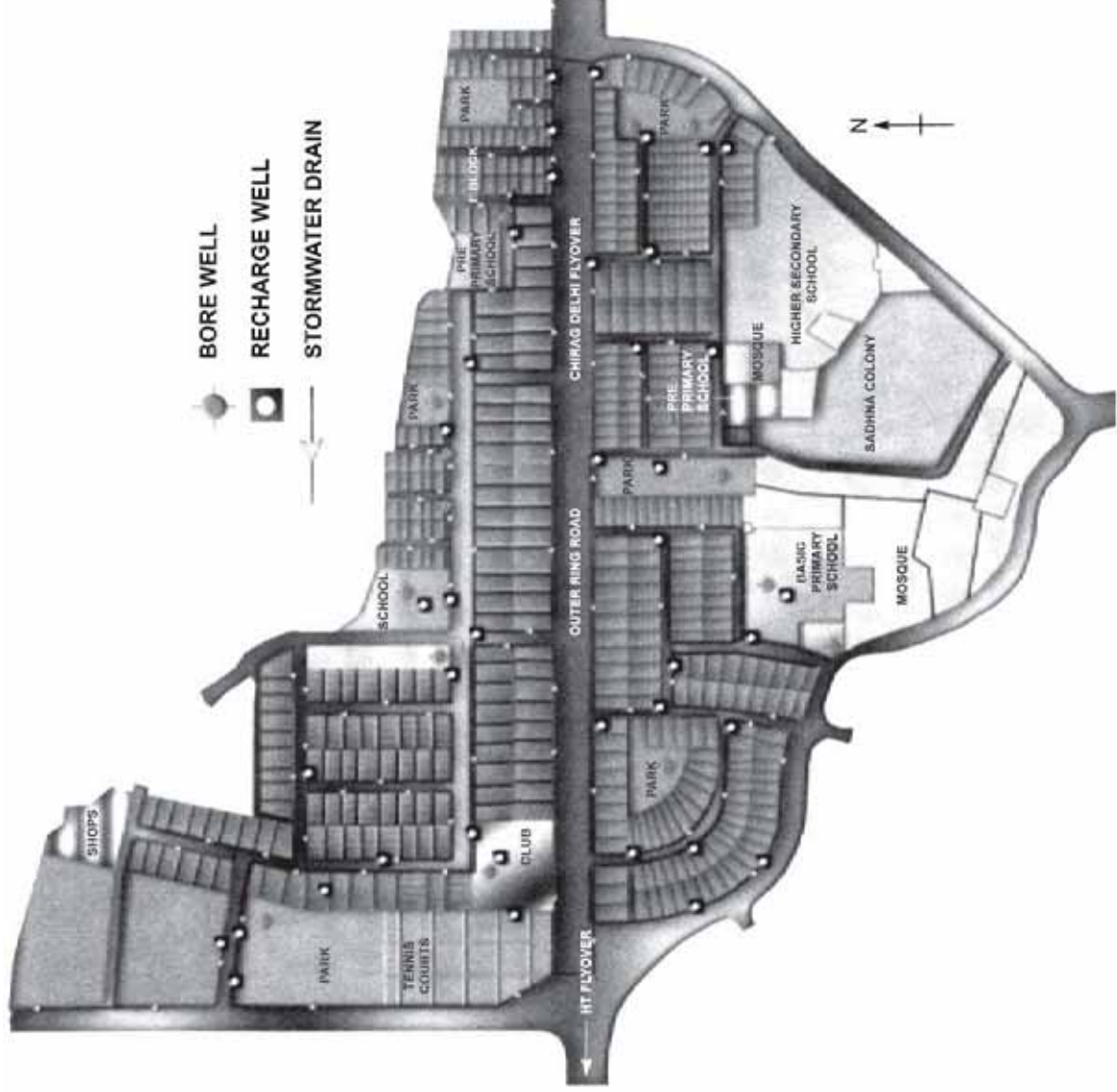

Rainwater harvesting site plan

## Sri Lanka

Sri Lanka receives abundant rainfall with mean annual totals ranging from 900mm to 6000mm, with an overall national mean of around 1900mm per year. Due to the availability of alternative water sources in the past, there is no long tradition of roof water harvesting for domestic supply. Nevertheless, in many hilly areas lacking access to reliable wells or gravity fed piped supplies, water collection often involves a long trek to distant sources with a long uphill return walk carrying a full container. Following a study conducted in 1995, the Community Water Supply and Sanitation Project (CWSSP) first undertook a demonstration and pilot project involving the construction of about one hundred 5m<sup>3</sup> roof tanks for household water supply. Two designs were developed: a sub-surface brick tank and a surface ferrocement tank costing about \$100 and \$125, respectively. A household with an average roof size of 60 sq.m. in the project area could expect a rainwater supply equivalent to between 150-200 litres/day or even higher during the wettest part of the year.

By the end of 1997 over 5000 grant applications for tank construction had been approved by the CWSSP in Badulla and Matara Districts and around 2800 tanks had already been constructed. The Lanka Rainwater Harvesting Forum was established in 1996 to promote the application of rainwater for domestic purposes throughout the country and to develop technology and establish guidelines for good rainwater harvesting practices.

### Various Tank Designs Developed in Sri Lanka

#### *The Pumpkin Tank*

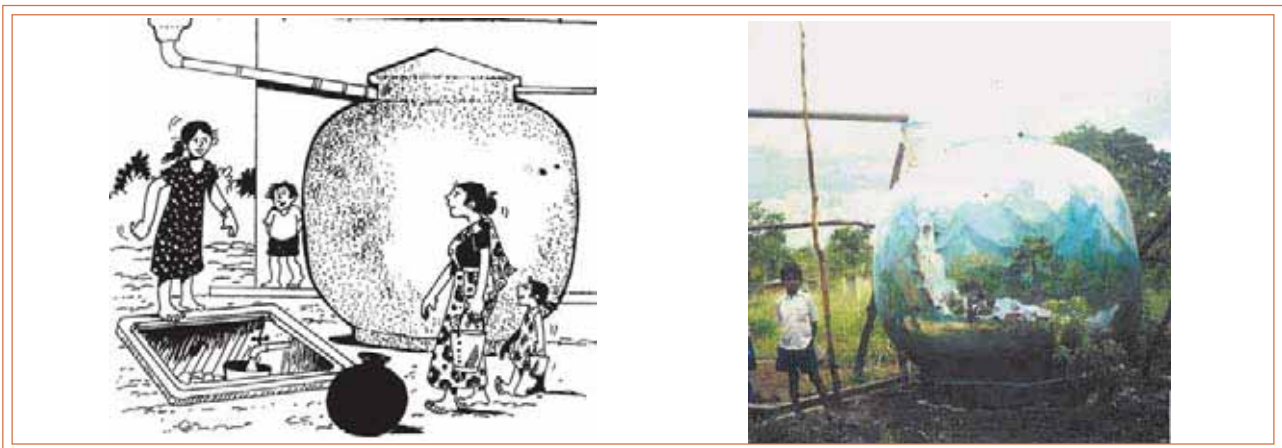

The town of Badulla is located in a hilly area of Sri Lanka. Climate: Tropical, Bimodal; Ground water sources are few and tend to be at the bottom of the hills. To reduce the burden of carrying water the local authority provided 5,000 litre ferrocement tanks, at a cost of about \$150 which are used for most household water supplies. The tanks are now being adopted nationwide for use in areas where access to other protected water sources is difficult.



*Brick built storage tank*

This is an example of local initiative in the design and manufacture in domestic rainwater harvesting structures. The tank in question was constructed in the village of Ahapokuna, near Kandy, in the highland area of Sri Lanka. The tank was built 10 years ago by a local mason for the Rajasomari family and has since been adopted by others so that there are now several of these tanks in that area

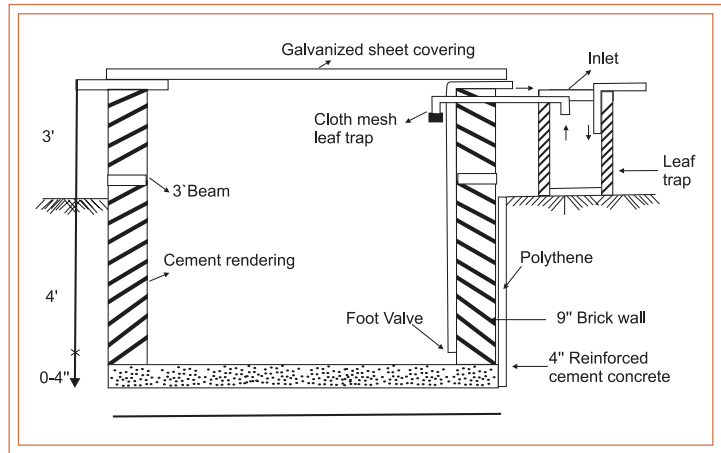

Catchment – 90 sq.m.

Storage – 3 cu.m.

Storage cost – GB pounds 80 (estimated)

Material – Brick with cement render

Lessons: Square construction with bricks is good and simple for local masons

*Partially Below Ground Brick Built Tank, Sri Lanka*

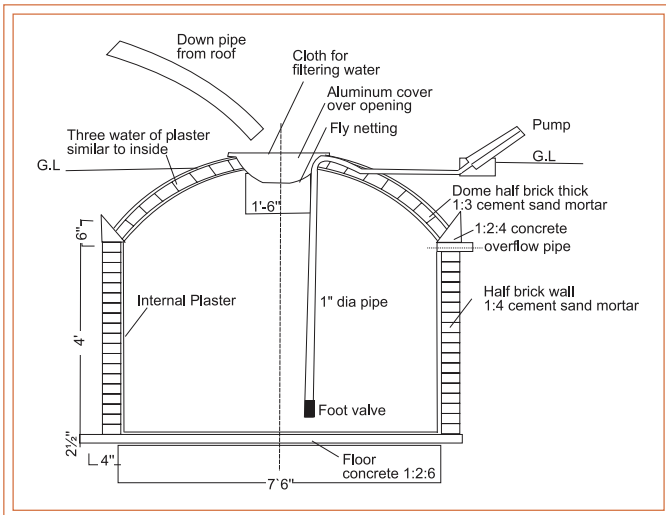

This tank was built by Mr. G. Victor Goonetilleke in the hill town of Kandy. Mr. Goonetilleke decided to build his own rainwater harvesting tank after experiencing difficulty in sinking a well to sufficient depth to have a reliable perennial source of ground water at the site of his newly built home.

Storage – 10 cu.m

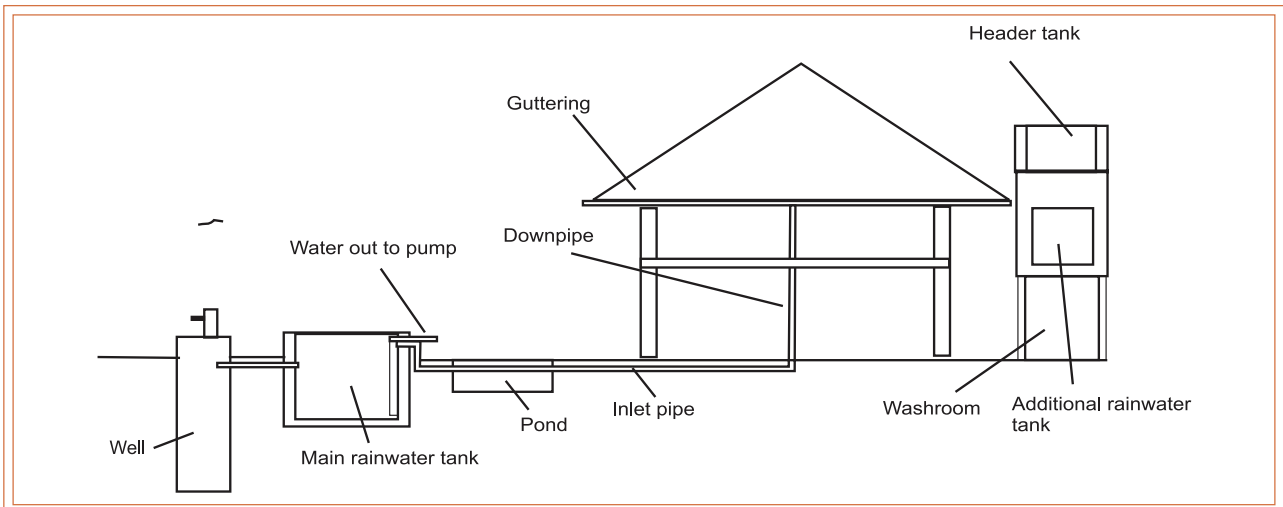

Sketch showing the whole scheme including the water tower

## South-East Asia

### Japan

#### Promotion of Rainwater Collection in Tokyo

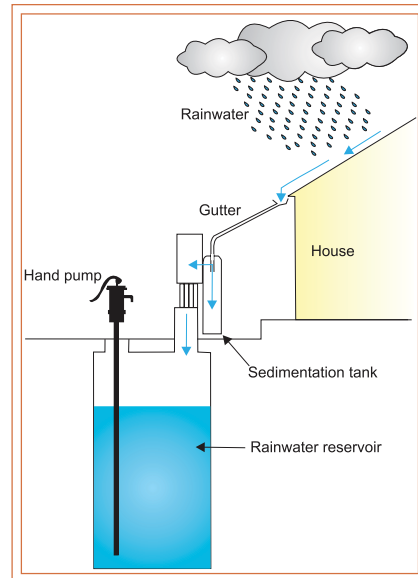

### Singapore

The Republic of Singapore has a land area of 61,000 hectares. Water availability is poor. In spite of 50 per cent of land area being used as a water catchment area, almost 40-50 per cent of water requirements are imported. After considerable research and development, schemes for abstraction of ground water in Singapore include utilisation of roofs of high rise buildings, use of run-off from airports for non-potable uses, integrated systems using combined run-off from industrial complexes, aquaculture farms and educational institutions.

#### Gutters and Conveyance Systems in Use in Singapore Households

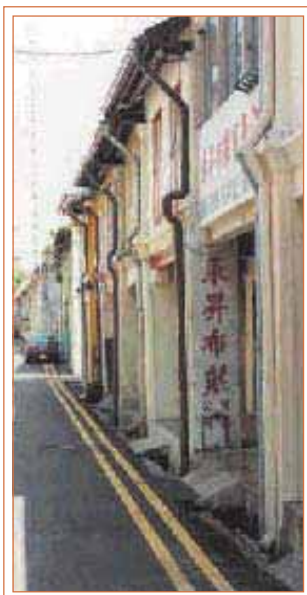

A recent study of an urban residential area of about 742 ha used a model to determine the optimal storage volume of the rooftop cisterns, taking into consideration non-potable water demand and actual rainfall at 15-minute intervals. This study demonstrated an effective saving of 4% of the water used, the volume of which did not have to be pumped from the ground floor. As a result of savings in terms of water, energy costs, and deferred capital, the cost of collected roof water was calculated to be S\$0.96 against the previous cost of S\$1.17 per cubic meter. The catchment areas under utilisation are relatively clean and as a result the raw water is of good quality. Singapore has earmarked specific locations where pollution-contributing activities are prohibited. The growing need of water led to establishment of Lower Seletar-Bedak Water Scheme in 1986. Control of water pollution and relevant technologies were the main

priorities in the said scheme. Control of water pollution required great inter-departmental coordination which included government and quasi-government groups.





Besides inter-departmental planning for controlling water pollution, there are other important factors to be considered in the overall planning of such systems which include: hydrological simulation, water quality, trapping urban run-off, sediment removal, etc. It has been established in Singapore that the utilisation of urban catchments is a reality that can be highly efficient if the system is well planned and is maintained and monitored. Additional research and development will help to optimize the reliable yield from such catchments and make the multiple uses of such catchments a truly working proposition.

A marginally larger rainwater harvesting and utilisation system exists in Changi Airport. Rainfall from the runways and the surrounding green areas is diverted to two impounding reservoirs. One of the reservoirs is designed to balance the flows during the coincident high runoffs and incoming tides, and the other reservoir is used to collect the runoff. The water is used primarily for non-potable functions such as fire-fighting drills and toilet flushing. Such collected and treated water accounts for 28 to 33% of the total water used, resulting in savings of approximately S\$ 390,000 per annum.

The experience of Singapore shows that the concept of utilizing small catchments has to be accepted. The system of rainwater harvesting can be adopted in all the airports. The airports can provide both larger surface run-off and roof water. For utilizing urban catchments, there is a need for proper coordination among various departments. This is very important to monitor qualitative and quantitative characteristics of the raw water.

### Thailand

#### Thai Jar Programme

Thai Jar Programme of the Thai Government remains an unparalleled rain harvesting movement of the world. In a couple of years, starting from 1985, the country constructed six million jars to harvest the rain for drinking purpose. This way, about 36 million people had a minimum amount of good drinking water at their households. Probably no other developing country has been successful in providing clean and safe drinking water to a majority of its population this way.

Based on the survey of 513 households done in 1985, the following conclusions were made:

- ❖ Storing rainwater is the best solution for the provision of drinking water
- ❖ Each person needs 5 litres of water per day for drinking
- ❖ Average family size is 6 persons per family
- ❖ In a year, there are 150 days during which water from jar has to be used
- ❖ Jars of 2,000 litres capacity are adequate for these families

The survey also revealed that roof areas of the houses varied from 50 to 150 square metres with an average size of 80 square metres. For a roof of 80 sq.metres, 25 mm rainfall is sufficient to collect 2 cubic metre (2,000 litres) of water. Thailand has an average annual rainfall of 1000 mm. As such, even in relatively dry years, the amount of rainfall during any one month of the rainy season is sufficient to supply drinking water through the dry season. It is estimated that there are 6,00,000 households in rural Thailand. If 80 per cent of this number has to be provided with one jar, required total of jars is 4,80,000. A committee was set up with the target of providing 5 million jars. It was decided that the target should be met by 1987 when His Majesty, the King of Thailand would celebrate his 60<sup>th</sup> birthday.





A national plan was prepared for drinking and domestic water. Though this plan was of five-year duration, 80 per cent target was fixed for the first two years. Committees were set up for technical development, training, public relations and promotion, fund acquisition and monitoring. A construction manual was published. Tempos carrying the model of roof-water harvesting with a jar crisscrossed the country with stopovers at villages for small meetings. Government would supply cement and inputs plus training. Labour and cost of all the materials had to be borne by the consumers.

Masons were trained at district level. Strict specific instructions were given on the materials and method of construction of the jars. The monitoring and evaluation sub-committee kept a close watch on the progress of the programme. From April to October all the regions of Thailand get good rains. November to March (150 days) is the dry period. In the rainy season, they can go on consuming water from the jar liberally since there is a guarantee that it will get refilled soon. In October, they have to ensure that the jar remains full for use during the next five months. Southern zone is lucky to get good rains in November and December. This means, they will have a dry spell of only about 90 days.

Material cost for one jar of two cubic metre amounts in between 15 to 20 US dollars depending on the location where it is constructed. Each jar needs two man-days for making. To lend a helping hand to the villagers to help themselves, Thai Government set up a revolving fund. It works like this: Government will provide 10,000 baht as initial fund. Each household that participates in the project has to pay 400 bahts to the fund to cover the cost of materials. Training of villagers in jar construction technique was funded by Thai Government and conducted by the provincial universities. Each village sent two trainees to learn the construction method, operation and maintenance techniques. After their training, they had to teach this to others in the village. The idea was to have users involved in drinking water supply development so that they can acquire the skills and confidence to operate in future.

Apart from the Government contribution, considerable resources were pooled from non-government and private sector. Three private cement companies donated 1,503 tons of cement. There were incentives for implementation agencies too. The province where all the households were serviced by a jar was awarded the prestigious 'golden jar'. Mahasarakham Province was first to bag this award. Subsequently, Phayakaphumpisai, Nakhon Ratchasima Buriham and Phetchaburi Provinces also followed suit. By 1986, a total of 1.3 million jars had been completed. By 1987, this figure rose to 2.9 million, providing drinking water to 46,75,000 households. Taking into account the large number of small capacity jars (about 14 million) that were made, the equivalent capacity totals to 5.7 million jars by 1987. This way, 80 percent of the households were covered.

### **Khon Kaen, Thailand**

*Climate: Tropical, Monsoon; Rainwater used as primary source*

Northeast Thailand was the scene of one of the world's largest roofwater harvesting disseminations. The technology of choice was the 1-2,000 litre "Thai jar" The project passed through several stages with reducing outside intervention, eventually becoming a commercial market producing jars in large numbers for less than \$30. This encouraged rapid penetration of rainwater jars and today most houses, rich or poor, have at least one.



## Central Asia

### Jordan

Around 850 B.C. King Mesha of Moab was victorious in war and conquered a considerable territory east of the Jordan. This is at least what he himself claimed in the famous “Moabite Stone” text. One detail in King Mesha’s self-praise is of particular interest to the theme of this paper:

*... and I made two reservoirs in the midst of [Qerkhah]. Now there was no cistern in the city, so I said to all the people, “Make you every man a cistern in his house”. ...*

While this may be one of the first texts mentioning water cisterns, the valuable device itself must have been invented considerably earlier. This refers to the age-old Jordanian habit (present in the surrounding countries as well) of cutting and maintaining at least one rainwater-collecting cistern at one’s homestead. The cisterns were often technologically sophisticated, with sedimentation basins to separate mud and sand before the water was let into the main cistern. The combined storage capacity of these cisterns must have been considerable. A reservoir in Madaba could hold about 42,750 cubic metres. Masada west of the Dead Sea was supplied with cisterns of up to 4,000 cu.m. individually and together holding some 40,000 cu.m. The largest projects were meticulously planned systems of cisterns, channels and collecting surfaces.

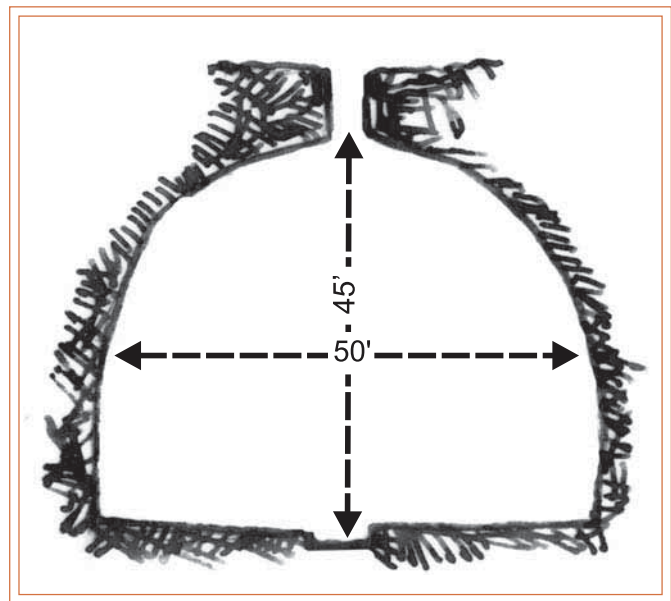

Section of cistern at Aisâwîyeh

The rainwater was generally collected from the roof and courtyard of the house, in cities as well as in the countryside. A private cistern was seen as a necessary element in the planning of a new house in Tunis in the fourteenth century. A 1921 census in Jerusalem counted 7,000 cisterns collecting runoff water. Most of them are long out of use and filled with debris and sediment. It should nevertheless be possible at least to clean out many of the ancient cisterns and bring them back into use. This would, as indicated, add considerable storage capacity to the country. It is estimated that about 92 per cent of Jordan’s annual rainfall evaporates; if one per cent of that can be collected instead it would mean “another King Talal Dam”.

As many of Jordan’s villages are now supplied with water through pipes from some distant source, households do not seem to sense any personal responsibility to fulfill part of their water needs. When a lack of water is felt it is more likely that “the minister” is implored to do something about it. One informant stated that even today in Amman it is legally required to include a cistern in any new house, but that some people fill them with piped water instead of rainwater.

### Rainwater Harvesting in China’s Gansu Province

Gansu Province lies on the loess plateau in central China and is one of the driest and poorest areas of the country with annual per capita incomes of around US\$70-80 in rural areas. Traditionally, people have depended

on rainwater as their main source of water supply, excavating 20m<sup>3</sup> clay lined underground cisterns in the loess soil for storing surface runoff. In dry years, however, these could not always provide sufficient water and people were forced to trek long distances to rivers or depend on government water trucks. In 1995 the region suffered its worst drought in 60 years. In response, the Gansu Research Institute for Water Conservancy with the support of the Provincial Government launched the 1-2-1 projects which was based on test trials, demonstrations and pilot projects carried out since 1988.



The rainwater is collected from asphalt paved highway and conveyed to underground water cellars through a concrete lined ditch



A close look at the ditch and water cellar

The 1-2-1 projects were so named because each family was provided with 1 clay tiled roof catchment area, 2 upgraded cement water cellars and plastic sheeting for concentrating rainwater runoff on 1 field. Traditional clay lined water cellars (Shuijiao) were upgraded by lining them with cement or concrete and small metal pumps attached. Proper tiled roof catchments and cemented courtyards replaced the bare earth catchments and strong plastic sheeting was placed over the rills on fields to concentrate runoff onto crops. Some households also used spare plastic sheeting to construct temporary greenhouses using wooden frames. A trench dug around these was used to collect rainwater for watering the vegetables being produced.

Using these simple, effective yet inexpensive approaches, the project assisted over 200,000 families in 1995-1996 and ensured that around 1 million people were provided not only with sufficient water but also with food and, through the production of cash crops, some limited income. For a total cost of around \$12 million, half provided by the local government and half by community donations, the recipient families acquired upgraded water supplies and supplementary irrigation. The provision of labour and locally available materials by the community ensured that the total implementation cost for the project amounted to just \$12 per capita.



A group of water cellars and the rainwater collection field lined with concrete



A group of water cellars fed with rainwater collected from concrete lined sports yard of a primary school

Contributed by: Li Yuanhong, Project Director ([gsws@public.lz.gs.cn](mailto:gsws@public.lz.gs.cn)) Gansu Research Institute for Water Conservancy, China

OTHER REGIONS

Europe

A Typical European RWH System

The figure shows a typical European RWH system. In Europe raw rainwater is used primarily for garden irrigation, toilet flushing or clothes washing. RWH systems are usually used to supplement the mains water supply. The move toward RWH in Europe has been driven by rising mains water costs and environmental awareness. The national water bye-laws of most European countries put strict controls on RWH systems to prevent contamination of mains.

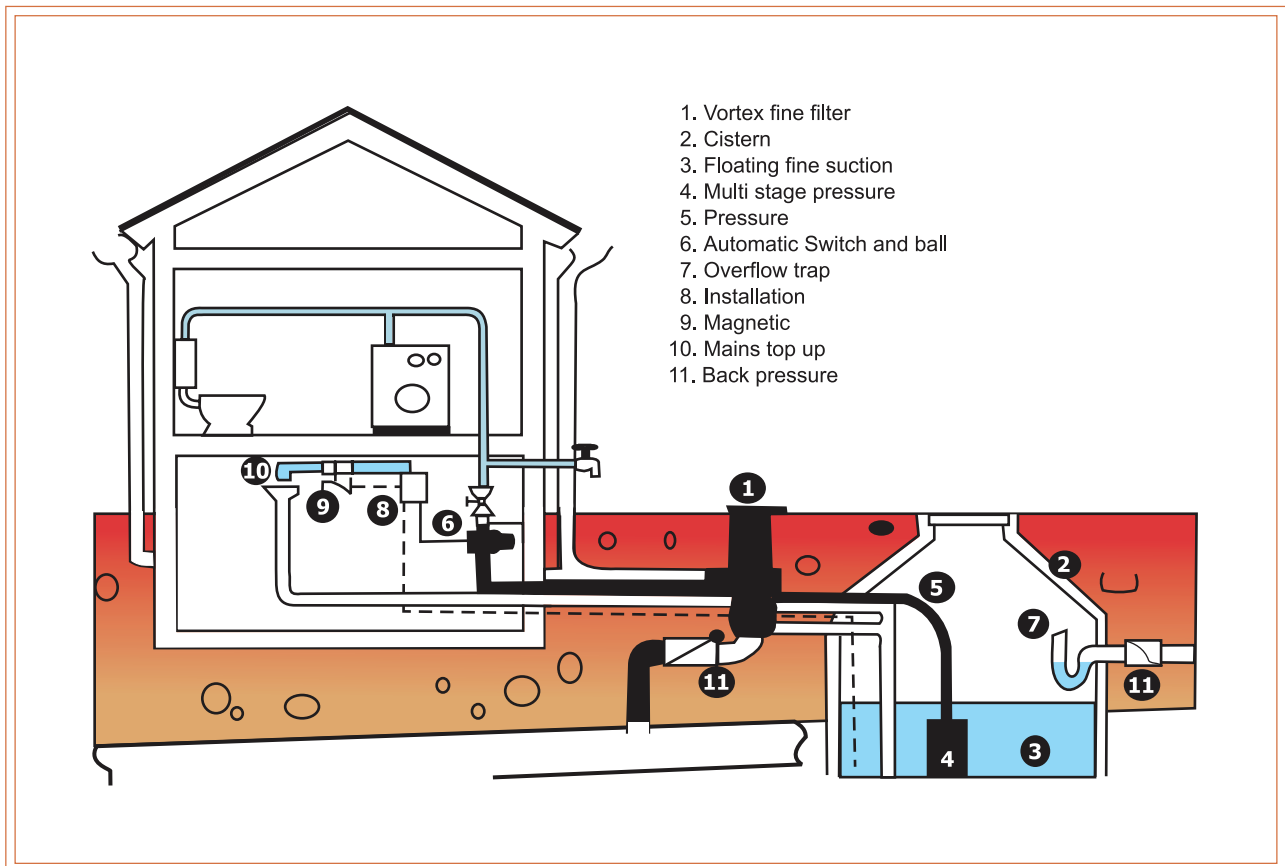

America: North, South & Central

Barbados

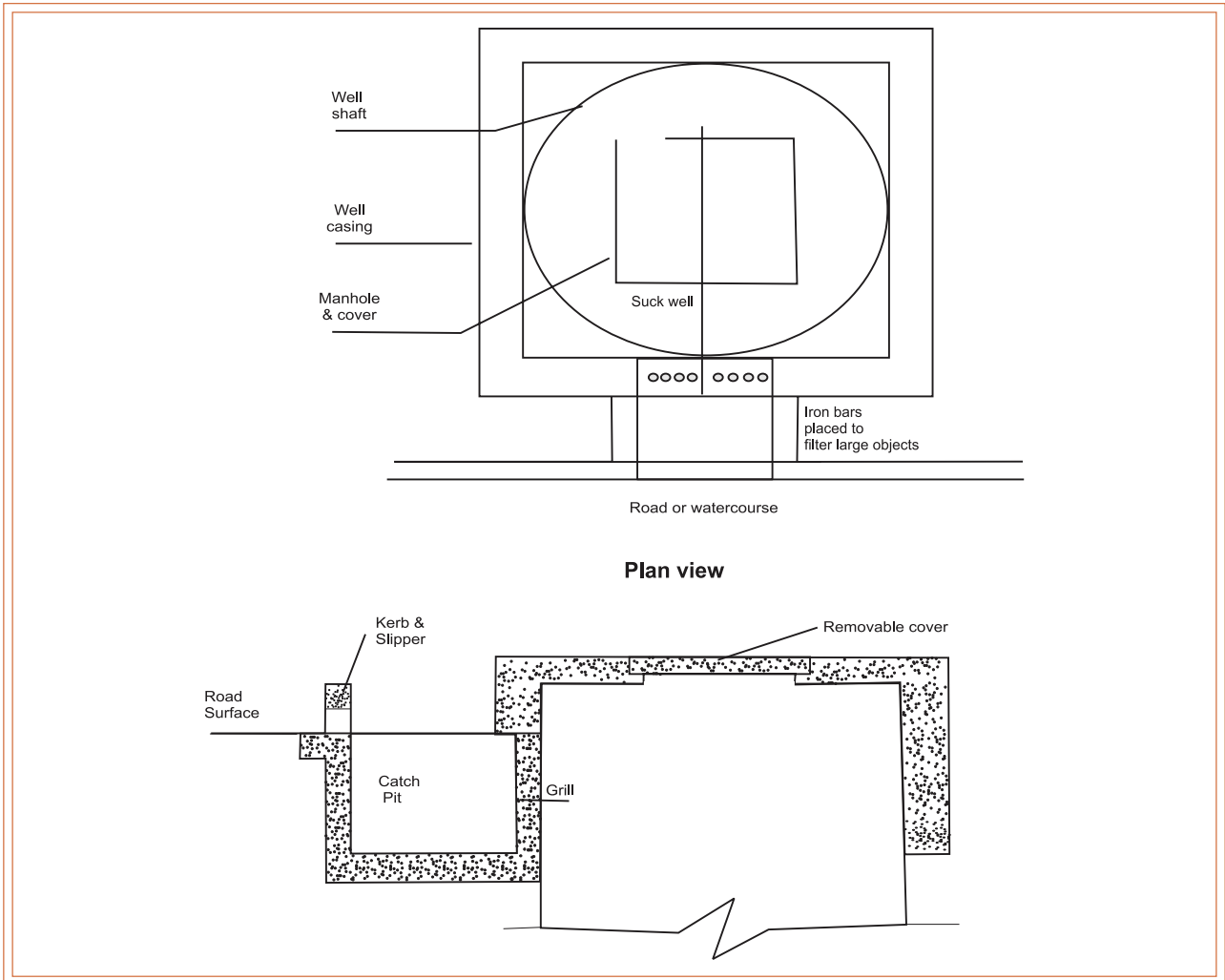

Source: Government of Barbados, Stanley Associates Eng. Ltd., and Consulting Engineers Partnership Ltd. Barbados Water Resources Study, Vol. 3: Water Resources and Geohydrology, 1978. Suckwell Construction.

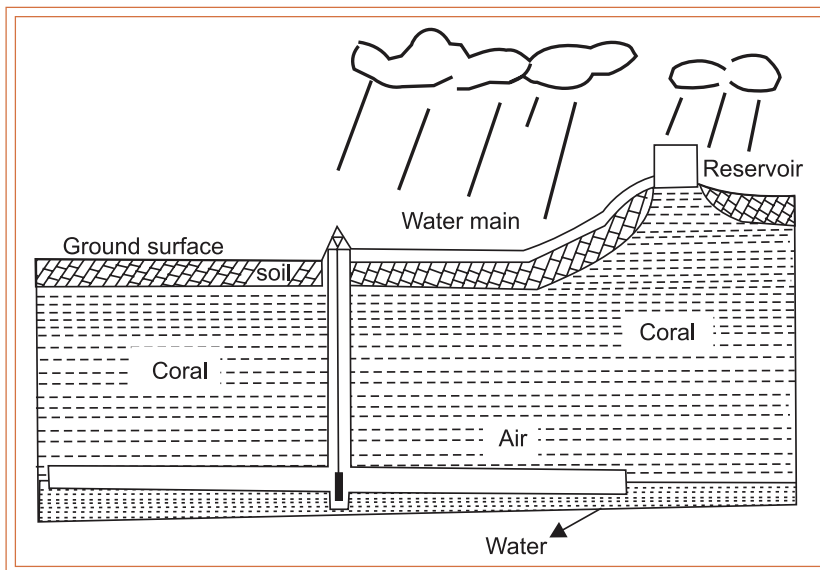

Infiltration gallery used in Barbados



## Brazil

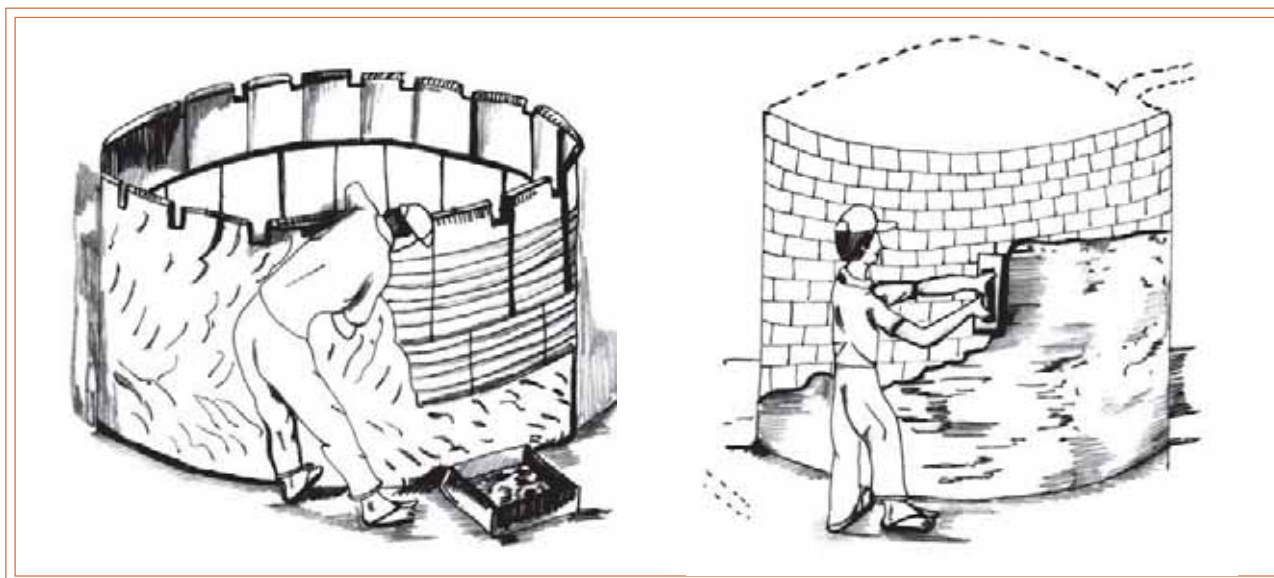

Tanks made of pre-cast concrete plates & wire mesh concrete

Over the past decade, many NGOs and grassroots organisations have focused their work on the supply of drinking water using rainwater harvesting, and the irrigation of small-scale agriculture using sub-surface impoundments. In the semi-arid tropics of the north-eastern part of Brazil, annual rainfall varies widely from 200 to 1,000 mm, with an uneven regional and seasonal rainfall pattern. People have traditionally utilised rainwater collected in hand-dug rock catchments and river bedrock catchments. To address the problem of unreliable rural drinking water supply in north-eastern Brazil, a group of NGOs combined their efforts with the government to initiate a project involving the construction of one million rainwater tanks over a five year period, with benefits to 5 million people. Most of these tanks are made of pre-cast concrete plates or wire mesh concrete.

Rainwater harvesting and utilisation is now an integrated part of educational programs for sustainable living in the semi-arid regions of Brazil. The rainwater utilisation concept is also spreading to other parts of Brazil, especially urban areas. A further example of the growing interest in rainwater harvesting and utilisation is the establishment of the Brazilian Rainwater Catchment Systems Association, which was founded in 1999 and held its 3rd Brazilian Rainwater Utilisation Symposium in the fall of 2001.

### Different Types of Rainwater Harvesting in Northeastern Brazil

Until now, among various cistern types used to resolve the drinking water problem in rural areas in Northeast Brazil, the concrete plate cistern made of cement plates (50 cm wide, 60 cm long and 3 cm thick) 14-gauge binding wire and plastered in and outside has been the most constructed cistern. As the adherence between the concrete plates sometimes is insufficient, tensions can cause cracks through which the water can leak.

For this reason, in the future the wire mesh concrete cistern (using a cast during the first construction phase) will probably be the most used and appropriate type for cistern construction in the region. This type of cistern hardly leaks and if it does, it can be easily fixed. It is also useful for small and big cistern building programs.

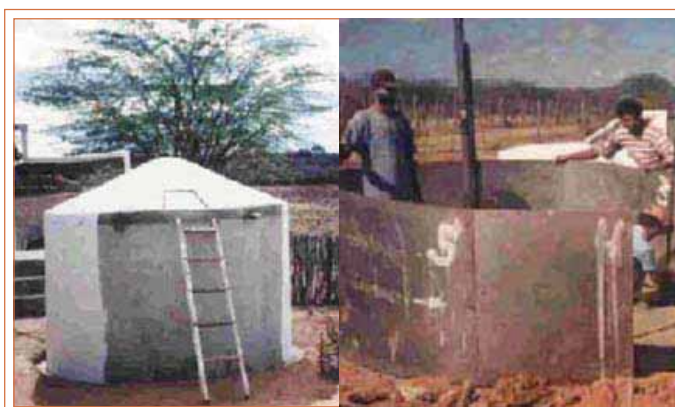

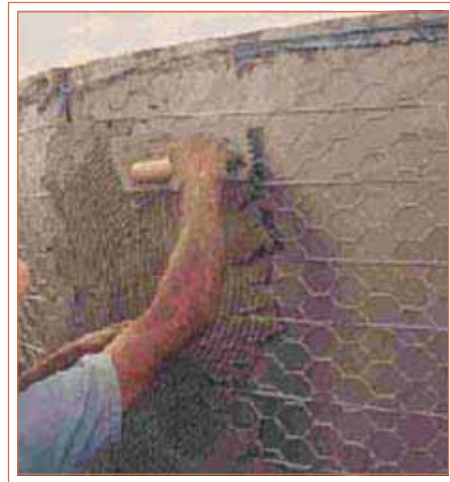
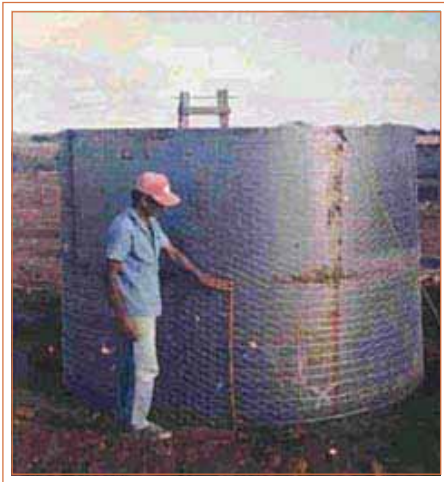

Steel sheet form wrapped by wire mesh and galvanized wire / application of first layer of mortar on top of wire  
(ref: Instituto Regional da Pequena Agropecuária Apropriada – IRPAA)

### Wire Mesh Concrete Cistern / Screwing of Steel Sheet Form

*Petrolina, Brazil*

Climate: Semi Arid; Rainwater used as main source. Petrolina is in the semi arid belt of Northeastern Brazil. Rainfall is low and varies greatly year-on-year. A solution to the water-scarcity problem is the use of large (10,000-20,000 litre) tanks that can store enough water to last a frugal household until the next rains. The tanks are usually provided by NGOs as the large structures necessary in this very arid area cost over \$200 and are unaffordable for the local population.

The so-called life saving / supplemental irrigation impoundments collect rainwater runoff from a big natural ground catchment area. Downstream of the impoundment people plant annual crops like beans, corn or sorghum. If there is a drought spell during the rainy season, people can water the fields with the help of gravitation from the impoundment. If they don't need the water, they can plant again in the dry season and use the water for irrigation of a second crop.

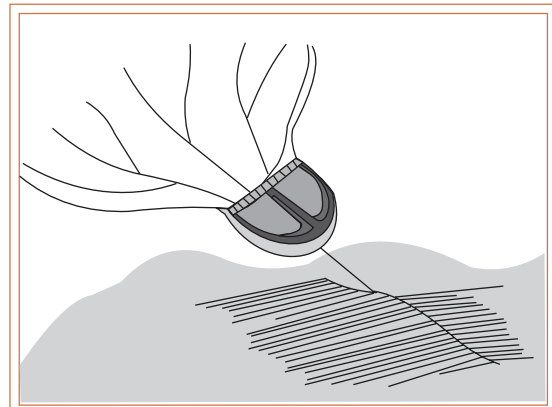

## Rainwater Survey in Squatter Areas of Tegucigalpa, Honduras

In a two-month survey of Israel Norte and Villa Nueva squatter settlements in Tegucigalpa in 1990 by local water NGO Agua para el Pueblo the widespread use and importance of makeshift household roof catchment systems was observed (Brand & Bradford 1991). About 85% of households were collecting roof runoff and over three-quarters of them were using rainwater for over half of their domestic needs. Like many of the barrio settlements on the steep peripheral hillsides high above Tegucigalpa, Israel Norte and Villa Nueva were not serviced by the main piped water system.

### RWH in the Barrios of Tegucigalpa, Honduras

Health statistics show that the residents of the barrios are suffering from a number of water related diseases that could be easily avoided with provision of a reliable, clean water supply. Unfortunately, more than 150,000 residents have to find their own water. Although technically unsophisticated and lacking some good health practices, the system shows what urban settlements have done to improve their own lot. Many of the systems make use of recycled or scavenged materials and some examples show high levels of initiative.

Storage: 0.2 cu.m used barrels (upto 3) or 1-2 cu.m open concrete tanks

Storage cost: GB pounds 10 (drum) – GB pounds 18 – small tank

Material: Steel drums on plastered bricks

Lessons: Impact of very small storage is also good, and available containers have been used for this.

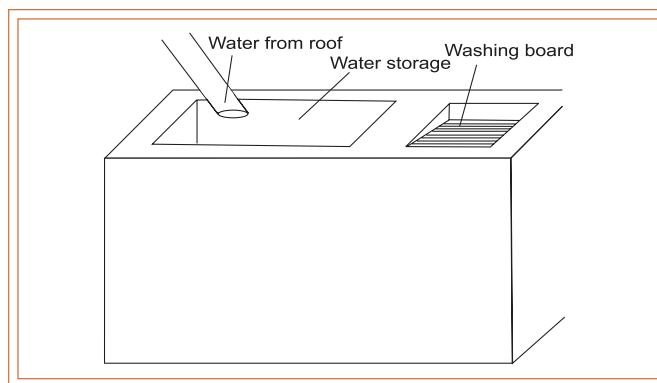
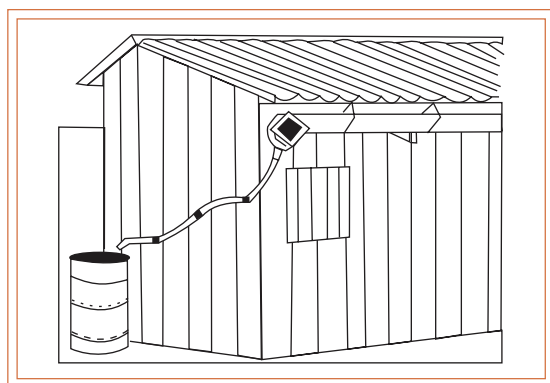

Apart from rainwater, residents here depended on the purchase of trucked water from communal tanks, new boreholes, or water vendors and many poorer families typically spent 30-40% of their income on sub-standard water. Over two-thirds of the 535 households surveyed expressed an interest in upgrading their existing storage tanks usually consisting of a 200 litre oil drum, with a 1000-3000 litre cement tank. Some also wanted to improve roofing and guttering or construct new corrugated iron roofs. These families were prepared to take loans of between \$18 and \$490 to pay for improvements ranging from new gutters to entirely new roof, gutter, and tank systems. In most cases such loans could have been administered through an existing scheme and, in theory at least, repaid over 2 years with savings from the water purchases no longer required.

### Island of Hawaii, USA

At the U.S. National Volcano Park, on the Island of Hawaii, rainwater utilisation systems have been built to supply water for 1,000 workers and residents of the park and 10,000 visitors per day. The Park's rainwater utilisation system includes the rooftop of a building with an area of 0.4 hectares, a ground

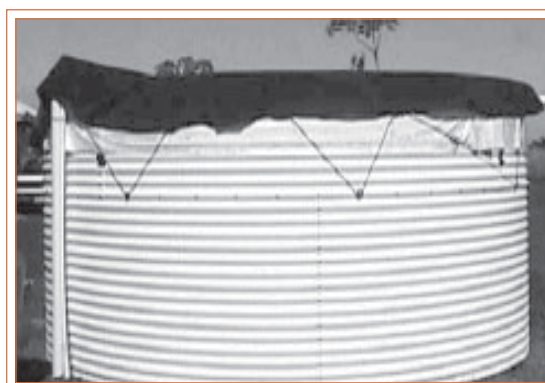

catchment area of more than two hectares, storage tanks with two reinforced concrete water tanks with 3,800 m<sup>3</sup> capacities each, and 18 redwood water tanks with 95 m<sup>3</sup> capacities each. Several smaller buildings have their own rainwater utilisation systems as well. A water treatment and pumping plant was built to provide users with good quality water.

## AFRICA

Although in some parts of Africa rapid expansion of rainwater catchment systems has occurred in recent years, progress has been slower than Southeast Asia. This is due in part to the lower rainfall and its seasonal nature, the smaller number and size of impervious roofs and the higher costs of constructing catchment systems in relation to typical household incomes.

The lack of availability of cement and clean graded river sand in some parts of Africa and a lack of sufficient water for construction in others, add to overall cost. Nevertheless, rainwater collection is becoming more widespread in Africa with projects currently in Botswana, Togo, Mali, Malawi, South Africa, Namibia, Zimbabwe, Mozambique, Sierra Leone and Tanzania among others. Kenya is leading the way. Since the late 1970s, many projects have emerged in different parts of Kenya, each with their own designs and implementation strategies.

These projects, in combination with the efforts of local builders called “fundis” operating privately and using their own indigenous designs, have been responsible for the construction of many tens of thousands of rainwater tanks throughout the country. Where cheap, abundant, locally available building materials and appropriate construction skills and experience are absent; ferro-cement tanks have been used for both surface and sub-surface catchment.

### Dar es Salaam, Tanzania

Due to inadequate piped water supplies, the University of Dar es Salaam has applied rainwater harvesting and utilisation technology to supplement the piped water supply in some of the newly built staff housing. Rainwater is collected from the hipped roof made with corrugated iron sheets and led into two “foul” tanks, each with a 70 litre capacity. After the first rain is flushed out, the foul tanks are filled up with rainwater. As the foul tanks fill up, settled water in the foul tanks flows to two underground storage tanks with a total capacity of 80,000 litres. Then the water is pumped to a distribution tank with 400 litres capacity that is connected to the plumbing system of the house.

The principles for the operation of this system are:

- ❖ Only one underground tank should be filled at a time;
- ❖ While one tank is being filled, water can be consumed from the other tank,
- ❖ Rainwater should not be mixed with tap water;
- ❖ Underground storage tanks must be cleaned thoroughly when they are empty;
- ❖ In order to conserve water, water should only be used from one distribution tank per day.



Many sources of pollution can affect rainwater catchment systems. A few of the contamination problems you need to consider when living on rainwater catchment are illustrated in this drawing. Few of these problems are insurmountable. With awareness, planning, and good catchment systems management practices, your water supply can be improved.

Erupting volcanoes, fireplaces, and other sources of combustion produce smoke and fumes containing particulate matter that can land on your roof and wash into your water supply. Gases from these sources also can combine with moisture in the atmosphere to produce acid rain.

Agricultural fields nearby can be source of pesticide drift if sprays are applied incorrectly.



Trees and shrubs that touch or overhang the roof and gutters can cause several problems. Plant debris can block gutters and downspouts so water can't get to the tank. Decomposing organic materials provide nutrients for micro organisms and can taint the water so that its color and taste become unappealing. Plants also host insects, birds, and other animals whose wastes and corpses can contaminate your water supply. Rats in particular are a potential source of disease, and they are adept at getting onto roofs via branches and utility wires.

Downspouts that are not properly designed hold water between rains. This water is not affected by water purification treatments applied to the tank, and it stagnates while waiting for the next rain to flush it into the water supply.

Uncontrolled tank overflow can undermine tank's foundations, resulting in eventual tank collapse. This runoff needs to be directed to avoid causing problems on your property or your neighbors.

Birds delight in the baths formed by sagging mesh tank covers or blocked gutters. Many insects, particularly mosquitoes, find these pools perfect for breeding. Holes in the cover allow critters direct access to your stored water. Rodents and larger animals such as chickens and cats have fallen through holes in tank covers and drowned.



## Uganda

*“God must think were crazy. We let the rain fall off our roofs onto our soil; it washes the soil away and flows to the bottom of the hill. We then climb down the hill and carry it back up to drink.” (Ugandan project worker)*

### Underground Storage Cistern : 4-10 cu.m.

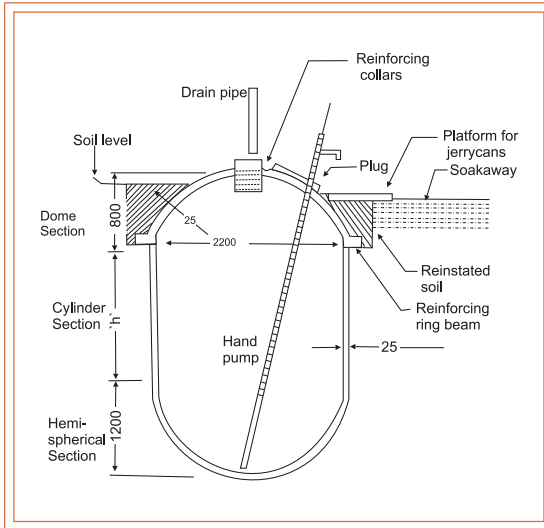

This tank or cistern was developed in Uganda by members of the Development Technology Unit (Warwick University) and members of the Uganda Rural Development and Training programme (URDT). Work is still continuing on the refinement of the tank. URDT is a service NGO located at Kagadi in mid-Western Uganda. Several of these cisterns were built and tested with the aim of developing a low cost (under US\$ 150), alley, domestic, and water storage technology for the surrounding region.

Catchment: Varying

Storage: 4-10 cu.m.

Storage cost: GBP 90 (8 cu.m.)

Material: cement mortar

Lessons: Underground tanks – very thin walls are possible in appropriate soil; unreinforced mortar dome roof – lower cost due to no steel; ground as formwork – reduced cost amortization of formwork

*400 litre water storage jars being constructed as part of the water quality testing experiments in Uganda*

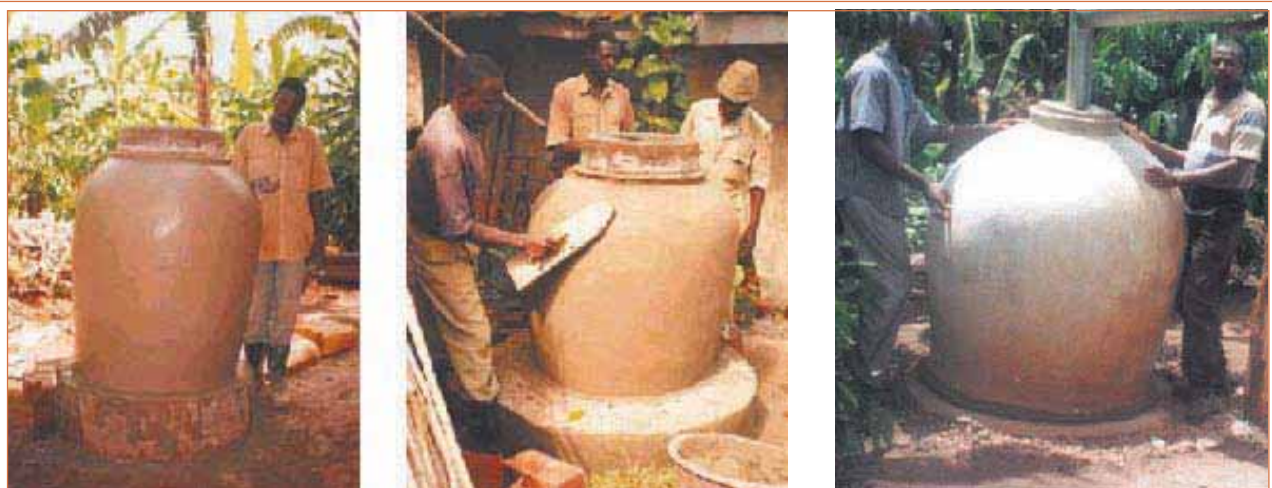

Ref: International Rainwater Catchment Systems Association

### Rakai, Uganda

Climate: Tropical, Bimodal; Rainwater used as supplementary source

Rakai is in the southern hills of Uganda. It has a bimodal rainfall pattern and hence a dry season of only 2 months. A local women's group, trained in tank making by a Kenyan women's group, has made a large number of small (700 litre) jars to supplement their water use, particularly in the wet season when they provide the bulk of water needs. The sub \$70 cost of the systems are financed by a self-sustaining revolving fund.

### Construction of Stabilized Soil Tanks in Kampala, Uganda

In March 2000, 2 experimental cylindrical water tanks were built at Kawempwe, Kampala in collaboration with Dr. Muses Muzaazi, a lecturer at Makerere University. Both were built above ground of curved stabilized soil blocks with end interlocking (280 x 140 x 110 mm) made with an Approtec (Kenyan) manual block press. The soil used was a red somewhat pozzolanic local soil previously known to make strong blocks. The tanks were built on concrete plinths, lined with 'waterproofed' mortar (3 parts sand, 1 part cement and .02 parts 'leak seal' waterproofing compound). There was no metal reinforcing



Each of the PBG tanks were fitted with a thin sheel ferrocement cover. The last illustration shows a completed tank showing inlet pipe and handpump for extracting water

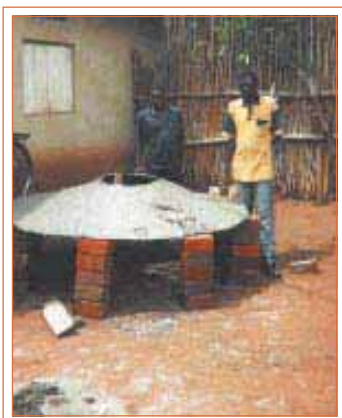

## Kenya

Kenya is leading the way. Since the late 1970s, many projects have emerged in different parts of Kenya, each with their own designs and implementation strategies. These projects, in combination with the efforts of local builders called “fundis” operating privately and using their own indigenous designs, have been responsible for the construction of many tens of thousands of rainwater tanks throughout the country. Where cheap, abundant, locally available building materials and appropriate construction skills and experience are absent; ferro-cement tanks have been used for both surface and sub-surface catchment.

Rainwater tanks constructed by local builders are called “fundis” in Kenya.



UNEP: National Environment Technology Centre

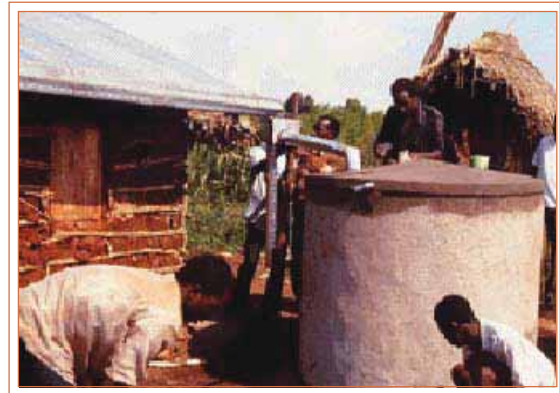

Women as local scale water managers: rock catchment construction in Kenya (Gnadlinger)



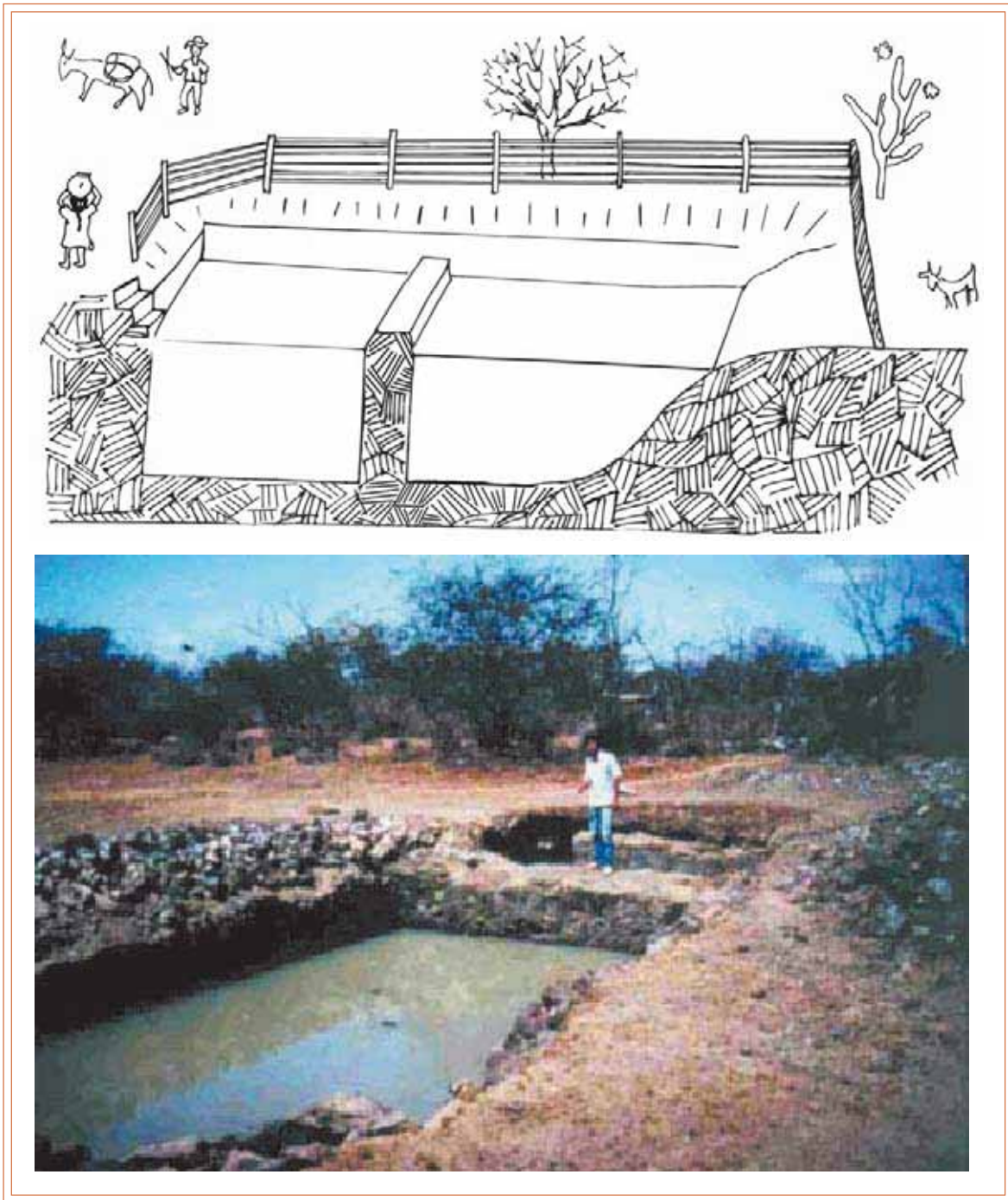

Hand dug rock cistern: In different parts of the semi-arid region there is a revival of hand-dug rock cisterns; a traditional way to harvest water for the dry season. The water is normally used for animals, but after filtering can be used for drinking purposes as well

# Rainwater Harvesting for Artificial Recharge to Ground Water

## Rainwater Harvesting for Artificial Recharge to Ground Water

Of the many ways of harvesting water from rain, there are three main water-harvesting systems that can be adopted in practice with the involvement of the local people and with the maximum value for the resources they demand. These include

- ❖ Rooftop harvesting
- ❖ Surface run-off
- ❖ Underground harvesting

Each of these systems has its own characteristics, limitations and advantages.

### Design Considerations

Three most important components, which need to be evaluated for designing the rainwater harvesting structure, are:

1. Hydrogeology of the area including nature and extent of aquifer, soil cover, topography, depth to water levels and chemical quality of ground water.
2. Area contributing for runoff i.e. how much area and land use pattern, whether industrial, residential or green belts and general built up pattern of the area.
3. Hydrometeorological characteristics viz. rainfall duration, general pattern and intensity of rainfall.

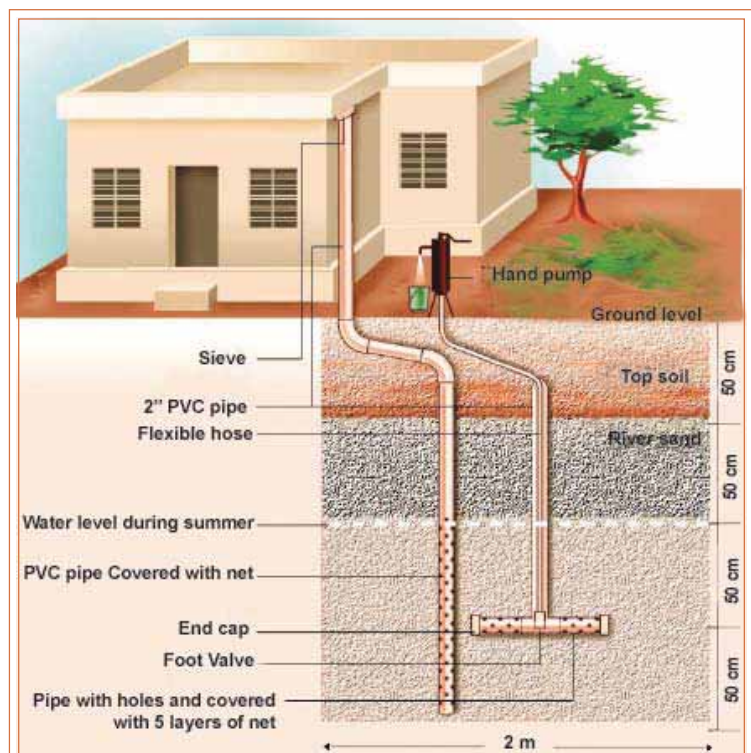



## Design Criteria of Recharge Structures

Recharge structures should be designed based on availability of space, availability of runoff, depth to water table and lithology of the area.

### Assessment of Runoff

The runoff should be assessed accurately for designing the recharge structure and may be assessed by the following formula.

$$\text{Runoff} = \text{Catchment area} \times \text{Runoff Coefficient} \times \text{Rainfall}$$

### Runoff Coefficients

Runoff coefficient plays an important role in assessing the runoff availability and it depends upon catchment characteristics. General values are tabulated below which may be utilized for assessing the runoff availability.

Type of catchment	Runoff coefficient
Roof top	0.75 - 0.95
Paved area	0.50 - 0.85
Bare ground	0.10 - 0.20
Green area	0.05 - 0.10

## Techniques for Artificial Recharge in Urban Settlements

### Recharge Pits

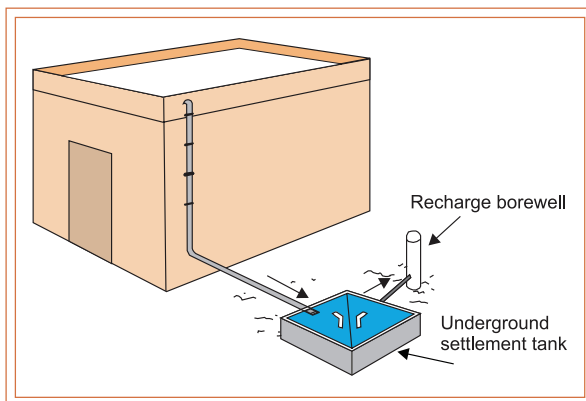

Recharge pits are constructed for recharging the shallow aquifers. These are constructed generally 1 to 2 m. wide and 2 to 3 m. deep. After excavation, the pits are refilled with pebbles and boulders as well as coarse sand. The construction details are given in the drawing below.

As is indicated in the drawing, the filter material should be filled in graded form.

Boulders at the bottom, gravels in between and coarse sand at the top so that the silt content that will come with the runoff will be deposited on the top of the coarse sand layer and can easily be removed. If a clayey layer is encountered at a shallow depth, it should be punctured with an auger hole and the auger hole should be refilled with fine gravel 3 to 6 mm in size.

- ❖ 1 to 2 m wide and 2 to 3 m deep recharge pits are constructed to recharge the shallow aquifer.
- ❖ After excavation, the pit is refilled with boulders and pebbles at the bottom, followed by gravel and then sand at the top.

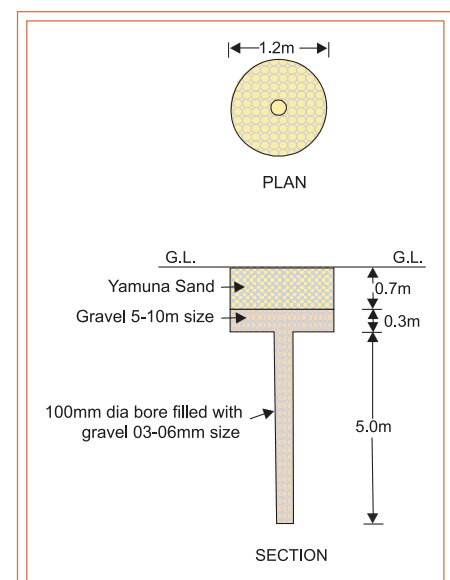

- ❖ The water collected from the rooftop is diverted to the pit through a drainpipe.
- ❖ The recharge pit can be of any shape i.e. circular, square or rectangular. If the pit is trapezoidal in shape, the side slopes should be steep enough to avoid silt deposition.
- ❖ The method is suitable for small buildings having a rooftop area up to 100 sq.m.

### Percolation Pits / Soakaways

Percolation pits are one of the easiest and most effective means of rainwater harvesting. These are generally not more than 60 x 60 x 60 cm pits generally designed on the basis of expected runoff. They are filled with pebbles or brick jelly and river sand and are covered with perforated concrete slabs wherever necessary



Percolation pits are made to make the rainwater directly enter into the aquifer. The structure is covered with perforated concrete slabs in paved areas. If the depth of clay soil is more, recharge through percolation pits with bore is preferable. This bore can be at the centre of the square pit and is filled with pebbles and the top portion with river sand and covered with perforated concrete slab. Depending on the lithology, necessary casing may be provided in the recharge shaft to avoid clogging.

Roof water and surface water from buildings can be diverted to percolation pits. It is good to have a minimum of one percolation pit for every 20 sq.m. in every house with open area.

A **soakaway** is a bored hole of up to 30 cm diameter drilled in the ground to a depth of 3 to 10 m. The soakaway can be drilled with a manual auger unless hard rock is found at a shallow depth. The borehole can be left unlined if a stable soil formation like clay is present. In such a case, the soakaway may be filled up with a filter media like brickbats. In unstable formations like sand, the soakaway should be lined with a PVC or MS pipe to prevent collapse of the vertical sides. The pipe may be slotted/perforated to promote percolation through the sides.

A small sump is built at the top end of the soakaway where some amount of runoff can be retained before it infiltrates through the soakaway. Since the sump also acts like a buffer in the system, it has to be designed on the basis of expected runoff.

### Dug cum Bore Wells

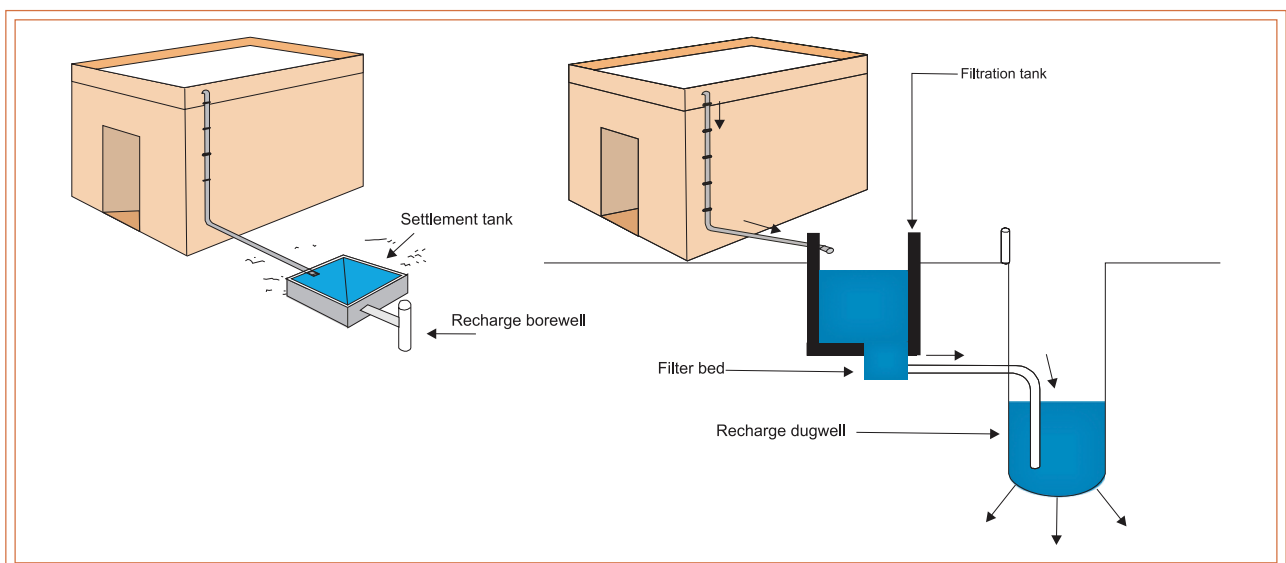

The above figures show typical systems of recharging wells directly with rooftop runoff. Rainwater that is collected on the rooftop of the building is diverted by drainpipes to a settlement or filtration tank, from which it flows into the recharge well (bore well or dug well).

If a borewell is used for recharging, then the casing (outer pipe) of the borewell should preferably be a slotted or perforated pipe so that more surface area is available for the water to percolate. Developing a borewell would increase its recharging capacity (developing is the process where water or air is forced into the well under pressure to loosen the soil strata surrounding the bore to make it more permeable). If a dugwell is used for recharge, the well lining should have openings (weep-holes) at regular intervals to allow seepage of water through the sides. Dugwells should be covered to prevent mosquito breeding and entry of leaves and debris. The bottom of recharge dugwells should be desilted annually to maintain the intake capacity.

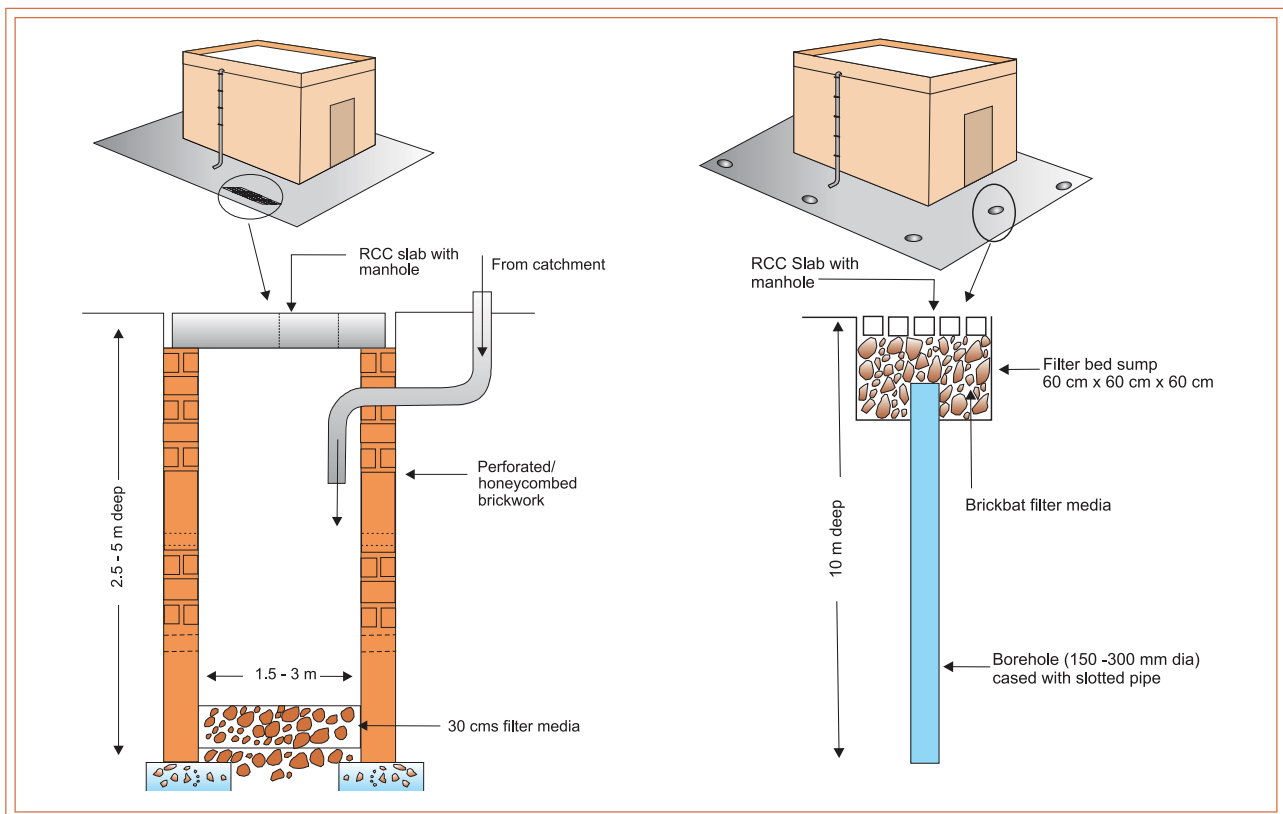

Location of recharge pit in a building area and detailed section of pit

### Quality of Water Recharged

The quality of water entering the recharging wells can be ensured by providing the various elements in the system. These are:

- ❖ Filter mesh at entrance point of rooftop drains
- ❖ Settlement chamber
- ❖ Filter bed

### Recharge Trenches

Recharging through recharge trenches, recharge pits and soakaways is simpler compared to recharge through wells. Fewer precautions have to be taken to maintain the quality of the rainfall runoff. For these types of structures, there is no restriction on the type of catchment from which water is to be harvested, i.e., both paved and unpaved catchments can be tapped.

A recharge trench is a continuous trench excavated in the ground. These are constructed when the permeable strata is available at shallow depths. The trench may be 0.5 to 1 m. wide, 1 to 1.5 m. deep and 10 to 20 m. long depending upon availability of water. It is back filled with filter materials like pebbles, boulders or broken bricks. In case a clay layer is encountered at shallow depth, a number of auger holes may be constructed and back filled with fine gravels. The length of the recharge trench is decided as per the amount of runoff expected. The recharge trench should be periodically cleaned of accumulated debris to maintain the intake capacity. In terms of recharge rates, recharge trenches are relatively less effective since the soil strata at depth of about 1.5 metres is generally less permeable. For recharging through recharge trenches, fewer precautions have to be taken to maintain the quality of the rainfall runoff. Runoff from both paved and unpaved catchments can be tapped.

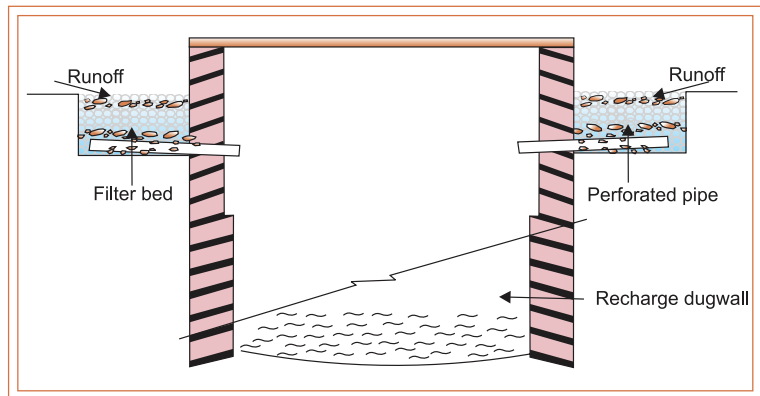

Recharge assembly for dugwell with runoff from ground areas (non-rooftop)

### Design of a Recharge Trench

The methodology of design of a recharge trench is similar to that for designing a settlement tank. The difference is that the water holding capacity of a recharge trench is less than its gross volume because it is filled with porous material. A factor of loose density (voids ratio) of the media has to be applied to the equation.

A recharge trench can be designed using the method given below:

Area of rooftop catchment (A) = 150 sq.m.

Peak rainfall in 15 min (r) = 30 mm (0.030 m)

Runoff coefficient (C) = 0.85

Voids ratio (D) = 0.5 (assumed)

Required capacity of recharge tank

$$\begin{aligned}
 &= (A \times r \times C) / D \\
 &= (150 \times 0.03 \times 0.85) / 0.5 \\
 &= 7.65 \text{ cu.m. (7,650 litres)}
 \end{aligned}$$

The voids ratio of the filler material varies with the kind of material used, but for the commonly used materials like brickbats, pebble and gravel, a voids ratio of 0.5 may be assumed.

In designing a recharge trench, the length of the trench is an important factor. Once the required capacity is calculated as illustrated above, the length can be calculated by considering a fixed depth and width.

- ❖ Recharge trench is constructed when permeable strata of adequate thickness are available at shallow depth.

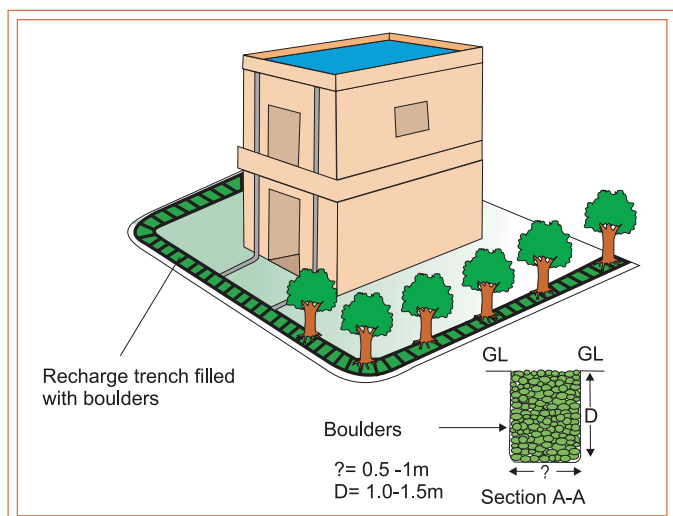

- ❖ The trench is constructed across the land slope along the boundary walls.
- ❖ The trench may be 0.5 to 1 m wide, 1 to 1.5 m deep and 10 to 20 m long depending upon the availability of land and rooftop area.
- ❖ The trench is filled with boulders at the bottom followed by pebbles and by sand at the top.
- ❖ The water collected from the roof is diverted through the drainpipe to the trench.
- ❖ The trench should be periodically cleaned.
- ❖ This method is suitable for buildings having rooftop area of 200 to 300 sq.m.

### Recharge Troughs

To collect the runoff from paved or unpaved areas draining out of a compound, recharge troughs are commonly placed at the entrance of a residential/institutional complex. These structures are similar to recharge trenches except for the fact that the excavated portion is not filled with filter materials. In order to facilitate speedy recharge, boreholes are drilled at regular intervals in this trench. In design part, there is no need of incorporating the influence of filter materials.

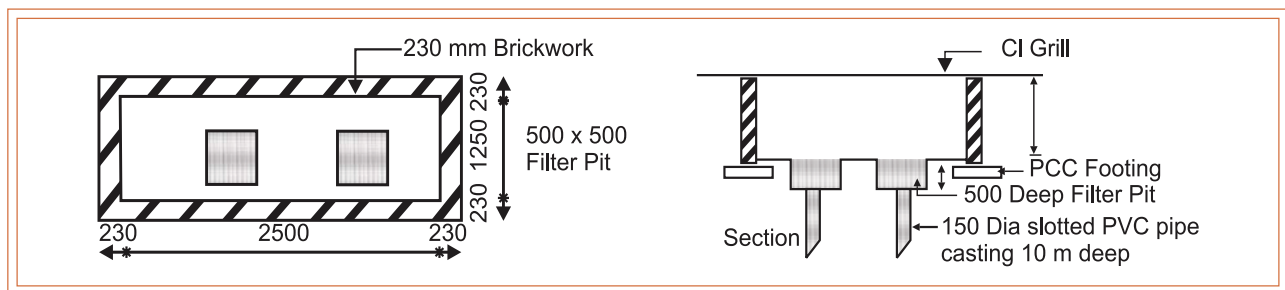

This structure is capable of harvesting only a limited amount of runoff because of the limitation with regard to size.

### Modified Injection Well

In this method water is not pumped into the aquifer but allowed to percolate through a filter bed, which is comprised of sand and gravel. A modified injection well is generally a borehole, 500 mm diameter, which is drilled to the desired depth depending upon the geological conditions, preferably 2 to 3 m below the water table in the area. Inside this hole a slotted casing pipe of 200 mm diameter is inserted. The annular space between the borehole and the pipe is filled with gravel and developed with a compressor till it gives clear water. To stop the suspended solids from entering the recharge tubewell, a filter mechanism is provided at the top.

### Recharging Through Defunct Open Wells, Hand Pumps and Bore Wells

#### Abandoned Dug wells

Existing abandoned dug wells may be utilized as recharge structures after cleaning and desilting them. For removing the silt contents, the runoff water should pass either through a desilting chamber or filter chamber.

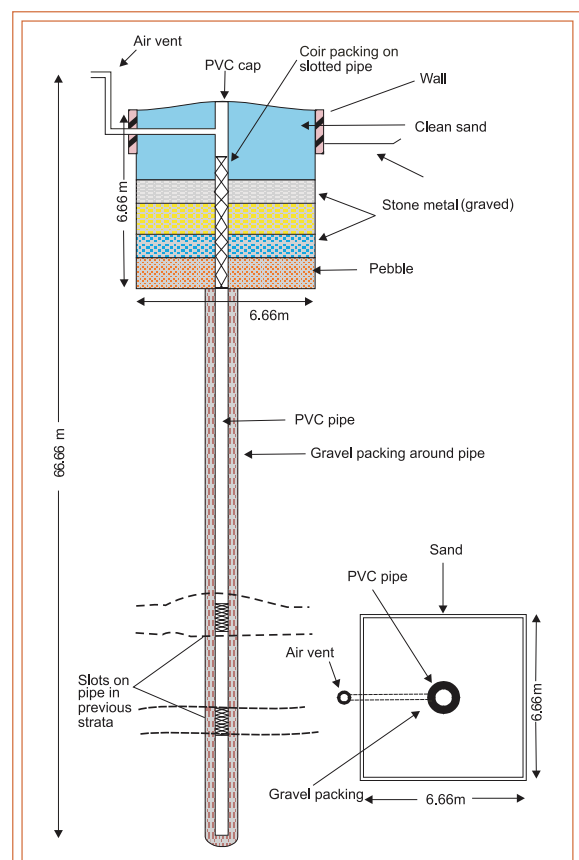



- ❖ Recharge water is guided through a pipe to the bottom of the dry/unused dug well or below the water level to avoid scouring of bottom and entrapment of air bubbles in the aquifer.
- ❖ The bottom of the dug well should be cleaned and all fine deposits should be removed before its use for recharge.
- ❖ Recharge water should be silt free.
- ❖ The well should be cleaned regularly.
- ❖ Periodic chlorination is required in order to control bacteriological contamination.
- ❖ This method is suitable for large buildings having the roof area of more than 1000 sq.m.

### Abandoned Hand Pumps

The existing abandoned hand pumps may be used for recharging the shallow / deep aquifers, if the availability of water is limited. Water should pass through filter media before diverting it into hand pumps.

- ❖ Water is diverted from the rooftop to the hand pump through a pipe 50 to 100 mm in diameter.
- ❖ For a running hand pump, a closing valve is fitted in the conveyance system near the hand pump to avoid entry of air in the suction pipe.
- ❖ Recharge water should be silt free.
- ❖ During the period the water is being recharged, water extracted from the hand pump should be used after proper chlorination.
- ❖ This method is suitable for small buildings having roof area up to 150 sq.m.



### Abandoned Tube Well

Abandoned tube wells may be used for recharging the shallow / deep aquifers. These tube wells should be redeveloped before use as recharge structures. Water should pass through the filter media before diverting it into recharge tube well.

#### Defunct Borewell

- ❖ A defunct bore well can be used for recharging the collected water.
- ❖ A circular pit of 1 m diameter for a depth of 0.6 m below ground level is dug around the bore well.
- ❖ The bore and the pit are filled with broken bricks.
- ❖ The top 0.3 m of the pit is filled with sand.
- ❖ The circular pit is covered with a perforated slab at the top.
- ❖ The slab requires regular cleaning so as to keep its holes open to receive water.

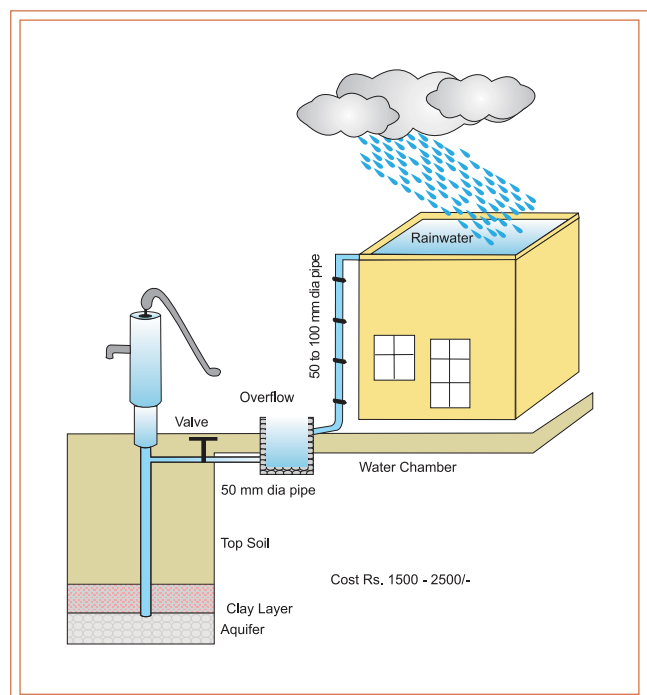

## Settlement Tank

Settlement tanks are used to remove silt and other floating impurities from rainwater. A settlement tank is like an ordinary storage container having provisions for inflow (bringing water from the catchment), outflow (carrying water to the recharge well) and overflow. A settlement tank can have an unpaved bottom surface to allow standing water to percolate into the soil.

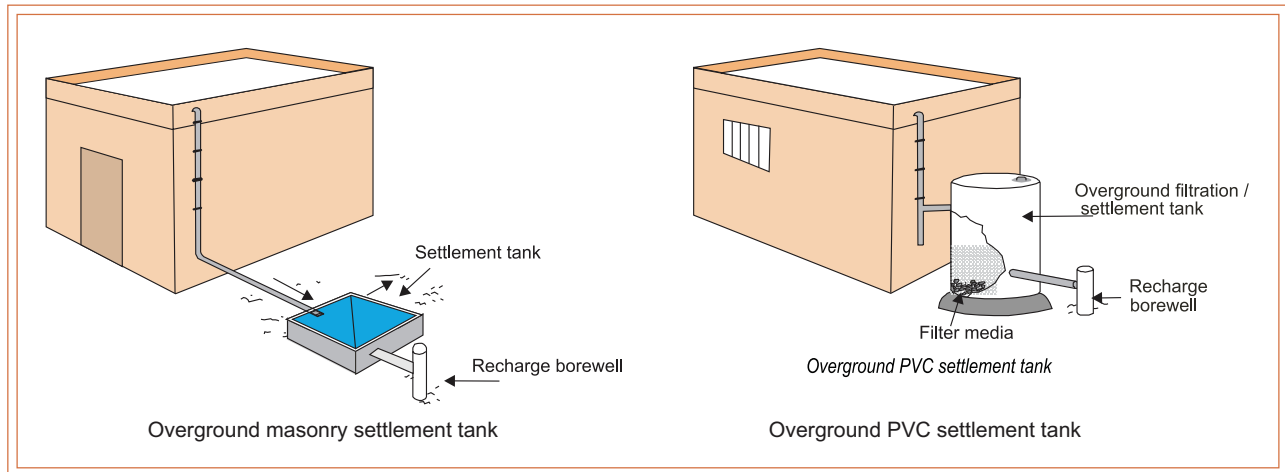

Apart from removing silt from the water, the desilting chamber acts like a buffer in the system. In case of excess rainfall, the rate of recharge, especially of bore wells, may not match the rate of rainfall. In such situations, the desilting chamber holds the excess amount of water till it is soaked up by the recharge structure.

### Options for Settlement Tank

Any container with adequate storage capacity can be used as a settlement tank. Generally, masonry or concrete underground tanks are preferred since they do not occupy any surface area. Old disused tanks can be modified to be used as settlement tanks.

For over ground tanks, pre-fabricated PVC or ferrocement tanks can be used. Pre-fabricated tanks are easier to install, compared to masonry and concrete tanks.

### A Settlement Chamber

In case of excess rainfall, the rate of recharge, especially of bore wells, may not match the rate of rainfall. In such situations, the desilting chamber holds the excess amount of water till it is soaked up by the recharge structure. Thus, the settlement chamber acts like a buffer in the system. Any container, (masonry or concrete underground tanks, old unused tanks, pre-fabricated PVC or ferrocement tanks) with adequate storage capacity can be used as settlement tanks.



### Design Parameters for Settlement Tank

For designing the optimum capacity of the tank, the following aspects have to be considered:

- ❖ Size of the catchment
- ❖ Intensity of rainfall
- ❖ Rate of recharge

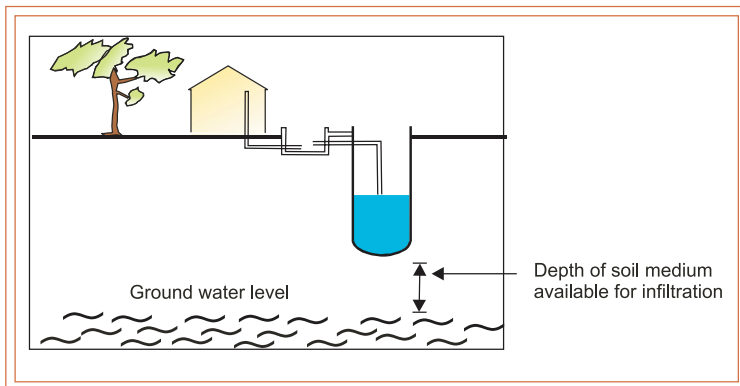

Recharge wells should preferably be shallower than the water table

Since the desilting tank also acts as buffer tank, it is designed such that it can retain a certain amount of rainfall, since the rate of recharge may not be comparable with the rate of runoff. The capacity of the tank should be enough to retain the runoff occurring from conditions of peak rainfall intensity. In Delhi, peak hourly rainfall is 90 mm (based on 25 year frequency). The rate of recharge in comparison to runoff is a critical factor. However, since accurate recharge rates are not available without

detailed geohydrological studies, the rates have to be assumed. The capacity of the recharge tank is designed to retain runoff from at least 15 minutes rainfall of peak intensity (For Delhi, 22.5 mm/hr, say, 25 mm)\*.

To illustrate, let us suppose the following data are available:

Area of rooftop catchment (A) = 150 sq.m.

Peak rainfall in 15 min (r) = 30 mm (0.03 m)

Runoff coefficient (C) = 0.85

Then, capacity of desilting tank =  $A \times r \times C$

$$= 150 \times 0.03 \times 0.85$$

$$= 3.825 \text{ cu.m. (3,825 litres)}$$

### Typical Design of Trench cum Injection Wells

The design is specific to location. Size of storage cum filter tank varies from place to place and depending upon the available runoff water from the catchment. Depth of the tube well also varies from place to place and is normally taken down to the first granular saturated sandy formation.

### Permeable Surfaces

Unpaved surfaces have a greater capacity of retaining rainwater on the surface. A patch of grass would retain a large proportion of rainwater falling on it, yielding only 10-15 per cent as runoff. A considerable amount of water retained on such a

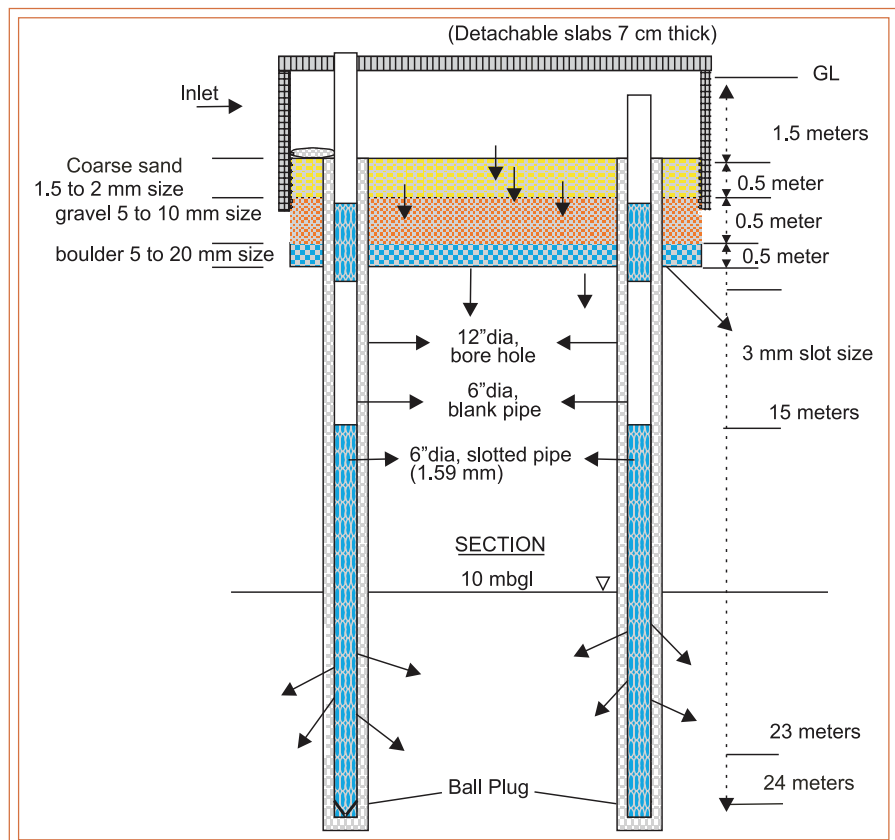

surface will naturally percolate in the ground. Such surfaces contribute to the natural recharge of ground water. If paving of ground surfaces is unavoidable, one may use pavements which retain rainwater and allow it to percolate into the ground.

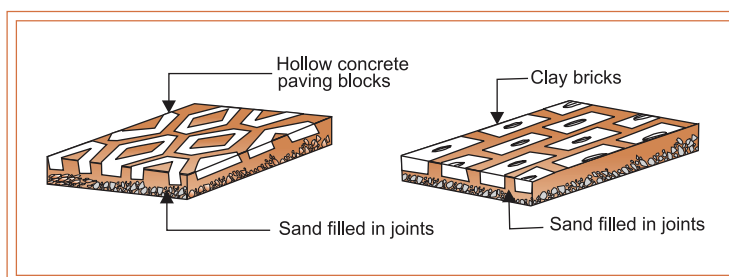

### Cost of Recharge Structures/Cost of Water Harvesting

Typically, installing a water harvesting system in a building in India would cost between Rs. 2,000 (US\$ 50) to Rs. 30,000 (US\$ 750) for buildings of about 300 sq. m. It is difficult to make an exact estimate of cost because it varies widely depending on the availability of existing structures like wells and tanks which can be modified to be used for water harvesting. The cost estimate mentioned above is for an existing building.

The cost of each recharge structure varies from place to place. The approximate costs of the following structures in India are estimated as under:

Recharge Structure	Approximate cost (US \$)
Recharge pit	100 - 200
Recharge trench	200 - 400
Recharge through hand pump	60 - 100
Recharge through dug well	250 - 320
Recharge well	2000 - 3200
Recharge shaft	2400 - 3400
Lateral shaft with bore well	Shaft per m. 100 - 150 Bore well 1000 - 1400

Source: CSE Website

The cost of recharge structures can be worked out on the basis of the local rates of construction activities such as excavation in soils, excavation in rock, brickwork and the cost of materials such as plain cement concrete, reinforced cement concrete, GI Piping, PVC Piping, etc.

The cost estimates for installing a rainwater harvesting system on existing buildings would be comparatively higher than the cost of the system incorporated during the construction of the building itself.

### Scale of Water Harvesting

Most methods described in this guidebook are applicable both for a single building as well as for an establishment level. However, the same principles can be applied for implementing water harvesting on a larger scale, say, a residential colony or an institutional cluster. To an extent, the nature of structures and design parameters remain the same; the physical scale and number of structures may increase corresponding to the size of catchment.

To control the total amount of runoff received by a large-scale system, the catchment can be subdivided into smaller parts. A locality-level water harvesting system illustrated in figure - shows how the runoff from

individual houses can be dealt with at the building-level itself, while remaining runoff from the storm water drain (which drains water from roads and open areas) can be harvested by constructing recharge structures in common areas.

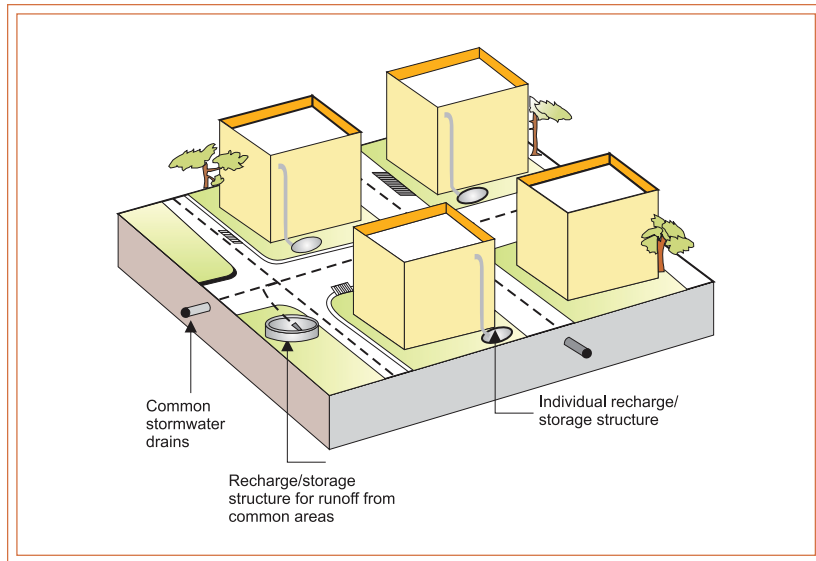

Trapping storm water drains in a community-level system



## Planning and Monitoring of Artificial Recharge Projects

The artificial recharge to ground water aims at augmentation of the ground water reservoir by modifying the natural movement of surface water utilizing suitable civil construction techniques. The basic purpose of artificial recharge of ground water is to restore supplies from aquifers depleted due to excessive ground water development. Besides enhancing the sustainable yield in areas where over development has depleted the aquifer, the other objectives include conservation and storage of excess surface water for future requirements and to improve the quality of existing ground water through dilution.

The sub-surface reservoirs are very attractive and technically feasible alternatives for storing surplus rainwater runoff. The sub-surface reservoirs can store substantial quantity of water and therefore, are considered as “warehouses” for storing water. They are environment friendly and economically viable. The underground storage of water also has a beneficial influence on the existing ground water regime. Aquifer recharging may also result in rising of water levels and consequently, reduction in lifting cost and energy saving. The structures required for recharging ground water reservoirs are of small dimensions and cost-effective, such as check dams, percolation tanks, surface spreading basins, pits, sub-surface dykes, etc.

### Basic Requirement for Artificial Recharge Projects

There are two basic requirements for recharging the ground water reservoirs. These are

- ❖ Availability of surplus rainwater runoff in space and time;
- ❖ Suitable hydrogeological environment and sites for creating sub-surface reservoir through cost-effective artificial recharge techniques

The aquifers best suited for artificial recharge are those which absorb large quantities of water and do not release them quickly. Therefore, the hydrogeological situation in each area needs to be appraised with a view to assess the recharge capabilities of the underlying hydrogeological formations. There are two effects of artificial recharge ground water reservoirs viz.

- ❖ Rising water level and
- ❖ Increment in the total volume of the ground water reservoir

## Planning of Artificial Recharge Projects

The artificial recharge projects are site specific. The first step in planning the project is to demarcate the area of recharge based on the local hydrogeological and hydrological environments. The artificial recharge of ground water is generally useful in areas where

- ❖ Ground water levels are declining on regular basis
- ❖ Substantial amount of aquifer has already been desaturated
- ❖ Availability of ground water is inadequate in lean months
- ❖ Salinity ingress is taking place

In order to plan the artificial recharge schemes, the following studies are needed:

**Hydrometeorological Studies:** Hydrometeorological studies are undertaken to decipher the rainfall pattern, evaporation losses and climatological features.

**Hydrological Studies:** Hydrological studies ascertain the availability of source water for the purpose of recharging the ground water reservoir. Four types of source water may be available for artificial recharge viz. (i) *In situ* precipitation on the watershed (ii) Surface (canal) supplies from large reservoirs located within basin (iii) Surface supplies through trans basin water transfer (iv) Treated municipal and industrial waste waters.

Thus, hydrological studies are undertaken to work out surplus rainwater runoff, which can be harnessed as source water for artificial recharge. These studies also determine a) The quantity that may be diverted for artificial recharge b) The time for which the source water will be available c) The quality of source water and the pre-treatment required and d) Conveyance system required to bring the water to the recharge site.

**Soil Infiltration Studies:** Infiltration is defined as the process of water entering into a soil through the soil surface. The maximum rate at which water can enter soil at a particular point under a given set of conditions is called the infiltration capacity. Infiltration capacity depends on many factors such as type of soil, moisture contents, organic matter, vegetative cover, season, air and entrapment, formation of surface seals or crusts etc. Of the soil characteristics, porosity determines storage capacity. Infiltration tends to increase with porosity. Surface conditions also have a marked effect on the infiltration process. Infiltration is critically inter-linked with the phenomenon of water evaluation in the vadose zone which includes wetting front propagation. Through soil infiltration studies, maps are prepared for determining infiltration rates of soils which help in designing suitable artificial recharge structures.

**Hydrogeological Studies:** A correct understanding of the hydrogeology of an area is of prime importance in successful implementation of any artificial recharge scheme. A detailed hydrogeological study is imperative to know precisely the promising hydrogeological units for recharge and to correctly decide on the location and type of structures to be constructed in field.

**Geophysical Studies:** The main purpose of applying geophysical methods for the selection of appropriate site for artificial recharge studies is mostly to help and assess the unknown subsurface hydrogeological conditions economically, adequately and unambiguously. Generally the prime task is to complement the exploratory programme. Mostly it is employed to narrow down the target zone, pinpoint the probable site for artificial recharge structure and its proper design.

**Quality of Source Water:** The quality of raw waters that are available for recharge generally require some sort of treatment before being used in recharge installations. Therefore, the chemical and bacteriological analysis of source water as well as that of ground water is essential.

There is also the danger that suspended matter may clog the soil in different ways. Therefore, the waters that are to be used in recharge projects should be silt free. (*Silt is defined as the content of undissolved solid matters, usually measured in mg/l, which settles in stagnant water with velocities that do not exceed 0.1 m/hr*)

### Assessment of Potential for Ground water Recharge

Based on the hydrogeological and geophysical surveys, the thickness of potential unsaturated zone for recharge can be worked out to assess the potential for artificial recharge in terms of volume of water which can be accommodated in a zone vis-à-vis source water availability. The studies should bring out the potential of the unsaturated zone in terms of total volume which can be recharged.

### Monitoring Mechanism for Artificial Recharge Projects

The monitoring of water levels and water quality is of great importance in all schemes of artificial recharge of ground water. Data are required for regular monitoring of the efficacy of structures constructed for artificial recharge. This should help in taking effective measures for scientific management of ground water.

### Water Level Monitoring

Where the surface water bodies are hydraulically connected with the ground water aquifer, which is being recharged, it is advisable to monitor the water level profiles of both surface water and ground water. The periodic monitoring of water levels can demarcate the zone of benefit.

### Water Quality Monitoring

The monitoring of water quality during the implementation of artificial recharge schemes is essential to maintain the quality standards for specified uses of the augmentation resource.

## Impact Assessment

The impact assessment of artificial recharge schemes should generally enumerate aspects such as:

- ❖ Conservation and harvesting of surplus rainwater runoff in ground water reservoirs
- ❖ Rise in ground water levels due to additional recharge to ground water
- ❖ Provision of water in lean months
- ❖ Impact on cropping pattern due to additionality of ground water
- ❖ Impact on the green vegetation cover
- ❖ Improvement in the quality of ground water due to dilution
- ❖ Indirect benefits in terms of improvement in fauna and flora, influx of migratory birds etc.

### Checklist for preparation of Artificial Recharge Projects

At the time of planning artificial recharge projects following checklist may be kept in view:

- ❖ Establishing the need for artificial recharge
- ❖ Feasibility of economic, financial, environmental and other aspects should be studied beforehand

- ❖ Meteorological and hydrological surveys should be undertaken to determine rainfall intensity and duration, availability of surplus water, sediment load, etc.
- ❖ Regional and site hydrogeological surveys, soil survey and infiltration studies
- ❖ Investigations for construction of structures including foundation conditions of different recharging structures such as percolation tanks, bunds, reservoirs etc; material surveys, soil surveys etc.
- ❖ Land availability/acquisition
- ❖ Location, layout and design details of individual structures
- ❖ Construction programme schedules
- ❖ Financial resources to meet the cost
- ❖ Ecological aspects such as water lobby, inundation of habitated areas and impact on quality of ground water
- ❖ Community participation

### Evaluation Criteria

At the project site, the evaluation criteria for rainwater harvesting is based on assessment of certain facts and availability of data as per format (next page).







# References

1. Handbook on Rainwater Harvesting – Rajiv Gandhi National Drinking Water Mission.
2. Shelter Vol. 5 No. 1 January, 2002 Special Issue on Water and Sanitation – A HUDCO-HSMI Publication.
3. K.R.G. Rainwater Harvesting Foundation Chennai PROFILE – K. R. Gopinath.
4. Making Water Everybody's Business – Anil Agarwal, Sunita Narain and Indira Khurana.
5. Water Supply and Pollution Control Fourth Edition – Warren Viessman, JR.
6. RWH and Artificial Recharge to Ground Water November 2000 – UNESCO.
7. Water Links (Water Harvesters Directory) – CSE.
8. Human Development Report 2003 – UNDP.
9. Water and Sanitation in the World's Cities – UN-HABITAT.
10. RWH A Guide For All – Delhi Jal Board.
11. Census of India 2001 – Data Dissemination Wing, Delhi.
12. Census of India 2001 Provisional Population Totals – Bimla Jindgar, Director of Census Operations, Delhi.
13. New Delhi Master Plan: Vision of a Globalised Metropolis – Times of India Dated – August 11, 2003.
14. Reaping the Rain – Hindustan Times Dated – July 16, 2003.
15. Calder R Ian, (1999). The Blue Revolution-Land And Integrated Water Resources Management-Earthscan Publications Ltd, London.
16. STEM – Centre for Symbiosis of Technology, Environment and Management (2000).
17. A Conceptual Frame for Rainwater Harvesting In Bangalore.
18. Gardner T., Coombes P., Marks R., (2001) – Use Of Rainwater in Australian Urban Environments-Paper for 11th IRCSA.
19. Online material from [www.rainwaterharvesting.org](http://www.rainwaterharvesting.org)
20. Contribution Relating to Rainwater Harvesting – John Gould Independent Expert, New Zealand Prepared for Thematic Review IV.3: Assessment of Water Supply Options.
21. Texas Guide to Rainwater Harvesting – Austin Texas 1997, Second Edition.
22. Closing The Demand-Supply Gap Through Rainwater Harvesting: A Case Study of Sargasan, Gujarat, India – Srinivas Mudrakartha and Shashikant Chopde: Paper presented at UNESCO IHP-IAH Workshop on Evaluation of Recharge Enhancement Projects in Arid & Semi-arid Areas.
23. Asian Development Bank (1998): The Bank's Policy on Water: Working Paper – August 1998.

24. Centre for Science and Environment, New Delhi:
  - ❖ Dying Wisdom: Rise, Fall and Potential of India's Traditional Water Harvesting Systems (1997)
  - ❖ Making Water Everybody's business: Practice and policy of water harvesting edited by Anil Agarwal, Sumita Narayan and Indira Khurana (March 2001)
  - ❖ Down to Earth, Journal of the Centre for Science and Environment, different issues
25. Government of India: National Water Policy, Ministry of Water Resources, New Delhi.
26. Indian Water Resources Society: 1998: Five Decades of Water Resources Development in India, New Delhi.
27. International Conference on Water and Environment, Dublic Statement, Dublic 1992.
28. Planning Commission, New Delhi: Tenth Five Year Plan Document (2002-2007).
29. Vohra B B (1990): Managing India's Water Resources INTACH, New Delhi.
30. World Water Forum (The Hague) Papers.
31. World Water Vision Commission Report: A Water Secure World – Vision to Water, Life and Environment, World Water Council 2000.
32. 1992. IRC Technical Papers Series No 30 titled "Water Harvesting". A Guide for Planners and Project Managers". DANIDA.
33. 2002. SEARNET Briefs No 1, 2, 3. RELMA, Nairobi.
34. 2003. RELMA – SEARNET. Rainwater Exposition. Nairobi.
35. 2002. Proceedings from the 10th International Rainwater Catchments Systems Conference, Manheim.
36. 2003. "Water Harvesting Management - Improving Land Management in Rajasthan, India". Inter-Cooperation/ Swiss Agency for Development & Cooperation.
37. 2004. Alberto Jimenez Merino. Agua para el Desarrollo. Mexico.
38. Vishwanath S., Bangalore, India, Designing Rainwater Harvesting Systems in Urban Environment.
39. 1999. Dr. Makoto Murase, Sumida City Government, Japan, "Creating a Rainwater Utilization Based Society for Sustainable Development"
40. 1995. Group Raindrops, "Rainwater & You – 100 Ways to Use Rainwater",
41. 1999. M. Murase etc. edited by K. Matsushita, in English, "Sustainable Water Strategies for New Development Patterns - Environment in 21st Century and New Development Patterns"
42. 2002, March. People for Rainwater, Sumida City Hall and UNEP/IETC, "Rainwater Harvesting and Utilization - An Environmentally Sound Approach for Sustainable Urban Water Management"
43. 2003, March. People for Rainwater, Skywater - Rain in Japan and Around the World

### Useful websites

- ❖ [www.cseindia.org](http://www.cseindia.org),
  - ❖ [www.irha-h2o.org](http://www.irha-h2o.org),
  - ❖ [www.searnet.org](http://www.searnet.org),
  - ❖ [www.wotr.org](http://www.wotr.org),
  - ❖ [www.malanad.com](http://www.malanad.com),
  - ❖ [www.malanad.org](http://www.malanad.org) and [www.watersustainable.com](http://www.watersustainable.com),
  - ❖ [www.abcmac.org.br](http://www.abcmac.org.br)
1. Rainwater harvesting and purification system.  
<http://www.%20rdop.%20com%20/users%20/krishna/%20rainwater.htm>
  2. Rainwater harvesting in pdf format- vedeo, courtesy of the city of Austin  
<http://www.twdh.state.tx.us/assistance/%20conversation/conversation/rain.htm>

3. Rainwater harvesting in texas-a new water source.... unreliable aquifer.  
[www.twri.tamu.edu/twripubs/wtrsavrs/v3n2/article-1.html](http://www.twri.tamu.edu/twripubs/wtrsavrs/v3n2/article-1.html)
4. Rainwater harvesting in honduras - technical description the harvesting of water from the surface of roofs for domestic or agricultural uses is a technology.  
<http://www.oas.org/sp/prog/chap5-1.htm>
5. Wedc-garnet,tnc/ roofwater-roof water harvesting.  
<http://www.%20iboro.ac.ac.uk/departments/cv/wedc/garnet%20/tncrain.html>
6. Central ground water authority - the official web site of the central ground water authority of india provides a primer on rainwater.  
<http://www.cgwaindia.com/>
7. Rainwater harvesting -elements of casa's rooftop catchment.  
<http://www.ag.arizona.edu/oals/oals%20/dru/waterharvesting.html>
8. Rainwater harvesting systems for mountains by gretchen rupp,pe, extension engineer specialist  
<http://www.mantana.edu/wwwph/pules/mt9707.html>
9. Rainwater harvesting from jade mountain (jm). floating suction filter  
<http://www.%20jademountain.com/waterproducts/rainwatercistamswp.html>
10. Rainwater harvesting: the complete guide to harvesting rainwater for household and landscape needs  
<http://www.oasisdesign.net/books/rainwater%20harvestingarvesting.htm>
11. Software tools for harvesting, storage and utilization of capturing water. cida. combating desertification.  
[www.idre.ca/books/reports/1997/21-oie.html](http://www.idre.ca/books/reports/1997/21-oie.html)
12. Rainwater harvesting-patil 364 22nd wepc conference: discussion paper new delhi, india,1996 rainwater harvesting dr.medha j.dixit and prof. subhash m. patil india  
<http://www.iboro.ac.uk/departments/cv/wede/papers/22/grouph/dixit.plf>
13. Sourcebook harvested rainwater- rainwater harvesting section of sustainable building sourcebook describes the potential for collecting.  
<http://www.greenbuelder.com/source%20book/rain%20water.html>
14. Water wiser -the water efficiency clearing house reuse/recycling & rainwater harvesting-cisterns/rainwater harvesting systems- advanced technologies for commercial buldings.  
<http://www.%20waterwiser.org/template2.page1=reuselinks%20&page2=links-memu>
15. Water wiser - the water efficiency cleaning house rainwater harvesting-texas guide to rainwater harvesting available in pdf...  
<http://www.waterwiser.org/template1cfm?page1=rain%20books%20&page2=books-menu%20>
16. Rainwater harvesting -for more information on rainwater harvesting and water efficient landscaping  
<http://www.southface.org/home/sfpubs/articles/rainwater.html>
17. Rainwater harvesting ...energy, conserve water, reduce erosion and storm water runoff and keep your landscape healthy and green consider an ancient technology.  
<http://www.southface.org/hame/sfpubs/sfvloo/rainwater.html>
18. Rainwater harvesting system - usda forest service, pacific southwest research station. Centre for urban forest research home.  
<http://www.wcufre.ucdams.edu/1slide%2011.html>.
19. Rainwater harvesting system, need of the hour, environment.  
<http://www.%20chennaionline.com/science/environment/%20rainwater%20.asp>
20. Rainwater harvesting oasis design water system consultancy  
[www.oasisdesign.net/rainwaterharvesting/rainwater.html](http://www.oasisdesign.net/rainwaterharvesting/rainwater.html)
21. The desert house: rainwater harvesting or collecting rainwater for future water needs, has been used for many centuries as a way to take advantage of seasonal participation.  
[www.dbg.org/center-de/rainwater-harwesting.html](http://www.dbg.org/center-de/rainwater-harwesting.html)

22. Sustainable earth technologies - rainwater harvesting.. what is rainwater harvesting and why is it important?  
what are the benefits in rainwater harvesting?  
[www.acay.com.am/~south/rainwater.html](http://www.acay.com.am/~south/rainwater.html)
23. Rainwater harvesting is also a part of our food production and shelter programmers in africa.....  
[http://www.itdg.org/htm/water\\_and\\_sanitation/xpertise3.htm](http://www.itdg.org/htm/water_and_sanitation/xpertise3.htm)
24. Barish rainwater  
<http://www.azadbarish.com/>
25. (pdf) water harvesting rainwater harvesting system is an alternative method that we can utilised to reduce our dependency on potable water. Rainwater harvesting system is not...  
<http://www.swfwmd.state.fl.us/watercon/files/water%20%%2020>
26. Rainwater harvesting system for increasing livestock for age on arid... range lands of pakistan.  
[www.uvalde.tamu.edu/jrm/nov95/suleman.htm](http://www.uvalde.tamu.edu/jrm/nov95/suleman.htm)
27. Rainwater club, bangalore  
<http://www.rainwaterclub.org/>
28. Rainwater harvesting-healthful investment for an ecological future  
[www.wildflower.org/grow\\_native/faq/rainwater\\_harvesting](http://www.wildflower.org/grow_native/faq/rainwater_harvesting)
29. Rooftop rainwater harvesting-irc home dgis policy supporting paper  
[www.irc.nl/themes/iwrm/pprainwater.html](http://www.irc.nl/themes/iwrm/pprainwater.html)
30. The web of rain  
[www.gdrc.org/uesn/water/rainwater/rain\\_web.html](http://www.gdrc.org/uesn/water/rainwater/rain_web.html)
31. Special focus: info rain sources  
[www.gdrc.org/uesn/water/rainwater](http://www.gdrc.org/uesn/water/rainwater)
32. Rainwater harvesting, landscape and hard surface  
[www.ag.arizona.edu/cochise/waterwise/rainwaterharvesting.html](http://www.ag.arizona.edu/cochise/waterwise/rainwaterharvesting.html)
33. Rainwater harvesting agriculture- an integrated system for water management in rainfed and in china's semi arid areas  
[http://www.ambio.kva.se/2000/nr8\\_00\\_3.html](http://www.ambio.kva.se/2000/nr8_00_3.html)
34. Rainwater harvesting climatic solutions  
<http://www.climatesolutions.org/>
35. The hindu rainwater harvesting-online edition of india's national newspaper  
<http://www.hinduonnet.com/the%20hindu/2001/07/23/stories>
36. City to unveil rainwater harvesting rebate programmes march 1998. us water news online.  
<http://www.uswaternews.com/archives/arconserve/8citunv3.htm>
37. Lanka rainwater harvesting forum  
<http://www.rainwaterharvesting.com/>
38. Rainwater harvesting: ways of raising public awareness for rainwater harvesting for artificial recharge  
<http://www.water-2001-de/datenbank/756523053.36977.9/ways%20%200f>
39. Somali land: cement lined tanks for rainwater harvesting. 21st wedc conference  
<http://www.anaserve.com/>
40. Contributions relating to rainwater harvesting- a new framework for decision making  
<http://www.damsreport.org/docs/kbasw/contrib/opt163.pdf>
41. Information on rainwater harvesting with an emphasis on roofwater harvesting  
[www.jiscmoril.ac.uk/files/rainwaterharvesting/rainwaterharvesting\\_resources.doc](http://www.jiscmoril.ac.uk/files/rainwaterharvesting/rainwaterharvesting_resources.doc)
42. Rainwater harvesting demonstration incentive programme  
[www.ci.austin.tx.us/watercon/rainbrochure.pdf](http://www.ci.austin.tx.us/watercon/rainbrochure.pdf)
43. Rainwater harvesting with multiple barrels  
<http://www.kidsfromkanata.org/>

44. Rainwater harvesting water system design service, system examples  
<http://www.rainwaterharvesting.net/>
45. Rainwater harvesting be a solution to drinking water problem in Bangladesh  
[www.eb2000.org/short\\_note\\_4.htm](http://www.eb2000.org/short_note_4.htm)
46. Rainwater harvesting the collection of rainfall and runoff in rural areas: arnold pacey, adrian cullis  
<http://www.styluspub.com/books/book3229.html>
47. Rainwater harvesting in situ: site preparation methods for rainwater harvesting in northeastern brazil  
<http://www.oas.org/usde/publications/unit/oea59e/ch11.htm>
48. Rainwater harvesting or collections: for centuries the world has relied upon rainwater harvesting to supply water for household, landscape and agricultural uses....  
<http://www.tnrce.state.tx.us/exec/sbea/rainwater/rainwater.htm>
49. Water magazine index- rainwater harvesting and collection-article links: examples of simple, low cost rainwater harvesting systems were seen over Yorkshire  
<http://www.watermagazine.com/>
50. Rainwater harvesting: A rainwater collection and storage system is investigated, focusing on water quality at various parts  
<http://www.uoregon.edu/~jcohen2/>
51. Rainwater harvesting over the last few years, Britain...  
[www.2.rgn.ac.uk/sub/searchin/research/materialconservation/wastewater/waha.htm](http://www.2.rgn.ac.uk/sub/searchin/research/materialconservation/wastewater/waha.htm)
52. Rainwater harvesting in Bangladesh  
<http://www.bien.com/acic/resources/infobank/deh98-12conf/paper3-1.htm>
53. Hindustan times  
[www.thehindustantimes.com/nonfram/070901/detc1t16.asp](http://www.thehindustantimes.com/nonfram/070901/detc1t16.asp)
54. Construction of underground rainwater harvesting tanks  
<http://www.enrap.org/partness/srilanka2/rainwater%20harvestingmanual.htm>
55. Kaaraka, v. 1996, Management of bushland vegetation using rainwater harvesting in eastern Kenya.  
<http://www.metla.f:julkaisut/acta/abs/aa253.htm>
56. Water conservation-prevents soil erosion and flooding especially in urban areas  
<http://www.edugreen.teri.res.in/explore/water/conser.htm>
57. Rainwater harvesting water softness and reverse osmosis-complete rainwater harvesting systems  
<http://www.texasmetalasterms.com/services.htm>
58. Rainwater harvesting guide...  
[www.csf.colorado.edu/archive/2000/permaculture/msg02188.html](http://www.csf.colorado.edu/archive/2000/permaculture/msg02188.html)
59. Potential for rainwater harvesting in bangladesh  
[www.phys4.harvard.edu/~wilson/arsenic-project-paper3-1.htm](http://www.phys4.harvard.edu/~wilson/arsenic-project-paper3-1.htm)
60. Alternative concept  
[www.pastornet.net.au/worldnews/ac.htm](http://www.pastornet.net.au/worldnews/ac.htm)
61. Rainwater harvesting type book description: This book shows ancient and modern designs for drinking water systems, tanks and cisterns...  
<http://www.gaia.org.services/article/water/detail-140.asp>
62. Untitled- can rainwater harvesting be a solution...  
<http://www.dainichi.consul.co.jp/english/arsenic/article/rain-water.htm>
63. Rainwater harvesting in the developing world....  
[www.esr.org.nz/events/even2000/rainwater.html](http://www.esr.org.nz/events/even2000/rainwater.html)
64. FAKT field of work introduction: Water supply  
[www.fakt-consult.de/sector/2was.htm](http://www.fakt-consult.de/sector/2was.htm)



65. Texas water- water facts-....  
[www.tpoood.state.tx.us/texaswater/sb1/primer/primer1/oof-rain-waterharvesting.htm](http://www.tpoood.state.tx.us/texaswater/sb1/primer/primer1/oof-rain-waterharvesting.htm)
66. Source book of alternative technologies for freshwater..  
[www.unep.or.jp/ietc/publications/techpublications/techpub-se](http://www.unep.or.jp/ietc/publications/techpublications/techpub-se)
67. Rainwater harvesting in tamil nadu...  
<http://www.sciseek.com/dir/environment/water-resources/rainwater-hav/index.shtml>
68. Preliminary study of rainwater harvesting in mid west uganda...  
[www.eng.warcrick.ac.uk.dtu/pubs/up/up45/001cov.html](http://www.eng.warcrick.ac.uk.dtu/pubs/up/up45/001cov.html)
69. Duryog nivaran : publications...  
[www.adpc.ait.ac.th/duryog/publications](http://www.adpc.ait.ac.th/duryog/publications)
70. Rainwater harvesting - media. to tackle the problem of drought...  
[www.teriin.org/energy/waterhar.htm](http://www.teriin.org/energy/waterhar.htm)
71. Rainwater harvesting is decentralised...  
[www.verhnizen-ww.com/html/wh.html](http://www.verhnizen-ww.com/html/wh.html)
72. International center for integrated mountain development, Rainwater harvesting system - key solution to a looming crisis  
<http://www.%20icimod.org.sg/publications/newsletter/news%2036/rain.htm>
73. Information on the history of water harvesting methodologies in tamilnadu and the modern methods adopted for rainwater harvesting structures and advised by TWAD Board for both the individuals & professionals.  
<http://www.aboutrainwaterharvesting.com/>
74. Drip irrigation system. Rainwater harvesting: a new water source by Jan ... popularity in a new way. Rainwater harvesting is enjoying a renaissance ... biblical times. Extensive rainwater harvesting apparatus existed 4000 years ...  
<http://twri.tamu.edu/twripubs/WtrSavrs/v3n2/article-1.html>
75. Has the mandate for the "Regulation and Control of Ground Water Development and Management" in the country...  
<http://www.cgwaindia.com/>
76. A beautiful example on rainwater harvesting done by Mr. Krishna, an Oregon resident. Portland receives 4 feet of rainfall annually. His 1200 squarefeet house captures on average 3600 cubit...  
<http://www.rdrop.com/users/krishna/rainwatr.htm>
77. Rainwater harvesting the rainwater harvesting system at casa del agua channels rainfall for ... evaporative cooler. Elements of Casa's Rooftop Rainwater Harvesting Rooftop Catchment Size  
<http://ag.arizona.edu/OALS/oals/dru/waterharvesting.html>
78. Rainwater harvesting in honduras technical description the harvesting of water ... bibliography schiller, ej, and bg latham. 1995. Rainwater harvesting systems. Santiago, chile, paho/cepis. This page last updated  
[http://www.oas.org/SP/PROG/chap5\\_1.htm](http://www.oas.org/SP/PROG/chap5_1.htm)
79. Rainwater harvesting, or collecting rainwater for ... use on their farms and ranches. Rainwater harvesting is a major source of drinking ... The second component of rainwater harvesting at desert house uses the roof  
[http://www.dbg.org/center\\_dl/rainwater\\_harvesting.html](http://www.dbg.org/center_dl/rainwater_harvesting.html)
80. Texas guide to rainwater harvesting texas guide to ... second edition texas guide to rainwater harvesting second edition acknowledgments ... acknowledgments the texas guide to rainwater harvesting was developed by the center [link will download it in pdf format.]  
<http://www.twdb.state.tx.us/publications/.../RainHarv.pdf>
81. You are here: Home > rainwater harvesting rainwater harvesting ... ferrocement rainwater harvesting cistern  
<http://www.rainwaterharvesting.net/>
82. Systems ltd is the uk leader in rainwater harvesting systems ... market leading supplier for rainwater harvesting filters. We have designed rainwater harvesting systems for all types of...  
<http://www.rainharvesting.co.uk/>



# Glossary

**Air gap:** A vertical space between a water or drain line and the flood level of a receptacle used to prevent backflow or siphonage from the receptacle in the event of negative pressure or vacuum.

**Aquifer:** A porous geological formation which can store an appreciable amount of ground water and from which water can be extracted in useful quantities.

**Artificial recharge:** Any man made scheme or facility that adds water to an aquifer is artificial recharge system.

**Backflow preventer:** A device or system installed in a water line to stop backflow from a nonpotable source.

**Backflow:** Flow of water in a pipe or water line in a direction opposite to normal flow.

**Backwater:** The wastewater from toilets and kitchen sinks.

**Bore well:** Small diameter wells, which are generally deeper than open wells.

**Buffer:** To shift pH to a specific value.

**Building footprint:** The area of a building on the ground.

**Catchment Area:** The area from which runoff flows into a river, reservoir, etc.

**Check Dam:** Small dam constructed in a gully or other small watercourse to decrease the stream flow velocity, minimize channel scour and promote deposition of sediment.

**Chlorination:** The use of chlorine for the treatment of water, sewage or industrial wastes for disinfection or oxidation.

**Cistern:** An above or below ground tank used to store water, generally made of galvanized metal, fiberglass, ferrocement or concrete.

**Contamination:** To introduce a substance that would cause the concentration of that substance to exceed the maximum contaminant level and make the water unsuitable for its intended use.

**Disinfection:** A process in which pathogenic (disease producing) bacteria are killed by use of chlorine or physical processes.

**Diverter:** A mechanism designed to divert the first flush rainwater from entering the cistern.

**Dug wells:** Traditionally used large diameter wells. Defined precisely as pits excavated in the ground until the water table is reached, supported on the sides by RCC/Bricks/Stones/Walls, Diameters could vary from 0.6 metres onwards.

**Erosion:** The loss of topsoil that occurs as a result of run-off.

**Filtration:** The process of separating particles of 2 microns or larger in diameter from water by means of a porous substance such as a permeable fabric or layers of inert material housed in a media filter or removable cartridge filter.

**First flush:** Generally the first 50 litres of rainwater per 1,000 square feet of roof surface that is diverted due to potential for contamination.

**Flow rate:** The quantity of water which passes a given point in a specified unit of time, expressed in litres per minute.

**Force breaker:** An extension of the fill pipe to a point 1" above the bottom of the cistern, which dissipates the pressure of incoming rainwater and thus minimizes the stirring of settled solids.

**Greywater:** The wastewater from residential appliances or fixtures except toilets and kitchen sinks.

**Ground Water Draft:** It is the quantity of Ground Water withdrawn from Ground Water Reservoirs.

**Ground Water:** The water retained in the intergranular pores of soil or fissures of rock below the water table is called ground water.

**Hardness:** A characteristic of ground water due to the presence of dissolved calcium and magnesium, which is responsible for most scale formation in pipes and water heaters.

**Hydrologic cycle:** The continual exchange of water from the atmosphere to the land and oceans and back again.

**Katchi Abadis:** Settlements/living colonies where people live in not so durable houses/shelters which may be made of mud, thatch, wood etc. or other non durable materials.

**Leaf screen:** A mesh installed over gutters and entry points to downspouts to prevent leaves and other debris from clogging the flow of rainwater.

**Masonry:** A wall or other structures made using building blocks like bricks or stone with binding materials like cement or lime.

**Micron:** A linear measure equal to one millionth of a meter, or .00003937 inch.

**Nonpotable water:** Water intended for non-human consumption purposes, such as irrigation, toilet flushing, and dishwashing.

**Open Wells:** Same as dug well. These wells were kept open in earlier days for manual withdrawal of water. Today, with electrical or diesel/patrol pumps, these can be fully covered.

**Pathogen:** An organism which may cause disease.

**pH:** A logarithmic scale of values of 0 to 14 that measure of hydrogen ion concentration in water which determines whether the water is neutral (pH 7), acidic (pH 0-7) or basic (pH 7-14).

**Potable water:** Water which is suitable and safe for human consumption.

**Pressure tank:** A component of a plumbing system that provides the constant level of water pressure necessary for the proper operation of plumbing fixtures and appliances.

**Rainwater harvesting:** The principle of collecting and using precipitation from a catchment surface.

**Recharge:** The process of surface water (from rain or reservoirs) joining the ground water aquifer.

**Replenishable Ground Water:** It is the portion of precipitation which after infiltration percolates down and joins the ground water reservoir.

**Reservoir:** A pond or lake built for the storage of water, usually by the construction of dam across a river.

**Roof washer:** A device used to divert the first flush rainwater from entering a cistern.

**Runoff:** Runoff is the term applied to the water that flows away from a surface after falling on the surface in the form of rain.

**Sedimentation:** The process in which solid suspended particles settle out (sink to the bottom) of water, frequently after the particles have coagulated.

**Total dissolved solids:** A measure of the mineral content of water supplies.

**Water Pollution:** The addition of harmful or objectionable material causing an alteration of water quality.

**Water Quality:** A graded value of the components which comprise the nature of water. Established criteria determine the upper and/or lower limits of those values which are suitable for particular uses (organic, inorganic, chemical, physical).

**Water Table:** The level of water within its granular pores of soil or fissures of rock, below which the pores of the host are saturated.

**Wetlands:** Areas of marsh, fen, peatlands or water, natural or artificial, permanent or temporary, with water that is static or flowing, fresh, brackish or salt including areas of marine water less than six metres deep at low tide.

# Rainwater Harvesting FAQs

## 1. What is Roof Top Harvesting?

To collect and store the rainwater which falls on the terrace of the buildings/houses. The water collected from the terrace is of good quality and it can be stored in tanks/sumps either for direct use or can be diverted to the existing bore well/open well for ground water recharge and storage.

## 2. What are the precautions to be taken for roof top harvesting?

The terrace of the building should be maintained clean. A grill/mesh has to be fixed at the entrance of the rainwater pipe in the terrace to arrest large particles such as papers, leaves, etc. A filter chamber has to be provided to filter small/minute dust particles before diverting the rainwater into the storage tank or open well/bore well.

## 3. How to harvest rainwater in the open spaces?

Rainwater collected in the open spaces, being relatively dirty in nature, cannot be used for direct recharge of the well and therefore used for ground water recharge, using appropriate recharge methods/structures. In the absence of open well, the roof-top water may also be harvested along with open space water.

## 4. What are the precautions to be taken while harvesting rainwater from open space around the building?

A dwarf wall of (7.5 cm height) has to be constructed at the entrance/gate to avoid run off into the street/road. If man holes are present (sewerage/waste water line) the height has to be raised a little to avoid draining of rainwater through the manholes.

## 5. What are the RWH methods used for ground water recharge?

There are various methods available for rainwater recharge into the ground which depend on the nature of sub-surface formation, extent of the area from where rainwater is collected. Some of the simple and cost effective RWH structure methods are:

- ❖ Percolation Pit
- ❖ Percolation Pit with Bore
- ❖ Recharge Trench
- ❖ Recharge Trench with Bore
- ❖ Recharge well (shallow/small)
- ❖ Recharge well (deep/large)

## 6. What are the methods suitable for sandy sub-soil area?

As the sandy soil facilitates easy percolation of rainwater, shallow recharge structures such as percolation pits, recharge trenches and shallow/small recharge wells are enough for sandy sub-soil areas.



**7. What are the methods suitable for areas with clay sub-soil and hard rock areas?**

Since clay sub-soil formation is impervious in nature and is having poor permeability, deep recharge structures such as percolation pit with bore, recharge trench with bore and deep/large recharge wells are needed for deep percolation into the underlying sandy layer.

For hard rock areas it is advisable to construct recharge wells the size of which depend on the extent of the area/building.

**8. Can existing structures be used for RWH?**

Yes. Existing structures such as defunct bore wells, unused/dried up open wells, unused sump, etc. can be very well used for RWH instead of constructing recharge structures to reduce the total cost.

**9. Does RWH help to get immediate benefits?**

Yes. In case of roof top rainwater harvesting where the water is collected in storage tanks/sumps after filtering, the water is available for use the moment it rains.

In case of ground water recharge where the quality of ground water is poor or moderate considerable improvement in quality would be observed from three to five years, if continuous recharge of rainwater is effected into an open well. However, slight improvement can be seen within weeks of rain if RWH structures have been installed. As far as improvement in ground water table is concerned, the improvement can be seen even during one rain fall season if large number of people have done RWH in a locality. In short, rainwater is relatively pure form of water and when it is added to the relatively poor quality of ground water, the quality of that water will improve due to dilution. More the water harvested better will be the result.

**10. Is it necessary to construct all types of recharge structures in buildings?**

Not necessary. In areas with alluvial sand, recharge structures would not be required unless the open spaces are covered with cement pavements. In other areas depending upon the area one or two recharge structures are enough to meet the requirement of an average sized house. Preference must be given to roof-top harvesting using existing open well. When roof-top harvesting using sumps and existing sumps and open well is practiced, it would take care of 60 to 75 percent of the rainwater recharge in an ordinary/normal house. In such cases, one or two simple structures would suffice to harvest the rainwater from the remaining open spaces around the building.

**11. Is roof top water suitable for drinking and cooking?**

Though the rainwater which falls on roof is pure but, still when it falls on roof and on the way to sump, some dirt, dust particles etc. are carried away with it. Therefore, it is advisable to filter this water and boil it before using for cooking and drinking.

**12. What kind of catchment surfaces are most efficient?**

The effective catchment area and the material used in constructing the catchment surface influence the collection efficiency and water quality. Materials commonly used for roof catchment are corrugated aluminium and galvanized iron, concrete, fibreglass shingles, tiles, slates, etc. Mud is used primarily in rural areas. Bamboo roofs are least suitable because of possible health hazards. The materials of catchment surfaces must be non-toxic and should not contain substances which impair water quality. For example, asbestos roofs should be avoided; also, painting or coating of catchment surfaces should be avoided if possible. If the use of paint or coating is unavoidable, only non-toxic paint or coating should be used; lead, chromium, and zinc-based paints/coatings should be avoided. Similarly, roofs with metallic paint or other coatings are not recommended as they may impart tastes or colour to the collected water. Catchment surfaces and collection devices should be cleaned regularly to remove dust, leaves and bird droppings so as to minimize bacterial contamination and maintain the quality of collected water. Roofs should also be free from over-hanging trees since birds and animals in the trees may defecate on the roof.

**13. How can the runoff capacity be increased?**

When land surfaces are used as catchment areas, various techniques are available to increase runoff capacity, including: i) clearing or altering vegetation cover, ii) increasing the land slope with artificial ground cover, and iii) reducing soil permeability by soil compaction. Specially constructed ground surfaces (concrete, paving stones, or some kind of liner) or paved runways can also be used to collect and convey rainwater to storage tanks or reservoirs. In the case of land surface catchments, care is required to avoid damage and contamination by people and animals. If required, these surfaces should be fenced to prevent the entry of people and animals. Large cracks in the paved catchment due to soil movement, earthquakes or exposure to the elements should be repaired immediately. Maintenance typically consists of the removal of dirt, leaves and other accumulated materials. Such cleaning should take place annually before the start of the major rainfall season.





For more information contact:

United Nations Human Settlements Programme (UN-HABITAT)  
Water, Sanitation and Infrastructure Branch  
P.O. Box. 30030, Nairobi, Kenya; Tel: +254-20-623039; Fax: +254-20-623588  
Email: [Kalyan.Ray@unhabitat.org](mailto:Kalyan.Ray@unhabitat.org); Website: [www.unhabitat.org](http://www.unhabitat.org)