

Compendium of Sanitation Systems and Technologies

2nd
revised
edition

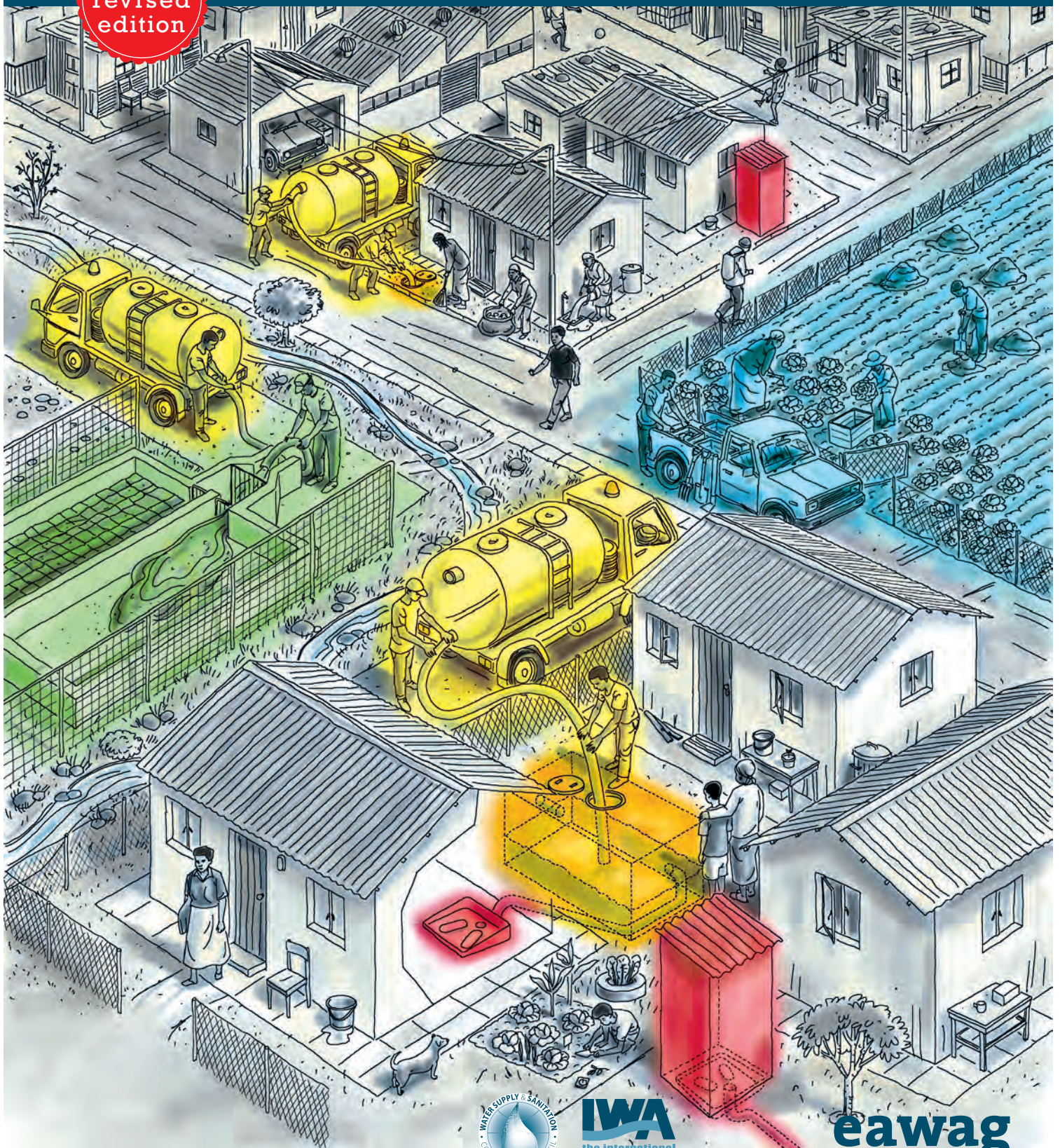

Compendium of Sanitation Systems and Technologies

2nd revised edition

**Elizabeth Tilley, Lukas Ulrich, Christoph Lüthi,
Philippe Reymond, Roland Schertenleib and Christian Zurbrügg**

Our special thanks go to:
the Sustainable Sanitation Alliance (SuSanA)
and the International Water Association (IWA) specialist groups.

We would like to thank the following individuals
for their contributions and comments:
Magalie Bassan, Chris Canaday, Pierre-Henri Dodane, Jan-Olof Drangert,
Andrin Fink, Roman Grüter, Heino Güllemann, Heike Hoffmann,
Elisabeth Kvarnström, Christian Riu Lohri, Antoine Morel, Peter Morgan,
Eberhard Morgenroth, Elisabeth von Münch, Sara Oppenheimer, Jonathan Parkinson,
Eddy Perez, Annette Remmele, Samuel Renggli, Christian Rieck, David Robbins,
Anjali Sherpa, Mingma Sherpa, Hansruedi Siegrist, Dorothee Spuhler,
Linda Strande, Gabor Szanto, Kai Udert, Björn Vinnerås,
Carolien van der Voorden, Nancho Zimmermann

We would like to acknowledge support from:
The Swiss Agency for Development and Cooperation (SDC)
The Water Supply & Sanitation Collaborative Council (WSSCC)

 Schweizerische Eidgenossenschaft
Confédération suisse
Confederazione Svizzera
Confederaziun svizra

Swiss Agency for Development
and Cooperation SDC





Christian Zurbrugg
Eawag



Chris Williams
WSSCC



Jonathan Parkinson
IWA

Undisputedly, sanitation is a key element of sustainable development and significantly influences people's health and wellbeing worldwide. The International Water Association (IWA), the Water Supply and Sanitation Collaborative Council (WSSCC) and Eawag have made considerable efforts to promote improved sanitation by providing an easily accessible knowledge base and guidance about how to achieve these improvements. Working collaboratively under the Urban Sanitation Initiative, we continue to foster innovation, disseminating information about the full range of sanitation technologies and building the capacity of practitioners who use this information.

The first Compendium produced by Eawag (Department Sandec) and WSSCC in 2008 went a long way towards this objective. It provides knowledge on a wide range of sanitation technologies without bias and/or agenda, and helped to increase the recognition that a fully functioning sanitation 'chain' must link toilets to a treatment facility via an operational collection and transportation system. It also presented resource recovery and reuse options as a necessary objective for the sustainable management of excreta.

In recent years, the Compendium has become the most popular technical compilation in the sanitation sector and is widely acclaimed by a large audience as an international reference tool. This expanded second edition provides updates and presents information about an increased range of technologies and will be an important resource for stakeholders in their decision making planning process. The eCompendium version allows for improved on-line access to the information and flexibility of use, and makes updating easier.

We believe that our on-going collective efforts will help to ensure the achievement of the Sustainable Development Goals regarding sanitation and also those relating to health, water and environmental sustainability.

Table of Contents

Introduction	7
Background and Target Audience	7
What's New in the Second Edition?	7
Structure and Use of the Compendium	7
Complementary Sanitation Sector Development Tools	8
Compendium Terminology	10
Sanitation Systems	10
Products	10
Functional Groups	12
Sanitation Technologies	13
Part 1: System Templates	15
Using the System Templates	16
System 1: Single Pit System	20
System 2: Waterless Pit System without Sludge Production	22
System 3: Pour Flush Pit System without Sludge Production	24
System 4: Waterless System with Urine Diversion	26
System 5: Biogas System	28
System 6: Blackwater Treatment System with Infiltration	30
System 7: Blackwater Treatment System with Effluent Transport	32
System 8: Blackwater Transport to (Semi-) Centralized Treatment System	34
System 9: Sewerage System with Urine Diversion	36
Part 2: Functional Groups with Technology Information Sheets	39
Reading the Technology Information Sheets	40
U User Interface	42
U.1 Dry Toilet	44
U.2 Urine-Diverting Dry Toilet (UDDT)	46
U.3 Urinal	48
U.4 Pour Flush Toilet	50
U.5 Cistern Flush Toilet	52
U.6 Urine-Diverting Flush Toilet (UDFT)	54
S Collection and Storage/Treatment	56
S.1 Urine Storage Tank/Container	58
S.2 Single Pit	60
S.3 Single Ventilated Improved Pit (VIP)	62

S.4 Double Ventilated Improved Pit (VIP)	64
S.5 Fossa Alterna	66
S.6 Twin Pits for Pour Flush	68
S.7 Dehydration Vaults	70
S.8 Composting Chamber	72
S.9 Septic Tank	74
S.10 Anaerobic Baffled Reactor (ABR)	76
S.11 Anaerobic Filter	78
S.12 Biogas Reactor	80
C Conveyance	82
C.1 Jerrycan/Tank	84
C.2 Human-Powered Emptying and Transport	86
C.3 Motorized Emptying and Transport	88
C.4 Simplified Sewer	90
C.5 Solids-Free Sewer	92
C.6 Conventional Gravity Sewer	94
C.7 Transfer Station (Underground Holding Tank)	96
T (Semi-) Centralized Treatment	98
PRE Pre-Treatment Technologies	100
T.1 Settler	102
T.2 Imhoff Tank	104
T.3 Anaerobic Baffled Reactor (ABR)	106
T.4 Anaerobic Filter	108
T.5 Waste Stabilization Ponds (WSP)	110
T.6 Aerated Pond	112
T.7 Free-Water Surface Constructed Wetland	114
T.8 Horizontal Subsurface Flow Constructed Wetland	116
T.9 Vertical Flow Constructed Wetland	118
T.10 Trickling Filter	120
T.11 Upflow Anaerobic Sludge Blanket Reactor (UASB)	122
T.12 Activated Sludge	124
T.13 Sedimentation/Thickening Ponds	126
T.14 Unplanted Drying Beds	128
T.15 Planted Drying Beds	130
T.16 Co-Composting	132
T.17 Biogas Reactor	134
POST Tertiary Filtration and Disinfection	136
D Use and/or Disposal	138
D.1 Fill and Cover/Arborloo	140
D.2 Application of Stored Urine	142
D.3 Application of Dehydrated Faeces	144

D.4 Application of Pit Humus and Compost	146
D.5 Application of Sludge	148
D.6 Irrigation	150
D.7 Soak Pit	152
D.8 Leach Field	154
D.9 Fish Pond	156
D.10 Floating Plant Pond	158
D.11 Water Disposal/Groundwater Recharge	160
D.12 Surface Disposal and Storage	162
D.13 Biogas Combustion	164
Emerging Sanitation Technologies	166
Glossary	170

Background and Target Audience

The Compendium of Sanitation Systems and Technologies was first published in 2008 during the International Year of Sanitation. Since then it has been translated into several languages and distributed digitally by various sector organizations. The document's popularity lies in its brevity – structuring and presenting a huge range of information on tried and tested technologies in a single document. As in the first edition, we do not consider sanitation technologies that are under development or that exist only as prototypes. Also, we only include “improved” sanitation technologies that provide safe, hygienic, and accessible sanitation. Like the first edition, we include the whole range of urban, peri-urban and rural technologies (e.g., from single pits to conventional sewers).

The Compendium is a guidance document for engineers and planners in low- and middle-income countries, primarily intended to be used for communicative planning processes involving local communities. It is also intended for persons/experts who have detailed knowledge about conventional high-end technologies and require information on infrastructure and different system configurations. It is not intended as a stand-alone document for engineers, making decisions *for* the community, e.g., expert-driven decision-making.

What's New in the Second Edition?

The revised, second edition has more content, and offers:

1. Simplified user guidance
2. Revised technology descriptions with updated references and improved illustrations based on reviews by renowned sector experts and taking into account key developments in the sector over the last six years
3. A more elaborate presentation of input and output products that clarifies the compatibility between technologies and streamlines system configuration
4. Five new technology information sheets and a section on emerging technologies
5. An additional sanitation system, “System 5: Biogas System”

Structure and Use of the Compendium

Like the first edition, the Compendium is divided into two parts: (1) the **System Templates** and a description about how to use them; and (2) the **Technology Information Sheets**.

It is recommended that the Compendium user first review the sections “Compendium Terminology” (pp. 10-13) and “Using the System Templates” (pp. 16-19), to become familiar with the key terms and structure of the system templates and their components. Thereafter, the user can move between the system templates and technology information sheets (they are cross-referenced) until he/she has identified systems and/or technologies appropriate for further investigation. Eventually, the user should be able to develop one or several system configurations to present to the community of the intervention area. Following the community's suggestions, the Compendium can then be used to re-evaluate and redesign the systems accordingly.

The Compendium is only one document in the field to facilitate informed decision-making on the part of different stakeholders involved in improving environmental sanitation services, and should be used in conjunction with other available publications and tools. An overview of complementary sanitation sector development tools is provided on the following double page.

Complementary Sanitation Sector Development Tools

In the past few years, a number of documents have been published that complement this work and add to the growing body of sustainable technology reference materials and practical guides. Some are presented below:



Community-Led Urban Environmental Sanitation : CLUES Complete Guidelines for Decision Makers with 30 Tools

CLUES presents a complete set of guidelines for sanitation planning in low-income urban areas. It is the most up-to-date planning framework for facilitating the delivery of environmental sanitation services for urban and peri-urban communities. CLUES features seven easy-to-follow steps, which are intended to be undertaken in sequential order. Step 5 of the planning approach relies on the Compendium, applying the systems approach to select the most appropriate technological option(s) for a given urban context. The document also provides guidance on how to foster an enabling environment for sanitation planning in urban settings.

By Lüthi, C., Morel, A., Tilley, E. and Ulrich, L. (2011). Eawag (Sandec), WSSCC, UN-HABITAT. Free PDF available at: www.sandec.ch/clues

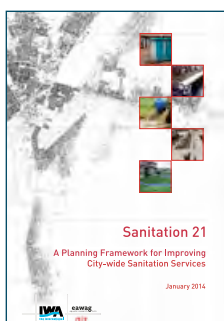

Sanitation 21

A Planning Framework for Improving City-wide Sanitation Services

Sanitation 21 presents an internationally recognized planning framework based upon key principles of sanitation planning and recommended process guidelines. Built upon practical experience and best practices, Sanitation 21 brings together decisions about technology and management options with stakeholder needs and preferences to help inform the choice of appropriate sanitation systems. It is written in non-technical language to be relevant to policy makers and practitioners who are interested in providing appropriate and affordable sanitation services and presents recommended activities to guide the development of a city sanitation plan. This revised version of the Sanitation 21 framework builds upon the increase in knowledge and experience in city-wide planning.

By Parkinson, J., Lüthi, C. and Walther, D. (2014). IWA, GIZ, Eawag (Sandec).

Free PDF available at: www.iwahq.org and www.sandec.ch

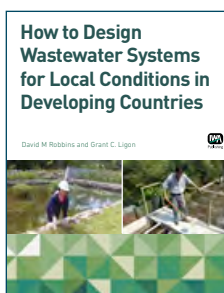

How to Design Wastewater Systems for Local Conditions in Developing Countries

This manual provides guidance in the design of wastewater systems in developing country settings. It promotes a context-specific approach to technology selection by guiding the user to select the most suitable technologies for their area. It provides tools and field guides for source characterization and site evaluation, as well as technology identification and selection. This manual is primarily addressed to private and public sector service providers, regulators and engineers/development specialists in charge of implementing wastewater systems.

By Robbins, D. M. and Ligon, G. C. (2014). IWA Publishing.



Faecal Sludge Management **Systems Approach for Implementation and Operation**

This is the first book to compile the current state of knowledge on faecal sludge management. It addresses the organization of the entire faecal sludge management service chain, from the collection and transport of sludge, to the current state of knowledge of treatment options, and the final end use or disposal of treated sludge. It presents an integrated approach that brings together technology, management, and planning, based on Sandec's 20 years of experience in the field. It also discusses important factors to consider when evaluating and upscaling new treatment technology options. The book is designed for undergraduate and graduate students, engineers, and practitioners in the field who have some basic knowledge of environmental and/or wastewater engineering.

*By Strande, L., Ronteltap, M. and Brdjanovic, D. (Eds.) (2014). IWA Publishing.
Free PDF available at: www.sandec.ch*

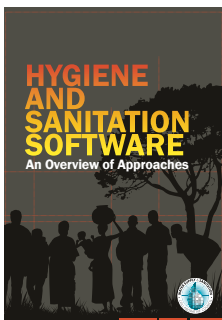

Hygiene and Sanitation Software – An Overview of Approaches

In sanitation and hygiene programme and service delivery, several methods are used to engage target groups in development programmes to enable behavioural change and/or create a demand for services. These methods or approaches are generally referred to as 'software', to distinguish them from the provision of 'hardware'. This publication takes an in-depth look at the various hygiene and sanitation software approaches that have been deployed over the last 40 years in all types of settings – urban, informal-urban and rural, and aims to address such issues as what a particular approach is designed to achieve, what it actually comprises, when and where it should be used, how it should be implemented and how much it costs, etc. This publication was developed as a companion to the Compendium.

*By Peal, A., Evans, B. and van der Voorden, C. (2010). WSSCC.
Free PDF available at: www.wsscc.org*

*Additional
on-line resources*



The following on-line tools provide useful guidance and downloadable resources that complement the documents listed above.

eCompendium

The digital version of the Compendium is a stand-alone digital resource, structured around the different sanitation systems and the 57 featured technologies. This electronic version allows for easier updating and flexibility of use on the part of different user groups. Additionally, it is an integral part of the SSWM Toolbox.

Available at: www.sandec.ch/ecompendium



Sustainable Sanitation and Water Management Toolbox

The SSWM Toolbox is the most comprehensive collection of tools and approaches of water management and sustainable sanitation available. It combines planning tools and software, and links them with publications, articles and web links, case studies, and training material.

Available at: www.sswm.info

Sanitation Systems

The Compendium defines sanitation as a multi-step process in which human excreta and wastewater are managed from the point of generation to the point of use or ultimate disposal. A **Sanitation System** is a context-specific series of technologies and services for the management of these wastes (or resources), i.e., for their collection, containment, transport, transformation, utilization or disposal. A sanitation system is comprised of **Products** (wastes) that travel through **Functional Groups** which contain **Technologies** that can be selected according to the context. **By selecting a Technology for each Product from each applicable Functional Group, one can design a logical Sanitation System.** A sanitation system also includes the management, operation and maintenance (O&M) required to ensure that the system functions safely and sustainably.

A **System Template** defines a suite of compatible technology combinations from which a system can be designed. In Part 1 of the Compendium, nine different sanitation system templates are described. A detailed explanation of how system templates function and how they are used is given in the section “Using the System Templates” on pp. 16-19.

Products

Products are materials that are also called ‘wastes’ or ‘resources’. Some products are generated directly by humans (e.g., Urine and Faeces), others are required in the functioning of technologies (e.g., Flushwater to move Excreta through sewers) and some are generated as a function of storage or treatment (e.g., Sludge).

For the design of a robust sanitation system, it is necessary to define all of the products that are flowing into (inputs) and out of (outputs) each of the sanitation technologies in the system. The products referenced within this text are described below.

Anal Cleansing Water is water used to cleanse oneself after defecating and/or urinating; it is generated by those who use water, rather than dry material, for anal cleansing. The volume of water used per cleaning typically ranges from 0.5 L to 3 L.

Biogas is the common name for the mixture of gases released from anaerobic digestion. Biogas is comprised of methane (50 to 75%), carbon dioxide (25 to 50%) and varying quantities of nitrogen, hydrogen sulphide, water vapour and other components. Biogas can be collected and burned for fuel (like propane).

Biomass refers to plants or animals cultivated using the water and/or nutrients flowing through a sanitation system. The term Biomass may include fish, insects, vegetables, fruit, forage or other beneficial crops that can be utilized for food, feed, fibre and fuel production.

Blackwater is the mixture of Urine, Faeces and Flushwater along with Anal Cleansing Water (if water is used for cleansing) and/or Dry Cleansing Materials (see Figure 1). Blackwater contains the pathogens of Faeces and the nutrients of Urine that are diluted in the Flushwater.

Brownwater is the mixture of Faeces and Flushwater, and does not contain Urine. It is generated by Urine-Diverting Flush Toilets (U.6) and, therefore, the volume depends on the volume of the Flushwater used. The pathogen and nutrient load of Faeces is not reduced, only diluted by the Flushwater. Brownwater may also include Anal Cleansing Water (if water is used for cleansing) and/or Dry Cleansing Materials (see Figure 1).

Compost is decomposed organic matter that results from a controlled aerobic degradation process. In this biological process, microorganisms (mainly bacteria and fungi) decompose the biodegradable waste components and produce an earth-like, odourless, brown/black material. Compost has excellent soil-conditioning

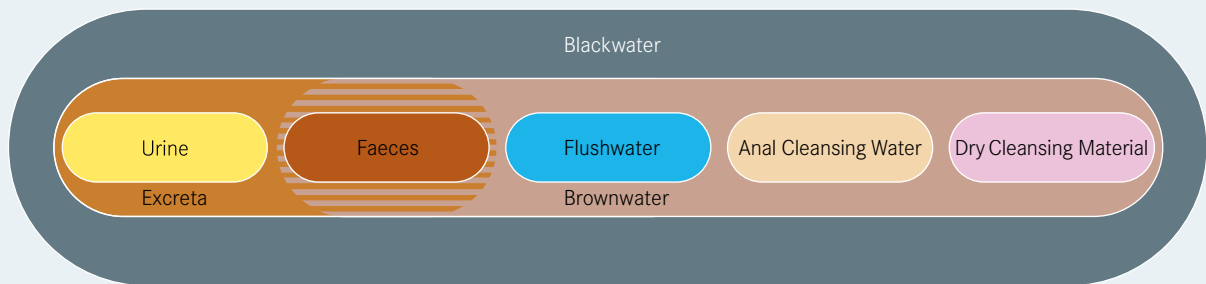

Figure 1: Definition of Excreta, Brownwater and Blackwater

properties and a variable nutrient content. Because of leaching and volatilization, some of the nutrients may be lost, but the material is still rich in nutrients and organic matter. Generally, Excreta or Sludge should be composted long enough (2 to 4 months) under thermophilic conditions (55 to 60 °C) in order to be sanitized sufficiently for safe agricultural use. This temperature is not guaranteed in most Composting Chambers (S.8), but considerable pathogen reduction can normally be achieved.

Dried Faeces are Faeces that have been dehydrated until they become a dry, crumbly material. Dehydration takes place by storing Faeces in a dry environment with good ventilation, high temperatures and/or the presence of absorbent material. Very little degradation occurs during dehydration and this means that the Dried Faeces are still rich in organic matter. However, Faeces reduce by around 75% in volume during dehydration and most pathogens die off. There is a small risk that some pathogenic organisms can be reactivated under the right conditions, particularly, in humid environments.

Dry Cleansing Materials are solid materials used to cleanse oneself after defecating and/or urinating (e.g., paper, leaves, corncobs, rags or stones). Depending on the system, Dry Cleansing Materials may be collected and separately disposed of. Although extremely important, a separate product name for menstrual hygiene products like sanitary napkins and tampons is not included in this Compendium. In general (though not always), they should be treated along with the solid waste generated in the household.

Effluent is the general term for a liquid that leaves a technology, typically after Blackwater or Sludge has undergone solids separation or some other type of treatment. Effluent originates at either a Collection and Storage or a (Semi-) Centralized Treatment technology. Depending on the type of treatment, the Effluent may be completely sanitized or may require further treatment before it can be used or disposed of.

Excreta consists of Urine and Faeces that is not mixed with any Flushwater. Excreta is small in volume, but concentrated in both nutrients and pathogens. Depending on the quality of the Faeces, it has a soft or runny consistency.

Faeces refers to (semi-solid) excrement that is not mixed with Urine or water. Depending on diet, each person produces approximately 50 L per year of faecal matter. Fresh faeces contain about 80% water. Of the total nutrients excreted, Faeces contain about 12% N, 39% P, 26% K and have 10^7 to 10^9 faecal coliforms in 100 mL.

Flushwater is the water discharged into the User Interface to transport the content and/or clean it. Freshwater, rainwater, recycled Greywater, or any combination of the three can be used as a Flushwater source.

Greywater is the total volume of water generated from washing food, clothes and dishware, as well as from bathing, but not from toilets. It may contain traces of Excreta (e.g., from washing diapers) and, therefore, also pathogens. Greywater accounts for approximately 65% of the wastewater produced in households with flush toilets.

Organics refers to biodegradable plant material (organic waste) that must be added to some technologies in order for them to function properly (e.g., Composting Chambers, S.8). Organic degradable material can include, but is not limited to, leaves, grass and market waste. Although other products in this Compendium contain organic matter, the term Organics refers to undigested plant material.

Pit Humus is the term used to describe the nutrient-rich, hygienically improved, humic material that is generated in double pit technologies (S.4-S.6) through dewatering and degradation. This earth-like product is also referred to as *EcoHumus*, a term conceived by Peter Morgan in Zimbabwe. The various natural decom-

position processes taking place in alternating pits can be both aerobic and anaerobic in nature, depending on the technology and operating conditions. The main difference between Pit Humus and Compost is that the degradation processes are passive and are not subjected to a controlled oxygen supply, C:N ratio, humidity and temperature. Therefore, the rate of pathogen reduction is generally slower and the quality of the product, including its nutrient and organic matter content, can vary considerably. Pit Humus can look very similar to Compost and have good soil conditioning properties, although pathogens may still be present.

Pre-Treatment Products are materials separated from Blackwater, Brownwater, Greywater or Sludge in preliminary treatment units, such as screens, grease traps or grit chambers (see PRE, p. 100). Substances like fats, oil, grease, and various solids (e.g. sand, fibres and trash), can impair transport and/or treatment efficiency through clogging and wear. Therefore, early removal of these substances is crucial for the durability of a sanitation system.

Sludge is a mixture of solids and liquids, containing mostly Excreta and water, in combination with sand, grit, metals, trash and/or various chemical compounds. A distinction can be made between faecal Sludge and wastewater Sludge. Faecal Sludge comes from onsite sanitation technologies, i.e., it has not been transported through a sewer. It can be raw or partially digested, a slurry or semisolid, and results from the Collection and Storage/Treatment of Excreta or Blackwater, with or without Greywater. For a more detailed characterization of faecal Sludge refer to Strande et al., 2014 (see Sector Development Tools, p. 9). Wastewater Sludge (also referred to as sewage Sludge) is Sludge that originates from sewer-based wastewater collection and (Semi-) Centralized Treatment processes.

The Sludge composition will determine the type of treatment that is required and the end-use possibilities.

Stored Urine is Urine that has been hydrolysed naturally over time, i.e., the urea has been converted by enzymes into ammonia and bicarbonate. Stored Urine

has a pH of approximately 9. Most pathogens cannot survive at this pH. After 6 months of storage, the risk of pathogen transmission is considerably reduced.

Stormwater is the general term for the rainfall runoff collected from roofs, roads and other surfaces before flowing towards low-lying land. It is the portion of rainfall that does not infiltrate into the soil.

Urine is the liquid produced by the body to rid itself of urea and other waste products. In this context, the Urine product refers to pure Urine that is not mixed with Faeces or water. Depending on diet, human Urine collected from one person during one year (approx. 300 to 550 L) contains 2 to 4 kg of nitrogen. With the exception of some rare cases, Urine is sterile when it leaves the body.

Functional Groups

A functional group is a grouping of technologies that have similar functions. There are five different functional groups from which technologies can be chosen to build a system.

The five functional groups are:

- U User Interface** (Technologies U.1-U.6): Red
- S Collection and Storage/Treatment** (Technologies S.1-S.12): Orange
- C Conveyance** (Technologies C.1-C.7): Yellow
- T (Semi-) Centralized Treatment** (Technologies PRE, T.1-T.17, POST): Green
- D Use and/or Disposal** (Technologies D.1-D.13): Blue

Each functional group has a distinctive colour; technologies within a given functional group share the same colour code so that they are easily identifiable. Also, each technology within a functional group is assigned a reference code with a single letter and number; the letter corresponds to its functional group (e.g., U for User Interface) and the number, going from lowest to highest, indicates approximately how resource intensive (i.e., economic, material and human) the technology is compared to the other technologies within the group.

U User Interface (U) describes the type of toilet, pedestal, pan, or urinal with which the user comes in contact; it is the way by which the user accesses the sanitation system. In many cases, the choice of User Interface will depend on the availability of water. Note that Greywater and Stormwater do not originate at the User Interface, but may be treated along with the products that originate from it.

S Collection and Storage/Treatment (S) describes the ways of collecting, storing, and sometimes treating the products generated at the User Interface. The treatment provided by these technologies is often a function of storage and is usually passive (e.g., requiring no energy input). Thus, products that are ‘treated’ by these technologies often require subsequent treatment before Use and/or Disposal.

C Conveyance (C) describes the transport of products from one functional group to another. Although products may need to be transferred in various ways between functional groups, the longest, and most important gap is between User Interface or Collection and Storage/Treatment and (Semi-) Centralized Treatment. Therefore, for the sake of simplicity, Conveyance only describes the technologies used to transport products between these functional groups.

T (Semi-) Centralized Treatment (T) refers to treatment technologies that are generally appropriate for large user groups (i.e., neighbourhood to city level applications). The operation, maintenance, and energy requirements of technologies within this functional group are generally higher than for smaller-scale technologies at the S level. The technologies are divided into 2 groups: T.1-T.12 are primarily for the treatment of Blackwater, Brownwater, Greywater or Effluent, whereas T.13-T.17 are mainly for the treatment of Sludge. Technologies for pre-treatment and post-treatment are also described (technology information sheets PRE and POST).

D Use and/or Disposal (D) refers to the methods by which products are ultimately returned to the envi-

ronment, either as useful resources or reduced-risk materials. Furthermore, products can also be cycled back into a system (e.g., by using treated Greywater for flushing).

Sanitation Technologies

Technologies are defined as the specific infrastructure, methods, or services designed to contain and transform products, or to transport products to another functional group. Each of the 57 technologies included in this Compendium is described on a **Technology Information Sheet** in Part 2. There are between 6 and 17 different technologies within each of the five functional groups.

Only those sanitation technologies which have been proven and tested in the context of low- and middle-income countries are included. Moreover, they have only been included if they are considered “improved” in regards to the provision of safe, hygienic, and accessible sanitation. A wide variety of sanitation technologies in each functional group are either currently under development, exist only as prototypes or are not yet fully mature and available. Examples of the most interesting and promising developments with high potential for implementation in low- and middle-income countries are outlined in the section “Emerging Sanitation Technologies” (pp. 166-169). Hopefully, some of these technologies may be included in the form of a technology information sheet in a future edition of the Compendium.

The Compendium is primarily concerned with systems and technologies directly related to Excreta and does not specifically address Greywater or Stormwater management, although it does show when they can be co-treated with Excreta. This explains why the related Greywater and Stormwater technologies are not described in detail, but are still shown as products in the system templates. For a more comprehensive summary of dedicated Greywater systems and technologies, please refer to the following resource:

- Morel, A. and Diener, S. (2006). *Greywater Management in Low- and Middle-Income Countries. Review of Different Treatment Systems for Households or Neighbourhoods*. Swiss Federal Institute of Aquatic Science and Technology (Eawag), Dübendorf, CH. Available free for download at: www.sandec.ch

A system template defines a suite of compatible and proven technology combinations from which a sanitation system can be designed. The system templates can be used to identify and display complete systems which take into account the management of all product flows between User Interface and Use or Disposal, and to compare the different options that are available in specific contexts.

This first part of the Compendium explains in detail how the system templates are read and used, and includes a presentation of the different templates. It describes the main considerations and the type of applications for which each system template is appropriate.

The Compendium includes nine different system templates, ranging from simple (with few technology choices and products) to complex (with multiple technology choices and products). Each system template is distinct in terms of the number of products generated and processed. The nine system templates are:

- System 1: Single Pit System
- System 2: Waterless Pit System without Sludge Production
- System 3: Pour Flush Pit System without Sludge Production
- System 4: Waterless System with Urine Diversion
- System 5: Biogas System
- System 6: Blackwater Treatment System with Infiltration
- System 7: Blackwater Treatment System with Effluent Transport
- System 8: Blackwater Transport to (Semi-) Centralized Treatment System
- System 9: Sewerage System with Urine Diversion

These systems have all proven their feasibility in practical applications. Each has their own characteristic advantages and disadvantages, as well as scope of application. The Compendium, however, is not an exhaustive list of technologies and associated systems. In specific cases, technology combinations other than those presented in this document may be applicable.

Although the system templates are predefined, the Compendium user must select the appropriate technology from the options presented. The choice is context-specific and should be made based on the local environment (temperature, rainfall, etc.), culture (sitters, squatters, washers, wipers, etc.) and resources (human, financial and material).

Using the System Templates

A sanitation system can be visualized as a matrix of **functional groups** (columns) and **products** (rows) that are linked together where potential combinations exist. Such a graphical presentation gives an overview of the technology components of a system and of all the products that it manages.

Products are successively collected, stored, transported and transformed along different compatible technologies from the five functional groups. The output of

a technology in one functional group, thereby, becomes the input for the next.

It is not always necessary for a product to pass through a technology from each of the five functional groups; however, the ordering of the functional groups should usually be maintained regardless of how many of them are included within the sanitation system.

Figures 2 and 3 explain the structure and elements of a system template.

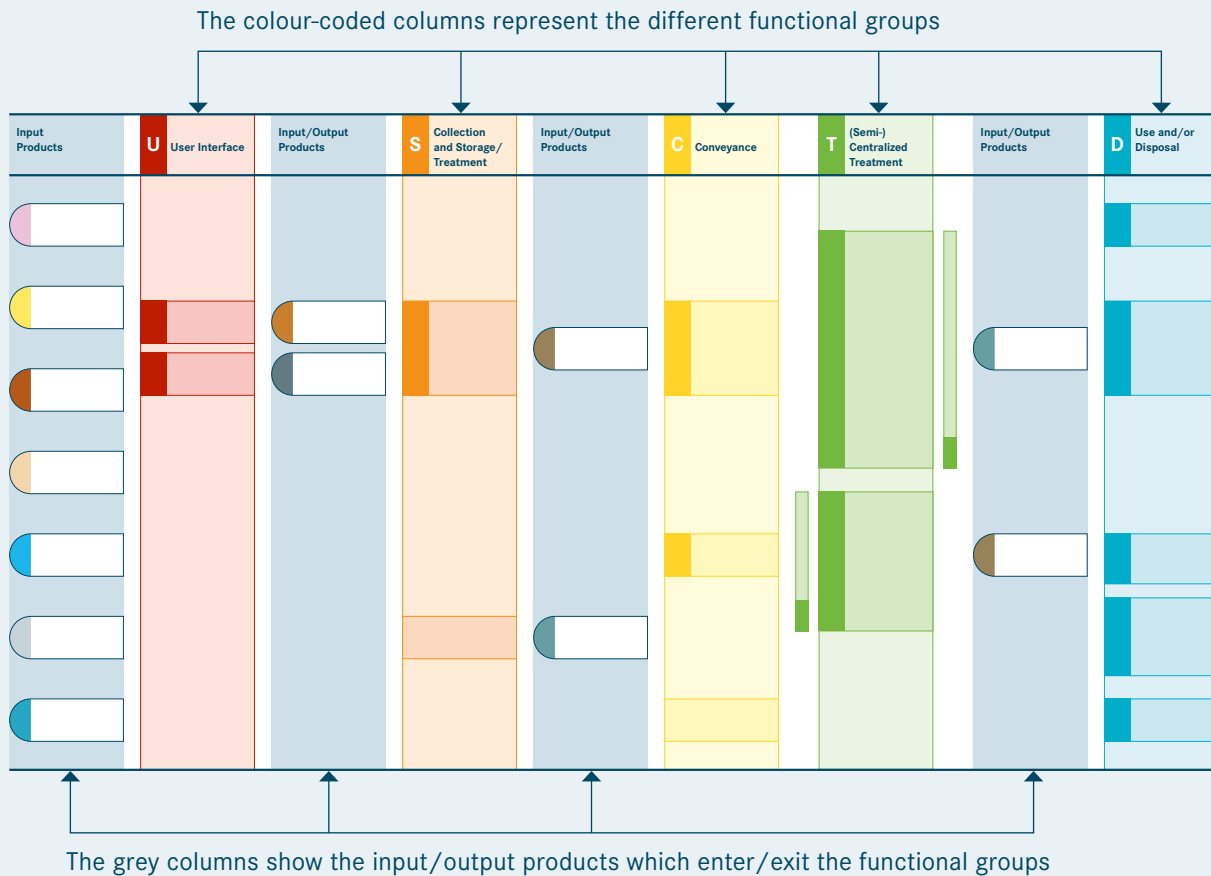
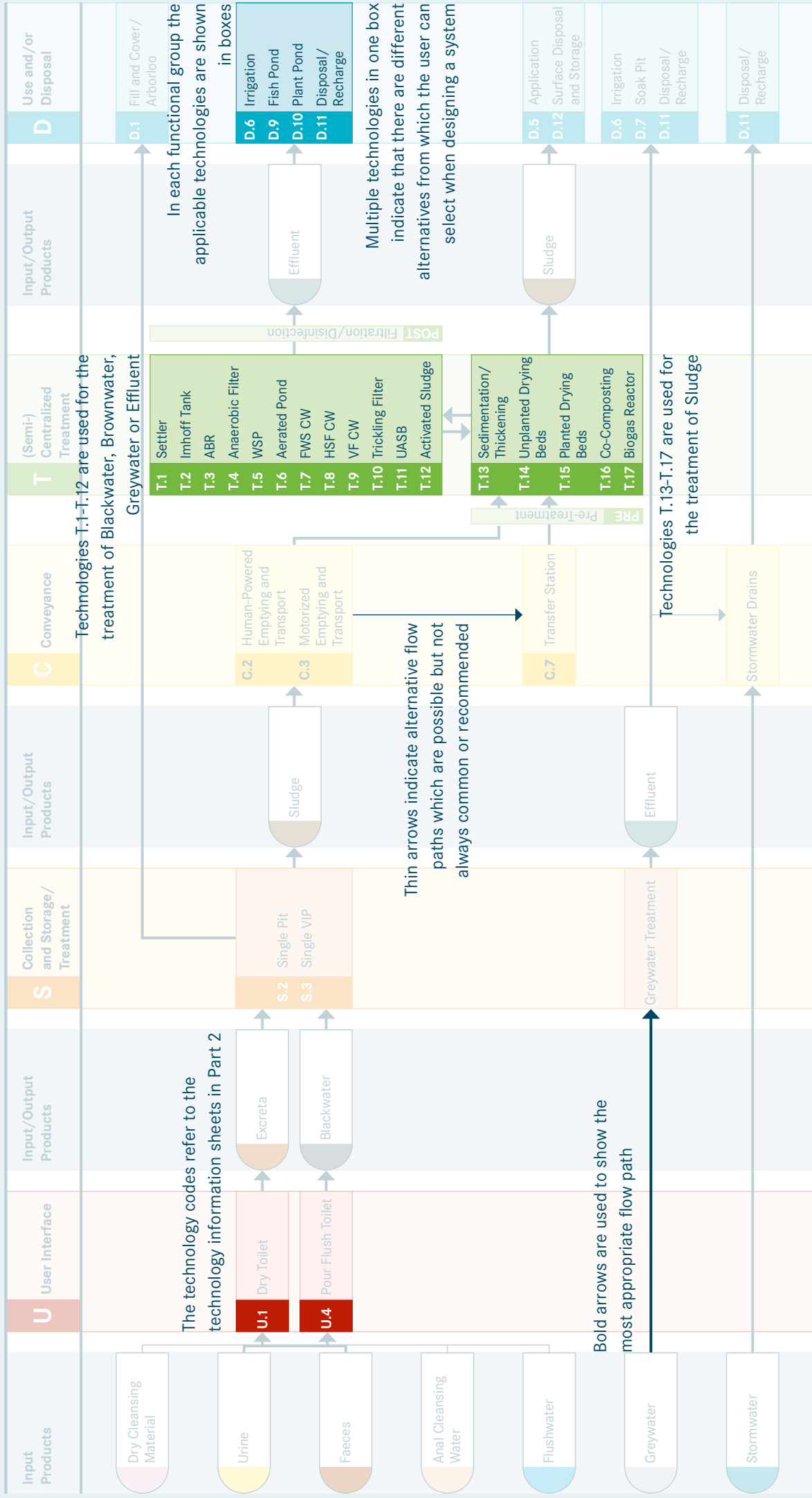

Figure 2: Explanation of the different columns of a system template

Figure 3: Explanation of the different graphical elements in a system template



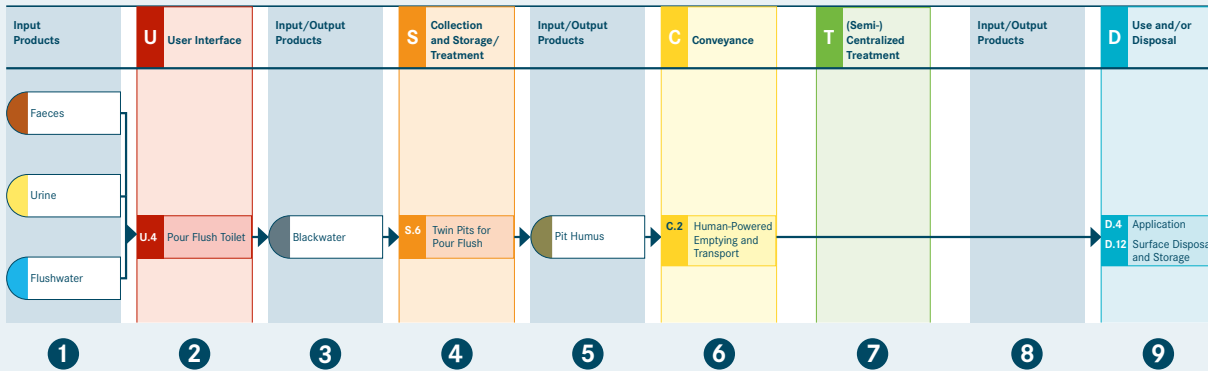

Figure 4: Example of how inputs enter into functional groups and are transformed

Figure 4 is an example from a system template. It shows how three products (Faeces, Urine and Flushwater) enter a system and are managed using different sanitation technologies. The following text describes how the products move from left to right through columns 1–9 of the system template.

1 Three inputs (Faeces, Urine and Flushwater) enter into 2 functional group U “User Interface” (Pour Flush Toilet). The Blackwater generated 3 then enters into 4 functional group S “Collection and Storage/Treatment” (Twin Pits for Pour Flush) and is transformed into 5 Pit Humus through storage and natural degra-

tion. The Pit Humus enters into 6 functional group C “Conveyance” (Human-Powered Emptying and Transport) and skips over 7 functional group T “(Semi-) Centralized Treatment” (as it should be hygienically safe), and with no further 8 input/output products. It is directly transported to the final 9 functional group D “Use and/or Disposal”, where two possibilities exist. Depending on the local conditions, needs and preferences, the Pit Humus can be applied as a soil conditioner in agriculture (Application) or brought to a temporary storage or final disposal site (Surface Disposal and Storage).

Steps for selecting sanitation options using the system templates

The nine system templates present the most logical combinations of technologies. However, the technologies and associated links are not exhaustive and planners should not lose a rational engineering perspective when trying to find the best possible solution for a specific context. Designers should attempt to minimize redundancy, optimize existing infrastructure and make use of local resources, while taking into account the local enabling environment (especially, factors such as skills and capacities, socio-cultural acceptance, financial resources and legal requirements).

The following procedure can be used to pre-select potential sanitation options:

1. Identify the products that are locally generated and/or available (e.g., Anal Cleansing Water, Flushwater or Organics for composting)
2. Identify the system templates that process the defined products
3. For each template, select a technology from each functional group where there is a technology choice presented (box with multiple technologies); the series of technologies make up a system
4. Compare the systems and iteratively change individual technologies or use a different system template based on user priorities, the demand for specific end-products (e.g., Compost), economic constraints, and technical feasibility

It may be useful to divide the planning zone under consideration into sub-areas so that each one has, within it, similar characteristics and conditions. The procedure can then be followed for each of the separate sub-areas, and any number of systems can be chosen.

Parts of a sanitation system may already exist; in that case it is the goal of the planners and engineers to integrate existing infrastructure or services, yet to maintain flexibility, with user satisfaction as the primary goal.

Selection of sanitation options in the CLUES planning approach

In Community-Led Urban Environmental Sanitation Planning (CLUES), the fifth of seven steps is the “Identification of Service Options”. The CLUES guidelines (see Sector Development Tools, p. 8) give a detailed description of how the Compendium can be used in participatory expert and community workshops to select and discuss appropriate sanitation solutions for an area. www.sandec.ch/clues

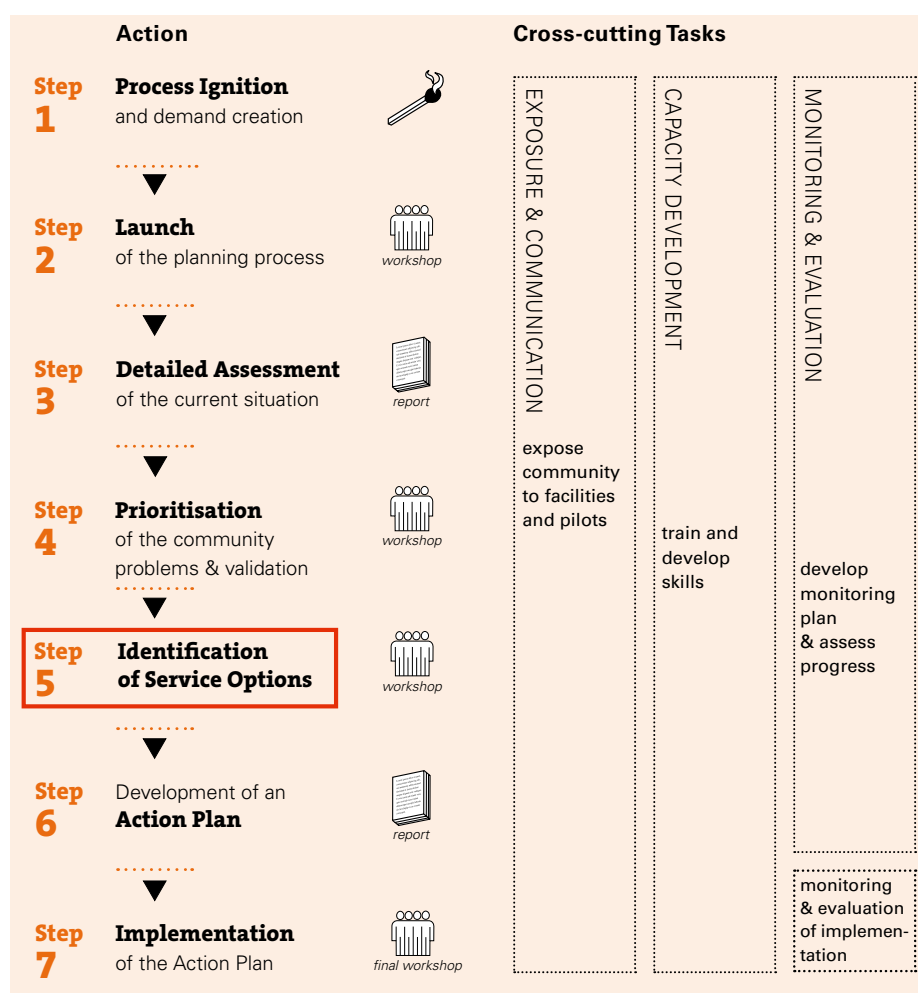
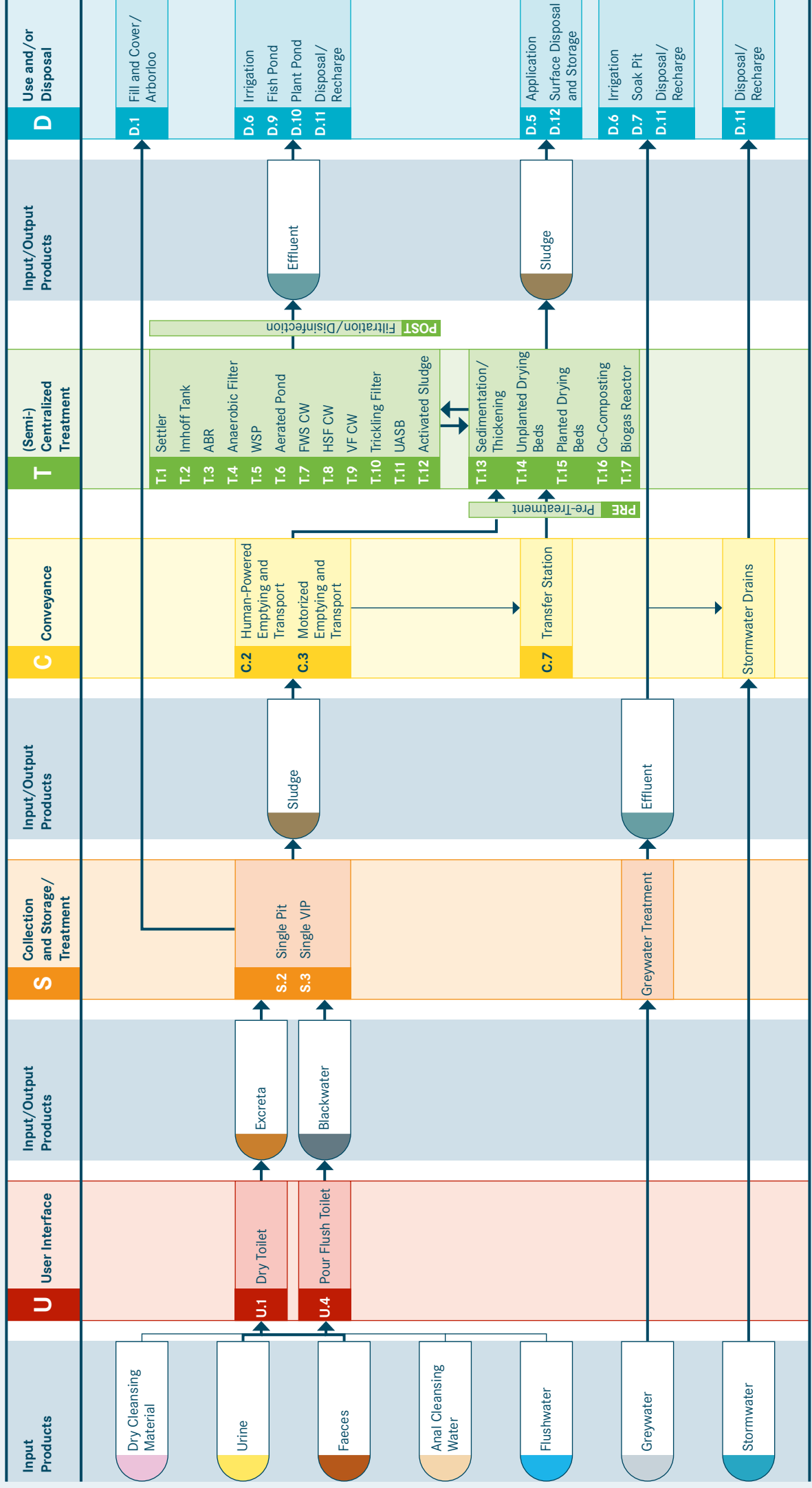

Figure 5: The seven steps of CLUES

A blank system template can be downloaded from www.sandec.ch/compendium. It can be printed and used to sketch site-specific sanitation systems, for example, when discussing different options with experts or stakeholders in a workshop. A PowerPoint template is also available for download

that has pre-defined graphical elements (such as products, technologies and arrows), facilitating the preparation of customized sanitation system drawings. The nine system templates are presented and described on the following pages. Each system template is explained in detail.

Sanitation System 1: Single Pit System



System 1: Single Pit System

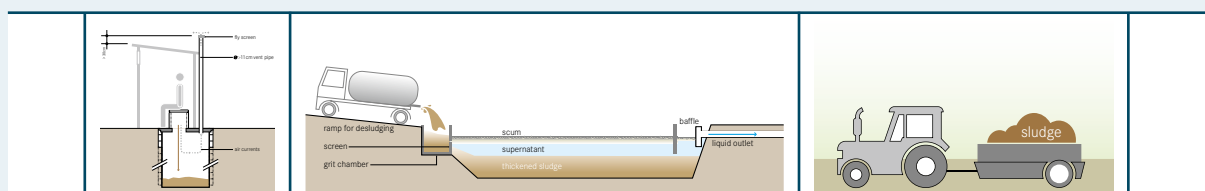

This system is based on the use of a single pit technology to collect and store Excreta. The system can be used with or without Flushwater, depending on the User Interface. Inputs to the system can include Urine, Faeces, Anal Cleansing Water, Flushwater and Dry Cleansing Materials. The use of Flushwater and/or Anal Cleansing Water will depend on water availability and local habit. The User Interface for this system can either be a Dry Toilet (U.1) or a Pour Flush Toilet (U.4). A Urinal (U.3) could additionally be used. The User Interface is directly connected to a Single Pit (S.2) or a Single Ventilated Improved Pit (VIP, S.3) for Collection and Storage/Treatment.

When the pit is full there are several options. If there is space, the pit can be filled with soil and a fruit or ornamental tree can be planted, which will thrive in the nutrient rich environment (D.1), and a new pit built. This is generally only possible when the superstructure is mobile. Alternatively, the faecal Sludge that is generated from the Collection and Storage/Treatment technology has to be removed and transported for further treatment. The Conveyance technologies that can be used include Human-Powered Emptying and Transport (C.2) or Motorized Emptying and Transport (C.3). A vacuum truck can only empty liquid faecal Sludge.

As the untreated faecal Sludge is highly pathogenic, human contact and direct agricultural application should be avoided. The Sludge that is removed should be transported to a dedicated faecal Sludge treatment facility (T.13-T.17). In the event that such a facility is not easily accessible, the faecal Sludge can be discharged to a Transfer Station (C.7). From there, it will be transported to the treatment facility by a motorized vehicle (C.3). A technology selection tree for faecal Sludge treatment plants is provided in Strande et al., 2014 (see Sector Development Tools, p. 9). (Semi-) Centralized Treatment technologies (T.1-T.17) produce both Effluent and Sludge, which may require further treatment prior to Use and/or Disposal. For example, Effluent from a faecal Sludge treatment facility could be co-treated with wastewater in Waste Stabilization Ponds (T.5) or Constructed Wetlands (T.7-T.9).

Options for the Use and/or Disposal of the treated Effluent include Irrigation (D.6), Fish Ponds (D.9), Floating

Plant Ponds (D.10) or discharge to a water body (Water Disposal/Groundwater Recharge, D.11). After adequate treatment, Sludge can either be used in agriculture (D.5) or brought to a Storage/Disposal site (D.12).

Considerations This system should be chosen only where there is either enough space to continuously dig new pits or when there is an appropriate way to empty, treat and dispose of the faecal Sludge. In dense urban settlements, there may not be sufficient space to access a pit for desludging or to make a new pit. This system is, therefore, best suited to rural and peri-urban areas where the soil is appropriate for digging pits and absorbing the leachate. It is not recommended for areas prone to heavy rains or flooding, which may cause pits to overflow.

Some Greywater in the pit may help degradation, but excessive amounts of Greywater may lead to quick filling of the pit and/or excessive leaching. All types of Dry Cleansing Materials can be discarded into the pit, although they may shorten the pit life and make it more difficult to empty. Whenever possible, Dry Cleansing Materials should be disposed of separately.

This system is one of the least expensive to construct in terms of capital cost. However, the maintenance costs may be considerable, depending on the frequency and method of pit emptying. If the ground is appropriate and has good absorptive capacity, the pit may be dug very deep (> 5m) and can be used for several years without emptying (up to 20 or more years). However, the groundwater level and use should be taken into consideration when digging pits in order to avoid contaminating it. Although different types of pits are common in most parts of the world, a well-designed pit-based system with appropriate transport, treatment and use or disposal is rare.

Guidelines for the safe use of Sludge have been published by the World Health Organization (WHO) and are referenced on the relevant technology information sheets.

Sanitation System 2: Waterless Pit System without Sludge Production

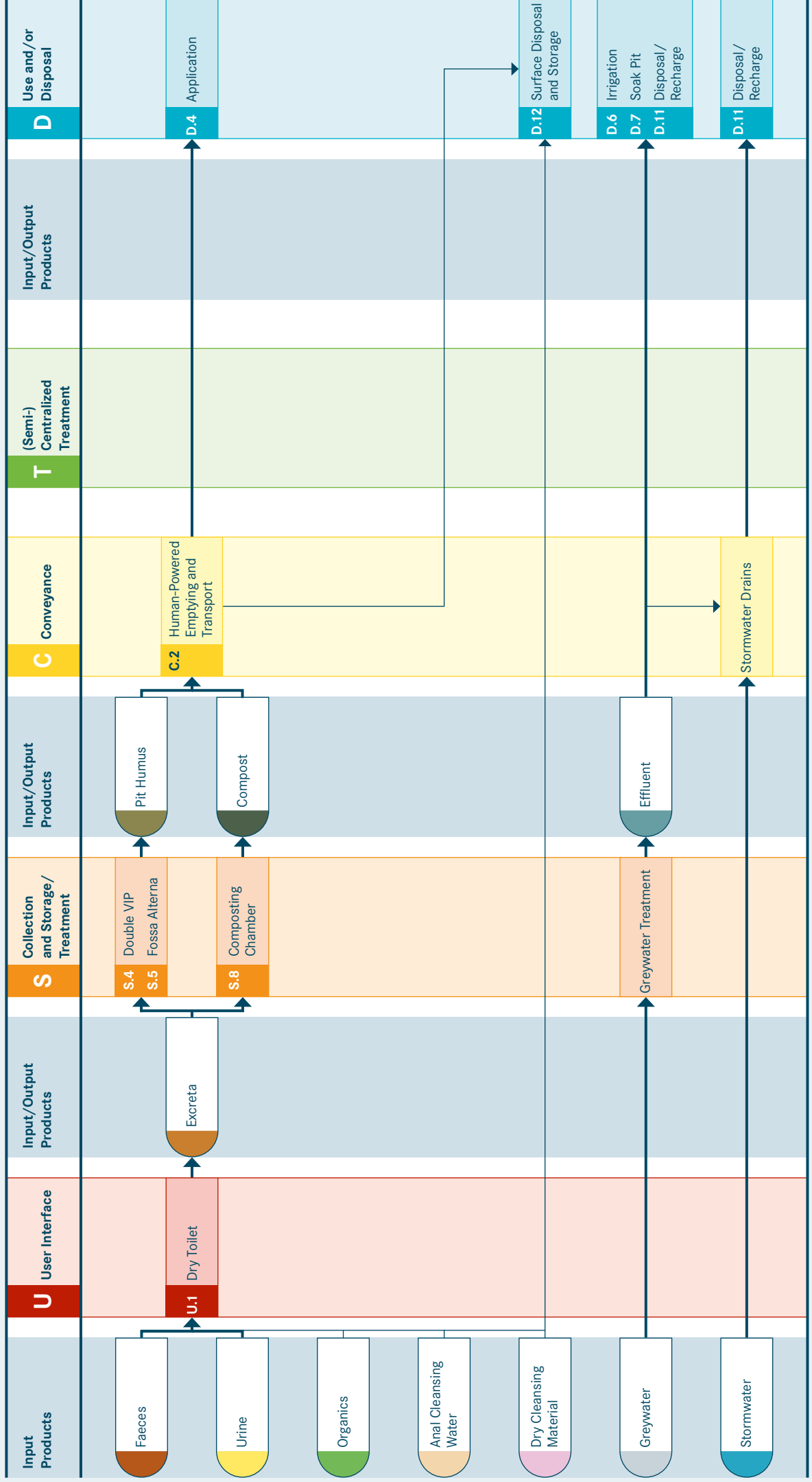

System 2: Waterless Pit System without Sludge Production

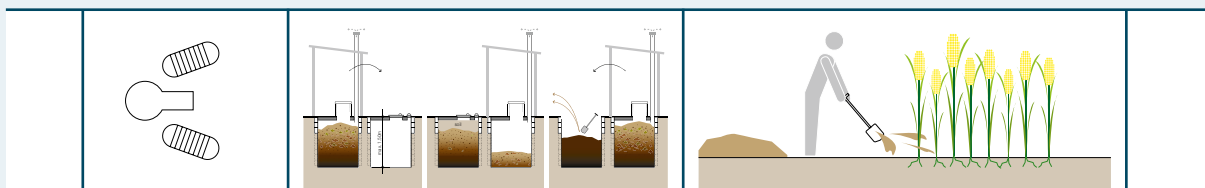

This system is designed to produce a solid, earth-like material by using alternating pits or a Composting Chamber (S.8). Inputs to the system can include Urine, Faeces, Organics, Anal Cleansing Water, and Dry Cleansing Materials. There is no use of Flushwater.

A Dry Toilet (U.1) is the recommended User Interface for this system, although a Urine-Diverting Dry Toilet (UDDT, U.2) or a Urinal (U.3) could also be used if the Urine is highly valued for application. A Dry Toilet does not require water to function and in fact, water should not be put into this system; Anal Cleansing Water should be kept at a minimum or even excluded if possible.

The User Interface is directly connected to a Double Ventilated Improved Pit (S.4), Fossa Alterna (S.5) or a Composting Chamber (S.8) for Collection and Storage/Treatment.

Two alternating pits, as in the Double VIP or Fossa Alterna, give the material an opportunity to drain, degrade, and transform into Pit Humus (sometimes also called EcoHumus), a nutrient-rich, hygienically improved, humic material which is safe to excavate. When the first pit is full, it is covered and temporarily taken out of service. While the other pit is filling with Excreta (and potentially Organics), the content of the first pit is allowed to rest and degrade. Only when both pits are full is the first pit emptied and put back into service. This cycle can be indefinitely repeated. As the Excreta in the resting pit is draining and degrading for at least one year, the resulting Pit Humus needs to be manually removed using shovels, and vacuum truck access to the pits is not necessary.

A Composting Chamber is not strictly a pit technology, but it can also have alternating chambers and, if properly operated, produces safe, useable Compost. For these reasons it is included in this system template.

The Pit Humus or Compost that is generated from the Collection and Storage/Treatment technology can be removed and transported for Use and/or Disposal manually using a Human-Powered Emptying and Transport service (C.2). Since it has undergone significant degradation, the humic material is quite safe to handle and use as soil conditioner in agriculture (D.4). If there are concerns about the quality of the Pit Humus or Compost, it can be further composted in a dedicated com-

posting facility before it is used. If there is no use for the product, it can be temporarily stored or permanently disposed of (D.12).

This system is different from System 1 (Single Pit System) regarding the product generated at Collection and Storage/Treatment level. In the previous system, the Sludge required further treatment before it could be used, whereas the Pit Humus and Compost produced in this system are ready for Use and/or Disposal following Collection and Storage/Treatment.

Considerations Because the system is permanent and can be indefinitely used (as opposed to some Single Pits, which may be filled and covered), it can be used where space is limited. Additionally, because the product must be manually removed, this system is suitable for dense areas that cannot be served by trucks for mechanical emptying (C.3). This system is especially appropriate for water-scarce areas and where there is an opportunity to use the humic product as soil conditioner. The material that is removed should be in a safe, useable form, although proper personal protection should be used during removal, transport and use.

The success of this system depends on proper operation and an extended storage period. If a suitable and continuous source of soil, ash or Organics (leaves, grass clippings, coconut or rice husks, woodchips, etc.) is available, the decomposition process is enhanced and the storage period can be reduced. The required storage time can be minimized if the material in the pit remains well aerated and not too moist. Therefore, the Greywater must be collected and treated separately. Too much moisture in the pit will fill the air voids and deprive the microorganisms of oxygen, which may impair the degradation process. Dry Cleansing Materials can usually be collected in the pit or chamber together with the Excreta, especially if they are carbon-rich (e.g., toilet paper, newsprint, corncobs, etc.) as this may help degradation and air flow.

Guidelines for the safe use of Excreta have been published by the World Health Organization (WHO) and are referenced on the relevant technology information sheets.

Sanitation System 3: Pour Flush Pit System without Sludge Production

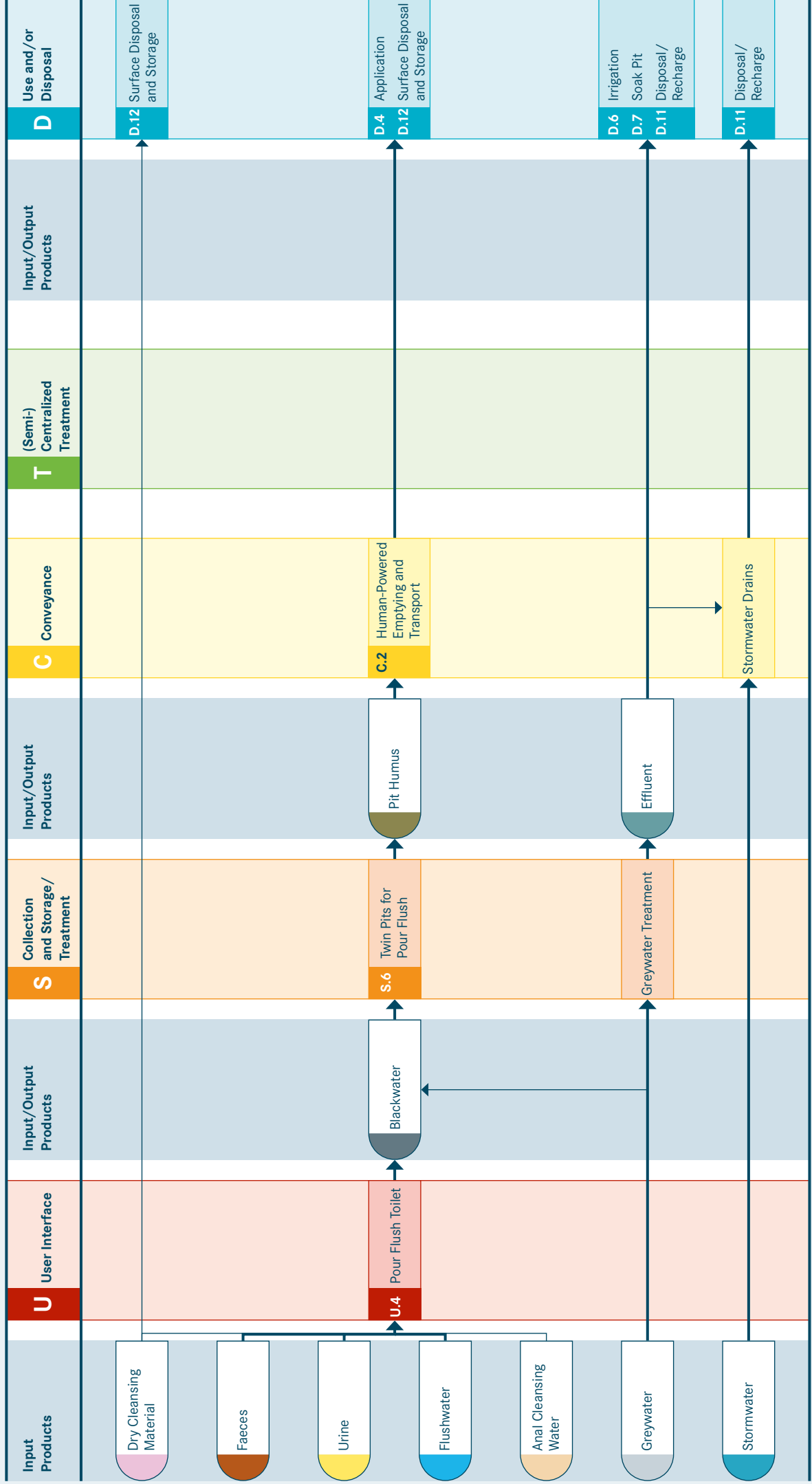

System 3: Pour Flush Pit System without Sludge Production

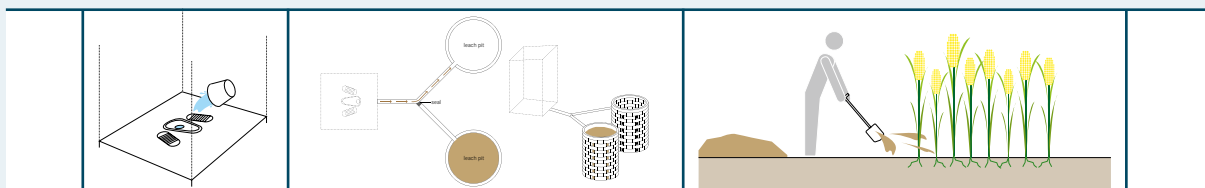

This is a water-based system utilizing the Pour Flush Toilet (pedestal or squat pan, U.4) and Twin Pits (S.6) to produce a partially digested, humus-like product, that can be used as a soil amendment. If water is not available, please refer to Systems 1, 2 and 4. Inputs to the system can include Faeces, Urine, Flushwater, Anal Cleansing Water, Dry Cleansing Materials and Greywater. The User Interface technology for this system is a Pour Flush Toilet (U.4). A Urinal (U.3) could additionally be used. The Blackwater output from the User Interface and possibly Greywater is discharged into Twin Pits for Pour Flush (S.6) for Collection and Storage/Treatment. The Twin Pits are lined with a porous material, allowing the liquid to infiltrate into the ground while solids accumulate and degrade at the bottom of the pit. While one pit is filling with Blackwater, the other pit remains out of service. When the first pit is full, it is covered and temporarily taken out of service. It should take a minimum of two years to fill a pit. When the second pit is full, the first pit is re-opened and emptied.

After a resting time of at least two years, the content is transformed into Pit Humus (sometimes also called EcoHumus), a nutrient-rich, hygienically improved, humic material which is safe to excavate. Since it has undergone significant dewatering and degradation, Pit Humus is much more hygienic than raw, undigested Sludge. Therefore, it does not require further treatment in a (Semi-) Centralized Treatment facility. The Pit Humus is removed using a Human-Powered Emptying and Transport (C.2) technology and transported for Use and/or Disposal. The emptied pit is then put back into operation. This cycle can be indefinitely repeated.

Pit Humus has good soil conditioning properties and can be applied in agriculture (D.4). If there are concerns about the quality of the Pit Humus, it can be further composted in a dedicated composting facility before it is used. If there is no use for the product, it can be temporarily stored or permanently disposed of (D.12).

Considerations This system is suited to rural and peri-urban areas with appropriate soil that can continually and adequately absorb the leachate. It is not appropriate for areas with clayey or densely packed soil. As leachate from Twin Pits directly infiltrates the surrounding soil, this system should only be installed where there is a low groundwater table that is not at risk of being contaminated from the pits. If there is frequent flooding or the groundwater table is too high and enters the Twin Pits, the dewatering process, particularly, in the resting pit, will be hindered. The material that is removed should be in a safe, useable form, although proper personal protection should be used during removal, transport and use.

Greywater can be co-managed along with the Blackwater in the Twin Pits, especially if the Greywater quantities are relatively small, and no other management system is in place to control it. However, large quantities of Flushwater and/or Greywater may result in excessive leaching from the pit and possibly groundwater contamination.

This system is well-suited for anal cleansing with water. If possible, Dry Cleansing Materials should be collected and disposed of separately (D.12) because they may clog the pipe fittings and prevent the liquid inside the pit from infiltrating into the soil.

Guidelines for the safe use of Excreta have been published by the World Health Organization (WHO) and are referenced on the relevant technology information sheets.

Sanitation System 4: Waterless System with Urine Diversion

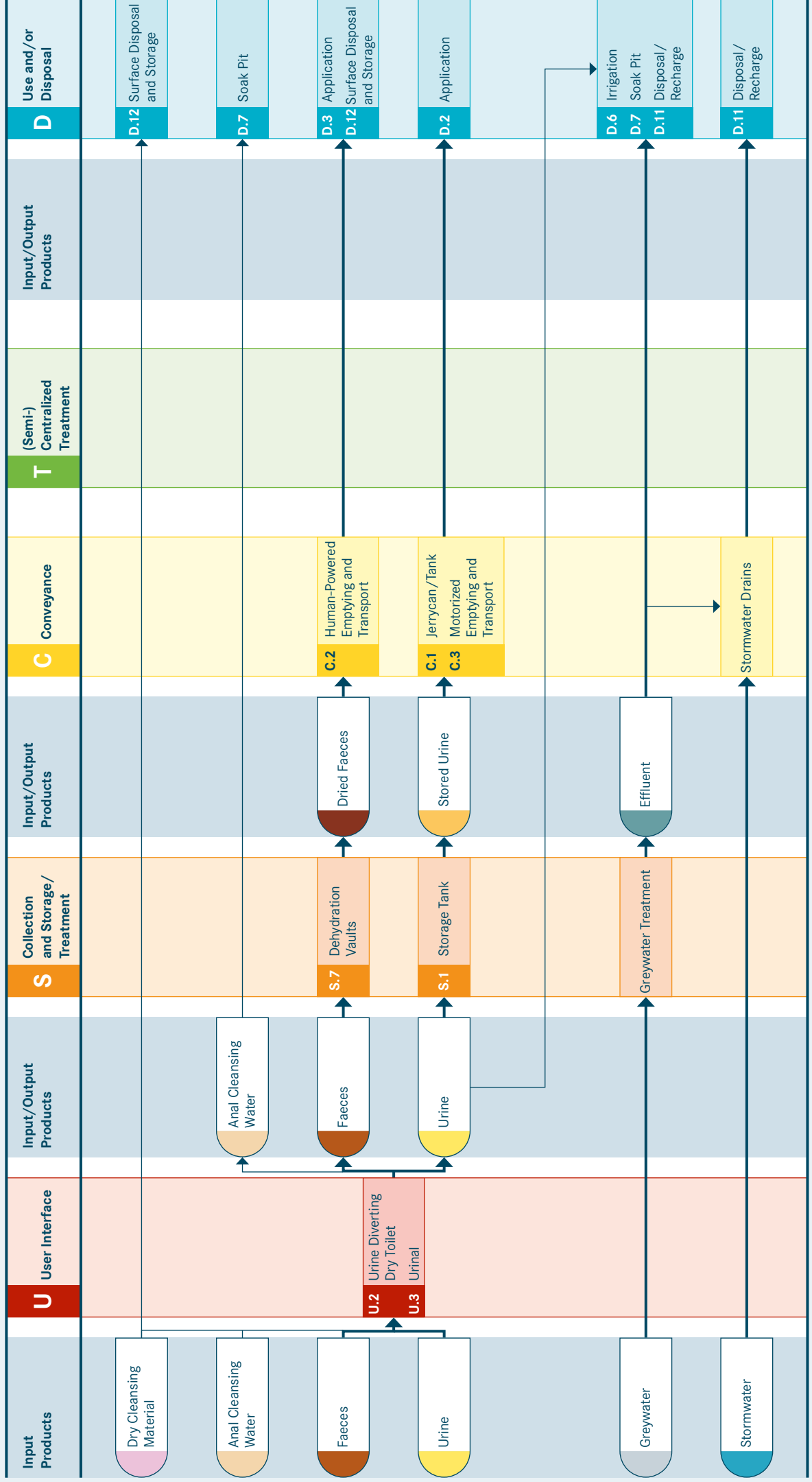

System 4: Waterless System with Urine Diversion

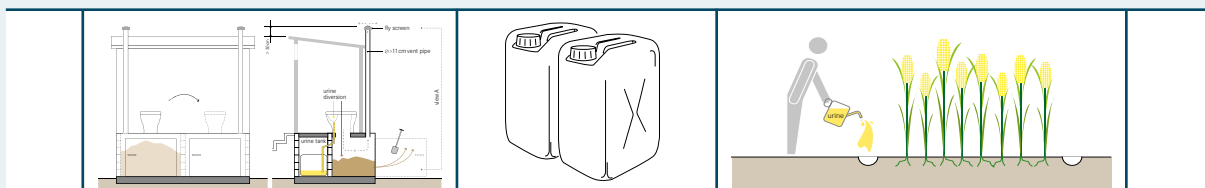

This system is designed to separate Urine and Faeces to allow the Faeces to dehydrate and/or recover the Urine for beneficial use. Inputs to the system can include Faeces, Urine, Anal Cleansing Water and Dry Cleansing Materials.

The main User Interface technology for this system is the Urine-Diverting Dry Toilet (UDDT, U.2), which allows Urine and Faeces to be separately collected. A Urinal (U.3) can additionally be installed for the effective collection of Urine. Different UDDT designs exist for different preferences (e.g., models with a third diversion for Anal Cleansing Water).

Dehydration Vaults (S.7) are used for the Collection and Storage/Treatment of Faeces. When storing the Faeces in vaults, they should be kept as dry as possible to encourage dehydration and pathogen reduction. Therefore, the chambers should be watertight and care should be taken to ensure that no water is introduced. Anal Cleansing Water should never be put into Dehydration Vaults, but it can be diverted and discharged into a Soak Pit (D.7). Also important is a constant supply of ash, lime, soil, or sawdust to cover the Faeces. This helps to absorb humidity, minimize odours and provide a barrier between the Faeces and potential vectors (flies). If ash or lime are used, the related pH increase will also help to kill pathogenic organisms.

For the Collection and Storage/Treatment of Urine, Storage Tanks (S.1) are used. Alternatively, Urine can also be diverted directly to the ground through an Irrigation system (D.6) or infiltrated through a Soak Pit (D.7). Stored Urine can be easily handled and poses little risk because it is nearly sterile. With its high nutrient content it can be used as a good liquid fertilizer. Stored Urine can be transported for Application in agriculture (D.2) using either Jerrycans or a Tank (C.1), or a Motorized Emptying and Transport technology (C.3) – the same way that bulk water or Sludge is transported to fields.

Human-Powered Emptying and Transport (C.2) is required for the removal and Conveyance of the Dried Faeces generated from the Dehydration Vaults. The alternating use of double Dehydration Vaults allows for an extended dehydration period so that the Dried

Faeces pose little human health risk when they are removed. A minimum storage time of 6 months is recommended when ash or lime are used as cover material. The Dried Faeces can then be applied as soil conditioner (D.3). If there are concerns about the quality of the material, it can be further composted in a dedicated composting facility before it is used. If there is no use for the product, it can be temporarily stored or permanently disposed of (D.12).

Considerations This system can be used anywhere, but is especially appropriate for rocky areas where digging is difficult, where there is a high groundwater table, or in water-scarce regions. The success of this system depends on the efficient separation of Urine and Faeces, as well as the use of a suitable cover material. A dry, hot climate can also considerably contribute to the rapid dehydration of the Faeces.

The material that is removed should be in a safe, useable form, although proper personal protection should be used during removal, transport and use.

A separate Greywater system is required since it should not be introduced into the Dehydration Vaults. If there is no agricultural need and/or no acceptance of using the urine, it can be directly infiltrated into the soil or into a Soak Pit. Where there are no suppliers of prefabricated UDDT pedestals or slabs, they can be locally manufactured using available materials.

All types of Dry Cleansing Materials can be used, although it is best to separately collect them as they will not decompose in the vaults and use up space. Anal Cleansing Water must be separated from the Faeces, but it can be mixed with the Urine if it is transferred to a Soak Pit. If Urine is used in agriculture, Anal Cleansing Water should be kept separate and infiltrated locally or treated along with Greywater.

Guidelines for the safe use of Faeces and Urine have been published by the World Health Organization (WHO) and are referenced on the relevant technology information sheets.

Sanitation System 5: Biogas System

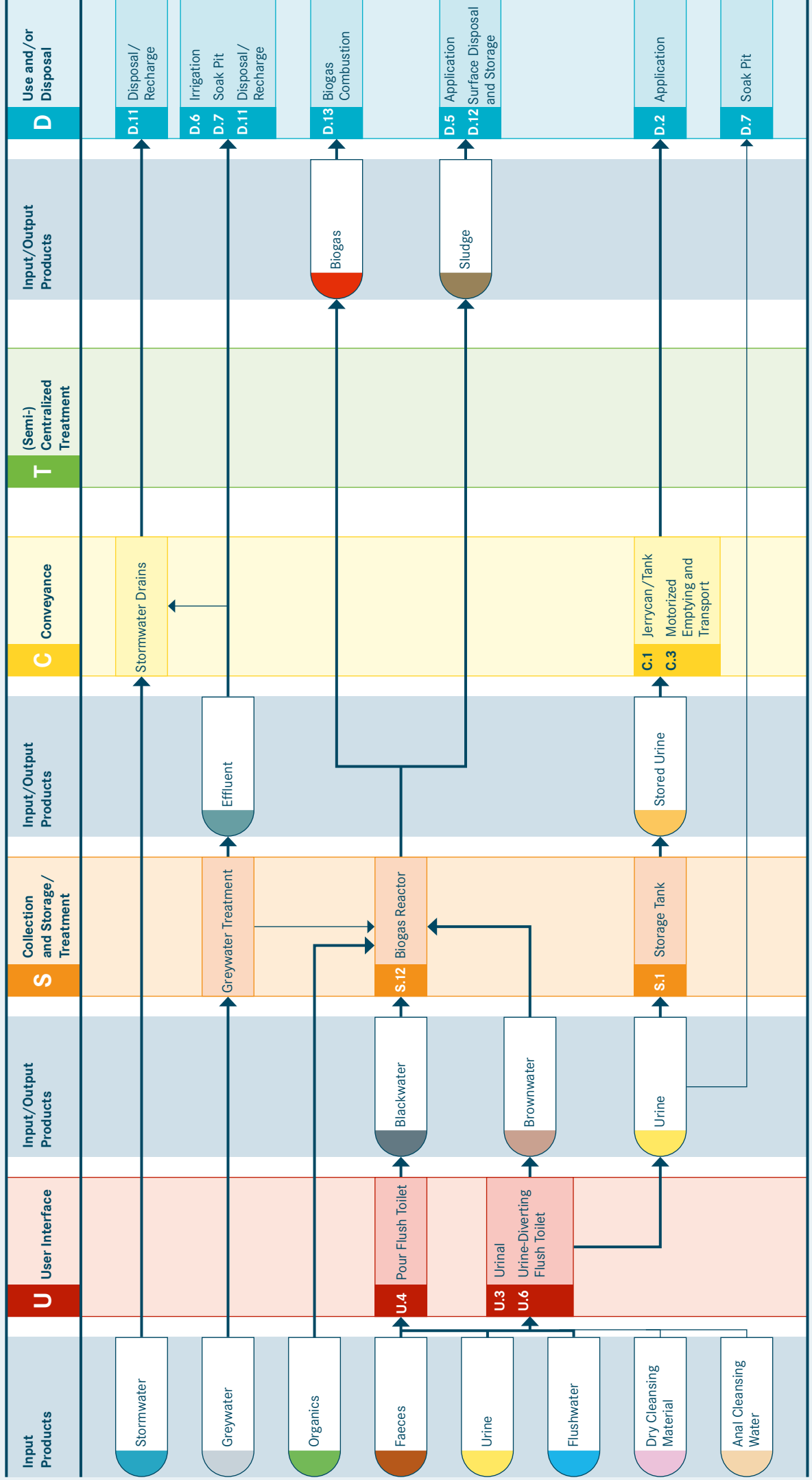

System 5: Biogas System

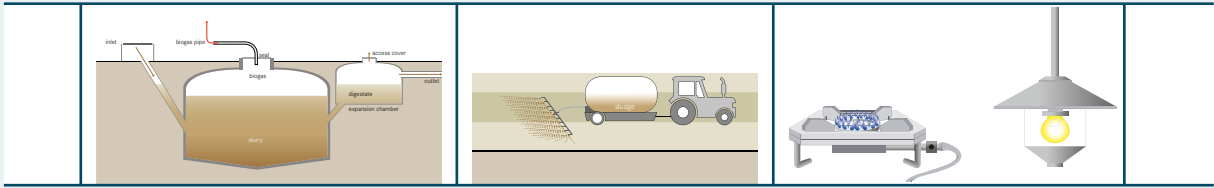

This system is based on the use of a Biogas Reactor (S.12) to collect, store and treat the Excreta. Additionally, the Biogas Reactor produces Biogas which can be burned for cooking, lighting or electricity generation. Inputs to the system can include Urine, Faeces, Flush-water, Anal Cleansing Water, Dry Cleansing Materials, Organics (e.g., market or kitchen waste) and, if available, animal waste.

This system supports two different User Interface technologies: a Pour Flush Toilet (U.4) or, if there is a demand for the urine to be used in agriculture, a Urine-Diverting Flush Toilet (U.6). A Urinal (U.3) could additionally be used. The User Interface is directly connected to a Biogas Reactor (S.12, also known as an anaerobic digester) for Collection and Storage/Treatment. If a Urine-Diverting Flush Toilet is installed (and/or a Urinal), it will be connected to a Storage Tank (S.1) for Urine collection.

Depending on the loading and design of the Biogas Reactor, a thin or thick digestate (Sludge) will be continuously discharged. Because of the high volume and weight of the material generated, the Sludge should be used onsite. In some circumstances, a very thin digestate can be discharged to a sewer (though this is not shown on the system template here).

Although the Sludge has undergone anaerobic digestion, it is not pathogen free and should be used with caution, especially if there is no further treatment. Depending on how it is used, additional treatment (e.g., in Planted Drying Beds, T.15) may be required before application. It is nutrient-rich and a good fertilizer that can be applied in agriculture (D.5) or transported to a Surface Disposal or Storage site (D.12). The Biogas produced must be constantly used, for example as a clean fuel for cooking or for lighting (D.13). If the gas is not burned, it will accumulate in the tank and, with increasing pressure, will push out the digestate until the Biogas escapes to the atmosphere through the digestate outlet.

A Biogas Reactor can work with or without Urine. The advantage of diverting Urine from the reactor is that it can be used separately as a concentrated nutrient source without pathogen contamination. The Urine

collected in the Storage Tank is ideally applied on local fields (D.2). Stored Urine can be transported in Jerrycans or a Tank (C.1), or using a Motorized Emptying and Transport technology (C.3).

Considerations This system is best suited to rural and peri-urban areas where there is appropriate space, a regular source of organic substrate for the Biogas Reactor and a use for the digestate and Biogas. The reactor itself can be built underground (e.g., under agricultural land, and in some cases roads) and, therefore, does not require a lot of space. Although a reactor may be feasible in a dense urban area, proper Sludge management is crucial and needs specific attention. Because the digestate production is continuous, there must be provisions made for year-round use and/or transport away from the site.

The Biogas Reactor can function with a large range of inputs and is especially suitable where a constant source of animal manure is available, or where market and kitchen waste is abundant. On farms, for example, large quantities of Biogas can be produced if animal manure is co-digested with the Blackwater, whereas significant gas production would not be achieved from human Excreta alone. Wood material or straw are difficult to degrade and should be avoided in the substrate. Achieving a good balance between Excreta (both human and animal), Organics and water can take some time, though the system is generally forgiving. However, care should be taken not to overload the system with either too many solids or too much liquid (e.g., Greywater should not be added into the Biogas Reactor as it substantially reduces the hydraulic retention time).

Most types of Dry Cleansing Materials and Organics can be discharged into the Biogas Reactor, although to accelerate digestion and ensure even reactions within the tank, large items should be broken or cut into small pieces.

Guidelines for the safe use of Sludge have been published by the World Health Organization (WHO) and are referenced on the relevant technology information sheets.

Sanitation System 6: Blackwater Treatment System with Infiltration

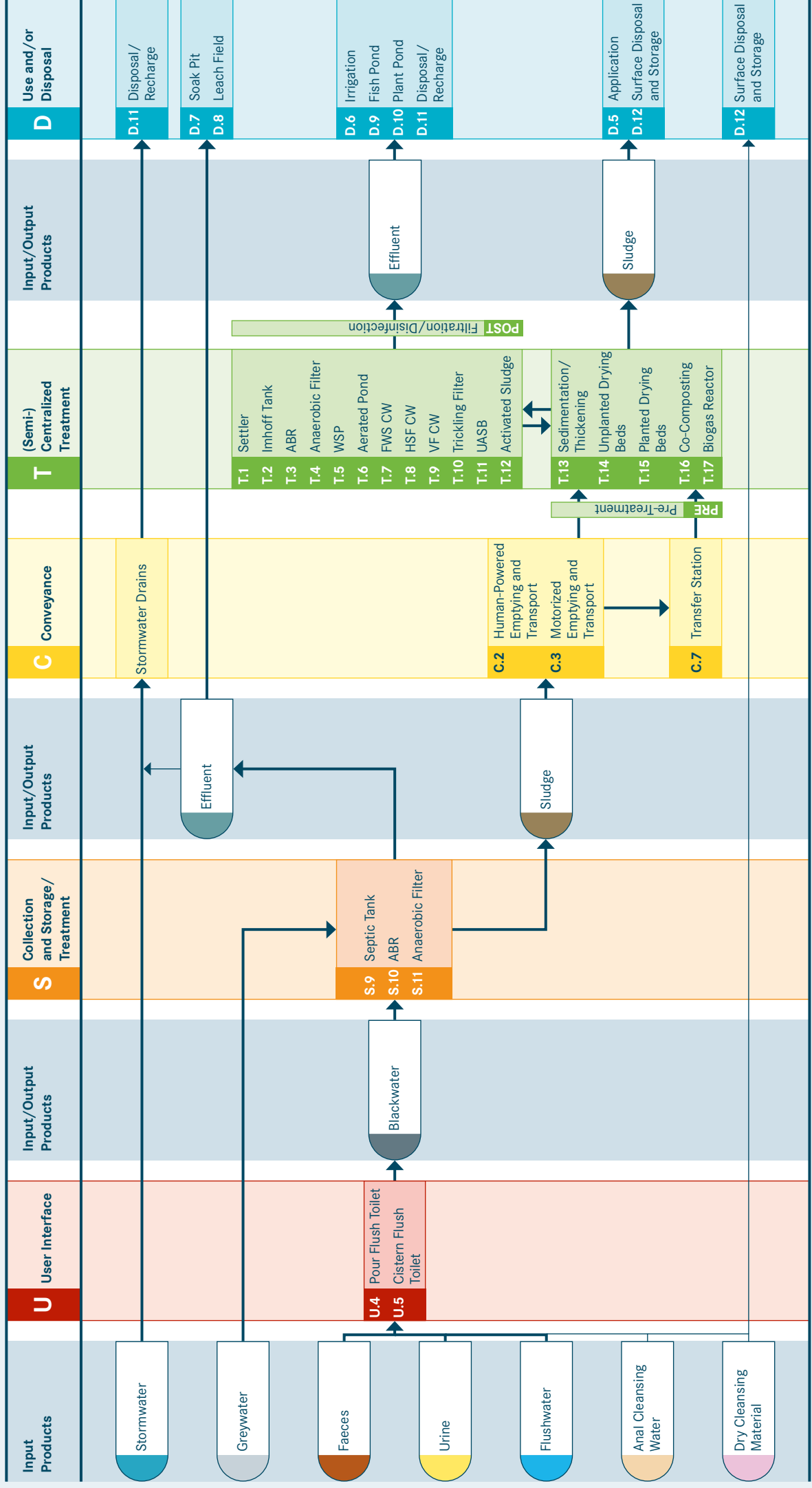

System 6: Blackwater Treatment System with Infiltration

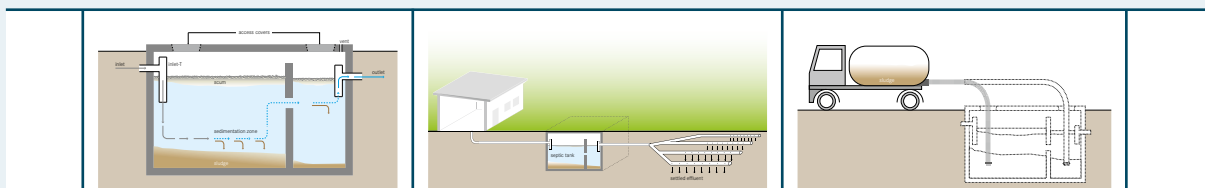

This is a water-based system that requires a flush toilet and a Collection and Storage/Treatment technology that is appropriate for receiving large quantities of water. Inputs to the system can include Faeces, Urine, Flushwater, Anal Cleansing Water, Dry Cleansing Materials and Greywater. There are two User Interface technologies that can be used for this system: a Pour Flush Toilet (U.4) or a Cistern Flush Toilet (U.5). A Urinal (U.3) could additionally be used. The User Interface is directly connected to a Collection and Storage/Treatment technology for the Blackwater that is generated: either a Septic Tank (S.9), an Anaerobic Baffled Reactor (ABR, S.10), or an Anaerobic Filter (S.11) may be used. The anaerobic processes reduce the organic and pathogen load, but the Effluent is still not suitable for direct use. Greywater should be treated along with Blackwater in the same Collection and Storage/Treatment technology, but if there is a need for water recovery, it can be treated separately (this is not shown on the system template). Effluent generated from the Collection and Storage/Treatment can be directly diverted to the ground for Use and/or Disposal through a Soak Pit (D.7) or a Leach Field (D.8). Although it is not recommended, the Effluent can also be discharged into the Stormwater drainage network for Water Disposal/Groundwater Recharge (D.11). This should only be considered if the quality of the Effluent is high and if there is no capacity for onsite infiltration or transportation offsite.

The Sludge that is generated from the Collection and Storage/Treatment technology must be removed and transported for further treatment. The Conveyance technologies that can be used include Human-Powered (C.2) or Motorized Emptying and Transport (C.3). As the Sludge is highly pathogenic prior to treatment, human contact and direct agricultural application should be avoided. The Sludge that is removed should be transported to a dedicated Sludge treatment facility (T.13-T.17). In the event that such a facility is not easily accessible, the Sludge can be discharged to a Transfer Station (C.7). From the Transfer Station it will then be transported to the treatment facility by a motorized vehicle (C.3).

A technology selection tree for Sludge treatment plants is provided in Strande et al., 2014 (see Sector Develop-

ment Tools, p. 9). (Semi-) Centralized Treatment technologies (T.1-T.17) produce both Effluent and Sludge, which may require further treatment prior to Use and/or Disposal. For example, Effluent from a Sludge treatment facility could be co-treated with wastewater in Waste Stabilization Ponds (T.5) or Constructed Wetlands (T.7-T.9).

Options for the Use and/or Disposal of the treated Effluent include Irrigation (D.6), Fish Ponds (D.9), Floating Plant Ponds (D.10) or discharge to a water body (Water Disposal/Groundwater Recharge, D.11). After adequate treatment, Sludge can either be used in agriculture (D.5) or brought to a Storage/Disposal site (D.12).

Considerations This system is only appropriate in areas where desludging services are available and affordable and where there is an appropriate way to dispose of the Sludge. For the infiltration technologies to work there must be sufficient available space and the soil must have a suitable capacity to absorb the Effluent. If this is not the case, refer to System 7 (Blackwater Treatment System with Effluent Transport). This system can be adapted for use in colder climates, even where there is ground frost. The system requires a constant source of water.

This water-based system is suitable for Anal Cleansing Water inputs, and, since the solids are settled and digested onsite, easily degradable Dry Cleansing Materials can also be used. However, rigid or non-degradable materials (e.g., leaves, rags) could clog the system and cause problems with emptying and, therefore, should not be used. In cases when Dry Cleansing Materials are collected separately from the flush toilets, they should be disposed of in an appropriate way (e.g., Surface Disposal, D.12).

The capital investment for this system is considerable (excavation and installation of an onsite storage and infiltration technology), but the costs can be shared by several households if the system is designed for a larger number of users.

Guidelines for the safe use of Effluent and Sludge have been published by the World Health Organization (WHO) and are referenced on the relevant technology information sheets.

Sanitation System 7: Blackwater Treatment System with Effluent Transport

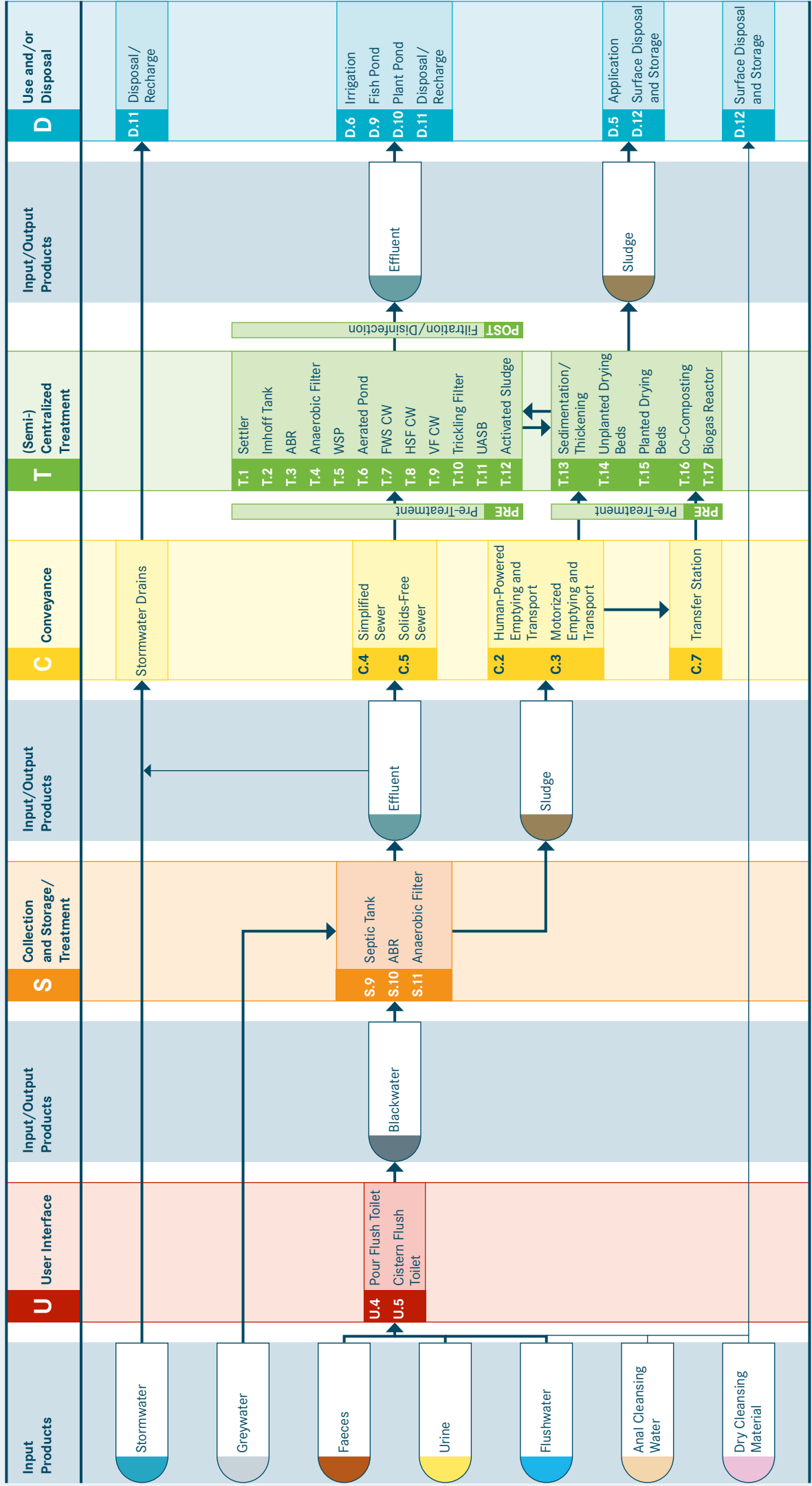

System 7: Blackwater Treatment System with Effluent Transport

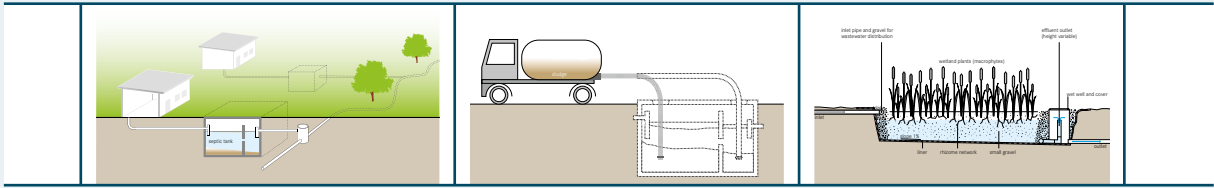

This system is characterized by the use of a household-level technology to remove and digest settleable solids from the Blackwater, and a Simplified (C.4) or Solids-Free (C.5) Sewer system to transport the Effluent to a (Semi-) Centralized Treatment facility. Inputs to the system can include Faeces, Urine, Flushwater, Anal Cleansing Water, Dry Cleansing Materials and Greywater.

This system is comparable to System 6 (Blackwater Treatment System with Infiltration) except that the management of the Effluent generated during Collection and Storage/Treatment of the Blackwater is different: the Effluent from Septic Tanks (S.9), Anaerobic Baffled Reactors (S.10) or Anaerobic Filters (S.11) is transported to a (Semi-) Centralized Treatment facility via a Simplified or a Solids-Free Sewer. The Collection and Storage/Treatment units serve as “interceptor tanks” and allow for the use of simplified small-diameter sewers, as the Effluent is free from settleable solids. Similar to System 6, the Effluent can also alternatively be discharged into the Stormwater drainage network for Water Disposal/Groundwater Recharge (D.11), although this is not the recommended approach. This should only be considered if the quality of the Effluent is high and transportation to a treatment plant is not feasible.

Effluent transported to a treatment facility is treated using a combination of the technologies T.1-T.12. As in System 6, the Sludge from the Collection and Storage/Treatment technology must be removed and transported for further treatment in a dedicated Sludge treatment facility (T.13-T.17).

A technology selection tree for Sludge treatment plants is provided in Strande et al., 2014 (see Sector Development Tools, p. 9). (Semi-) Centralized Treatment technologies (T.1-T.17) produce both Effluent and Sludge, which may require further treatment prior to Use and/or Disposal.

Options for the Use and/or Disposal of the treated Effluent include Irrigation (D.6), Fish Ponds (D.9), Floating Plant Ponds (D.10) or discharge to a water body (Water Disposal/Groundwater Recharge, D.11). After adequate treatment, Sludge can either be used in agriculture (D.5) or brought to a Storage/Disposal site (D.12).

Considerations This system is especially appropriate for urban settlements where the soil is not suitable for the infiltration of Effluent. Since the sewer network is shallow and (ideally) watertight, it is also applicable for areas with high groundwater tables. This system can be used as a way of upgrading existing, under-performing Collection and Storage/Treatment technologies (e.g., Septic Tanks) by providing improved treatment.

The success of this system depends on high user commitment concerning the operation and maintenance of the sewer network. A person or organization can be made responsible on behalf of the users. There must be an affordable and systematic method for desludging the interceptors since one user’s improperly maintained tank could adversely impact the entire sewer network. Also important is a well-functioning and properly maintained treatment facility. In some cases this will be managed at the municipal or regional level. In the case of a more local, small-scale solution (e.g., constructed wetlands), operation and maintenance responsibilities could also be organized on the community level.

This water-based system is suitable for Anal Cleansing Water inputs, and, since the solids are settled and digested onsite, easily degradable Dry Cleansing Materials can be used. However, rigid or non-degradable materials (e.g., leaves, rags) could clog the system and cause problems with emptying and, therefore, should not be used. In cases when Dry Cleansing Materials are separately collected from the flush toilets, they should be disposed of in an appropriate way (e.g., Surface Disposal, D.12).

With the offsite transport of the Effluent to a (Semi-) Centralized Treatment facility, the capital investment for this system is considerable. Installation of an onsite Collection and Storage/Treatment technology may be costly, but the design and installation of a Simplified or Solids-Free Sewer will be considerably less expensive than a Conventional Gravity Sewer network. The offsite treatment plant itself is also an important cost factor, particularly, if there is no pre-existing facility to which the sewer can be connected.

Guidelines for the safe use of Effluent and Sludge have been published by the World Health Organization (WHO) and are referenced on the relevant technology information sheets.

Sanitation System 8: Blackwater Transport to (Semi-) Centralized Treatment System

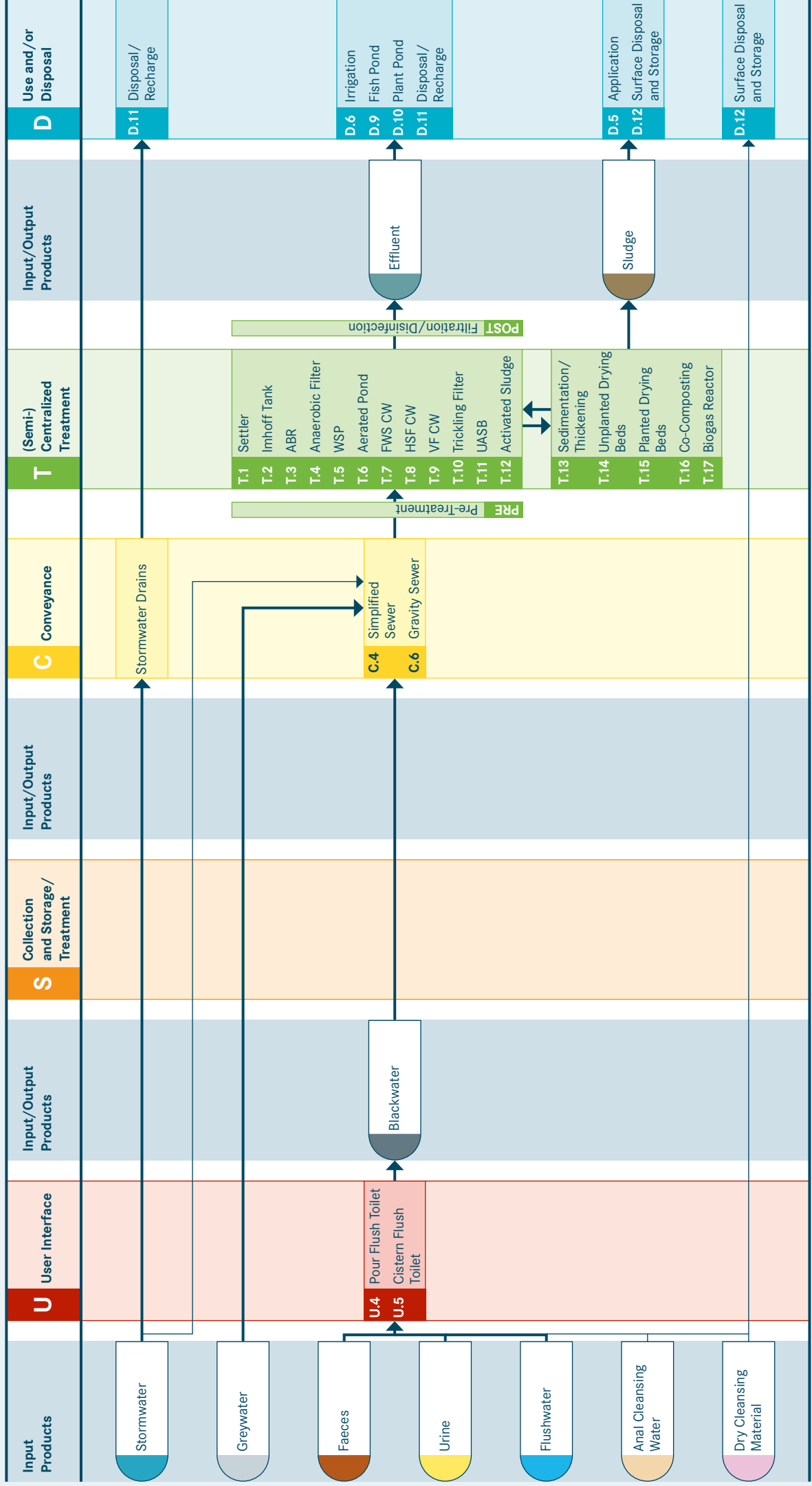

System 8: Blackwater Transport to (Semi-) Centralized Treatment System

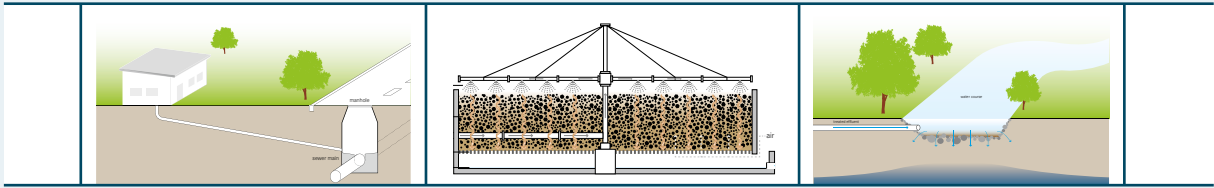

This is a water-based sewer system in which Blackwater is transported to a Centralized or Semi-Centralized Treatment facility. The important characteristic of this system is that there is no Collection and Storage/Treatment. Inputs to the system include Faeces, Urine, Flushwater, Anal Cleansing Water, Dry Cleansing Materials, Greywater and possibly Stormwater.

There are two User Interface technologies that can be used for this system: a Pour Flush Toilet (U.4) or a Cistern Flush Toilet (U.5). A Urinal (U.3) could additionally be used. The Blackwater that is generated at the User Interface together with Greywater is directly conveyed to a (Semi-) Centralized Treatment facility through a Simplified (C.4) or a Conventional Gravity Sewer network (C.6).

Stormwater could also be put into the Gravity Sewer network, although this would dilute the wastewater and require Stormwater overflows. Therefore, local retention and infiltration of Stormwater or a separate drainage system for rainwater are the recommended approaches.

As there is no Collection and Storage/Treatment, all of the Blackwater is transported to a (Semi-) Centralized Treatment facility. The inclusion of Greywater in the Conveyance technology helps to prevent solids from accumulating in the sewers.

A combination of the technologies T.1-T.12 is required for the treatment of the transported Blackwater. The Sludge generated from these technologies must be further treated in a dedicated Sludge treatment facility (technologies T.13-T.17) prior to Use and/or Disposal.

Options for the Use and/or Disposal of the treated Effluent include Irrigation (D.6), Fish Ponds (D.9), Floating Plant Ponds (D.10) or discharge to a water body (Water Disposal/Groundwater Recharge, D.11). After adequate treatment, Sludge can either be used in agriculture (D.5) or brought to a Storage/Disposal site (D.12).

Considerations This system is especially appropriate for dense, urban and peri-urban settlements where there is little or no space for onsite storage technologies or emptying. The system is not well-suited to rural areas with low housing densities. Since the sewer network is (ideally) watertight, it is also applicable for areas with high groundwater tables. There must be a constant supply of water to ensure that the sewers do not become blocked.

Dry Cleansing Materials can be handled by the system or they can be collected and separately disposed of (e.g., Surface Disposal, D.12).

The capital investment for this system can be very high. Conventional Gravity Sewers require extensive excavation and installation that is expensive, whereas Simplified Sewers are generally less expensive if the site conditions permit a condominal design. Users may be required to pay user fees for the system and its maintenance. Depending on the sewer type and management structure (Simplified vs. Conventional, city-run vs. community-operated) there will be varying degrees of operation or maintenance responsibilities for the homeowner.

This system is most appropriate when there is a high willingness and ability to pay for the capital investment and maintenance costs and where there is a pre-existing treatment facility that has the capacity to accept additional flow.

Guidelines for the safe use of Effluent and Sludge have been published by the World Health Organization (WHO) and are referenced on the relevant technology information sheets.

Sanitation System 9: Sewerage System with Urine Diversion

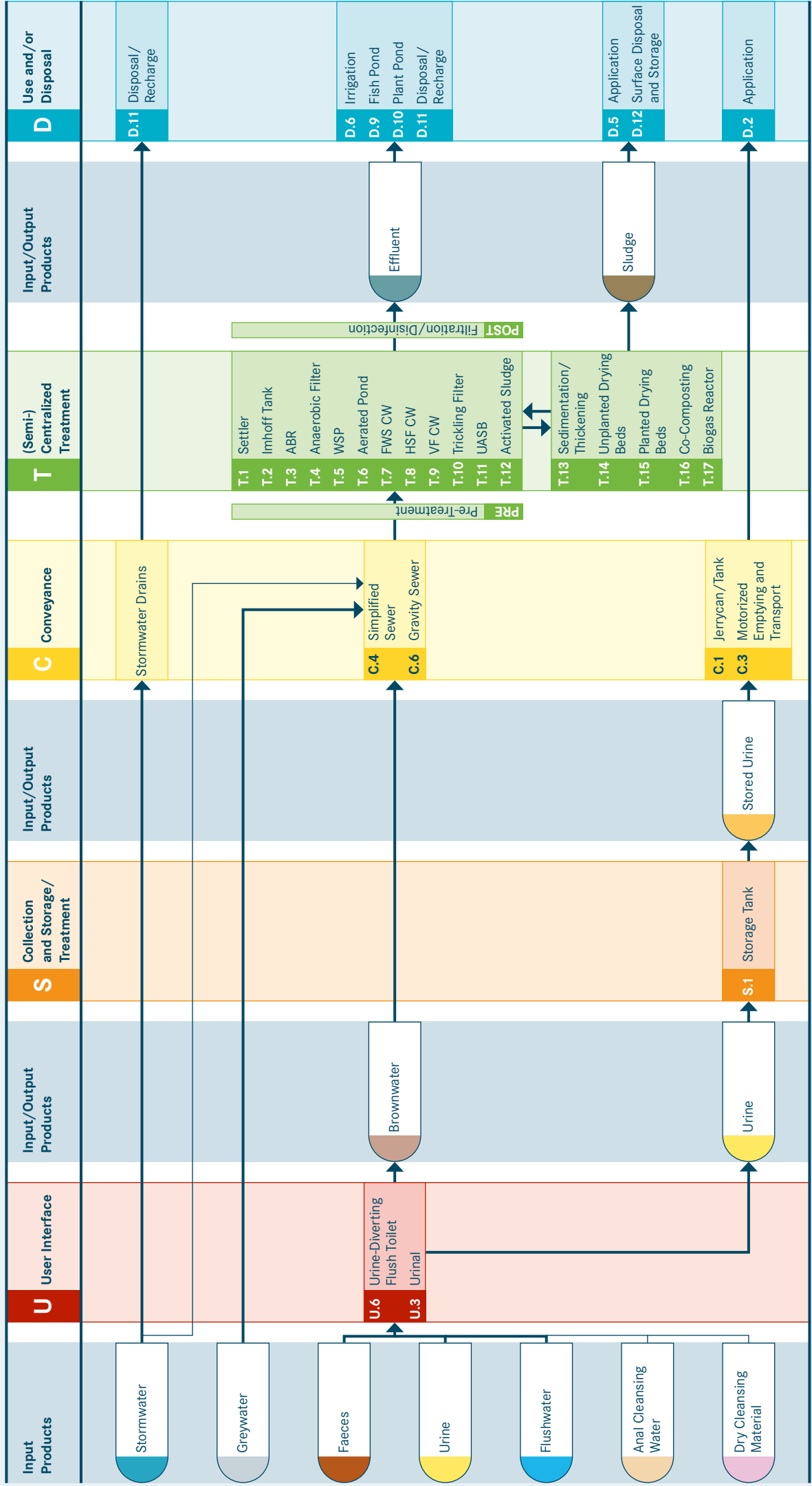

System 9: Sewerage System with Urine Diversion

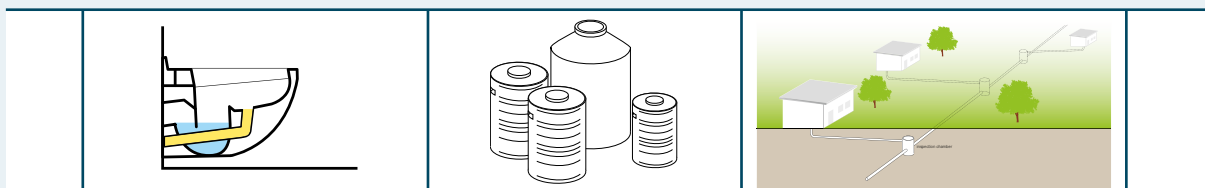

This is a water-based system that requires a Urine-Diverting Flush Toilet (UDFT, U.6) and a sewer. The UDFT is a special User Interface that allows for the separate collection of Urine without water, although it uses water to flush Faeces. Inputs to the system can include Faeces, Urine, Flushwater, Anal Cleansing Water, Dry Cleansing Materials, Greywater and possibly Stormwater.

The main User Interface technology for this system is the UDFT (U.6). A Urinal (U.3) can be an additional installation for the effective collection of Urine. Brownwater and Urine are separated at the User Interface. Brownwater bypasses a Collection and Storage/Treatment technology and is conveyed directly to a (Semi-) Centralized Treatment facility using a Simplified (C.4) or a Conventional Gravity Sewer network (C.6). Greywater is also transported in the sewer and is not separately treated.

Stormwater could also be put into the Gravity Sewer network, although this would dilute the wastewater and require Stormwater overflows. Therefore, local retention and infiltration of Stormwater or a separate drainage system for rainwater are the recommended approaches.

Urine diverted at the User Interface is collected in a Storage Tank (S.1). Stored Urine can be handled easily and with little risk because it is nearly sterile. With its high nutrient content it can be used as a good liquid fertilizer. Stored Urine can be transported for Application in agriculture (D.2) either using Jerrycans or a Tank (C.1), or a Motorized Emptying and Transport technology (C.3) – the same way that bulk water or Sludge is transported to fields.

Brownwater is treated at a (Semi-) Centralized Treatment facility using a combination of the technologies T.1-T.12. The Sludge generated from these technologies must be further treated in a dedicated Sludge treatment facility (technologies T.13-T.17) prior to Use and/or Disposal. Options for the Use and/or Disposal of the treated Effluent include Irrigation (D.6), Fish Ponds (D.9), Floating Plant Ponds (D.10) or discharge to a water body (Water Disposal/Groundwater Recharge, D.11). After adequate treatment, Sludge can either be used in agriculture (D.5) or brought to a Storage/Disposal site (D.12).

Considerations This system is only appropriate when there is a need for the separated Urine and/or when there is a desire to limit water consumption by using a low-flush UDFT (although the system still requires a constant source of water). There may also be benefits to the treatment plant if it is normally overloaded; the reduced nutrient load (by removing the Urine) could optimize treatment. However, if the plant is currently underloaded (i.e., it has been overdesigned), then this system could further aggravate the problem. Depending on the type of sewers used, this system can be adapted for both dense urban and peri-urban areas. It is not well-suited to rural areas with low housing densities. Since the sewer network is (ideally) watertight, it is also applicable for areas with high groundwater tables.

Dry Cleansing Materials can be handled by the system or they can be collected and separately disposed of (e.g., Surface Disposal, D.12).

UDFTs are not common and the capital cost for this system can be very high. This is partly due to the fact that there is limited competition in the User Interface market and also because high quality workmanship is required for the dual plumbing system. Conventional Gravity Sewers require extensive excavation and installation which is expensive, whereas Simplified Sewers are generally less expensive if the site conditions permit a condominal design. Users may be required to pay user fees for the system and its maintenance. Depending on the sewer type and management structure (Simplified vs. Conventional, city-run vs. community-operated, Urine transport and Application) there will be varying degrees of operation or maintenance responsibilities for the homeowner.

This system is most appropriate when there is a high willingness and ability to pay for the capital investment and maintenance costs and where there is a pre-existing treatment facility that has the capacity to accept additional flow.

Guidelines for the safe use of Urine, Effluent and Sludge have been published by the World Health Organization (WHO) and are referenced on the relevant technology information sheets.

Part 2: Functional Groups with Technology Information Sheets

The second part of the Compendium provides an overview of the different sanitation technologies within each functional group by explaining how they work, where they can be used and their advantages and disadvantages.

For each technology described in the system templates, there is a **technology information sheet** that includes an illustration, a summary of the technology, and a discussion of its appropriate applications and limitations. An explanation of how to read the technology information sheets is given on the following two pages.

The double-page description of the technologies is not intended to be a design manual or technical reference; rather, it is meant to be a starting point for further detailed design. Moreover, the technology descriptions are to serve as a source of inspiration and discussion amongst engineers and planners who may not have previously considered all of the feasible options.

The technologies are arranged and colour-coded according to the associated functional group:

U **User Interface** (Technologies U.1-U.6): Red

S **Collection and Storage/Treatment** (Technologies S.1-S.12): Orange

C **Conveyance** (Technologies C.1-C.7): Yellow

T **(Semi-) Centralized Treatment** (Technologies PRE, T.1-T.17, POST): Green

D **Use and/or Disposal** (Technologies D.1-D.13): Blue

Each technology within a given functional group is assigned a reference code with a single letter and number; the letter corresponds to the functional group (e.g., U for User Interface) and the number, going from lowest to highest, indicates approximately how resource intensive (i.e., economic, material and human) the technology is compared to the other technologies within the group.

The closing section introduces newly emerging technologies, which although still under development and being tested, show great promise for future application.

Reading the Technology Information Sheets

The following figure is an example of the heading of a technology information sheet.

S.8		Composting Chamber		Applicable to: System 2
Application Level: <input checked="" type="checkbox"/> Household <input checked="" type="checkbox"/> Neighbourhood <input type="checkbox"/> City		Management Level: <input checked="" type="checkbox"/> Household <input checked="" type="checkbox"/> Shared <input checked="" type="checkbox"/> Public		Inputs: <input type="checkbox"/> Excreta <input type="checkbox"/> Faeces <input type="checkbox"/> Organics (+ <input type="checkbox"/> Dry Cleansing Materials)
		Outputs: <input type="checkbox"/> Compost <input type="checkbox"/> Effluent		

1 The title with colour, letter and number code.

The colour code (orange) and the letter (S) indicate that the technology belongs to the functional group Collection and Storage/Treatment (S). The number (8) indicates that it is the eighth technology within that functional group.

Each technology description page has a similar colour, letter and number code, allowing for easy access and cross-referencing.

2 Applicable to System 2. This indicates in which system template the technology can be found. In this case, the Composting Chamber can be found (and only found) in System 2. Other technologies may be applicable to more than one system.

3 Application Level. Three spatial levels are defined under this heading:

- *Household* implies that the technology is appropriate for one or several households.
- *Neighbourhood* means that the technology is appropriate for anywhere between several and several hundred households.
- *City* implies that the technology is appropriate at the city-wide level (either one unit for the whole city, or many units for different parts of the city).

Stars are used to indicate how appropriate each level is for the given technology:

- *two* stars means suitable,
- *one* star means less suitable, and
- *no* star means not suitable.

It is up to the Compendium user to decide on the appropriate level for the specific situation that he/she is working on.

The Application Level graphic is only meant to be a rough guide to be used in the preliminary planning stage.

The technologies within the functional group User Interface do not include an Application Level since they can only service a limited number of people.

4 Management Level describes the organizational style best used for the operation and maintenance (O&M) of the given technology:

- *Household* implies that the household, e.g., the family, is responsible for all O&M.
- *Shared* means that a group of users (e.g., at a school, a community-based organization, or market vendors) handles the O&M by ensuring that a person or a committee is responsible for it on behalf of all users. Shared facilities are defined by the fact that the community of users decides who is allowed to use the facility and what their responsibilities are; it is a self-defined group of users.
- *Public* implies institutional or government run facilities, and all O&M is assumed by the agency operating the facility. Usually, only users who can pay for the service are permitted to use public facilities.

The Composting Chamber in this example can be managed by all three styles, even though it is less suitable for public installations.

The technologies in the functional group User Interface do not include a Management Level since maintenance

is dependent on the subsequent technologies, and not simply on the User Interface.

5 Inputs refers to the products that flow into the given technology.

The icons shown **without parentheses** are the regular inputs that will typically go into a technology. For some technologies, these products represent alternatives or options (possibilities) of which not all are necessary. Hence, the regular icons represent the *mandatory products or choice of mandatory main products*.

Products **in parentheses ()** are *additional (optional) products* that may or may not be used or occur as input products, depending on the design or context.

Where a product occurs *mixed* with another product, this is indicated by the **plus +**. The product following the + is mixed with the preceding product(s). In other words: both of the products on either side of the + are included in the given technology and are mixed together.

In this example, Excreta or Faeces (if the UDDT is used as User Interface) and Organics are the main products that can be processed by the Composting Chamber. Dry Cleansing Materials may also be included (the

parentheses indicate that this is an additional, optional input in case the users are wipers and biodegradable Dry Cleansing Materials are used). Dry Cleansing Materials are not separated from Excreta or Faeces at the User Interface and, therefore, enter the Composting Chamber along with the previous products (indicated by the +). Anal Cleansing Water must *not* be discharged into the Composting Chamber; therefore, it is not listed.

6 Outputs refers to the products that flow out of the given technology.

The icons shown **without parentheses** are the regular outputs that typically come out of a technology.

Products **in parentheses ()** are *additional (optional) products* that may or may not occur as output products, depending on the design or context.

When these products occur *mixed* with another product, this is indicated by the **plus +**. The product following the + is mixed with the preceding product(s). In other words: both of the products on either side of the + emanate from the given technology in a mixed form.

In this example, the Composting Chamber produces two separate products: Compost and Effluent (leachate).





This section describes the technologies with which the user interacts, i.e., the type of toilet, pedestal, pan, or urinal used by the user. The User Interface must guarantee that human excreta is hygienically separated from human contact to prevent exposure to faecal contamination. There are two main types of interfaces: dry technologies that operate without water (U.1-U.3) and water-based technologies that need a regular supply of water to properly function (U.4-U.6). Different User Interface technologies generate different output products. This influences the subsequent type of Collection and Storage/Treatment or Conveyance technology.



- U.1 Dry Toilet
- U.2 Urine-Diverting Dry Toilet (UDDT)
- U.3 Urinal
- U.4 Pour Flush Toilet
- U.5 Cistern Flush Toilet
- U.6 Urine-Diverting Flush Toilet (UDFT)

In any given context, the technology choice generally depends on the following factors:

- Availability of water for flushing
- Habits and preferences of the users (sitting or squatting, washing or wiping)
- Special needs of user groups
- Local availability of materials
- Compatibility with the subsequent Collection and Storage/Treatment or Conveyance technology



Inputs:  Faeces  Urine
( Anal Cleansing Water) ( Dry Cleansing Materials)

Outputs:  Excreta (+  Anal Cleansing Water)
(+  Dry Cleansing Materials)

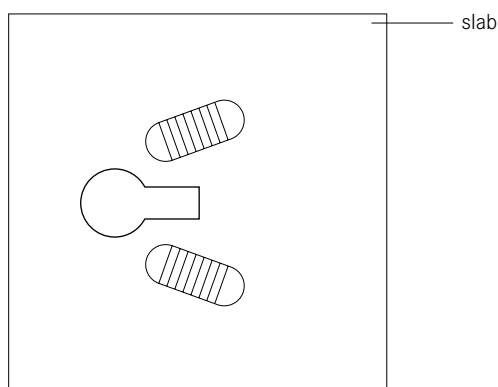

option 1

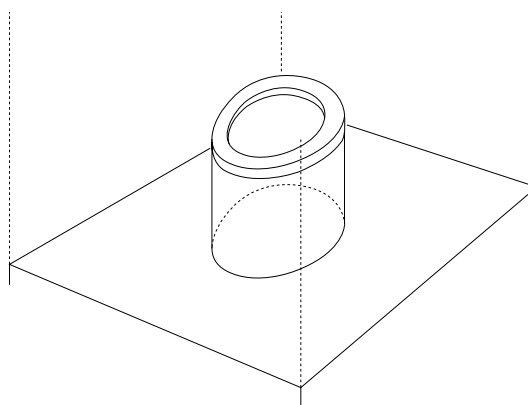

option 2

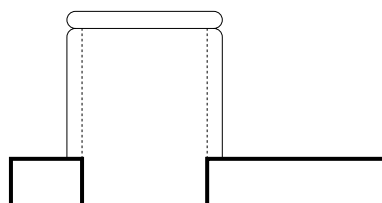

A dry toilet is a toilet that operates without flushwater. The dry toilet may be a raised pedestal on which the user can sit, or a squat pan over which the user squats. In both cases, excreta (both urine and faeces) fall through a drop hole.

In this compendium, a dry toilet refers specifically to the device over which the user sits or squats. In other literature, a dry toilet may refer to a variety of technologies, or combinations of technologies (especially pits).

Design Considerations The dry toilet is usually placed over a pit; if two pits are used, the pedestal or slab should be designed in such a way that it can be lifted and moved from one pit to another.

The slab or pedestal base should be well sized to the pit so that it is both safe for the user and prevents stormwater from infiltrating the pit (which may cause it to overflow). The hole can be closed with a lid to prevent unwanted intrusion from insects or rodents.

Pedestals and squatting slabs can be made locally with concrete (providing that sand and cement are available). Fibreglass, porcelain and stainless steel versions may also be available. Wooden or metal

moulds can be used to produce several units quickly and efficiently.

Appropriateness Dry toilets are easy for almost everyone to use though special consideration may need to be made for elderly or disabled users who may have difficulty. When dry toilets are made locally, they can be specially designed to meet the needs of the target users (e.g., smaller ones for children). Because there is no need to separate urine and faeces, they are often the simplest and physically most comfortable option.

Health Aspects/Acceptance Squatting is a natural position for many people and so a well-kept squatting slab may be the most acceptable option.

Since dry toilets do not have a water seal, odours may be a problem depending on the Collection and Storage/Treatment technology connected to them.

Operation & Maintenance The sitting or standing surface should be kept clean and dry to prevent pathogen/disease transmission and to limit odours.

There are no mechanical parts; therefore, the dry toilet should not need repairs except in the event that it cracks.

Pros & Cons

- + Does not require a constant source of water
- + Can be built and repaired with locally available materials
- + Low capital and operating costs
- + Suitable for all types of users (sitters, squatters, washers, wipers)
- Odours are normally noticeable (even if the vault or pit used to collect excreta is equipped with a vent pipe)
- The excreta pile is visible, except where a deep pit is used
- Vectors such as flies are hard to control unless fly traps and appropriate covers are used

References & Further Reading

- Brandberg, B. (1997). *Latrine Building. A Handbook for Implementation of the Sanplat System*. Intermediate Technology Publications, London, UK. pp. 55-77.
(Describes how to build a squatting slab and the moulds for the frame, footrests, spacers, etc.)
- CAWST (2011). *Introduction to Low Cost Sanitation. Latrine Construction. A CAWST Construction Manual*. Centre for Affordable Water and Sanitation Technologies (CAWST), Calgary, CA.
Available at: www.cawst.org
(Very detailed construction manual for different slab designs)
- Morgan, P. R. (2007). *Toilets That Make Compost. Low-Cost, Sanitary Toilets That Produce Valuable Compost for Crops in an African Context*. Stockholm Environment Institute, Stockholm, SE.
Available at: www.ecosanres.org
(Excellent description of how to make support rings and squatting slabs (pp. 7-35) and pedestals (pp. 39-43) using only sand, cement, plastic sheeting and wire)
- Morgan, P. R. (2009). *Ecological Toilets. Start Simple and Upgrade from Arborloo to VIP*. Stockholm Environment Institute, Stockholm, SE.
Available at: www.ecosanres.org
- Reed, B. (2012). *An Engineer's Guide to Latrine Slabs*. WEDC, Loughborough University, Leicestershire, UK.
Available at: wedc.lboro.ac.uk/knowledge/booklets.html
(Comprehensive guide with key information and checklists for design, construction and maintenance)

Inputs: Faeces (brown square), Urine (yellow square)
(Anal Cleansing Water) (light blue square), (Dry Cleansing Materials) (purple square)

Outputs: Faeces (+ Dry Cleansing Materials) (brown square + purple square)
Urine (yellow square), (Anal Cleansing Water) (light blue square)

for wipers

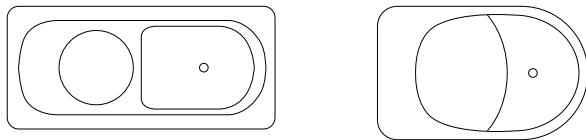

for washers

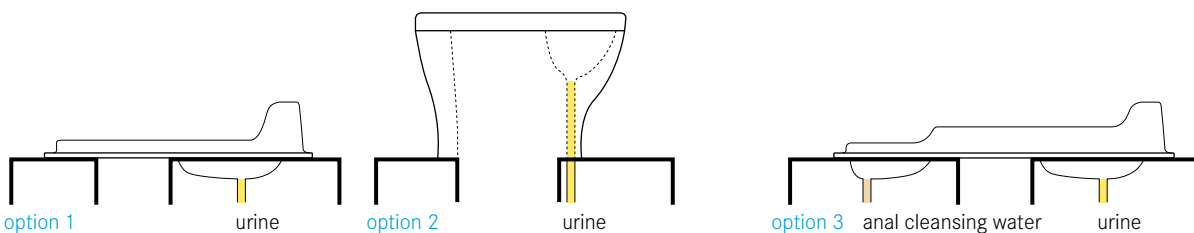
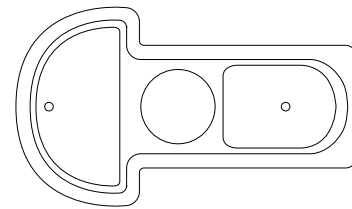

A urine-diverting dry toilet (UDDT) is a toilet that operates without water and has a divider so that the user, with little effort, can divert the urine away from the faeces.

The UDDT is built such that urine is collected and drained from the front area of the toilet, while faeces fall through a large chute (hole) in the back. Depending on the Collection and Storage/Treatment technology that follows, drying material such as lime, ash or earth should be added into the same hole after defecating.

Design Considerations It is important that the two sections of the toilet are well separated to ensure that a) faeces do not fall into and clog the urine collection area in the front, and that b) urine does not splash down into the dry area of the toilet.

There are also 3-hole separating toilets that allow anal cleansing water to go into a third, dedicated basin separate from the urine drain and faeces collection.

Both a pedestal and a squat slab can be used to separate urine from faeces depending on user preference.

Urine tends to rust most metals; therefore, metals should be avoided in the construction and piping of the

UDDT. To limit scaling, all connections (pipes) to storage tanks should be kept as short as possible; whenever they exist, pipes should be installed with at least a 1% slope, and sharp angles (90°) should be avoided. A pipe diameter of 50 mm is sufficient for steep slopes and where maintenance is easy. Larger diameter pipes (> 75 mm) should be used elsewhere, especially for minimum slopes, and where access is difficult.

To prevent odours from coming back up the pipe, an odour seal should be installed at the urine drain.

Appropriateness The UDDT is simple to design and build, using such materials as concrete and wire mesh or plastic. The UDDT design can be altered to suit the needs of specific populations (i.e., smaller for children, people who prefer to squat, etc.).

Health Aspects/Acceptance The UDDT is not intuitive or immediately obvious to some users. At first, users may be hesitant about using it, and mistakes made (e.g., faeces in the urine bowl) may deter others from accepting this type of toilet as well. Demonstration projects and training are essential to achieve good acceptance with users. For better acceptance of the

system and to avoid urine in the faeces collection bowl, the toilet can be combined with a Urinal (U.3), allowing men to stand and urinate.

Operation & Maintenance A UDDT is slightly more difficult to keep clean compared to other toilets because of both the lack of water and the need to separate the solid faeces and liquid urine. No design will work for everyone and, therefore, some users may have difficulty separating both streams perfectly, which may result in extra cleaning and maintenance. Faeces can be accidentally deposited in the urine section, causing blockages and cleaning problems.

All of the surfaces should be cleaned regularly to prevent odours and to minimize the formation of stains. Water should not be poured in the toilet for cleaning. Instead, a damp cloth may be used to wipe down the seat and the inner bowls. Some toilets are easily removable and can be cleaned more thoroughly. It is important that the faeces remain separate and dry. When the toilet is cleaned with water, care should be taken to ensure that the faeces are not mixed with water.

Because urine is collected separately, calcium- and magnesium-based minerals and salts can precipitate and build up in pipes and on surfaces where urine is constantly present. Washing the bowl with a mild acid (e.g., vinegar) and/or hot water can prevent the build-up of mineral deposits and scaling. Stronger (> 24% acetic) acid or a caustic soda solution (2 parts water to 1 part soda) can be used for removing blockages. However, in some cases manual removal may be required.

An odour seal also requires occasional maintenance. It is critical to regularly check its functioning.



Pros & Cons



- + Does not require a constant source of water
- + No real problems with flies or odours if used and maintained correctly
- + Can be built and repaired with locally available materials
- + Low capital and operating costs
- + Suitable for all types of users (sitters, squatters, washers, wipers)

- Prefabricated models not available everywhere
- Requires training and acceptance to be used correctly
- Is prone to misuse and clogging with faeces
- The excreta pile is visible
- Men usually require a separate Urinal for optimum collection of urine

References & Further Reading

- Morgan, P. R. (2007). *Toilets That Make Compost. Low-Cost, Sanitary Toilets That Produce Valuable Compost for Crops in an African Context*. Stockholm Environment Institute, Stockholm, SE.
Available at: www.ecosanres.org
(Provides step-by step instruction on how to build a UDDT using a plastic bucket and how to construct a urine-diverting squat plate)
- Morgan, P. R. (2009). *Ecological Toilets. Start Simple and Upgrade from Arborloo to VIP*. Stockholm Environment Institute, Stockholm, SE.
Available at: www.ecosanres.org
- von Münch, E. and Winker, M. (2011). *Technology Review of Urine Diversion Components. Overview of Urine Diversion Components Such as Waterless Urinals, Urine Diversion Toilets, Urine Storage and Reuse Systems*. Gesellschaft für Internationale Zusammenarbeit (GIZ) GmbH, Eschborn, DE.
Available at: www.susana.org/library
- NWP (2006). *Smart Sanitation Solutions. Examples of Innovative, Low-Cost Technologies for Toilets, Collection, Transportation, Treatment and Use of Sanitation Products*. Netherlands Water Partnership, The Hague, NL.
Available at: www.ircwash.org
- Rieck, C., von Münch, E. and Hoffmann, H. (2012). *Technology Review of Urine-Diverting Dry Toilets (UDDTs). Overview of Design, Operation, Management and Costs*. Deutsche Gesellschaft für Internationale Zusammenarbeit (GIZ) GmbH, Eschborn, DE.
Available at: www.susana.org/library
- Winblad, U. and Simpson-Hébert, M. (Eds.) (2004). *Ecological Sanitation. Revised and Enlarged Edition*. Stockholm Environment Institute, Stockholm, SE.
Available at: www.ecosanres.org

Inputs:  Urine ( Flushwater)

Outputs:  Urine (+  Flushwater)

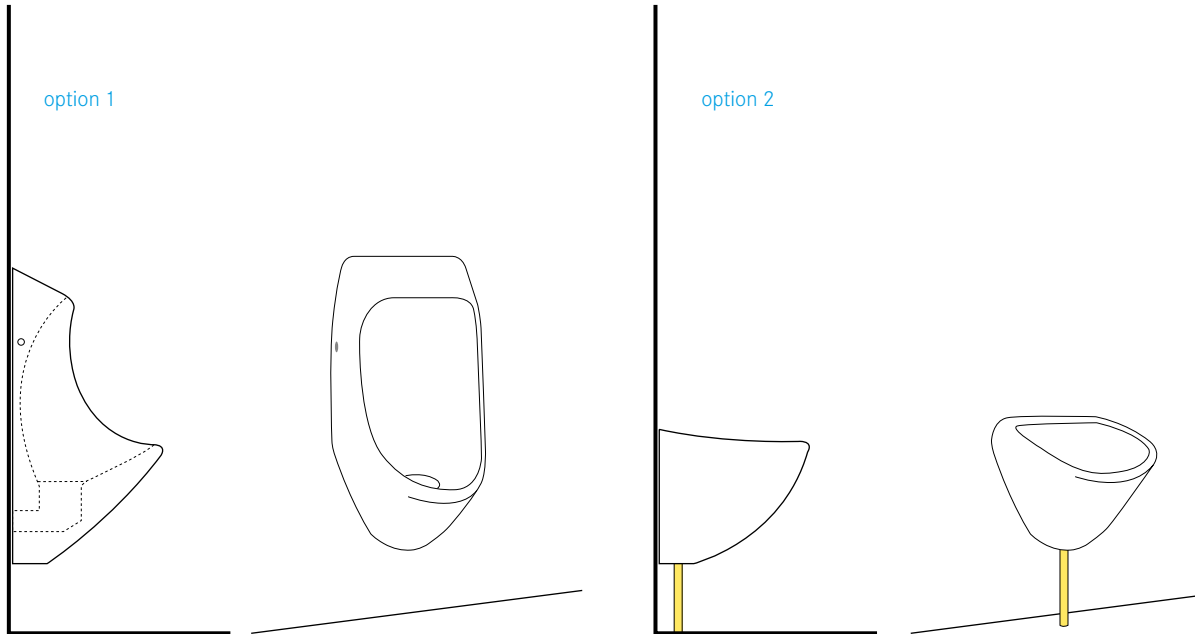

A urinal is used only for collecting urine. Urinals are generally for men, although models for women have also been developed. Most urinals use water for flushing, but waterless urinals are becoming increasingly popular.

Urinals for women consist of raised foot-steps and a sloped channel or catchment area that conducts the urine to a collection technology. For men, urinals can be either vertical wall-mounted units, or squat slabs over which the user squats.

The urinal can be used with or without water and the plumbing can be developed accordingly. If water is used, it is mainly used for cleaning and limiting odours (with a water-seal).

Design Considerations For water-based urinals, the water use per flush ranges from less than 2 L in current designs to almost 20 L of flushwater in outdated models. Water-saving or waterless technologies should be favoured. To minimize odours and nitrogen loss in simple waterless urinal designs, the collection pipe should be submerged in the urine tank to provide a basic liquid seal.

Waterless urinals are available in a range of styles and complexities. Some urinals come equipped with an odour seal that may have a mechanical closure, a membrane, or a sealing liquid.

By putting a small target, or painted fly near the drain, the amount of spraying or splashing can be reduced; this type of user-guidance can help improve the cleanliness of the facility. Because the urinal is exclusively for urine it is important to also provide a toilet to be used for faeces.

Appropriateness Urinals can be used in homes as well as within public facilities. In some cases, the provision of a urinal is useful to prevent the misuse of dry systems (e.g., UDDT, U.2).

Portable waterless urinals have been developed for use at large festivals, concerts and other gatherings, to improve the sanitation facilities and reduce the point load of wastewater discharged at the site. In this way, a large volume of urine can be collected (and either used or discharged at a more appropriate location or time) and the remaining toilets can be reduced in number or used more efficiently.

Health Aspects/Acceptance The urinal is a comfortable and easily accepted User Interface. Although simple in construction and design, urinals can have a large impact on the well-being of a community. When men have access to a urinal, they may urinate less often in public, which reduces unwanted odours and makes women feel more comfortable. Men have generally accepted waterless urinals, as they do not call for any change of behaviour.

Operation & Maintenance Maintenance is simple, but should be done frequently, especially for waterless urinals. All of the surfaces should be cleaned regularly (bowl, slab and wall) to prevent odours and to minimize the formation of stains.

Particularly, in waterless urinals, calcium- and magnesium-based minerals and salts can precipitate and build up in pipes and on surfaces where urine is constantly present. Washing the bowl with a mild acid (e.g., vinegar) and/or hot water can prevent the build-up of mineral deposits and scaling. Stronger (> 24% acetic) acid or a caustic soda solution (2 parts water to 1 part soda) can be used for removing blockages. However, in some cases manual removal may be required.





For waterless urinals, it is critical to regularly check the functioning of the odour seal.

Pros & Cons

- + Waterless urinals do not require a constant source of water
- + Can be built and repaired with locally available materials
- + Low capital and operating costs
- Problems with odours may occur if not used and maintained correctly
- Models for women are not widely available

References & Further Reading

- Austin, A. and Duncker, L. (2002). *Urine-Diversion. Ecological Sanitation Systems in South Africa*. CSIR, Pretoria, ZA. (Directions for making a simple urinal using a 5 L plastic container)
- von Münch, E. and Dahm, P. (2009). *Waterless Urinals: A Proposal to Save Water and Recover Urine Nutrients in Africa*. 34th WEDC International Conference. Addis Ababa, ET. Available at: wedc-knowledge.lboro.ac.uk
- von Münch, E. and Winker, M. (2011). *Technology Review of Urine Diversion Components. Overview of Urine Diversion Components Such as Waterless Urinals, Urine Diversion Toilets, Urine Storage and Reuse Systems*. Gesellschaft für Internationale Zusammenarbeit (GIZ) GmbH, Eschborn, DE. Available at: www.susana.org/library
- NWP (2006). *Smart Sanitation Solutions. Examples of Innovative, Low-Cost Technologies for Toilets, Collection, Transportation, Treatment and Use of Sanitation Products*. Netherlands Water Partnership, The Hague, NL. Available at: www.ircwash.org

Inputs:  Faeces  Urine  Flushwater
( Anal Cleansing Water)( Dry Cleansing Materials)

Outputs:  Blackwater

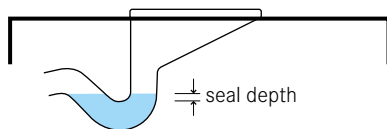
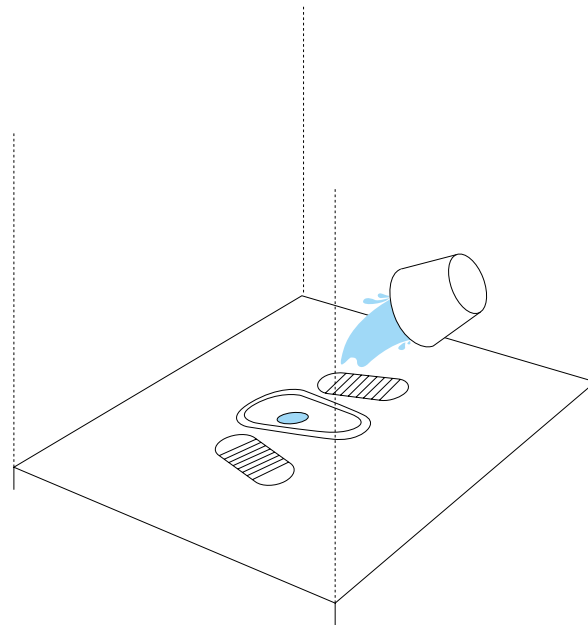
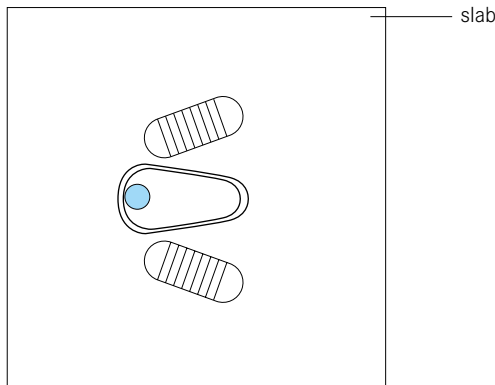

A pour flush toilet is like a regular Cistern Flush Toilet (U.5) except that the water is poured in by the user, instead of coming from the cistern above. When the water supply is not continuous, any Cistern Flush Toilet can become a pour flush toilet.

Just like a Cistern Flush Toilet, the pour flush toilet has a water seal that prevents odours and flies from coming back up the pipe. Water is poured into the bowl to flush the toilet of excreta; approximately 2 to 3 L is usually sufficient. The quantity of water and the force of the water (pouring from a height often helps) must be sufficient to move the excreta up and over the curved water seal.

Both pedestals and squatting pans can be used in the pour flush mode. Due to demand, local manufacturers have become increasingly efficient at mass-producing affordable pour flush toilets and pans.

Design Considerations The water seal at the bottom of the pour flush toilet or pan should have a slope of at least 25°. Water seals should be made out of plastic or ceramic to prevent clogs and to make cleaning easier (concrete may clog more easily if it is rough or textured).

The S-shape of the water seal determines how much water is needed for flushing. The optimal depth of the water seal head is approximately 2 cm to minimize the water required to flush the excreta. The trap should be approximately 7 cm in diameter.

Appropriateness The pour flush toilet is appropriate for those who sit or squat (pedestal or slab), as well as for those who cleanse with water. Yet, it is only appropriate when there is a constant supply of water available. The pour flush toilet requires (much) less water than a traditional Cistern Flush Toilet. However, because a smaller amount of water is used, the pour flush toilet may clog more easily and, thus, require more maintenance.

If water is available, this type of toilet is appropriate for both public and private applications.

Health Aspects/Acceptance The pour flush toilet (or squatting pan) prevents users from seeing or smelling the excreta of previous users. Thus, it is generally well accepted. Provided that the water seal is working well, there should be almost no odours and the toilet should be clean and comfortable to use.





Operation & Maintenance Because there are no mechanical parts, pour flush toilets are quite robust and rarely require repair. Despite the fact that it is a water-based toilet, it should be cleaned regularly to maintain hygiene and prevent the buildup of stains. To reduce water requirements for flushing and to prevent clogging, it is recommended that dry cleansing materials and products used for menstrual hygiene be collected separately and not flushed down the toilet.

Pros & Cons

- + The water seal effectively prevents odours
- + The excreta of one user are flushed away before the next user arrives
- + Suitable for all types of users (sitters, squatters, washers, wipers)
- + Low capital costs; operating costs depend on the price of water
- Requires a constant source of water (can be recycled water and/or collected rainwater)
- Requires materials and skills for production that are not available everywhere
- Coarse dry cleansing materials may clog the water seal

References & Further Reading

- Mara, D. D. (1985). *The Design of Pour-Flush Latrines*. UNDP Interregional Project INT/81/047, The World Bank and UNDP, Washington, D.C., US.
Available at: documents.worldbank.org/curated/en/home
- Mara, D. D. (1996). *Low-Cost Urban Sanitation*. Wiley, Chichester, UK.
(Provides detailed drawings of Indian glass-fibre squat pan and trap with dimensions and critical design criteria. A description of how to modify a pour flush toilet to a cistern flush toilet is included.)
- Roy, A. K., Chatterjee, P. K., Gupta, K. N., Khare, S. T., Rau, B. B. and Singh, R. S. (1984). *Manual on the Design, Construction and Maintenance of Low-Cost Pour-Flush Waterseal Latrines in India*. UNDP Interregional Project INT/81/047, The World Bank and UNDP, Washington, D.C., US.
Available at: documents.worldbank.org/curated/en/home
(Provides specifications for pour flush toilets and connections)

Inputs:  Faeces  Urine  Flushwater
( Anal Cleansing Water)( Dry Cleansing Materials)

Outputs:  Blackwater

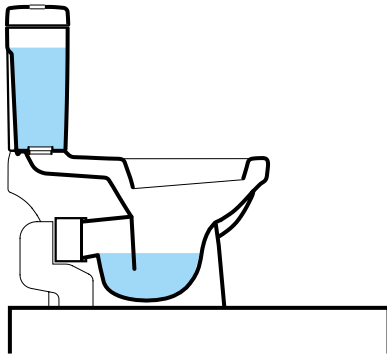
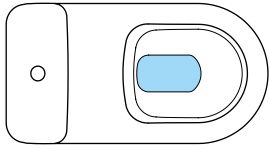

option 1

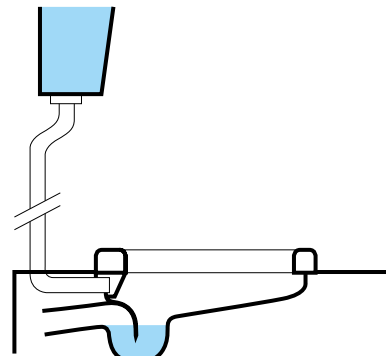
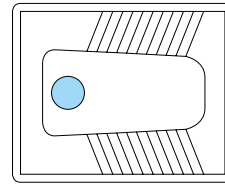

option 2

The cistern flush toilet is usually made of porcelain and is a mass-produced, factory-made User Interface. The flush toilet consists of a water tank that supplies the water for flushing the excreta and a bowl into which the excreta are deposited.

The attractive feature of the cistern flush toilet is that it incorporates a sophisticated water seal to prevent odours from coming back up through the plumbing. Water that is stored in the cistern above the toilet bowl is released by pushing or pulling a lever. This allows the water to run into the bowl, mix with the excreta, and carry them away.

Design Considerations Modern toilets use 6 to 9 L per flush, whereas older models were designed for flushwater quantities of up to 20 L. There are different low-volume flush toilets currently available that can be used with as little as 3 L of water per flush. In some cases, the volume of water used per flush is not sufficient to empty the bowl and, consequently, the user has to flush two or more times to adequately clean the bowl, which negates the intended saving of water.

A good plumber is required to install a flush toilet. The

plumber will ensure that all valves are connected and sealed properly, therefore, minimizing leakage.

Appropriateness A cistern flush toilet should not be considered unless all of the connections and hardware accessories are available locally. The cistern flush toilet must be connected to both a constant source of water for flushing and a Collection and Storage/Treatment or Conveyance technology to receive the blackwater. The cistern flush toilet is suitable for both public and private applications.

Health Aspects/Acceptance It is a safe and comfortable toilet to use provided it is kept clean.







Operation & Maintenance Although flushwater continuously rinses the bowl, the toilet should be scrubbed clean regularly to maintain hygiene and prevent the buildup of stains. Maintenance is required for the replacement or repair of some mechanical parts or fittings. Menstrual hygiene products should be collected in a separate bin.

Pros & Cons

- + The excreta of one user are flushed away before the next user arrives
- + No real problems with odours if used correctly
- + Suitable for all types of users (sitters, squatters, wipers and washers)
- High capital costs; operating costs depend on the price of water
- Requires a constant source of water
- Cannot be built and/or repaired locally with available materials

References & Further Reading

- Maki, B. (2005). *Assembling and Installing a New Toilet*. Hammerzone.com.
Available at: www.hammerzone.com
(Describes how to install a toilet with full colour photos and step-by-step instructions)
- Vandervort, D. (2007). *Toilets: Installation and Repair*. HomeTips.com.
Available at: www.hometips.com/bathroom_toilets.html
(Describes each part of the toilet in detail and provides links to other tools, such as how to install a toilet, how to fix a leaking toilet and other toilet essentials)

	Inputs:  Faeces  Urine  Flushwater  Anal Cleansing Water)  Dry Cleansing Materials)
	Outputs:  Brownwater  Urine

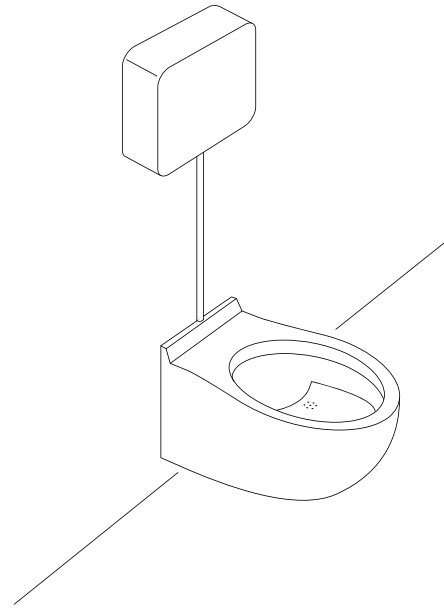
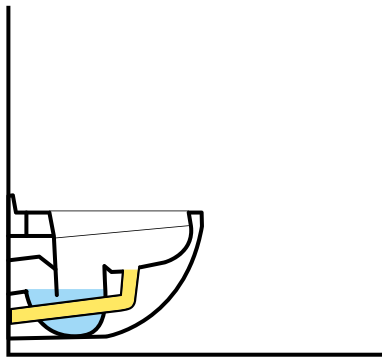
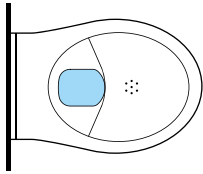

The urine-diverting flush toilet (UDFT) is similar in appearance to a Cistern Flush Toilet (U.5) except for the diversion in the bowl. The toilet bowl has two sections so that the urine can be separated from the faeces. Both sitting and squatting models exist.

Urine is collected in a drain in the front of the toilet and faeces are collected in the back. The urine is collected without water, but a small amount of water is used to rinse the urine-collection bowl when the toilet is flushed. The urine flows into a storage tank for further use or processing, while the faeces are flushed with water to be treated.

Design Considerations The system requires dual plumbing, i.e., separate piping for urine and brownwater (faeces, dry cleansing material and flushing water). The toilet should be installed carefully with an understanding of how and where clogs may occur so that they can be prevented and easily removed. For the discharge of urine, plastic pipes should be used to prevent corrosion. To limit scaling, all connections (pipes) to storage tanks should be kept as short as possible; whenever they exist, pipes should be installed with at least a 1%

slope, and sharp angles (90°) should be avoided. A pipe diameter of 50 mm is sufficient for steep slopes and where maintenance is easy. Larger diameter pipes (> 75 mm) should be used elsewhere, especially for minimum slopes, and where access is difficult.

Appropriateness A UDFT is adequate when there is enough water for flushing, a treatment technology for the brownwater and a use for the collected urine. To improve diversion efficiency, Urinals (U.3) for men are recommended.

UDFTs are suitable for public and private applications, although significant training and awareness is required in public settings to ensure proper use and minimize clogging.

Since this technology requires separate pipes for urine and brownwater collection, the plumbing is more complicated than for Cistern Flush Toilets. Particularly, the proper design and installation of the urine pipes is crucial, and requires expertise.

Health Aspects/Acceptance Information cards and/or diagrams are essential for ensuring proper use and for promoting acceptance; if users understand why

the urine is being separated, they will be more willing to use the UDFT properly. Correct plumbing will ensure that there are no odours.

Operation & Maintenance As with any toilet, proper cleaning is important to keep the bowl(s) clean and prevent stains from forming. Because urine is collected separately, calcium- and magnesium-based minerals and salts can precipitate and build up in the fittings and pipes. Washing the bowl with a mild acid (e.g., vinegar) and/or hot water can prevent the build-up of mineral deposits and scaling. Stronger (> 24% acetic) acid or a caustic soda solution (2 parts water to 1 part soda) can be used for removing blockages. However, in some cases manual removal may be required.

Pros & Cons

- + Requires less water than a traditional Cistern Flush Toilet
- + No real problems with odours if used correctly
- + Looks like, and can be used almost like, a Cistern Flush Toilet
- Limited availability; cannot be built or repaired locally
- High capital costs; operating costs depend on parts and maintenance
- Labour-intensive maintenance
- Requires training and acceptance to be used correctly
- Is prone to misuse and clogging
- Requires a constant source of water
- Men usually require a separate Urinal for optimum collection of urine

References & Further Reading

- Kvarnström, E., Emilsson, K., Richert Stintzing, A., Johansson, M., Jönsson, H., af Petersens, E., Schöningg, C., Christensen, J., Hellström, D., Qvarnström, L., Ridderstolpe, P. and Drangert, J.-O. (2006). *Urine Diversion: One Step Towards Sustainable Sanitation*. Report 2006-1, EcoSanRes: Ecosan Publications Series, Stockholm, SE. Available at: www.ecosanres.org
- Larsen, T. A. and Lienert, J. (2007). *Novaquatis Final Report. NoMix – A New Approach to Urban Water Management*. Eawag, Dübendorf, CH. Available at: www.novaquatis.eawag.ch
- von Münch, E. and Winker, M. (2011). *Technology Review of Urine Diversion Components. Overview of Urine Diversion Components Such as Waterless Urinals, Urine Diversion Toilets, Urine Storage and Reuse Systems*. Gesellschaft für Internationale Zusammenarbeit (GIZ) GmbH, Eschborn, DE. Available at: www.susana.org/library
- Winker, M. and Saadoun, A. (2011). *Urine and Brownwater Separation at GTZ Main Office Building Eschborn, Germany – Case Study of Sustainable Sanitation Projects*. Sustainable Sanitation Alliance (SuSanA), Eschborn, DE. Available at: www.susana.org/library



This section describes the technologies that collect and store the products generated at the User Interface. Some of the technologies presented here are specifically designed for treatment, while others are specifically designed for collection and storage. The latter also provide some degree of treatment, depending on the storage time and conditions. The treatment provided by S technologies is usually passive (e.g., requiring no energy input). Four of the featured technologies are alternating pit/vault technologies (S.4-S.7). Because of the storage period implicit in the design of these technologies, there is a reduced threat of contamination. Therefore, they can be manually emptied.

- S.1 Urine Storage Tank/Container
- S.2 Single Pit
- S.3 Single Ventilated Improved Pit (VIP)
- S.4 Double Ventilated Improved Pit (VIP)
- S.5 Fossa Alterna
- S.6 Twin Pits for Pour Flush
- S.7 Dehydration Vaults
- S.8 Composting Chamber
- S.9 Septic Tank
- S.10 Anaerobic Baffled Reactor (ABR)
- S.11 Anaerobic Filter
- S.12 Biogas Reactor

In any given context, the technology choice generally depends on the following factors:

- Availability of space
- Soil and groundwater characteristics
- Type and quantity of input products
- Local availability of materials
- Desired output products
- Availability of technologies for subsequent transport
- Financial resources
- Management considerations
- User preferences



Application Level:	Management Level:	Inputs:  Urine
<input checked="" type="checkbox"/> Household <input checked="" type="checkbox"/> Neighbourhood <input type="checkbox"/> City	<input checked="" type="checkbox"/> Household <input checked="" type="checkbox"/> Shared <input checked="" type="checkbox"/> Public	Outputs:  Stored Urine

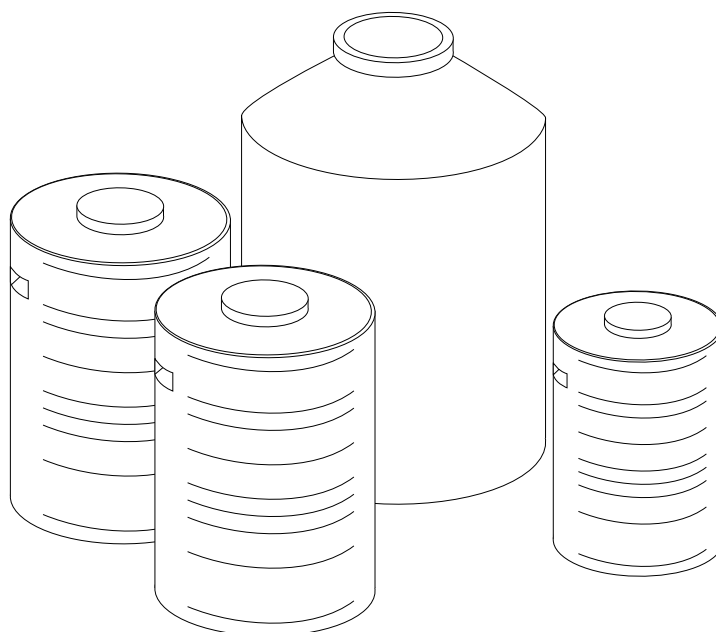

When urine cannot be used immediately or transported using a Conveyance technology (i.e., Jerry-cans, see C.1), it can be stored onsite in containers or tanks. The storage tank must then be moved or emptied into another container for transport.

The urine storage tank should be appropriately sized to accommodate the number of users and the time required to sanitize the urine. The storage guidelines for urine correspond to the temperature of storage and the intended crop for which it would be used as fertilizer, but all urine should be stored for at least 1 month before use (see WHO guidelines for specific storage and application guidelines). If a family's urine is used to fertilize crops for their own household consumption only, it can be used directly without storage.

Smaller volume storage tanks can be used and transported to another centralized storage tank at, or close to, the point of use (i.e., the farm).

Design Considerations On average, a person generates about 1.2 L of urine a day; however, this quantity may vary significantly depending on the climate and fluid consumption. Mobile storage tanks should be

made of plastic or fibreglass, but permanent ones can be comprised of concrete or plastic. Metal should be avoided as it can easily be corroded by the high pH of stored urine.

Over time, a layer of organic sludge and precipitated minerals (primarily calcium and magnesium phosphates) will form on the bottom of the tank. Any tank used for urine storage should have an opening large enough so that it can be cleaned and/or pumped out.

Neither the storage tank, nor the collection pipes should be ventilated to avoid odorous ammonia emissions, but they both need to be pressure equalized.

If the storage tank is directly connected with a pipe to the toilet or urinal, care should be taken to minimize the length of the pipe since precipitates will accumulate. Pipes should have a steep slope (> 1%), no sharp angles, and large diameters (up to 110 mm for underground pipes). They should be easily accessible in case of blockages.

To minimize odours and nitrogen loss, the tank should be filled from the bottom, i.e., the urine should flow down through a pipe and be released near the bottom of the tank. This will prevent the urine from spraying and avoid the backflow of air.

Appropriateness Urine storage tanks are most appropriate where there is a need for nutrients from fertilizer for agriculture which can be supplied by the stored urine. When there is no such need, the urine can become a source of pollution and a nuisance.

Urine storage tanks can be used in virtually every environment; tanks should be well-sealed to prevent leaks, infiltration and nitrogen loss. Urine storage tanks can be installed indoors, outdoors, above ground and below ground depending on the climate, space available, and soil.

Health Aspects/Acceptance Long-term storage is the best way to sanitize urine without the addition of chemicals or mechanical processes. The risk of disease transmission from stored urine is low. Extended storage with storage times greater than 6 months provides near complete sanitization.

Operation & Maintenance If the storage tank is emptied using a vacuum truck (see C.3), the inflow of air must be maintained at a sufficient rate to ensure that the tank does not implode due to the vacuum. A viscous sludge will accumulate on the bottom of the storage tank. When the storage tank is emptied, the sludge will usually be emptied along with the urine, but if a tap is used and the tank is never fully emptied, it may require desludging. The desludging period will depend on the composition of the urine and the storage conditions.

Mineral and salt build-up in the tank or in connecting pipes can be manually removed (sometimes with difficulty) or dissolved with a strong acid (24% acetic).

Pros & Cons

- + Simple and robust technology
- + Can be built and repaired with locally available materials
- + Low risk of pathogen transmission
- + Stored urine can be used as a fertilizer
- + Small land area required
- + No or low operating costs if self-emptied
- Mild to strong odour when opening and emptying tank
- Capital costs can be high (depending on the size and material of the tank)
- May require frequent emptying (depending on tank size)

References & Further Reading





- Kvarnström, E., Emilsson, K., Richert Stintzing, A., Johansson, M., Jönsson, H., af Petersens, E., Schönning, C., Christensen, J., Hellström, D., Qvarnström, L., Ridderstolpe, P. and Drangert, J.-O. (2006). *Urine Diversion: One Step Towards Sustainable Sanitation*. Report 2006-1, EcoSanRes: Ecosan Publications Series, Stockholm, SE. Available at: www.ecosanres.org
- von Münch, E. and Winker, M. (2011). *Technology Review of Urine Diversion Components. Overview of Urine Diversion Components Such as Waterless Urinals, Urine Diversion Toilets, Urine Storage and Reuse Systems*. Gesellschaft für Internationale Zusammenarbeit (GIZ) GmbH, Eschborn, DE. Available at: www.susana.org/library
- WHO (2006). *Guidelines for the Safe Use of Wastewater, Excreta and Greywater. Volume 4: Excreta and Greywater Use in Agriculture*. World Health Organization, Geneva, CH. Available at: www.who.int

Application Level:

- Household
- Neighbourhood
- City

Management Level:

- Household
- Shared
- Public

Inputs:  Excreta  Blackwater  Faeces
(+  Anal Cleansing Water) (+  Dry Cleansing Materials)

Outputs:  Sludge

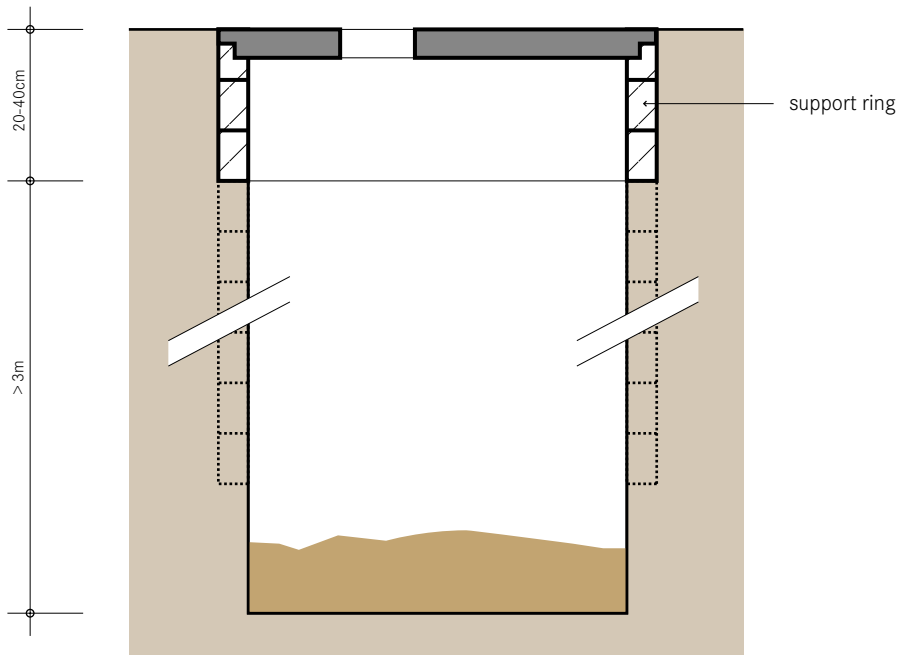

The single pit is one of the most widely used sanitation technologies. Excreta, along with anal cleansing materials (water or solids) are deposited into a pit. Lining the pit prevents it from collapsing and provides support to the superstructure.

As the single pit fills, two processes limit the rate of accumulation: leaching and degradation. Urine and water percolate into the soil through the bottom of the pit and wall, while microbial action degrades part of the organic fraction.

Design Considerations On average, solids accumulate at a rate of 40 to 60 L per person/year and up to 90 L per person/year if dry cleansing materials such as leaves or paper are used. The volume of the pit should be designed to contain at least 1,000 L. Typically, the pit is at least 3 m deep and 1 m in diameter. If the pit diameter exceeds 1.5 m, there is an increased risk of collapse. Depending on how deep they are dug, some pits may last 20 or more years without emptying. To prevent groundwater contamination, the bottom of the pit should be at least 2 m above groundwater level (rule of thumb). If the pit is to be reused, it should be lined.

Pit lining materials can include brick, rot-resistant timber, concrete, stones, or mortar plastered onto the soil. If the soil is stable (i.e., no presence of sand or gravel deposits or loose organic materials), the whole pit need not be lined. The bottom of the pit should remain unlined to allow for the infiltration of liquids out of the pit.

As liquid leaches from the pit and migrates through the unsaturated soil matrix, pathogenic germs are sorbed to the soil surface. In this way, pathogens can be removed prior to contact with groundwater. The degree of removal varies with soil type, distance travelled, moisture and other environmental factors and, thus, it is difficult to estimate the distance necessary between a pit and a water source. A minimum horizontal distance of 30 m is normally recommended to limit exposure to microbial contamination.

When it is not possible to dig a deep pit or the groundwater level is too high, a raised pit can be a viable alternative: the shallow pit can be extended by building the pit upwards with the use of concrete rings or blocks. A raised pit can also be constructed in an area where flooding is frequent in order to keep water from flowing into the pit during heavy rain. Another variation is the unlined shallow pit that may be appropriate for areas

where digging is difficult. When the shallow pit is full, it can be covered with leaves and soil, and a small tree can be planted (see Arborloo, D.1).

A Ventilated Improved Pit (VIP, S.3) is slightly more expensive than a single pit, but greatly reduces the nuisance of flies and odours, while increasing comfort.

If a urine-diverting User Interface is used, only faeces are collected in the pit and leaching can be minimized.

Appropriateness Treatment processes in a single pit (aerobic, anaerobic, dehydration, composting or otherwise) are limited and, therefore, pathogen reduction and organic degradation is not significant. However, since the excreta are contained, pathogen transmission to the user is limited.

Single pits are appropriate for rural and peri-urban areas; in densely populated areas they are often difficult to empty and/or have insufficient space for infiltration. Single pits are especially appropriate when water is scarce and where there is a low groundwater table. They are not suited for rocky or compacted soils (that are difficult to dig), or for areas that flood frequently.

Health Aspects/Acceptance A single pit is an improvement to open defecation; however, it still poses health risks:

- Leachate can contaminate groundwater;
- Stagnant water in pits may promote insect breeding;
- Pits are susceptible to failure and/or overflowing during floods.

Single pits should be constructed at an appropriate distance from homes to minimize fly and odour nuisances and to ensure convenience and safety.







Operation & Maintenance There is no daily maintenance associated with a single pit apart from keeping the facility clean. However, when the pit is full it can be a) pumped out and reused or b) the superstructure and squatting plate can be moved to a new pit and the previous pit covered and decommissioned, which is only advisable if plenty of land area is available.

Pros & Cons

- + Can be built and repaired with locally available materials
- + Low (but variable) capital costs depending on materials and pit depth
- + Small land area required
- Flies and odours are normally noticeable
- Low reduction in BOD and pathogens with possible contamination of groundwater
- Costs to empty may be significant compared to capital costs
- Sludge requires secondary treatment and/or appropriate discharge

References & Further Reading

- ARGOSS (2001). *Guidelines for Assessing the Risk to Groundwater from on-Site Sanitation*. British Geological Survey Commissioned Report, CR/01/142, Keyworth, UK. Available at: www.bgs.ac.uk
- Brandberg, B. (1997). *Latrine Building. A Handbook for Implementation of the Sanplat System*. Intermediate Technology Publications, London, UK. (A good summary of common construction problems and how to avoid mistakes)
- Franceys, R., Pickford, J. and Reed, R. (1992). *A Guide to the Development of on-Site Sanitation*. WHO, Geneva, CH. Available at: www.susana.org/library (For information on accumulation rates, infiltration rates, general construction and example design calculations)
- Graham, J. P. and Polizzotto, M. L. (2013). *Pit Latrines and Their Impacts on Groundwater Quality: A Systematic Review*. Environmental Health Perspectives, National Institute of Environmental Health Sciences, Research Triangle Park, US. Available at: www.ehponline.org
- Pickford, J. (1995). *Low Cost Sanitation. A Survey of Practical Experience*. Intermediate Technology Publications, London, UK. (Information on how to calculate pit size and technology life)
- Robens Institute (1996). *Fact Sheets on Environmental Sanitation. Fact Sheet 3.4: Simple Pit Latrines*. University of Surrey, UK and WHO, Geneva, CH. Available at: www.who.int

Application Level:	Management Level:	Inputs:  Excreta  Blackwater  Faeces
		(+  Anal Cleansing Water) (+  Dry Cleansing Materials)
<input checked="" type="checkbox"/> Household	<input checked="" type="checkbox"/> Household	Outputs:  Sludge
<input checked="" type="checkbox"/> Neighbourhood	<input checked="" type="checkbox"/> Shared	
<input type="checkbox"/> City	<input checked="" type="checkbox"/> Public	

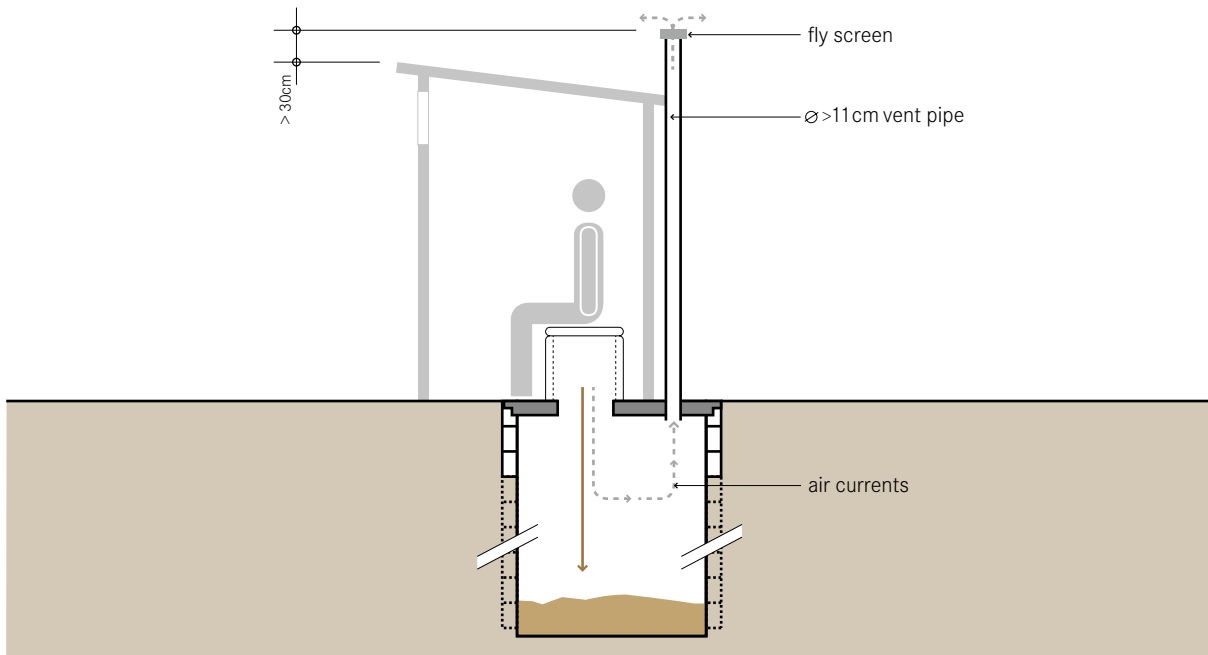

The single VIP is a ventilated improved pit. It is an improvement over the Single Pit (S.2) because continuous airflow through the ventilation pipe vents odours and acts as a trap for flies as they escape towards the light.

Despite their simplicity, well-designed single VIPs can be completely smell free, and more pleasant to use than some other water-based technologies.

Flies that hatch in the pit are attracted to the light at the top of the ventilation pipe. When they fly towards the light and try to escape, they are trapped by the fly-screen and die. The ventilation also allows odours to escape and minimizes the attraction for flies.

Design Considerations The vent pipe should have an internal diameter of at least 110 mm and reach more than 300 mm above the highest point of the toilet superstructure. Wind passing over the top creates a suction pressure within the vent pipe and induces an air circulation. Air is drawn through the User Interface into the pit, moves up inside the vent pipe and escapes into the atmosphere. Care should be taken that objects, such as trees or houses, do not interfere with the air

stream. The vent works best in windy areas, but where there is little wind, its effectiveness can be improved by painting the pipe black. The heat difference between the pit (cool) and the vent (warm) creates an updraft that pulls the air and odours up and out of the pit. To test the efficacy of the ventilation, a lit cigarette can be held over the User Interface; the smoke should be pulled down into the pit and up into the vent and not remain in the superstructure.

The mesh size of the fly screen must be large enough to prevent clogging with dust and allow air to circulate freely. Aluminium screens, with a hole-size of 1.2 to 1.5 mm, have proven to be the most effective. Typically, the pit is at least 3 m deep and 1 to 1.5 m in diameter, depending on the number of users. Deep pits can last up to 20 or more years.

As liquid leaches from the pit and migrates through the unsaturated soil matrix, pathogenic germs are sorbed to the soil surface. In this way, pathogens can be removed prior to contact with groundwater. The degree of removal varies with soil type, distance travelled, moisture and other environmental factors and, thus, it is difficult to estimate the distance necessary between a pit and a water source. A minimum horizontal distance of 30 m

between a pit and a water source and 2 m between the bottom of the pit and the groundwater table is normally recommended to limit exposure to microbial contamination.

When it is not possible to dig a deep pit or the groundwater level is too high, a raised pit can be a viable alternative: the shallow pit can be extended by building the pit upwards with the use of concrete rings or blocks. A raised pit can also be constructed in an area where flooding is frequent in order to keep water from flowing into the pit during heavy rain.

A single VIP toilet can be upgraded to a Double VIP (S.4). A Double VIP has an extra pit so that while one is in use, the contents of the full pit are allowed to drain, mature and degrade.

If a urine-diverting User Interface is used, only faeces are collected in the pit and leaching can be minimized.

Appropriateness Treatment processes in the single VIP (aerobic, anaerobic, dehydration, composting, or otherwise) are limited, and, therefore, pathogen reduction and organic degradation is not significant. However, since the excreta are contained, pathogen transmission to the user is limited. This technology is a significant improvement over Single Pits or open defecation.

Single VIPs are appropriate for rural and peri-urban areas; in densely populated areas they are often difficult to empty and/or have insufficient space for infiltration. VIPs are especially appropriate when water is scarce and where there is a low groundwater table. They should be located in an area with a good breeze to ensure effective ventilation. They are not suited for rocky or compacted soils (that are difficult to dig) or for areas that flood frequently.

Health Aspects/Acceptance A single VIP can be a very clean, comfortable, and well accepted sanitation option. However, some health concerns exist:

- Leachate can contaminate groundwater;
- Pits are susceptible to failure and/or overflowing during floods;
- Health risks from flies are not completely removed by ventilation.

Operation & Maintenance To keep the single VIP free of flies and odours, regular cleaning and maintenance is required. Dead flies, spider webs, dust and other debris should be removed from the ventilation screen to ensure a good flow of air.

Pros & Cons

- + Flies and odours are significantly reduced (compared to non-ventilated pits)
- + Can be built and repaired with locally available materials
- + Low (but variable) capital costs depending on materials and pit depth
- + Small land area required
- Low reduction in BOD and pathogens with possible contamination of groundwater
- Costs to empty may be significant compared to capital costs
- Sludge requires secondary treatment and/or appropriate discharge

References & Further Reading

- Mara, D. D. (1984). *The Design of Ventilated Improved Pit Latrines*. UNDP Interregional Project INT/81/047, The World Bank and UNDP, Washington, D.C., US. Available at: documents.worldbank.org/curated/en/home
- Mara, D. D. (1996). *Low-Cost Urban Sanitation*. Wiley, Chichester, UK. (Provides detailed design information)
- Morgan, P. R. (2009). *Ecological Toilets. Start Simple and Upgrade from Arborloo to VIP*. Stockholm Environment Institute, Stockholm, SE. Available at: www.ecosanres.org
- Morgan, P. R. (2011). *The Blair VIP toilet. Manual for Upgradeable BVIP Model with Spiral Superstructure and Tubular Vent*. Stockholm Environment Institute, Stockholm, SE. Available at: www.ecosanres.org (Provides detailed design and construction information)
- Ryan, B. A. and Mara, D. D. (1983). *Ventilated Improved Pit Latrines: Vent Pipe Design Guidelines*. UNDP Interregional Project INT/81/047, The World Bank and UNDP, Washington, D.C., US. Available at: documents.worldbank.org/curated/en/home See S.2 for additional reading materials.

Application Level:

- Household
- Neighbourhood
- City

Management Level:

- Household
- Shared
- Public

Inputs:

Excreta Faeces
 (+ Anal Cleansing Water) (+ Dry Cleansing Materials)

Outputs:

Pit Humus

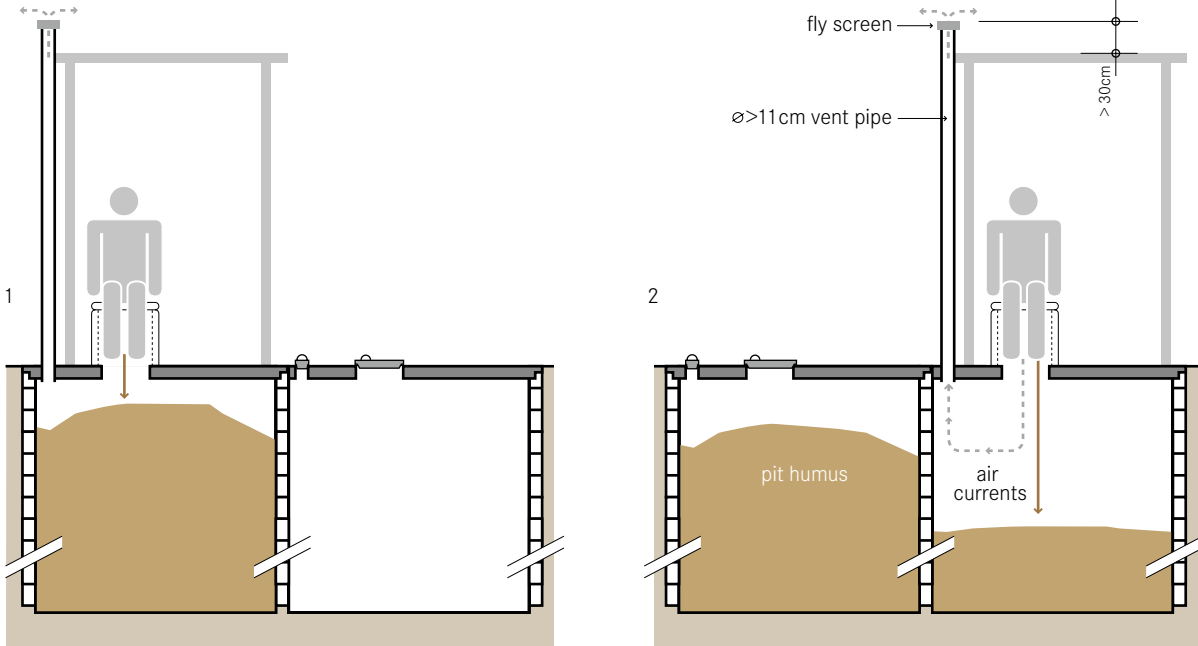

The double VIP has almost the same design as the Single VIP (S.3) with the added advantage of a second pit that allows it to be used continuously and permits safer and easier emptying.

By using two pits, one pit can be used, while the content of the second rests, drains, reduces in volume, and degrades. When the second pit is almost full (the excreta is 50 cm from the top of the pit), it is covered, and the content of the first pit is removed. Due to the extended resting time (at least 1 or 2 years after several years of filling), the material within the pit is partially sanitized and humus-like.

Design Considerations The superstructure may either extend over both holes or it may be designed to move from one pit to the other. In either case, the pit that is not being filled should be fully covered and sealed to prevent water, garbage and animals, or people from falling into the pit. The ventilation of the two pits can be accomplished using one ventilation pipe moved back and forth between the pits, or each pit can be equipped with its own dedicated pipe. The two pits in the double VIP are continually used

and should be well lined and supported to ensure longevity.

Appropriateness The double VIP is more appropriate than the Single VIP for denser, peri-urban areas. After the resting time, the soil-like material is manually emptied (it is dug out, not pumped out), so vacuum truck access to the pits is not necessary.

The double VIP technology will only work properly if the two pits are used sequentially and not concurrently. Therefore, an adequate cover for the out of service pit is required. Double VIPs are especially appropriate when water is scarce and where there is a low groundwater table. They should be located in an area with a good breeze to allow for proper ventilation. They are not suited for rocky or compacted soils (that are difficult to dig) or for areas that flood frequently.

Health Aspects/Acceptance The double VIP can be a very clean, comfortable and well accepted sanitation option, in some cases even more so than a water-based technology. However, some health concerns exist:

- Leachate can contaminate groundwater;
- Pits are susceptible to failure and/or overflowing during floods;
- Health risks from flies are not completely removed by ventilation.

Operation & Maintenance To keep the double VIP free of flies and odours, regular cleaning and maintenance is required. Dead flies, spider webs, dust and other debris should be removed from the ventilation screen to ensure a good flow of air. The out of service pit should be well sealed to reduce water infiltration and a proper alternating schedule must be maintained.

Pros & Cons

- + Longer life than Single VIP (indefinite if maintained properly)
- + Excavation of humus is easier than faecal sludge
- + Significant reduction in pathogens
- + Potential for use of stored faecal material as soil conditioner
- + Flies and odours are significantly reduced (compared to non-ventilated pits)
- + Can be built and repaired with locally available materials
- Manual removal of humus is required
- Possible contamination of groundwater
- Higher capital costs than Single VIP; but reduced operating costs if self-emptied

References & Further Reading

- ARGOSS (2001). *Guidelines for Assessing the Risk to Groundwater from on-Site Sanitation*. British Geological Survey Commissioned Report, CR/01/142, Keyworth, UK. Available at: www.bgs.ac.uk
- Franceys, R., Pickford, J. and Reed, R. (1992). *A Guide to the Development of on-Site Sanitation*. WHO, Geneva, CH. Available at: www.susana.org/library
- Graham, J. P. and Polizzotto, M. L. (2013). *Pit Latrines and Their Impacts on Groundwater Quality: A Systematic Review*. Environmental Health Perspectives, National Institute of Environmental Health Sciences, Research Triangle Park, US. Available at: www.ehponline.org
- Mara, D. D. (1984). *The Design of Ventilated Improved Pit Latrines*. UNDP Interregional Project INT/81/047, The World Bank and UNDP, Washington, D.C., US. Available at: documents.worldbank.org/curated/en/home (A good reference for detailed double VIP design information)
- Mara, D. D. (1996). *Low-Cost Urban Sanitation*. Wiley, Chichester, UK. (General description of VIPs with a focus on the ventilation system)
- Morgan, P. R. (2009). *Ecological Toilets. Start Simple and Upgrade from Arborloo to VIP*. Stockholm Environment Institute, Stockholm, SE. Available at: www.ecosanres.org

Application Level:

- ★★ Household
- ★ Neighbourhood
- City

Management Level:

- ★★ Household
- ★★ Shared
- ★ Public

Inputs: Excreta Faeces Organics
(+ Anal Cleansing Water) (+ Dry Cleansing Materials)

Outputs: Pit Humus

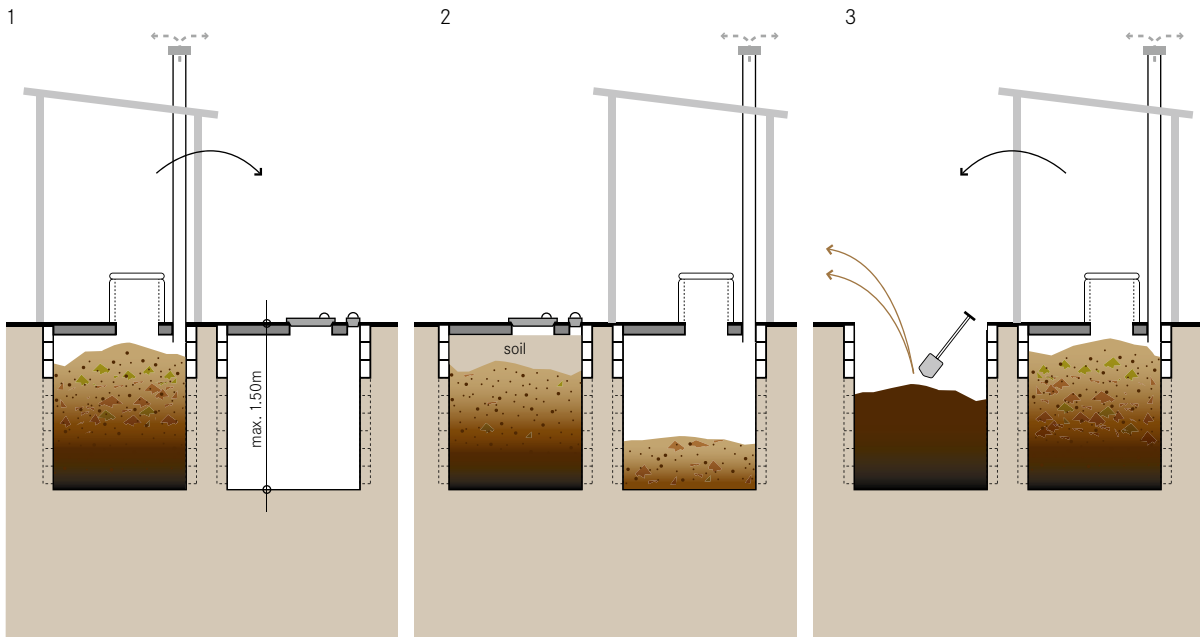

The Fossa Alterna is a short cycle alternating, waterless (dry) double pit technology. Compared to the Double VIP (S.4) which is just designed to collect, store and partially treat excreta, the Fossa Alterna is designed to make an earth-like product that can be used as a nutrient-rich soil conditioner. The Fossa Alterna is dug to a maximum depth of 1.5 m and requires a constant input of cover material (soil, ash, and/or leaves).

Cover material should be added to the pit after defecation (not urination). The soil and leaves introduce a variety of organisms like worms, fungi and bacteria which help in the degradation process. Also, the pore space is increased, which allows for aerobic conditions. Additionally, ash helps to control flies, reduces odours and makes the mix slightly more alkaline.

The full pit degrades while the second pit is filling, which, ideally, should take one year. The material in the full pit will degrade into a dry, earth-like mixture that can be easily removed manually. Because of the added carbon-rich bulking material, the degradation process is accelerated, and the content is ready for excavation and use much faster than in a Double VIP.

Design Considerations A Fossa Alterna pit would fill over a period of 12 to 24 months depending on its size and the number of users. Even though the pits are shallow (1 to 1.5 m), each of them can be used by a family of six for one year. The Fossa Alterna technology will only work properly if the two pits are used sequentially and not concurrently. Therefore, an adequate cover for the out of service pit is required.

The Fossa Alterna should be used for urine, but water should not be added (small amounts of anal cleansing water can be tolerated). Water encourages the development of vectors and pathogens, but it also fills the pore spaces and deprives the aerobic bacteria of the oxygen that is required for degradation. A UDDT (U.2) can be used with the Fossa Alterna, but only in circumstances when the soil cannot sufficiently absorb the urine or when the urine is highly valued for application. Since cover material is used to continuously cover the excreta, smells are reduced. To reduce the smells even further, a ventilation pipe can be added.

In flood-prone areas and where the groundwater table is too high, the Fossa Alterna could be raised or built entirely above ground to avoid water intrusion and groundwater pollution. Raising the pits could also be an

option for rocky ground and compacted soils that are difficult to dig.

If space is abundant and emptying not desired, the Arborloo (D.1) can be an alternative Disposal option. Pits should not be lined if used as an Arborloo.

Appropriateness The Fossa Alterna is appropriate for rural and peri-urban areas. It is especially suitable for water-scarce environments. It is a useful solution for areas that have poor soil and could benefit from the use of the stabilized humic material as a soil amendment. The Fossa Alterna is not appropriate for greywater as the pit is shallow and the conditions must remain aerobic for degradation.

The material is manually emptied from the Fossa Alterna (it is dug out, not pumped out); thus, vacuum truck access to the pits is not necessary.

The Fossa Alterna is not suited for rocky or compacted soils (that are difficult to dig) or for areas that flood frequently, except if the pits are raised.

Health Aspects/Acceptance By covering faeces with soil, ash, and/or leaves, flies and odours are kept to a minimum. Users may not understand the difference between the Fossa Alterna and a Double VIP, although if given the opportunity to use one, people should have a good appreciation of the advantages. Demonstration units can be used to show how easily one can empty a Fossa Alterna in comparison to emptying a double pit. Keeping the contents sealed in the pit for the duration of at least one year makes the material safer and easier to handle. The same precautions that are taken when handling compost should be taken with the humus derived from the Fossa Alterna.

Operation & Maintenance When the first pit is put into use, a layer of leaves should be put onto the bottom of the pit. Periodically, more leaves should be added to increase the porosity and oxygen availability. Following the addition of faeces to the pit, a small amount of soil, ash, and/or leaves should be added. Occasionally, the mounded material beneath the toilet hole should be pushed to the sides of the pit in order to optimise the use of space.

Unlike a Single or Ventilated Pit (S.2, S.3) which will be covered or emptied, the material in the Fossa Alterna is meant to be used as a soil conditioner. Therefore, it is extremely important that no garbage is put into the pit.



Emptying the Fossa Alterna is easier than emptying other pits; the pits are shallower and the addition of soil, ash, and/or leaves means that the contents are less compact. The material that is removed is not offensive and presents a reduced threat of contamination. Depending on the dimensions of the pits, the contents should not be emptied more often than once a year.

Pros & Cons

- + Because double pits are used alternately, their life is virtually unlimited
- + Excavation of humus is easier than faecal sludge
- + Significant reduction in pathogens
- + Generates nutrient-rich humus with good potential for use as soil conditioner
- + Flies and odours are significantly reduced (compared to non-ventilated pits)
- + Can be built and repaired with locally available materials
- + Low (but variable) capital costs depending on materials; no or low operating costs if self-emptied
- Requires constant source of cover material
- Manual removal of humus is required
- Garbage may ruin end-use opportunities of the product

References & Further Reading

- _ Morgan, P. R. (2007). *Toilets That Make Compost. Low-Cost, Sanitary Toilets That Produce Valuable Compost for Crops in an African Context*. Stockholm Environment Institute, Stockholm, SE.
Available at: www.ecosanres.org
- _ Morgan, P. R. (2009). *Ecological Toilets. Start Simple and Upgrade from Arborloo to VIP*. Stockholm Environment Institute, Stockholm, SE.
Available at: www.ecosanres.org

Application Level: <input checked="" type="checkbox"/> Household <input checked="" type="checkbox"/> Neighbourhood <input type="checkbox"/> City	Management Level: <input checked="" type="checkbox"/> Household <input checked="" type="checkbox"/> Shared <input checked="" type="checkbox"/> Public	Inputs:  Blackwater  Greywater
		Outputs:  Pit Humus

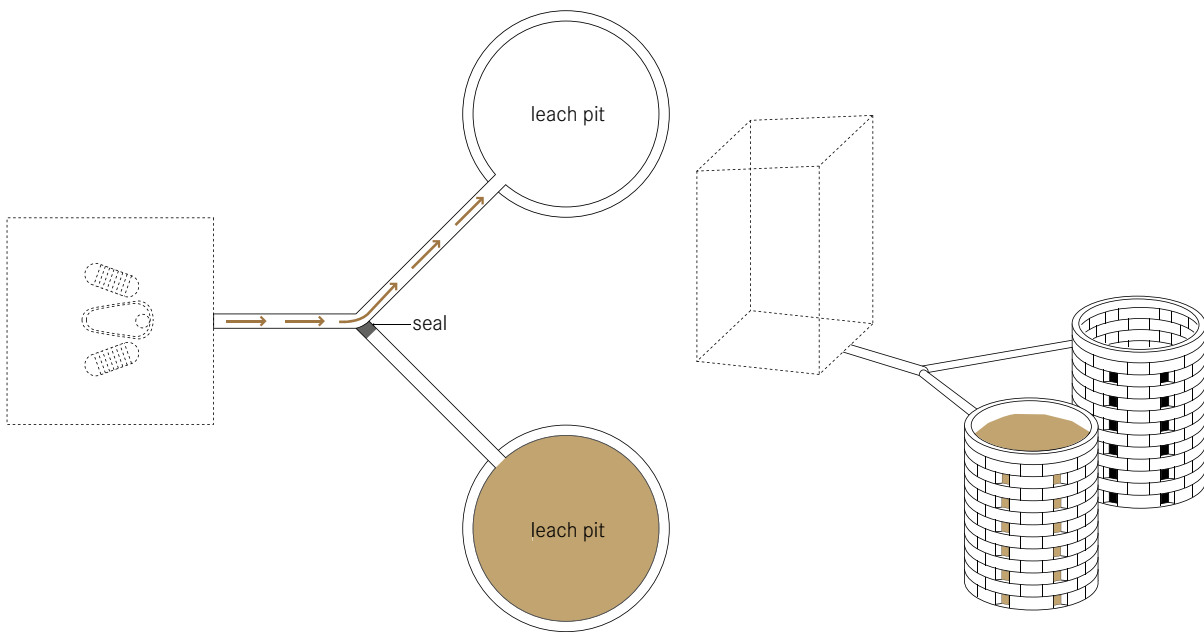

This technology consists of two alternating pits connected to a Pour Flush Toilet (U.4). The blackwater (and in some cases greywater) is collected in the pits and allowed to slowly infiltrate into the surrounding soil. Over time, the solids are sufficiently dewatered and can be manually removed with a shovel.

The twin pits for pour flush technology can be designed in various ways; the toilet can be located directly over the pits or at a distance from them. The superstructure can be permanently constructed over both pits or it can move from side to side depending on which one is in use. No matter how the system is designed, only one pit is used at a time. While one pit is filling, the other full pit is resting.

As liquid leaches from the pit and migrates through the unsaturated soil matrix, pathogenic germs are sorbed onto the soil surface. In this way, pathogens can be removed prior to contact with groundwater. The degree of removal varies with soil type, distance travelled, moisture and other environmental factors.

The difference between this technology and the Double VIP (S.4) or Fossa Alterna (S.5) is that it allows for water and it is not necessary to add soil or organic material

to the pits. As this is a water-based (wet) technology, the full pits require a longer retention time (two years is recommended) to degrade the material before it can be excavated safely.

Design Considerations The pits should be of an adequate size to accommodate a volume of waste generated over one or two years. This allows the contents of the full pit enough time to transform into a partially sanitized, soil-like material that can be manually excavated. It is recommended that the twin pits be constructed 1 m apart from each other to minimize cross-contamination between the maturing pit and the one in use. It is also recommended that the pits be constructed over 1 m from any structural foundation as leachate can negatively impact structural supports. Water within the pit can impact its stability. Therefore, the full depth of the pit walls should be lined to prevent collapse and the top 30 cm should be fully mortared to prevent direct infiltration and to support the superstructure.

There is a risk of groundwater pollution when pits are located in areas with a high or variable water table, and/or fissures or cracks in the bedrock. As soil and groundwater properties are often unknown, it is difficult

to estimate the distance necessary between a pit and a water source. It is normally recommended to have a minimum horizontal distance of 30 m between them to limit exposing the water source to microbial contamination.

To ensure that only one of the two pits is used at any time, the idle pipe of the junction connecting to the out-of-use pit should be closed (e.g. with cement or bricks). Alternatively, the Pour Flush Toilet could also be directly connected to the pit in use by a single straight pipe fixed in place with light mortar and covered with earth. The risk of failure and misuse is minimized by ensuring that the junction and pipes are not easily accessible.

Appropriateness Twin pits for pour flush are a permanent technology appropriate for areas where it is not possible to continuously build new pit latrines. As long as water is available, this technology is appropriate for almost every type of housing density. However, too many wet pits in a small area is not recommended as the soil matrix may not be of sufficient capacity to absorb all the liquid and the ground could become water-logged (oversaturated). In order for the pits to drain properly, the soil must have a good absorptive capacity; clay, tightly packed or rocky soils are not appropriate. This technology is not suitable for areas with a high groundwater table or where there is frequent flooding.

Greywater can be co-managed along with the blackwater in the twin pits, especially if the greywater quantities are relatively small, and no other management system is in place to control it. However, large quantities of flushwater and/or greywater may result in excessive leaching from the pit and possibly groundwater contamination.

The dewatered, solid material is manually emptied from the pits (it is dug, not pumped out), therefore, space is not required for vacuum trucks to access them.

Health Aspects/Acceptance It is a commonly accepted sanitation option; however, some health concerns exist:

- Leachate can contaminate groundwater;
- Stagnant water in pits may promote insect breeding;
- Pits are susceptible to failure and/or overflowing during floods.

Operation & Maintenance









The pits must be regularly emptied (after the recommended two year resting time), and care must be taken to ensure that they do not flood during rainy seasons. Emptying is done manually using long handled shovels and proper personal protection.

Pros & Cons

- + Because double pits are used alternately, their life is virtually unlimited
- + Excavation of humus is easier than faecal sludge
- + Significant reduction in pathogens
- + Potential for use of stored faecal material as soil conditioner
- + Flies and odours are significantly reduced (compared to pits without a water seal)
- + Can be built and repaired with locally available materials
- + Low (but variable) capital costs depending on materials; no or low operating costs if self-emptied
- + Small land area required
- Manual removal of humus is required
- Clogging is frequent when bulky cleansing materials are used
- Higher risk of groundwater contamination due to more leachate than with waterless systems

References & Further Reading

- Franceys, R., Pickford, J. and Reed, R. (1992). *A Guide to the Development of on-Site Sanitation*. WHO, Geneva, CH. Available at: www.susana.org/library
- Mara, D. D. (1985). *The Design of Pour-Flush Latrines*. UNDP Interregional Project INT/81/047, The World Bank and UNDP, Washington, D.C., US. Available at: documents.worldbank.org/curated/en/home
- Mara, D. D. (1996). *Low-Cost Urban Sanitation*. Wiley, Chichester, UK.
- Roy, A. K., Chatterjee, P. K., Gupta, K. N., Khare, S. T., Rau, B. B. and Singh, R. S. (1984). *Manual on the Design, Construction and Maintenance of Low-Cost Pour-Flush Waterseal Latrines in India*. UNDP Interregional Project INT/81/047, The World Bank and UNDP, Washington, D.C., US. Available at: documents.worldbank.org/curated/en/home

Application Level:	Management Level:	Inputs:  Faeces (+  Dry Cleansing Materials)
 Household	 Household	Outputs:  Dried Faeces
 Neighbourhood	 Shared	
 City	 Public	

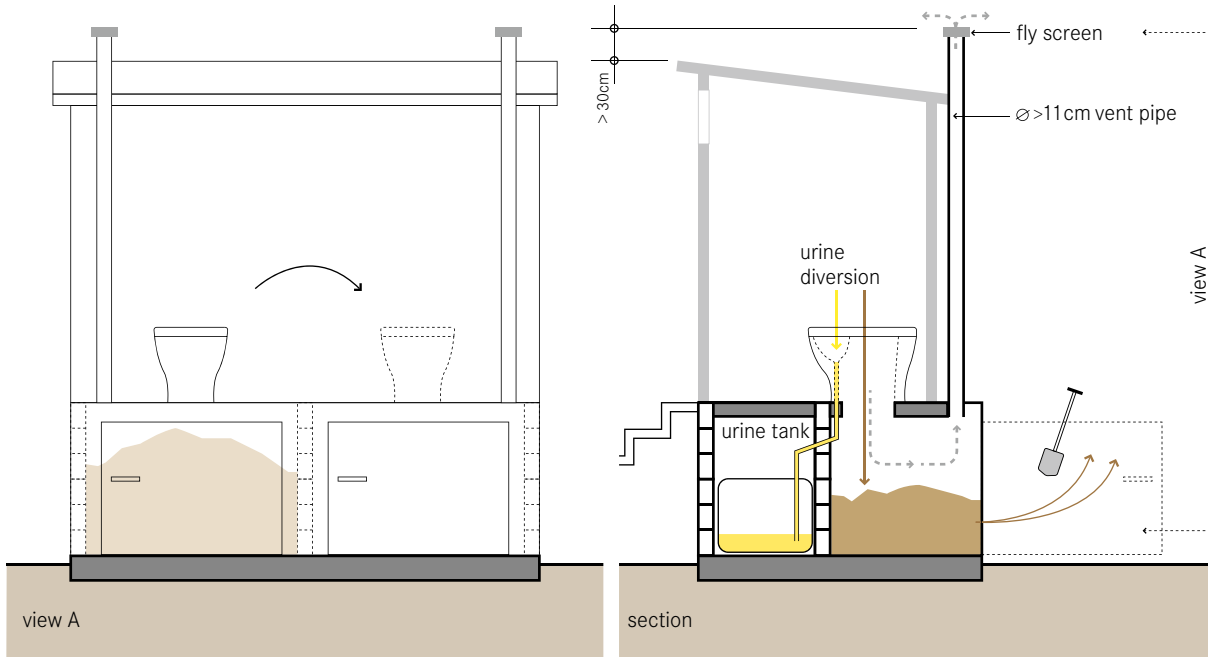

Dehydration vaults are used to collect, store and dry (dehydrate) faeces. Faeces will only dehydrate when the vaults are well ventilated, watertight to prevent external moisture from entering, and when urine and anal cleansing water are diverted away from the vaults.

When faeces are not mixed with urine and other liquids, they dry quickly. In the absence of moisture, organisms cannot grow, pathogens are destroyed and smells minimized.

The use of two alternating vaults allows the faeces to dehydrate in one vault while the other vault fills. When one vault is full, the Urine-Diverting Dry Toilet (UDDT, U.2) is moved to the second vault. While the second vault fills up, the faeces in the first vault dry and decrease in volume. When the second vault is full, the first one is emptied and put back into service.

To prevent flies, minimize odours and encourage drying, a small amount of ash, lime, dry soil or sawdust should be used to cover faeces after each use.

Design Considerations Dehydration vaults can be constructed indoors or with a separate superstruc-

ture. A vent pipe is required to remove humidity from the vaults and control flies and odours. The chambers should be airtight for proper functioning of the ventilation. They should be made of sealed brickwork or concrete to ensure that surface runoff cannot enter.

The WHO recommends a minimum storage time of 6 months if ash or lime are used as cover material (alkaline treatment), otherwise the storage should be for at least 1 year for warm climates (>20 °C average) and for 1.5 to 2 years for colder climates.

In case of alkaline treatment, each vault is sized to accommodate at least 6 months of faeces accumulation. This results in a 6 month storage and dehydration time in the out-of-service vault. The vault dimensions should account for cover material, airflow, the non-even distribution of faeces, and possibly visitors and dry cleansing materials. It can be assumed that one person will require around 50 L of storage volume every 6 months. A minimum chamber height of 60 to 80 cm is recommended for easy emptying and access to the urine pipes.

Appropriateness Dehydration vaults can be installed in almost every setting, from rural to dense urban areas, because of the small land area required, minimal odours

and ease of use. If used in an urban context, this technology relies on a transport service for the dried faeces (and urine) since urban users normally do not have an interest and/or opportunity to use it locally. Dehydration vaults are especially appropriate for water-scarce and rocky areas or where the groundwater table is high. They are also suitable in areas that are frequently flooded because they are built to be watertight.

Health Aspects/Acceptance Dehydration vaults can be a clean, comfortable, and easy-to-use technology. It is crucial, however, that the users are well trained to understand how the technology works and appreciate its benefits.

When the vaults are kept dry, there should not be any problems with flies or odours. After the recommended storage time, the faeces should be very dry and relatively safe to handle, provided that they did not get wet. However, a low health risk remains. Single dehydration vaults or bins do not allow faeces to sufficiently dehydrate. When the full container needs emptying, the faeces on top are still fresh. Hence, the risk associated with the handling of faecal matter is inherently higher in single vaults compared to double vault designs. The use of alternating chambers is, therefore, recommended. However, research and field tests of sealed faeces containers (or cartridges) for safe transportation and easy cleaning, along with the corresponding logistics, are on-going.

Operation & Maintenance Just like the faeces which are dried, but not degraded in the vaults, dry cleansing materials will not decompose in the chambers. Whenever the material is intended to be applied onto fields without further treatment, it is recommended to separately collect and dispose of the dry cleansing materials. Occasionally, the faeces that have accumulated beneath the toilet should be pushed to the sides of the chamber.













Care should be taken to ensure that no water or urine gets into the dehydration vault. If this happens, extra ash, lime, soil or sawdust can be added to help absorb the liquid. To empty the vaults, a shovel, gloves and possibly a facemask (cloth) should be used to avoid contact with the dried faeces.

Pros & Cons

- + Because double vaults are used alternately, their life is virtually unlimited
- + Significant reduction in pathogens
- + Potential for use of dried faeces as soil conditioner
- + No real problems with flies or odours if used and maintained correctly (i.e., kept dry)
- + Can be built and repaired with locally available materials
- + Suitable for rocky and/or flood prone areas or where the groundwater table is high
- + Low (but variable) capital costs depending on materials; no or low operating costs if self-emptied
- Requires training and acceptance to be used correctly
- Requires constant source of cover material
- Manual removal of dried faeces is required

References & Further Reading

- Deegener, S., Samwel, M. and Gabizon, S. (2006). *Urine Diverting Toilets. Principles, Operation and Construction*. Women in Europe for a Common Future, Utrecht, NL and Munich, DE.
Available at: www.wecf.de
(Photos and explanation of how to build a double vault and superstructure)
- Rieck, C., von Münch, E. and Hoffmann, H. (2012). *Technology Review of Urine-Diverting Dry Toilets (UDDTs). Overview of Design, Operation, Management and Costs*. Deutsche Gesellschaft für Internationale Zusammenarbeit (GIZ) GmbH, Eschborn, DE.
Available at: www.susana.org/library
- Winblad, U. and Simpson-Hébert, M. (Eds.) (2004). *Ecological Sanitation. Revised and Enlarged Edition*. Stockholm Environment Institute, Stockholm, SE.
Available at: www.ecosanres.org
(A general description of various designs and adaptations, especially Chapter 3)
- WHO (2006). *Guidelines for the Safe Use of Wastewater, Excreta and Greywater. Volume 4: Excreta and Greywater Use in Agriculture*. World Health Organization, Geneva, CH.
Available at: www.who.int

Application Level:	Management Level:	Inputs:  Excreta  Faeces  Organics (+  Dry Cleansing Materials)
		Outputs:  Compost  Effluent
 Household	 Household	
 Neighbourhood	 Shared	
 City	 Public	

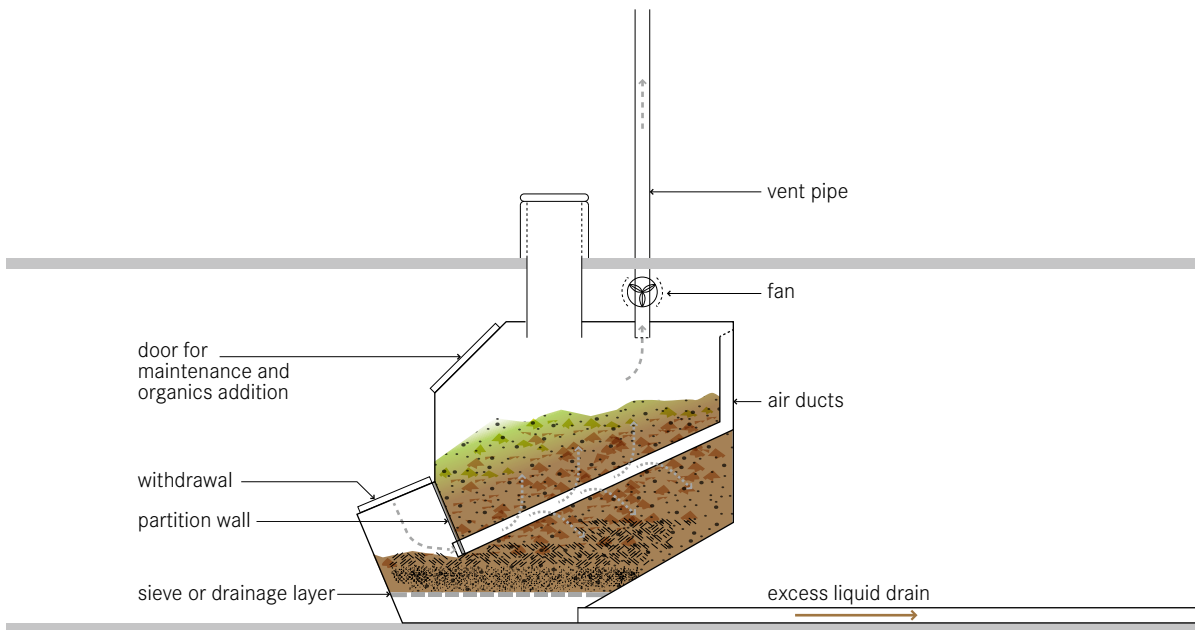

Composting refers to the process by which biodegradable components are biologically decomposed by microorganisms (mainly bacteria and fungi) under aerobic conditions. A composting chamber is designed to convert excreta and organics into compost. Compost is a stable, inoffensive product that can be safely handled and used as a soil conditioner.

This technology usually requires four main parts: (1) a reactor (storage chamber); (2) a ventilation unit to provide oxygen and allow gases (CO₂, water vapour) to escape; (3) a leachate collection system; and (4) an access door to remove the mature product.

Excreta, organics, food waste and bulking material (such as wood chips, sawdust, ash or paper) are mixed in the chamber. There are four factors that ensure the good functioning of the system: (a) sufficient oxygen, provided by active or passive aeration; (b) proper moisture (ideally 45 to 70% moisture content); (c) internal (heap) temperature of 40 to 50 °C (achieved by proper chamber dimensioning); and (d) a 25:1 C:N ratio (theoretically) which can be adjusted by adding bulking material as a carbon source.

In practice, these optimal conditions are difficult to

maintain. As a result, the output product is often not sufficiently stabilized and sanitized, and requires further treatment.

Design Considerations A composting chamber can be designed in various configurations and constructed above or below ground, indoors or with a separate superstructure.

A design value of 300 L/person/year can be used to calculate the required chamber volume.

Ventilation channels (air ducts) under the heap can be beneficial for aeration. More complex designs can include a small ventilation fan, a mechanical mixer, or multiple compartments to allow for increased storage and degradation time. A sloped bottom and a chamber for compost withdrawal facilitate access to the final product. A drainage system is important to ensure the removal of leachate. Excessive ammonia from urine inhibits the microbial processes in the chamber. The use of a Urine-Diverting Dry Toilet (UDDT, U.2) or Urinal (U.3) can, therefore, improve the quality of the compost.

Appropriateness Since this technology is compact and waterless, it is especially suited in areas where land

and water are limited, or when there is a need for compost. It can also be installed in rocky areas, or where the groundwater table is high. In cold climates, a composting chamber should be indoors to ensure that low temperatures do not impede the microbial processes. This technology cannot be used for the collection of anal cleansing water or greywater; if the reactor becomes too wet, anaerobic conditions will cause odour problems and improper degradation.

Health Aspects/Acceptance If the composting chamber is well designed, the users will not have to handle the material during the first year.

A well-functioning composting chamber should not produce odours. If there is ample bulking material and good ventilation, there should be no problems with flies or other insects. When removing the final product, it is advisable to wear protective clothing to prevent contact with (partially) composted material.

Operation & Maintenance Although simple in theory, composting chambers are not that easy to operate. The moisture must be controlled, the C:N ratio must be well balanced and the volume of the unit must be such that the temperature of the compost pile remains high to achieve pathogen reduction. After each defecation, a small amount of bulking material is added to absorb excess liquid, improve the aeration of the pile and balance the carbon availability. Turning the material from time to time will boost the oxygen supply.

A squeeze test can be made to check the moisture level within the chamber. When squeezing a handful of compost, it should not crumble or feel dry, nor should it feel like a wet sponge. Rather, the compost should leave only a few drops of water in one's hand. If the material in the chamber becomes too compact and humid, additional bulking material should be added. If a UDDT is used, some water should be added to obtain the required humidity.

Depending on the design, the composting chamber should be emptied every 2 to 10 years. Only the mature compost should be removed. The material may require further treatment to become hygienically safe (e.g., Co-Composting, see T.16).

With time, salt or other solids may build up in the tank

or drainage system. These can be dissolved with hot water and/or scraped out.

Pros & Cons

- + Significant reduction in pathogens
- + Compost can be used as a soil conditioner
- + No real problems with flies or odours if used and maintained correctly
- + Organic solid waste can be managed concurrently
- + Long service life
- + Low operating costs if self-emptied
- Requires well-trained user or service personnel for monitoring and maintenance
- Compost might require further treatment before use
- Leachate requires treatment and/or appropriate discharge
- Requires expert design and construction
- May require some specialized parts and electricity
- Requires constant source of organics
- Manual removal of compost is required

References & Further Reading

- Berger, W. (2011). *Technology Review of Composting Toilets. Basic Overview of Composting Toilets (with or without Urine Diversion)*. Gesellschaft für Internationale Zusammenarbeit (GIZ) GmbH, Eschborn, DE. Available at: www.susana.org/library
- Del Porto, D. and Steinfeld, C. (1999). *The Composting Toilet System Book. A Practical Guide to Choosing, Planning and Maintaining Composting Toilet Systems, an Alternative to Sewer and Septic Systems*. The Center for Ecological Pollution Prevention (CEPP), Concord, MA, US.
- Hill, G. B., Baldwin, S. A. and Vinnerås, B. (2013). *Composting Toilets a Misnomer: Excessive Ammonia from Urine Inhibits Microbial Activity yet Is Insufficient in Sanitizing the End-Product*. *Journal of Environmental Management* 119 (2013): 29-35.
- Jenkins, J. (2005). *The Humanure Handbook. A Guide to Composting Human Manure*. 3rd Ed. Jenkins Publishing, Grove City, PA, US.
- U.S. EPA (1999). *Water Efficiency Technology Fact Sheet. Composting Toilets*. EPA 832-F-99-066. U.S. Environmental Protection Agency, Washington, D.C., US. Available at: www.epa.gov

Application Level:

- Household
- Neighbourhood
- City

Management Level:

- Household
- Shared
- Public

Inputs: Blackwater Brownwater
 Greywater

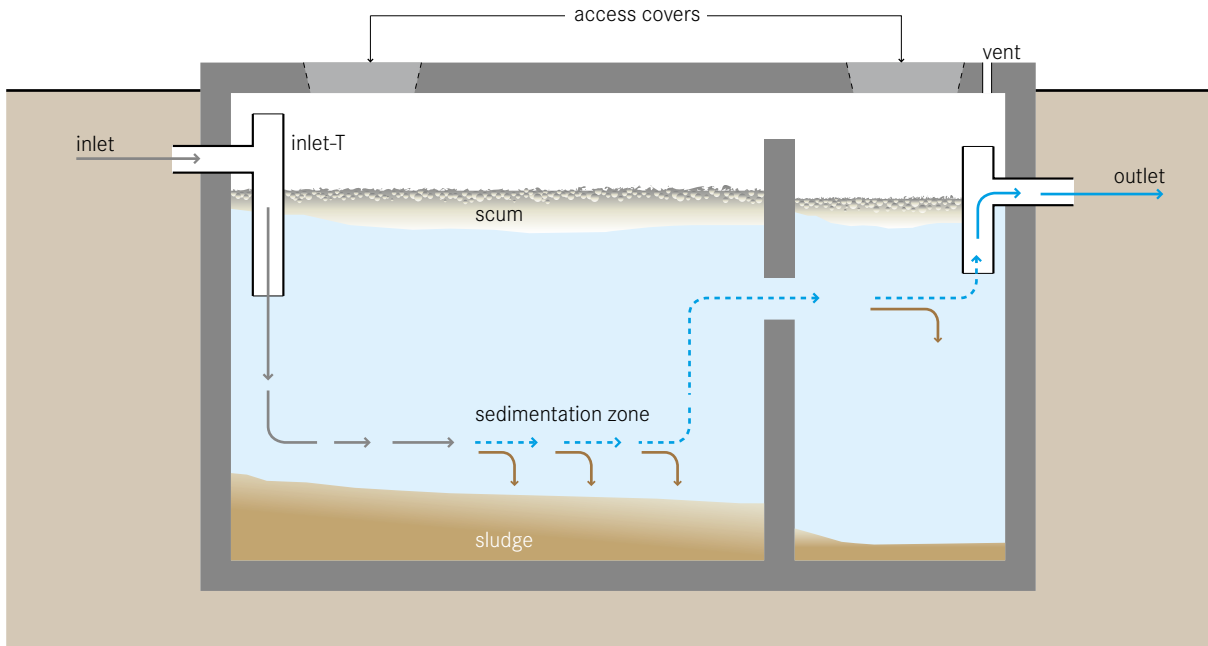
Outputs: Effluent Sludge

A septic tank is a watertight chamber made of concrete, fibreglass, PVC or plastic, through which blackwater and greywater flows for primary treatment. Settling and anaerobic processes reduce solids and organics, but the treatment is only moderate.

Liquid flows through the tank and heavy particles sink to the bottom, while scum (mostly oil and grease) floats to the top. Over time, the solids that settle to the bottom are degraded anaerobically. However, the rate of accumulation is faster than the rate of decomposition, and the accumulated sludge and scum must be periodically removed. The effluent of the septic tank must be dispersed by using a Soak Pit (D.7) or Leach Field (D.8), or transported to another treatment technology via a Solids-Free Sewer (C.5).

Generally, the removal of 50% of solids, 30 to 40% of BOD and a 1-log removal of *E. coli* can be expected in a well-designed and maintained septic tank, although efficiencies vary greatly depending on operation and maintenance and climatic conditions.

Design Considerations A septic tank should have at least two chambers. The first chamber should be

at least 50% of the total length, and when there are only two chambers, it should be two thirds of the total length. Most of the solids settle out in the first chamber. The baffle, or the separation between the chambers, is to prevent scum and solids from escaping with the effluent. A T-shaped outlet pipe further reduces the scum and solids that are discharged.

Accessibility to all chambers (through access ports) is necessary for maintenance. Septic tanks should be vented for controlled release of odorous and potentially harmful gases.

The design of a septic tank depends on the number of users, the amount of water used per capita, the average annual temperature, the desludging frequency and the characteristics of the wastewater. The retention time should be 48 hours to achieve moderate treatment.

A variation of the septic tank is called an Aquaprivy. This is a simple storage and settling tank that is located directly below the toilet so that the excreta fall into it. The Aquaprivy has a low treatment efficiency.

Appropriateness This technology is most commonly applied at the household level. Larger, multi-chamber

septic tanks can be designed for groups of houses and/or public buildings (e.g., schools).

A septic tank is appropriate where there is a way of dispersing or transporting the effluent. If septic tanks are used in densely populated areas, onsite infiltration should not be used, otherwise, the ground will become oversaturated and contaminated, and wastewater may rise up to the surface, posing a serious health risk. Instead, the septic tanks should be connected to some type of Conveyance technology, through which the effluent is transported to a subsequent Treatment or Disposal site. Even though septic tanks are watertight, it is not recommended to construct them in areas with high groundwater tables or where there is frequent flooding.

Because the septic tank must be regularly desludged, a vacuum truck should be able to access the location. Often, septic tanks are installed in the home, under the kitchen or bathroom, which makes emptying difficult.

Septic tanks can be installed in every type of climate, although the efficiency will be lower in colder climates. They are not efficient at removing nutrients and pathogens.

Health Aspects/Acceptance Under normal operating conditions, users do not come in contact with the influent or effluent. Effluent, scum and sludge must be handled with care as they contain high levels of pathogenic organisms.

Users should be careful when opening the tank because noxious and flammable gases may be released.

Operation & Maintenance Because of the delicate ecology, care should be taken not to discharge harsh chemicals into the septic tank. Scum and sludge levels need to be monitored to ensure that the tank is functioning well. Generally, septic tanks should be emptied every 2 to 5 years. This is best done by using a Motorized Emptying and Transport technology (C.3), but Human-Powered Emptying (C.2) can also be an option.

Septic tanks should be checked from time to time to ensure that they are watertight.

Pros & Cons

- + Simple and robust technology
- + No electrical energy is required
- + Low operating costs
- + Long service life
- + Small land area required (can be built underground)
- Low reduction in pathogens, solids and organics
- Regular desludging must be ensured
- Effluent and sludge require further treatment and/or appropriate discharge

References & Further Reading

- Crites, R. and Tchobanoglous, G. (1998). *Small and Decentralized Wastewater Management Systems*. WCB/McGraw-Hill, New York, US.
- Mara, D. D. (1996). *Low-Cost Urban Sanitation*. Wiley, Chichester, UK.
(Sizing, volume and emptying calculations and example design solutions – Chapter 6)
- Oxfam (2008). *Septic Tank Guidelines*. Technical Brief. Oxfam GB, Oxford, UK.
Available at: policy-practice.oxfam.org.uk
- Polprasert, C. and Rajput, V. S. (1982). *Environmental Sanitation Reviews. Septic Tank and Septic Systems*. Environmental Sanitation Information Center, AIT, Bangkok, TH. pp. 68-74.
(Comprehensive design manual)
- Ulrich, A. (Ed.), Reuter, S. (Ed.), Gutterer, B. (Ed.), Sasse, L., Panzerbieter, T. and Reckerzügel, T. (2009). *Decentralised Wastewater Treatment Systems (DEWATS) and Sanitation in Developing Countries. A Practical Guide*. WEDC, Loughborough University, Leicestershire, UK.

Application Level:

- ★ Household
- ★★ Neighbourhood
- City

Management Level:

- ★ Household
- ★★ Shared
- ★★ Public

Inputs: Blackwater Brownwater
 Greywater

Outputs: Effluent Sludge

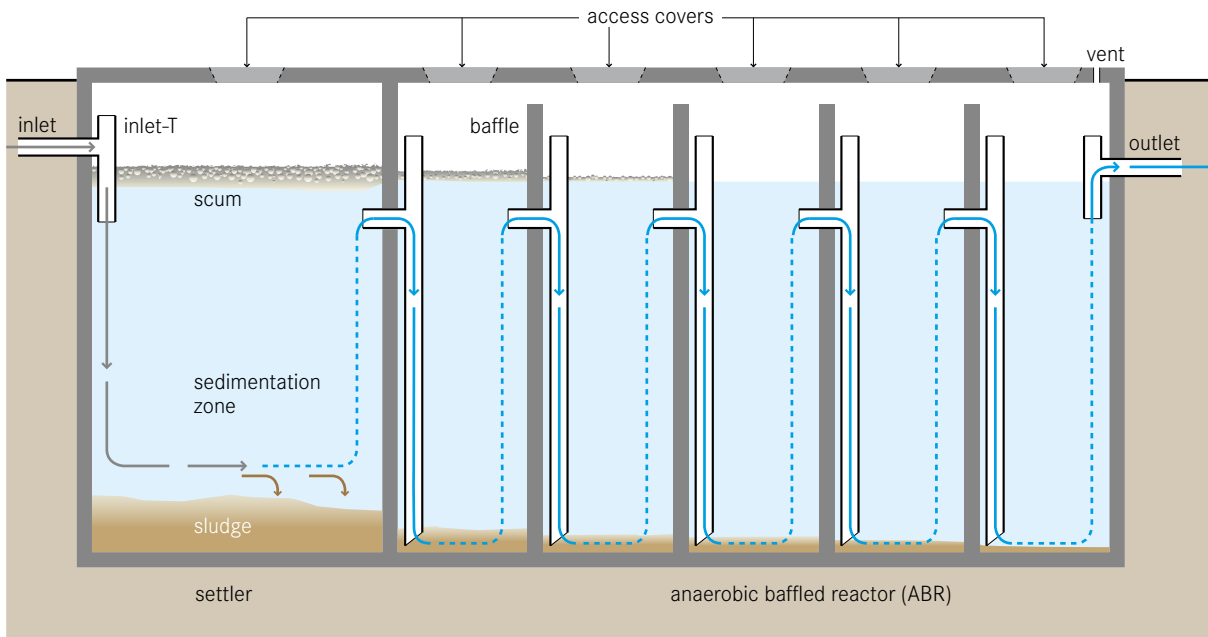

An anaerobic baffled reactor (ABR) is an improved Septic Tank (S.9) with a series of baffles under which the wastewater is forced to flow. The increased contact time with the active biomass (sludge) results in improved treatment.

The upflow chambers provide enhanced removal and digestion of organic matter. BOD may be reduced by up to 90%, which is far superior to its removal in a conventional Septic Tank.

Design Considerations The majority of settleable solids are removed in a sedimentation chamber in front of the actual ABR. Small-scale, stand-alone units typically have an integrated settling compartment, but primary sedimentation can also take place in a separate Settler (T.1) or another preceding technology (e.g., existing Septic Tanks). Designs without a settling compartment (as shown in T.3) are of particular interest for (Semi-) Centralized Treatment plants that combine the ABR with another technology for primary settling, or where prefabricated, modular units are used.

Typical inflows range from 2 to 200 m³ per day. Critical design parameters include a hydraulic retention

time (HRT) between 48 to 72 hours, upflow velocity of the wastewater below 0.6 m/h and the number of upflow chambers (3 to 6). The connection between the chambers can be designed either with vertical pipes or baffles. Accessibility to all chambers (through access ports) is necessary for maintenance. Usually, the biogas produced in an ABR through anaerobic digestion is not collected because of its insufficient amount. The tank should be vented to allow for controlled release of odorous and potentially harmful gases.

Appropriateness This technology is easily adaptable and can be applied at the household level, in small neighbourhoods or even in bigger catchment areas. It is most appropriate where a relatively constant amount of blackwater and greywater is generated. A (semi-) centralized ABR is appropriate when there is a pre-existing Conveyance technology, such as a Simplified Sewer (C.4).

This technology is suitable for areas where land may be limited since the tank is most commonly installed underground and requires a small area. However, a vacuum truck should be able to access the location because the sludge must be regularly removed (particularly from the settler).

ABRs can be installed in every type of climate, although the efficiency is lower in colder climates. They are not efficient at removing nutrients and pathogens. The effluent usually requires further treatment.

Health Aspects/Acceptance Under normal operating conditions, users do not come in contact with the influent or effluent. Effluent, scum and sludge must be handled with care as they contain high levels of pathogenic organisms. The effluent contains odorous compounds that may have to be removed in a further polishing step. Care should be taken to design and locate the facility such that odours do not bother community members.

Operation & Maintenance An ABR requires a start-up period of several months to reach full treatment capacity since the slow growing anaerobic biomass first needs to be established in the reactor. To reduce start-up time, the ABR can be inoculated with anaerobic bacteria, e.g., by adding fresh cow dung or Septic Tank sludge. The added stock of active bacteria can then multiply and adapt to the incoming wastewater. Because of the delicate ecology, care should be taken not to discharge harsh chemicals into the ABR.

Scum and sludge levels need to be monitored to ensure that the tank is functioning well. Process operation in general is not required, and maintenance is limited to the removal of accumulated sludge and scum every 1 to 3 years. This is best done using a Motorized Emptying and Transport technology (C.3). The desludging frequency depends on the chosen pre-treatment steps, as well as on the design of the ABR.

ABR tanks should be checked from time to time to ensure that they are watertight.

Pros & Cons

- + Resistant to organic and hydraulic shock loads
- + No electrical energy is required
- + Low operating costs
- + Long service life
- + High reduction of BOD
- + Low sludge production; the sludge is stabilized
- + Moderate area requirement (can be built underground)

- Requires expert design and construction
- Low reduction of pathogens and nutrients
- Effluent and sludge require further treatment and/or appropriate discharge

References & Further Reading

- Bachmann, A., Beard, V. L. and McCarty, P. L. (1985). *Performance Characteristics of the Anaerobic Baffled Reactor*. Water Research 19 (1): 99-106.
- Barber, W. P. and Stuckey, D. C. (1999). *The Use of the Anaerobic Baffled Reactor (ABR) for Wastewater Treatment: A Review*. Water Research 33 (7): 1559-1578.
- Foxon, K. M., Buckley, C. A., Brouckaert, C. J., Dama, P., Mtembu, Z., Rodda, N., Smith, M., Pillay, S., Arjun, N., Lalbahadur, T. and Bux, F. (2006). *Evaluation of the Anaerobic Baffled Reactor for Sanitation in Dense Peri-urban Settlements*. WRC Report No 1248/01/06, Water Research Commission, Pretoria, ZA. Available at: www.wrc.org.za
- Foxon, K. M., Pillay, S., Lalbahadur, T., Rodda, N., Holder, F. and Buckley, C. A. (2004). *The Anaerobic Baffled Reactor (ABR): An Appropriate Technology for on-Site Sanitation*. Water SA 30 (5) (Special Edition). Available at: www.wrc.org.za
- Stuckey, D. C. (2010). *Anaerobic Baffled Reactor (ABR) for Wastewater Treatment*. In: Environmental Anaerobic Technology. Applications and New Developments, H. H. P. Fang (Ed.), Imperial College Press, London, UK.
- Ulrich, A. (Ed.), Reuter, S. (Ed.), Gutterer, B. (Ed.), Sasse, L., Panzerbieter, T. and Reckerzügel, T. (2009). *Decentralised Wastewater Treatment Systems (DEWATS) and Sanitation in Developing Countries. A Practical Guide*. WEDC, Loughborough University, Leicestershire, UK.

Application Level:

- ★ Household
- ★★ Neighbourhood
- City

Management Level:

- ★ Household
- ★★ Shared
- ★★ Public

Inputs: Blackwater Brownwater
 Greywater

Outputs: Effluent Sludge

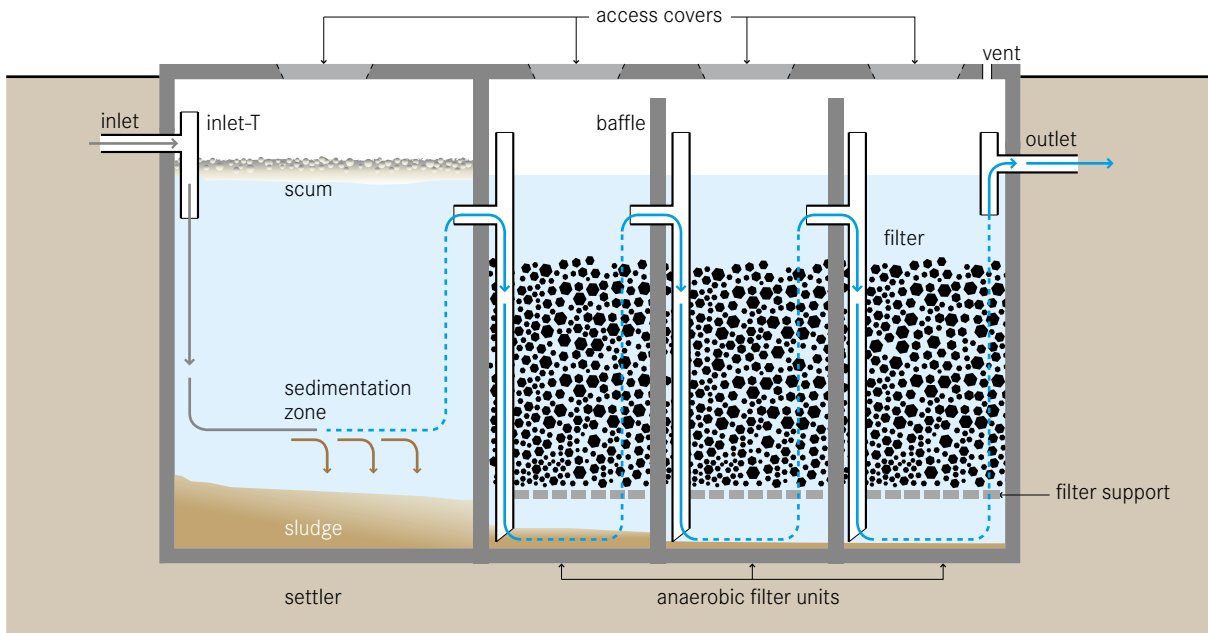

An anaerobic filter is a fixed-bed biological reactor with one or more filtration chambers in series. As wastewater flows through the filter, particles are trapped and organic matter is degraded by the active biomass that is attached to the surface of the filter material.

With this technology, suspended solids and BOD removal can be as high as 90%, but is typically between 50% and 80%. Nitrogen removal is limited and normally does not exceed 15% in terms of total nitrogen (TN).

Design Considerations Pre- and primary treatment is essential to remove solids and garbage that may clog the filter. The majority of settleable solids are removed in a sedimentation chamber in front of the anaerobic filter. Small-scale, stand-alone units typically have an integrated settling compartment, but primary sedimentation can also take place in a separate Settler (T.1) or another preceding technology (e.g., existing Septic Tanks). Designs without a settling compartment (as shown in T.4) are of particular interest for (Semi-) Centralized Treatment plants that combine the anaerobic filter with other technologies, such as the Anaerobic Baffled Reactor (ABR, T.3).

Anaerobic filters are usually operated in upflow mode because there is less risk that the fixed biomass will be washed out. The water level should cover the filter media by at least 0.3 m to guarantee an even flow regime. The hydraulic retention time (HRT) is the most important design parameter influencing filter performance. An HRT of 12 to 36 hours is recommended.

The ideal filter should have a large surface area for bacteria to grow, with pores large enough to prevent clogging. The surface area ensures increased contact between the organic matter and the attached biomass that effectively degrades it. Ideally, the material should provide between 90 to 300 m² of surface area per m³ of occupied reactor volume. Typical filter material sizes range from 12 to 55 mm in diameter. Materials commonly used include gravel, crushed rocks or bricks, cinder, pumice, or specially formed plastic pieces, depending on local availability. The connection between the chambers can be designed either with vertical pipes or baffles. Accessibility to all chambers (through access ports) is necessary for maintenance. The tank should be vented to allow for controlled release of odorous and potentially harmful gases.

Appropriateness This technology is easily adaptable and can be applied at the household level, in small neighbourhoods or even in bigger catchment areas. It is most appropriate where a relatively constant amount of blackwater and greywater is generated. The anaerobic filter can be used for secondary treatment, to reduce the organic loading rate for a subsequent aerobic treatment step, or for polishing.

This technology is suitable for areas where land may be limited since the tank is most commonly installed underground and requires a small area. Accessibility by vacuum truck is important for desludging.

Anaerobic filters can be installed in every type of climate, although the efficiency is lower in colder climates. They are not efficient at removing nutrients and pathogens. Depending on the filter material, however, complete removal of worm eggs may be achieved. The effluent usually requires further treatment.

Health Aspects/Acceptance Under normal operating conditions, users do not come in contact with the influent or effluent. Effluent, scum and sludge must be handled with care as they contain high levels of pathogenic organisms. The effluent contains odorous compounds that may have to be removed in a further polishing step. Care should be taken to design and locate the facility such that odours do not bother community members.

Operation & Maintenance An anaerobic filter requires a start-up period of 6 to 9 months to reach full treatment capacity since the slow growing anaerobic biomass first needs to be established on the filter media. To reduce start-up time, the filter can be inoculated with anaerobic bacteria, e.g., by spraying Septic Tank sludge onto the filter material. The flow should be gradually increased over time. Because of the delicate ecology, care should be taken not to discharge harsh chemicals into the anaerobic filter.

Scum and sludge levels need to be monitored to ensure that the tank is functioning well. Over time, solids will clog the pores of the filter. As well, the growing bacterial mass will become too thick, break off and eventually clog pores. When the efficiency decreases, the filter

must be cleaned. This is done by running the system in reverse mode (backwashing) or by removing and cleaning the filter material.













Anaerobic filter tanks should be checked from time to time to ensure that they are watertight.

Pros & Cons

- + No electrical energy is required
- + Low operating costs
- + Long service life
- + High reduction of BOD and solids
- + Low sludge production; the sludge is stabilized
- + Moderate area requirement (can be built underground)
- Requires expert design and construction
- Low reduction of pathogens and nutrients
- Effluent and sludge require further treatment and/or appropriate discharge
- Risk of clogging, depending on pre- and primary treatment
- Removing and cleaning the clogged filter media is cumbersome

References & Further Reading

- Morel, A. and Diener, S. (2006). *Greywater Management in Low and Middle-Income Countries. Review of Different Treatment Systems for Households or Neighbourhoods*. Eawag (Department Sandec), Dübendorf, CH. Available at: www.sandec.ch (Short summary including case studies – p. 28)
- von Sperling, M. and de Lemos Chernicharo, C. A. (2005). *Biological Wastewater Treatment in Warm Climate Regions, Volume One*. IWA Publishing, London, UK. pp. 728-804. Available at: www.iwawaterwiki.org (Detailed design instructions)
- Ulrich, A. (Ed.), Reuter, S. (Ed.), Gutterer, B. (Ed.), Sasse, L., Panzerbieter, T. and Reckerzügel, T. (2009). *Decentralised Wastewater Treatment Systems (DEWATS) and Sanitation in Developing Countries. A Practical Guide*. WEDC, Loughborough University, Leicestershire, UK. (Design summary including Excel spreadsheets for design calculations)

Application Level:	Management Level:	Inputs:  Sludge  Blackwater
		 Brownwater  Organics
 Household	 Household	Outputs:  Sludge  Biogas
 Neighbourhood	 Shared	
 City	 Public	

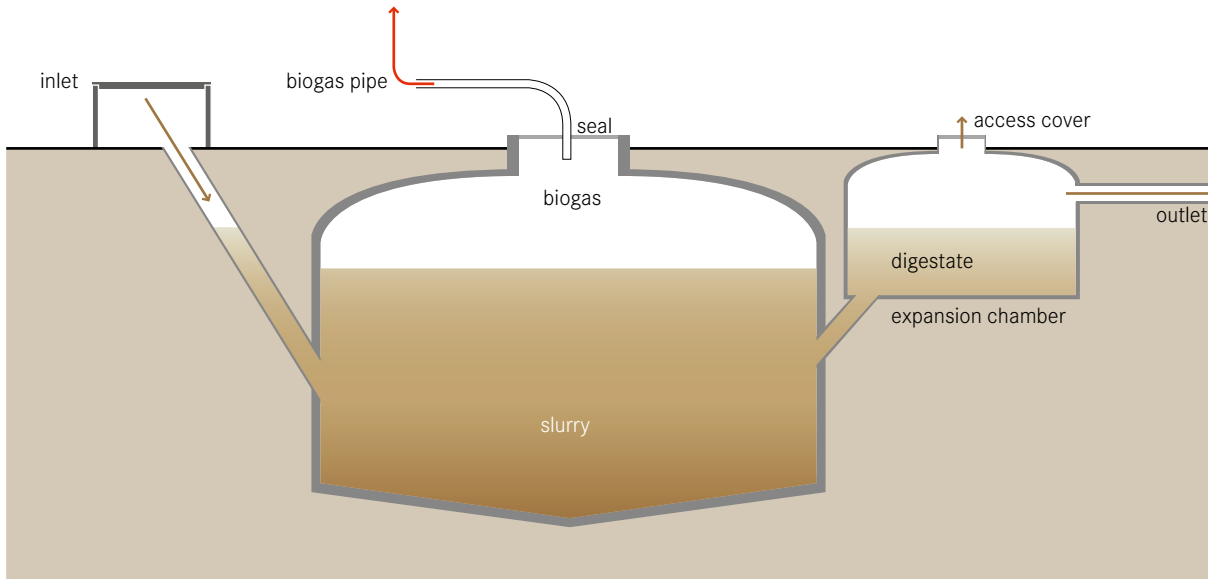

A biogas reactor or anaerobic digester is an anaerobic treatment technology that produces (a) a digested slurry (digestate) that can be used as a fertilizer and (b) biogas that can be used for energy. Biogas is a mix of methane, carbon dioxide and other trace gases which can be converted to heat, electricity or light.

A biogas reactor is an airtight chamber that facilitates the anaerobic degradation of blackwater, sludge, and/or biodegradable waste. It also facilitates the collection of the biogas produced in the fermentation processes in the reactor. The gas forms in the slurry and collects at the top of the chamber, mixing the slurry as it rises. The digestate is rich in organics and nutrients, almost odourless and pathogens are partly inactivated.

Design Considerations Biogas reactors can be brick-constructed domes or prefabricated tanks, installed above or below ground, depending on space, soil characteristics, available resources and the volume of waste generated. They can be built as fixed dome or floating dome digesters. In the fixed dome, the volume of the reactor is constant. As gas is generated it

exerts a pressure and displaces the slurry upward into an expansion chamber. When the gas is removed, the slurry flows back into the reactor. The pressure can be used to transport the biogas through pipes. In a floating dome reactor, the dome rises and falls with the production and withdrawal of gas. Alternatively, it can expand (like a balloon). To minimize distribution losses, the reactors should be installed close to where the gas can be used.

The hydraulic retention time (HRT) in the reactor should be at least 15 days in hot climates and 25 days in temperate climates. For highly pathogenic inputs, a HRT of 60 days should be considered. Normally, biogas reactors are operated in the mesophilic temperature range of 30 to 38 °C. A thermophilic temperature of 50 to 57 °C would ensure the pathogens destruction, but can only be achieved by heating the reactor (although in practice, this is only found in industrialized countries). Often, biogas reactors are directly connected to private or public toilets with an additional access point for organic materials. At the household level, reactors can be made out of plastic containers or bricks. Sizes can vary from 1,000 L for a single family up to 100,000 L for institutional or public toilet applications. Because

the digestate production is continuous, there must be provisions made for its storage, use and/or transport away from the site.

Appropriateness This technology can be applied at the household level, in small neighbourhoods or for the stabilization of sludge at large wastewater treatment plants. It is best used where regular feeding is possible. Often, a biogas reactor is used as an alternative to a Septic Tank (S.9), since it offers a similar level of treatment, but with the added benefit of biogas. However, significant gas production cannot be achieved if blackwater is the only input. The highest levels of biogas production are obtained with concentrated substrates, which are rich in organic material, such as animal manure and organic market or household waste. It can be efficient to co-digest blackwater from a single household with manure if the latter is the main source of feedstock. Greywater should not be added as it substantially reduces the HRT. Wood material and straw are difficult to degrade and should be avoided in the substrate. Biogas reactors are less appropriate for colder climates as the rate of organic matter conversion into biogas is very low below 15 °C. Consequently, the HRT needs to be longer and the design volume substantially increased.

Health Aspects/Acceptance The digestate is partially sanitized but still carries a risk of infection. Depending on its end-use, further treatment might be required. There are also dangers associated with the flammable gases that, if mismanaged, could be harmful to human health.

Operation & Maintenance If the reactor is properly designed and built, repairs should be minimal. To start the reactor, it should be inoculated with anaerobic bacteria, e.g., by adding cow dung or Septic Tank sludge. Organic waste used as substrate should be shredded and mixed with water or digestate prior to feeding. Gas equipment should be carefully and regularly cleaned so that corrosion and leaks are prevented. Grit and sand that have settled to the bottom should be removed. Depending on the design and the inputs, the reactor should be emptied once every 5 to 10 years.

Pros & Cons

- + Generation of renewable energy
- + Small land area required (most of the structure can be built underground)
- + No electrical energy required
- + Conservation of nutrients
- + Long service life
- + Low operating costs
- Requires expert design and skilled construction
- Incomplete pathogen removal, the digestate might require further treatment
- Limited gas production below 15 °C

References & Further Reading

- CMS (1996). *Biogas Technology: A Training Manual for Extension*. FAO/TCP/NEP/4451-T. Consolidated Management Services, Kathmandu, NP. Available at: www.fao.org
- GTZ (1998). *Biogas Digest. Volume I-IV*. Information and Advisory Service on Appropriate Technology (ISAT). Deutsche Gesellschaft für Technische Zusammenarbeit (GTZ) GmbH, Eschborn, DE. Available at: www.susana.org/library
- Mang, H.-P. and Li, Z. (2010). *Technology Review of Biogas Sanitation. Draft – Biogas Sanitation for Blackwater, Brown Water, or for Excreta Treatment and Reuse in Developing Countries*. Gesellschaft für Internationale Zusammenarbeit (GIZ) GmbH, Eschborn, DE. Available at: www.susana.org/library
- Ulrich, A. (Ed.), Reuter, S. (Ed.), Gutterer, B. (Ed.), Sasse, L., Panzerbieter, T. and Reckerzügel, T. (2009). *Decentralised Wastewater Treatment Systems (DEWATS) and Sanitation in Developing Countries. A Practical Guide*. WEDC, Loughborough University, Leicestershire, UK.
- Vögeli, Y., Lohri, C. R., Gallardo, A., Diener, S. and Zurbrügg, C. (2014). *Anaerobic Digestion of Biowaste in Developing Countries. Practical Information and Case Studies*. Eawag (Department Sandec), Dübendorf, CH. Available at: www.sandec.ch

The technologies in this section deal with the products generated at the User Interface or onsite Collection and Storage/Treatment technology by removing and/or transporting them to a subsequent offsite (Semi-) Centralized Treatment, Use and/or Disposal technology. They are either sewer-based technologies (C.4-C.6), or container-based motorized/human-powered emptying and transport technologies (C.1-C.3, C.7).

- C.1 Jerrycan/Tank
- C.2 Human-Powered Emptying and Transport
- C.3 Motorized Emptying and Transport
- C.4 Simplified Sewer
- C.5 Solids-Free Sewer
- C.6 Conventional Gravity Sewer
- C.7 Transfer Station (Underground Holding Tank)

In any given context, the technology choice generally depends on the following factors:

- Type and quantity of products to be transported
- Distance to cover
- Accessibility
- Topography
- Soil and groundwater characteristics
- Financial resources
- Availability of a service provider
- Management considerations



Application Level:

- Household
 Neighbourhood
 City

Management Level:

- Household
 Shared
 Public

Inputs/Outputs:

- Urine Stored Urine

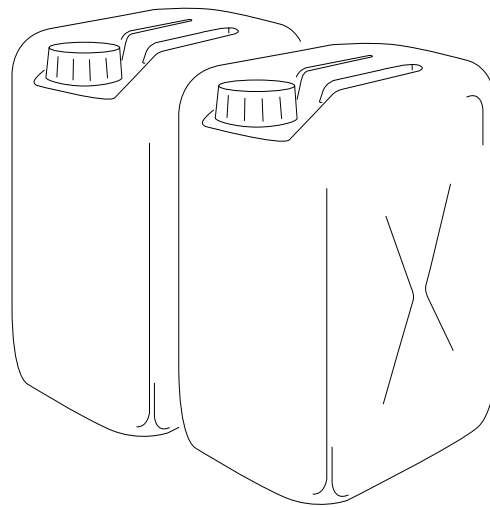

Jerrycans are light, plastic containers that are readily available and can be easily carried by one person. When sealed, they can be used to safely store or transport urine.

Urine can be collected in jerrycans or they can be filled with the urine stored in Storage Tanks/Containers (S.1) for transportation to agricultural fields or to a central storage facility. Where urine-diversion systems are common, a micro-enterprise may specialize in the collection and transport of jerrycans, using e.g., bicycles, donkeys, carts or small trucks.

Design Considerations On average, a person generates about 1.2 L of urine a day; however, this quantity may vary significantly depending on climate and fluid consumption. A family of 5 can be expected to fill a 20 L jerrycan with urine in approximately 3 to 4 days. It can either be stored on site or immediately transported. If the jerrycan is directly connected to the toilet or urinal with a pipe, care should be taken to minimize its length since precipitates will accumulate. Pipes should have a steep slope (> 1%), no sharp angles, and large diameters. They should be easily accessible in case of blockages.

Because jerrycans quickly fill up and need to be frequently exchanged or emptied, the use of a large Storage Tank/Container should be considered for primary collection of the urine. The stored urine can then be filled into jerrycans (e.g., using a small pump) and transported to the fields.

Appropriateness A well-sealed jerrycan is an effective way of transporting urine over short distances. It is inexpensive, easy to clean and re-useable. This type of transport is only appropriate for areas where the points of generation and use (i.e., homes and fields) are close together, and where relatively small quantities of urine are produced. Otherwise, a more formalized and efficient collection and distribution system is necessary. For compounds or communities with urine-diverting systems, for example, it may be more appropriate to have a large urine storage tank that can be emptied by such means as Motorized Emptying and Transport (C.3).

Jerrycans can be used in cold environments (where urine freezes) as long as they are not completely filled. In warmer months the stored urine can be used when it is needed for agriculture.

Health Aspects/Acceptance The people who exchange or empty jerrycans incur low health risks because urine is normally sterile. Carrying jerrycans also poses little health risk as they seal very well. While carrying a jerrycan may not be the most pleasant activity, it is likely to be more convenient and less costly than emptying a pit.

In some locations, urine has an economic value and it may be collected from households for free. Families who invest the time to transport and use their own urine may be rewarded with increased agricultural production, improving their nutrition and/or increasing their income.

Operation & Maintenance To minimize bacterial growth, sludge accumulation and unpleasant odours, jerrycans should be frequently washed. Because of safety concerns and transportation difficulties, no other liquids (such as blackwater or greywater) should be transported in jerrycans.

Pros & Cons

- + Jerrycans are widely available and robust
- + Very low capital and operating costs
- + Potential for local job creation and income generation
- + Easy to clean and reusable
- + Low risk of pathogen transmission
- Heavy to carry
- Spills may happen
- Mild to strong odour when filling and emptying jerrycans (depending on storage conditions)

References & Further Reading

- von Münch, E. and Winker, M. (2011). *Technology Review of Urine Diversion Components. Overview of Urine Diversion Components Such as Waterless Urinals, Urine Diversion Toilets, Urine Storage and Reuse Systems*. Gesellschaft für Internationale Zusammenarbeit (GIZ) GmbH, Eschborn, DE. Available at: www.susana.org/library
- Richert, A., Gensch, R., Jönsson, H., Stenström, T. A., and Dagerskog, L. (2010). *Practical Guidance on the Use of Urine in Crop Production*. EcoSanRes, Stockholm Environment Institute, Stockholm, SE. Available at: www.susana.org/library
- Rieck, C., von Münch, E. and Hoffmann, H. (2012). *Technology Review of Urine-Diverting Dry Toilets (UDDTs). Overview of Design, Operation, Management and Costs*. Deutsche Gesellschaft für Internationale Zusammenarbeit (GIZ) GmbH, Eschborn, DE. Available at: www.susana.org/library
- WHO (2006). *Guidelines for the Safe Use of Wastewater, Excreta and Greywater. Volume 4: Excreta and Greywater Use in Agriculture*. World Health Organization, Geneva, CH. Available at: www.who.int

Application Level:	Management Level:	Inputs/Outputs:
<ul style="list-style-type: none"> ★★ Household ★★ Neighbourhood □ City 	<ul style="list-style-type: none"> ★★ Household ★★ Shared ★★ Public 	<ul style="list-style-type: none"> ■ Sludge ■ Dried Faeces ■ Compost ■ Pit Humus

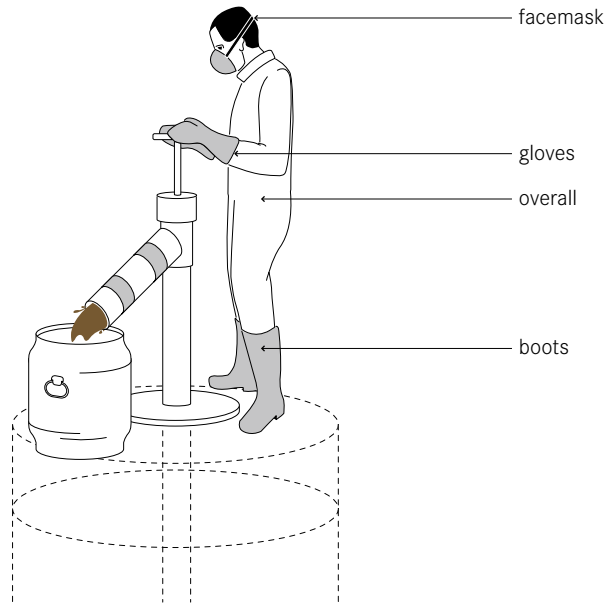
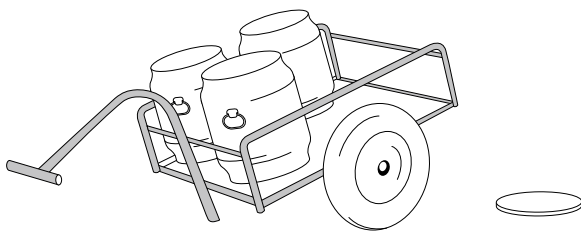

Human-powered emptying and transport refers to the different ways by which people can manually empty and/or transport sludge and solid products generated in onsite sanitation facilities.

Human-powered emptying of pits, vaults and tanks can be done in one of two ways:

- 1) using buckets and shovels, or
- 2) using a portable, manually operated pump specially designed for sludge (e.g., the Gulper, the Rammer, the MDHP or the MAPET).

Some sanitation technologies can only be emptied manually, for example, the Fossa Alterna (S.5) or Dehydration Vaults (S.7). These technologies must be emptied with a shovel because the material is solid and cannot be removed with a vacuum or a pump.

When sludge is viscous or watery it should be emptied with a hand pump or a vacuum truck, and not with buckets because of the high risk of collapsing pits, toxic fumes, and exposure to unsanitized sludge.

Manual sludge pumps are relatively new inventions and have shown promise as being low-cost, effective solutions for sludge emptying where, because of access, safety or economics, other emptying techniques are not possible.

Design Considerations Sludge hand pumps, such as the Gulper, work on the same concept as water hand pumps: the bottom of the pipe is lowered into the pit/tank while the operator remains at the surface. As the operator pushes and pulls the handle, the sludge is pumped up and is then discharged through the discharge spout. The sludge can be collected in barrels, bags or carts, and removed from the site with little danger to the operator. Hand pumps can be locally made with steel rods and valves in a PVC casing.

A MAPET (MAnual Pit Emptying Technology) consists of a manually operated pump connected to a vacuum tank mounted on a pushcart. A hose is connected to the tank and is used to suck sludge from the pit. When the wheel of the hand pump is turned, air is sucked out of the vacuum tank and sludge is sucked up into the tank. Depending on the consistency of the sludge, the MAPET can pump up to a height of 3 m.

Appropriateness Hand pumps can be used for liquid and, to a certain degree, viscous sludge. Domestic refuse in the pit makes emptying much more difficult. The pumping of sludge, which contains coarse solid wastes or grease, can lead to clogging of the device, and

chemical additives can corrode pipes, pumps and tanks. The hand pump is a significant improvement over the bucket method and could prove to be a sustainable business opportunity in some regions. Manually operated sludge pumps are appropriate for areas that are not served or not accessible by vacuum trucks, or where vacuum truck emptying is too costly. They are well suited to dense, urban and informal settlements, although the type and size of transport vehicle determines the feasible distance to the discharge point. Large vehicles may not be able to manoeuvre within narrow streets and alleys, while smaller vehicles may not be able to travel long distances. These technologies are more feasible when there is a Transfer Station (C.7) nearby.

Health Aspects/Acceptance Depending on cultural factors and political support, workers dealing with manual emptying may be viewed as providing an important service to the community. Government-run programmes should strive to legitimize the work of the labourers and create an enabling environment by providing permits and licences, as well as helping to legalize the practice of emptying latrines manually. The most important aspect of manual emptying is ensuring that workers are adequately protected with gloves, boots, overalls and facemasks. Regular medical exams and vaccinations should be required for everyone working with sludge.

Operation & Maintenance It is a common practice to add chemicals or oil during the pit emptying process to avoid odours. This is not recommended, however, because it causes difficulties in the subsequent treatment units, as well as additional health threats to the workers. If manual access to the contents of a pit requires demolishing the slab, it may be more cost-effective to use a manual sludge pump to empty the latrine. However, hand pumps cannot empty the entire pit and, therefore, emptying may be required more frequently (once a year). Manually operated sludge pumps require daily maintenance (cleaning, repairing and disinfection). Workers who manually empty latrines should clean and maintain their protective clothing and tools to prevent contact with the sludge.

Pros & Cons

- + Potential for local job creation and income generation
- + Simple hand pumps can be built and repaired with locally available materials
- + Low capital costs; variable operating costs depending on transport distance
- + Provides services to areas/communities without sewers
- Spills can happen which could pose potential health risks and generate offensive smells
- Time consuming: emptying pits out can take several hours/days depending on their size
- Garbage in pits may block pipe
- Some devices may require specialized repair (welding)

References & Further Reading

- Eales, K. (2005). *Bringing Pit Emptying out of the Darkness: A Comparison of Approaches in Durban, South Africa, and Kibera, Kenya*. Building Partnerships for Development in Water and Sanitation, London, UK.
Available at: www.bpdws.org
(A comparison of two manual emptying projects)
- Ideas at Work (2007). *The 'Gulper' - a Manual Latrine/Drain Pit Pump*. Ideas at Work, Phnom Penh, KH.
Available at: www.ideas-at-work.org
(Case study about a test of the Gulper by informal service providers)
- Muller, M. and Rijnsburger, J. (1994). *MAPET. Manual Pit-latrine Emptying Technology Project. Development and Pilot Implementation of a Neighbourhood Based Pit Emptying Service with Locally Manufactured Handpump Equipment in Dar es Salaam, Tanzania*. 1988-1992. WASTE Consultants, Gouda, NL.
Available at: www.washdoc.info
- Oxfam (2008). *Manual Desludging Hand Pump (MDHP) Resources*. Oxfam GB, Oxford, UK.
Available at: www.desludging.org
(Manual for the MDHP)
- Pickford, J. and Shaw, R. (1997). *Technical Brief No. 54: Emptying Pit Latrines*. WEDC, Loughborough University, Leicestershire, UK.
Available at: www.lboro.ac.uk/well

Application Level:

- ★★ Household
- ★★ Neighbourhood
- ★ City

Management Level:

- Household
- ★ Shared
- ★★ Public

Inputs/Outputs:

- Sludge
- Blackwater
- Effluent
- Urine
- Stored Urine

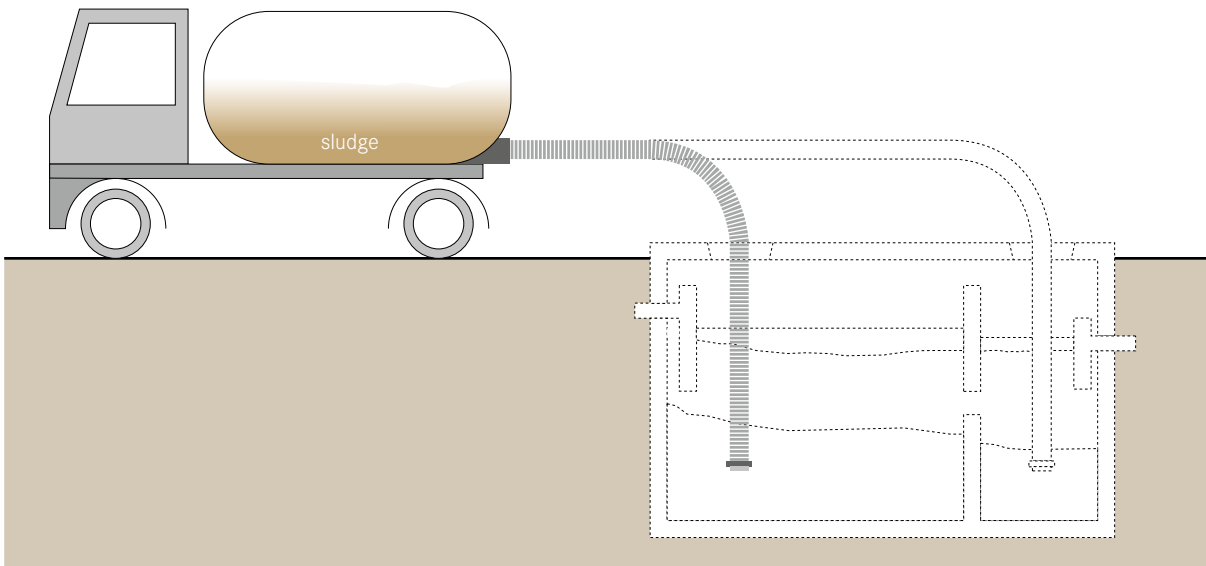

Motorized emptying and transport refers to a vehicle equipped with a motorized pump and a storage tank for emptying and transporting faecal sludge and urine. Humans are required to operate the pump and manoeuvre the hose, but sludge is not manually lifted or transported.

A truck is fitted with a pump which is connected to a hose that is lowered down into a tank (e.g., Septic Tank, S.9) or pit, and the sludge is pumped up into the holding tank on the vehicle. This type of design is often referred to as a vacuum truck.

Alternative motorized vehicles or machines have been developed for densely populated areas with limited access. Designs such as the Vacutug, Dung Beetle, Molsta or Kedoteng carry a small sludge tank and a pump and can negotiate narrow pathways.

Design Considerations Generally, the storage capacity of a vacuum truck is between 3 and 12 m³. Local trucks are commonly adapted for sludge transport by equipping them with holding tanks and pumps. Modified pick-ups and tractor trailers can transport around 1.5 m³, but capacities vary. Smaller vehicles for densely populat-

ed areas have capacities of 500 to 800 L. These vehicles use, for example, two-wheel tractor or motorcycle based drives and can reach speeds of up to 12 km/h. Pumps can usually only suck down to a depth of 2 to 3 m (depending on the strength of the pump) and must be located within 30 m of the pit. In general, the closer the vacuum pump can be to the pit, the easier it is to empty.

Appropriateness Depending on the Collection and Storage technology, the sludge can be so dense that it cannot be easily pumped. In these situations it is necessary to thin the solids with water so that they flow more easily, but this may be inefficient and costly. Garbage and sand make emptying much more difficult and clog the pipe or pump. Multiple truckloads may be required for large Septic Tanks.

Although large vacuum trucks cannot access areas with narrow or non-driveable roads, they remain the norm for municipalities and sanitation authorities. These trucks can rarely make trips to remote areas (e.g., in the periphery of a city) since the income generated may not offset the cost of fuel and time. Therefore, the treatment site must be within reach from the serviced areas. Transfer Stations (C.7) and adequate treatment are also

crucial for service providers using small-scale motorized equipment. Field experiences have shown that the existing designs for dense urban areas are limited in terms of their emptying effectiveness and travel speed, and their ability to negotiate slopes, poor roads and very narrow lanes. Moreover, demand and market constraints have prevented them from becoming commercially viable. Under favourable circumstances, small vehicles like the Vacutug are able to recover the operating and maintenance costs. However, the capital costs are still too high to sustainably run a profitable business.

Both the sanitation authority and private entrepreneurs may operate vacuum trucks, although the price and level of service may vary significantly. Private operators may charge less than public ones, but may only afford to do so if they do not discharge the sludge at a certified facility. Private and municipal service providers should work together to cover the whole faecal sludge management chain.

Health Aspects/Acceptance The use of a vacuum truck presents a significant health improvement over manual emptying and helps to maintain the Collection and Storage technology. Still, truck operators are not always accepted by the community and may face difficulties with finding appropriate locations to dump the collected sludge.

Operation & Maintenance Most pump trucks are manufactured in North America, Asia or Europe. Thus, in some regions it is difficult to locate spare parts and a mechanic to repair broken pumps or trucks. New trucks are very expensive and sometimes difficult to obtain. Therefore, older trucks are often used, but the savings are offset by the resulting high maintenance and fuel costs that can account for more than two thirds of the total costs incurred by a truck operator. Truck owners must be conscientious to save money for the purchase of expensive replacement parts, tires and equipment. The lack of preventive maintenance is often the cause for major repairs.

The addition of chemical additives for desludging is not recommended because they tend to corrode the sludge tank.

Pros & Cons

- + Fast, hygienic and generally effective sludge removal
- + Efficient transport possible with large vacuum trucks
- + Potential for local job creation and income generation
- + Provides an essential service to unsewered areas
- Cannot pump thick, dried sludge (must be thinned with water or manually removed)
- Garbage in pits may block hose
- Cannot completely empty deep pits due to limited suction lift
- Very high capital costs; variable operating costs depending on use and maintenance
- Hiring a vacuum truck may be unaffordable for poor households
- Not all parts and materials may be locally available
- May have difficulties with access

References & Further Reading

- Boesch, A. and Schertenleib, R. (1985). *Pit Emptying on-Site Excreta Disposal Systems. Field Tests with Mechanized Equipment in Gaborone (Botswana)*. International Reference Centre for Waste Disposal, Dübendorf, CH.
Available at: www.sandec.ch
(Comprehensive summary of technical components, performance with different sludge types, and maintenance)
- Chowdhry, S. and Koné, D. (2012). *Business Analysis of Fecal Sludge Management: Emptying and Transportation Services in Africa and Asia*. Bill & Melinda Gates Foundation, Seattle, US.
Available at: www.susana.org/library
- O’Riordan, M. (2009). *Investigation into Methods of Pit Latrine Emptying. Management of Sludge Accumulation in VIP Latrines*. WRC Project 1745, Water Research Commission, Pretoria, ZA.
Available at: www.susana.org/library
(Includes a detailed analysis of field experiences with the Vacutug)
- Strande, L., Ronteltap, M. and Brdjanovic, D. (Eds.) (2014). *Faecal Sludge Management. Systems Approach for Implementation and Operation*. IWA Publishing, London, UK.
Available at: www.sandec.ch
(Detailed book compiling the current state of knowledge on all aspects related to FSM)

Application Level:

- Household
 Neighbourhood
 City

Management Level:

- Household
 Shared
 Public

Inputs/Outputs:

- Blackwater Brownwater
 Greywater Effluent

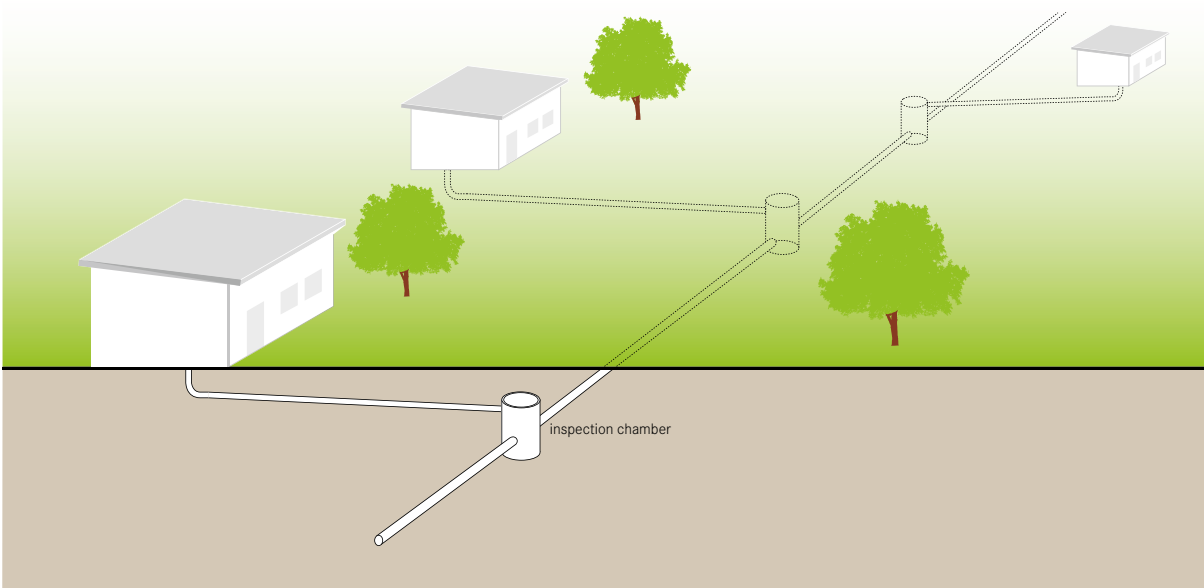

A simplified sewer describes a sewerage network that is constructed using smaller diameter pipes laid at a shallower depth and at a flatter gradient than Conventional Sewers (C.6). The simplified sewer allows for a more flexible design at lower costs.

Conceptually, simplified sewerage is the same as Conventional Gravity Sewerage, but without unnecessarily conservative design standards and with design features that are better adapted to the local situation. The pipes are usually laid within the property boundaries, through either the back or front yards, rather than beneath the central road, allowing for fewer and shorter pipes. Because simplified sewers are typically installed within the condominium, they are often referred to as condominium sewers. The pipes can also be routed in access ways, which are too narrow for heavy traffic, or underneath pavements (sidewalks). Since simplified sewers are installed where they are not subjected to heavy traffic loads, they can be laid at a shallow depth and little excavation is required.

Design Considerations In contrast to Conventional Sewers that are designed to ensure a minimum

self-cleansing velocity, the design of simplified sewers is based on a minimum tractive tension of 1 N/m^2 (1 Pa) at peak flow. The minimum peak flow should be 1.5 L/s and a minimum sewer diameter of 100 mm is required. A gradient of 0.5% is usually sufficient. For example, a 100 mm sewer laid at a gradient of 1 m in 200 m will serve around 2,800 users with a wastewater flow of 60 L/person/day.

PVC pipes are recommended to use. The depth at which they should be laid depends mainly on the amount of traffic. Below sidewalks, covers of 40 to 65 cm are typical. The simplified design can also be applied to sewer mains; they can also be laid at a shallow depth, provided that they are placed away from traffic.

Expensive manholes are normally not needed. At each junction or change in direction, simple inspection chambers (or cleanouts) are sufficient. Inspection boxes are also used at each house connection. Where kitchen greywater contains an appreciable amount of oil and grease, the installation of grease traps (see PRE, p. 100) is recommended to prevent clogging.

Greywater should be discharged into the sewer to ensure adequate hydraulic loading, but stormwater connections should be discouraged. However, in practice

it is difficult to exclude all stormwater flows, especially where there is no alternative for storm drainage. The design of the sewers (and treatment plant) should, therefore, take into account the extra flow that may result from stormwater inflow.

Appropriateness Simplified sewers can be installed in almost all types of settlements and are especially appropriate for dense urban areas where space for onsite technologies is limited. They should be considered as an option where there is a sufficient population density (about 150 people per hectare) and a reliable water supply (at least 60 L/person/day).

Where the ground is rocky or the groundwater table high, excavation may be difficult. Under these circumstances, the cost of installing sewers is significantly higher than in favourable conditions. Regardless, simplified sewerage is between 20 and 50% less expensive than Conventional Sewerage.

Health Aspects/Acceptance If well constructed and maintained, sewers are a safe and hygienic means of transporting wastewater. Users must be well trained regarding the health risks associated with removing blockages and maintaining inspection chambers.

Operation & Maintenance Trained and responsible users are essential to ensure that the flow is undisturbed and to avoid clogging by trash and other solids. Occasional flushing of the pipes is recommended to insure against blockages. Blockages can usually be removed by opening the cleanouts and forcing a rigid wire through the pipe. Inspection chambers must be periodically emptied to prevent grit overflowing into the system. The operation of the system depends on clearly defined responsibilities between the sewerage authority and the community. Ideally, households will be responsible for the maintenance of pre-treatment units and the condominial part of the sewer. However, in practice this may not be feasible because users may not detect problems before they become severe and costly to repair. Alternatively, a private contractor or users committee can be hired to do the maintenance.

Pros & Cons

- + Can be laid at a shallower depth and flatter gradient than Conventional Sewers
- + Lower capital costs than Conventional Sewers; low operating costs
- + Can be extended as a community grows
- + Greywater can be managed concurrently
- + Does not require onsite primary treatment units
- Requires repairs and removals of blockages more frequently than a Conventional Gravity Sewer
- Requires expert design and construction
- Leakages pose a risk of wastewater exfiltration and groundwater infiltration and are difficult to identify

References & Further Reading

- Bakalian, A., Wright, A., Otis, R. and Azevedo Netto, J. (1994). *Simplified Sewerage: Design Guidelines*. UNDP-World Bank Water and Sanitation Program, Washington, D.C., US. Available at: documents.worldbank.org/curated/en/home (Design guidelines for manual calculations)
- Mara, D. D. (1996a). *Low-Cost Sewerage*. Wiley, Chichester, UK. (Assessment of different low-cost systems and case studies)
- Mara, D. D. (1996b). *Low-Cost Urban Sanitation*. Wiley, Chichester, UK. pp. 109-139. (Comprehensive summary including design examples)
- Mara, D. D. (2005). *Sanitation for All in Periurban Areas? Only If We Use Simplified Sewerage*. *Water Science & Technology: Water Supply* 5 (6): 57-65. (An article summarizing the technology and its potential role in urban sanitation)
- Mara, D. D., Sleight, A. and Tayler, K. (2001). *PC-Based Simplified Sewer Design*. University of Leeds, Leeds, UK. Available at: www.efm.leeds.ac.uk/CIVE/Sewerage/ (Comprehensive coverage of theory and design including a program to be used as a design aid)
- Watson, G. (1995). *Good Sewers Cheap? Agency-Customer Interactions in Low-Cost Urban Sanitation in Brazil*. Water and Sanitation Division, The World Bank, Washington, D.C., US. Available at: www.wsp.org (A summary of large-scale projects in Brazil)

Application Level:	Management Level:	Inputs/Outputs:
<input type="checkbox"/> Household <input checked="" type="checkbox"/> Neighbourhood <input checked="" type="checkbox"/> City	<input checked="" type="checkbox"/> Household <input checked="" type="checkbox"/> Shared <input checked="" type="checkbox"/> Public	<input checked="" type="checkbox"/> Effluent

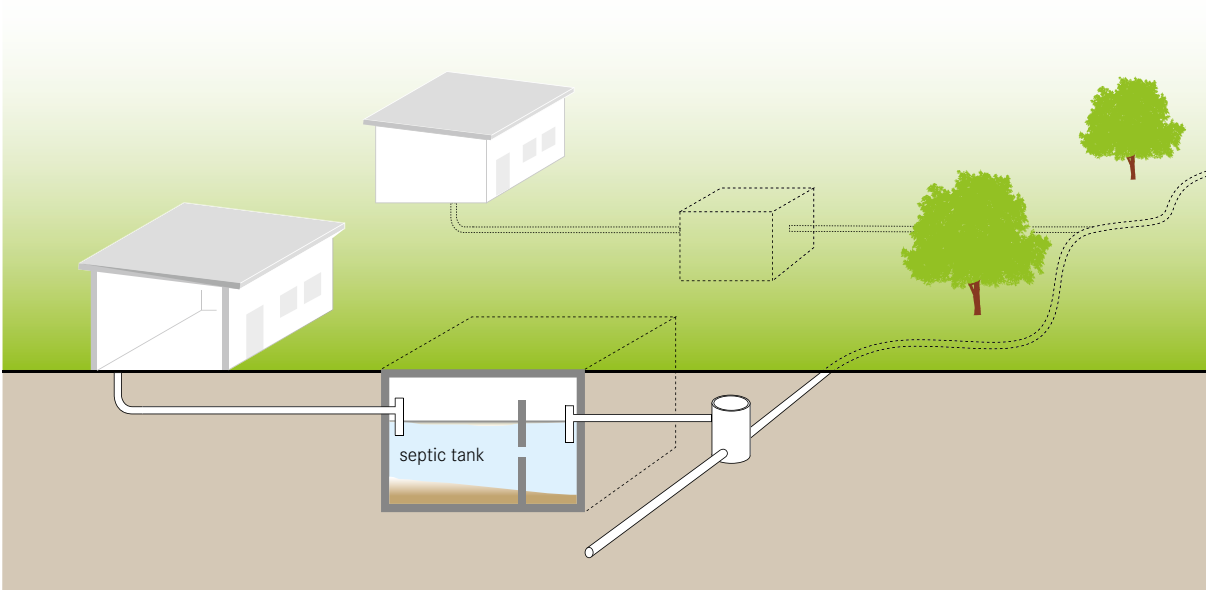

A solids-free sewer is a network of small-diameter pipes that transports pre-treated and solids-free wastewater (such as Septic Tank effluent). It can be installed at a shallow depth and does not require a minimum wastewater flow or slope to function.

Solids-free sewers are also referred to as settled, small-bore, variable-grade gravity, or septic tank effluent gravity sewers. A precondition for solids-free sewers is efficient primary treatment at the household level. An interceptor, typically a single-chamber Septic Tank (S.9), captures settleable particles that could clog small pipes. The solids interceptor also functions to attenuate peak discharges. Because there is little risk of depositions and clogging, solids-free sewers do not have to be self-cleansing, i.e., no minimum flow velocity or tractive tension is needed. They require few inspection points, can have inflective gradients (i.e., negative slopes) and follow the topography. When the sewer roughly follows the ground contours, the flow is allowed to vary between open channel and pressure (full-bore) flow.

Design Considerations If the interceptors are correctly designed and operated, this type of sewer

does not require self-cleansing velocities or minimum slopes. Even inflective gradients are possible, as long as the downstream end of the sewer is lower than the upstream end. In sections where there is pressure flow, the water level in any interceptor tank must be higher than the hydraulic head within the sewer, otherwise the liquid will flow back into the tank. At high points in sections with pressure flow, the pipes must be ventilated. Solids-free sewers do not have to be installed on a uniform gradient with a straight alignment between inspection points. The alignment may curve to avoid obstacles, allowing for greater construction tolerance. A minimum diameter of 75 mm is required to facilitate cleaning. Expensive manholes are not needed because access for mechanical cleaning equipment is not necessary. Cleanouts or flushing points are sufficient and are installed at upstream ends, high points, intersections, or major changes in direction or pipe size. Compared to manholes, cleanouts can be more tightly sealed to prevent stormwater from entering. Stormwater must be excluded as it could exceed pipe capacity and lead to blockages due to grit depositions. Ideally, there should not be any storm- and groundwater in the sewers, but, in practice, some

imperfectly sealed pipe joints must be expected. Estimates of groundwater infiltration and stormwater inflow must, therefore, be made when designing the system. The use of PVC pipes can minimize the risk of leakages.

Appropriateness This type of sewer is best suited to medium-density (peri-)urban areas and less appropriate in low-density or rural settings. It is most appropriate where there is no space for a Leach Field (D.8), or where effluents cannot otherwise be disposed of onsite (e.g., due to low infiltration capacity or high groundwater). It is also suitable where there is undulating terrain or rocky soil. A solids-free sewer can be connected to existing Septic Tanks where infiltration is no longer appropriate (e.g., due to increased housing density and/or water use).

As opposed to a Simplified Sewer (C.4) a solids-free sewer can also be used where domestic water consumption is limited.

This technology is a flexible option that can be easily extended as the population grows. Because of shallow excavations and the use of fewer materials, it can be built at considerably lower cost than a Conventional Sewer (C.6).

Health Aspects/Acceptance If well constructed and maintained, sewers are a safe and hygienic means of transporting wastewater. Users must be well trained regarding the health risks associated with removing blockages and maintaining interceptor tanks.

Operation & Maintenance Trained and responsible users are essential to avoid clogging by trash and other solids. Regular desludging of the Septic Tanks is critical to ensure optimal performance of the sewer. Periodic flushing of the pipes is recommended to insure against blockages.

Special precautions should be taken to prevent illegal connections, since it is likely that interceptors would not be installed and solids would enter the system.

The sewerage authority, a private contractor or users committee should be responsible for the management of the system, particularly, to ensure that the inter-

ceptors are regularly deslugged and to prevent illegal connections.

Pros & Cons

- + Does not require a minimum gradient or flow velocity
- + Can be used where water supply is limited
- + Lower capital costs than conventional gravity sewers; low operating costs
- + Can be extended as a community grows
- + Greywater can be managed concurrently
- Space for interceptors is required
- Interceptors require regular desludging to prevent clogging
- Requires training and acceptance to be used correctly
- Requires repairs and removals of blockages more frequently than a conventional gravity sewer
- Requires expert design and construction
- Leakages pose a risk of wastewater exfiltration and groundwater infiltration and are difficult to identify

References & Further Reading

- Azevedo Netto, J. and Reid, R. (1992). *Innovative and Low-Cost Technologies Utilized in Sewerage*. Technical Series No. 29, Environmental Health Program, Pan American Health Organization, Washington, D.C., US.
(A short summary and component diagrams – Chapter 5)
- Crites, R. and Tchobanoglous, G. (1998). *Small and Decentralized Wastewater Management Systems*. WCB/McGraw-Hill, New York, US. pp. 355-364.
(A short summary of design and construction considerations)
- Mara, D. D. (1996a). *Low-Cost Sewerage*. Wiley, Chichester, UK.
(Assessment of different low-cost systems and case studies)
- Mara, D. D. (1996b). *Low-Cost Urban Sanitation*. Wiley, Chichester, UK. pp. 93-108.
(Comprehensive summary including design examples)
- Otis, R. J. and Mara, D. D. (1985). *The Design of Small Bore Sewer Systems*. UNDP Interregional Project INT/81/047, The World Bank and UNDP, Washington, D.C., US.
Available at: documents.worldbank.org/curated/en/home
(Comprehensive summary of design, installation and maintenance)

Application Level:

- Household
 Neighbourhood
 City

Management Level:

- Household
 Shared
 Public

Inputs/Outputs:

- Blackwater Brownwater
 Greywater Stormwater

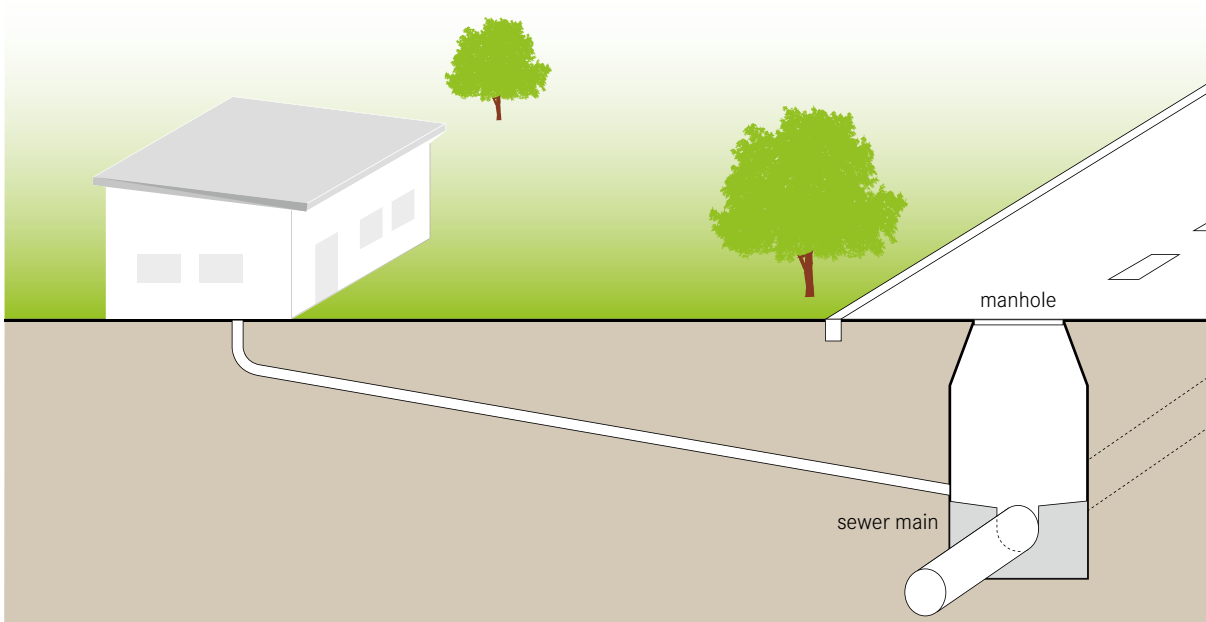

Conventional gravity sewers are large networks of underground pipes that convey blackwater, greywater and, in many cases, stormwater from individual households to a (Semi-) Centralized Treatment facility, using gravity (and pumps when necessary).

The conventional gravity sewer system is designed with many branches. Typically, the network is subdivided into primary (main sewer lines along main roads), secondary and tertiary networks (networks at the neighbourhood and household level).

Design Considerations Conventional gravity sewers normally do not require onsite pre-treatment, primary treatment or storage of the household wastewater before it is discharged. The sewer must be designed, however, so that it maintains self-cleansing velocity (i.e., a flow that will not allow particles to accumulate). For typical sewer diameters, a minimum velocity of 0.6 to 0.7 m/s during peak dry weather conditions should be adopted. A constant downhill gradient must be guaranteed along the length of the sewer to maintain self-cleansing flows, which can require deep excavations. When a downhill grade cannot be maintained, a

pumping station must be installed. Primary sewers are laid beneath roads, at depths of 1.5 to 3 m to avoid damages caused by traffic loads. The depth also depends on the groundwater table, the lowest point to be served (e.g., a basement) and the topography. The selection of the pipe diameter depends on the projected average and peak flows. Commonly used materials are concrete, PVC, and ductile or cast iron pipes.

Access manholes are placed at set intervals above the sewer, at pipe intersections and at changes in pipeline direction (vertically and horizontally). Manholes should be designed such that they do not become a source of stormwater inflow or groundwater infiltration.

In the case that connected users discharge highly polluted wastewater (e.g., industry or restaurants), onsite pre- and primary treatment may be required before discharge into the sewer system to reduce the risk of clogging and the load of the wastewater treatment plant.

When the sewer also carries stormwater (known as a combined sewer), sewer overflows are required to avoid hydraulic surcharge of treatment plants during rain events. However, combined sewers should no longer be considered state of the art. Rather, local retention and infiltration of stormwater or a separate drainage system

for rainwater are recommended. The wastewater treatment system then requires smaller dimensions and is, therefore, cheaper to build, and there is a higher treatment efficiency for less diluted wastewater.

Appropriateness Because they can be designed to carry large volumes, conventional gravity sewers are very appropriate to transport wastewater to a (Semi-) Centralized Treatment facility. Planning, construction, operation and maintenance require expert knowledge. Construction of conventional sewer systems in dense, urban areas is complicated because it disrupts urban activities and traffic. Conventional gravity sewers are expensive to build and, because the installation of a sewer line is disruptive and requires extensive coordination between authorities, construction companies and property owners, a professional management system must be in place.

Ground shifting may cause cracks in manhole walls or pipe joints, which may become a source of groundwater infiltration or wastewater exfiltration, and compromise the performance of the sewer.

Conventional gravity sewers can be constructed in cold climates as they are dug deep into the ground and the large and constant water flow resists freezing.

Health Aspects/Acceptance If well constructed and maintained, sewers are a safe and hygienic means of transporting wastewater. This technology provides a high level of hygiene and comfort for the user. However, because the waste is conveyed to an offsite location for treatment, the ultimate health and environmental impacts are determined by the treatment provided by the downstream facility.

Operation & Maintenance Manholes are used for routine inspection and sewer cleaning. Debris (e.g., grit, sticks or rags) may accumulate in the manholes and block the lines. To avoid clogging caused by grease, it is important to inform the users about proper oil and grease disposal. Common cleaning methods for conventional gravity sewers include rodding, flushing, jetting and bailing. Sewers can be dangerous because of toxic gases and should be maintained only by professionals,

although, in well-organised communities, the maintenance of tertiary networks might be handed over to a well-trained group of community members. Proper protection should always be used when entering a sewer.

Pros & Cons

- + Less maintenance compared to Simplified and Solids-Free Sewers
- + Greywater and possibly stormwater can be managed concurrently
- + Can handle grit and other solids, as well as large volumes of flow
- Very high capital costs; high operation and maintenance costs
- A minimum velocity must be maintained to prevent the deposition of solids in the sewer
- Requires deep excavations
- Difficult and costly to extend as a community changes and grows
- Requires expert design, construction and maintenance
- Leakages pose a risk of wastewater exfiltration and groundwater infiltration and are difficult to identify

References & Further Reading

- Bizier, P. (Ed.) (2007). *Gravity Sanitary Sewer Design and Construction. Second Edition*. ASCE Manuals and Reports on Engineering Practice No. 60, WEF MOP No. FD-5. American Society of Civil Engineers, New York, US. (A standard design text used in North America, although local codes and standards should be assessed before choosing a design manual)
- Tchobanoglous, G. (1981). *Wastewater Engineering: Collection and Pumping of Wastewater*. McGraw-Hill, New York, US.
- U.S. EPA (2002). *Collection Systems Technology Fact Sheet. Sewers, Conventional Gravity*. 832-F-02-007. U.S. Environmental Protection Agency, Washington, D.C., US. Available at: www.epa.gov (Good description of the technology, including more detailed design criteria and information on operation and maintenance)

Application Level:	Management Level:	Inputs/Outputs:
<input type="checkbox"/> Household <input checked="" type="checkbox"/> Neighbourhood <input checked="" type="checkbox"/> City	<input type="checkbox"/> Household <input checked="" type="checkbox"/> Shared <input checked="" type="checkbox"/> Public	<input checked="" type="checkbox"/> Sludge

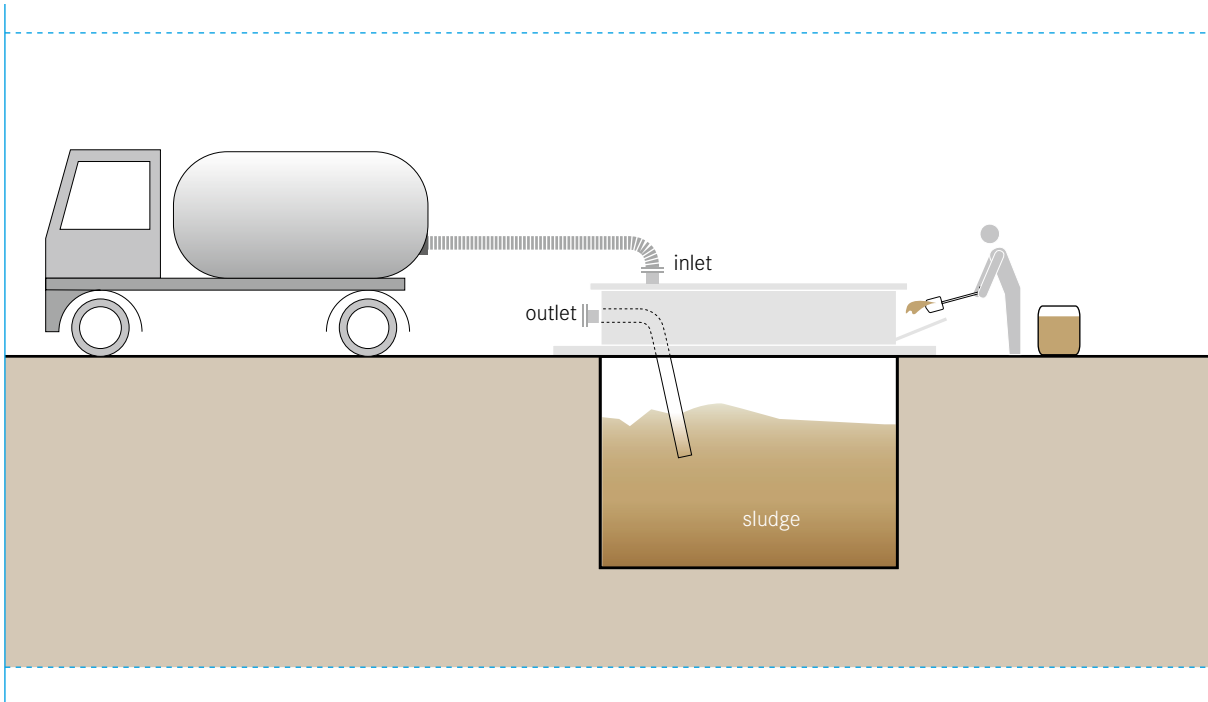

Transfer stations or underground holding tanks act as intermediate dumping points for faecal sludge when it cannot be easily transported to a (Semi-) Centralized Treatment facility. A vacuum truck is required to empty transfer stations when they are full.

Operators of Human-Powered or small-scale Motorized Sludge Emptying Equipment (see C.2 and C.3) discharge the sludge at a local transfer station rather than illegally dumping it or travelling to discharge it at a remote treatment or disposal site. When the transfer station is full, a vacuum truck empties the contents and takes the sludge to a suitable treatment facility. Municipalities or sewerage authorities may charge for permits to dump at the transfer station to offset the costs of operating and maintaining the facility.

In urban settings, transfer stations have to be carefully located, otherwise odours could become a nuisance, especially, if they are not well maintained.

Design Considerations A transfer station consists of a parking place for vacuum trucks or sludge carts, a connection point for discharge hoses, and a storage tank. The dumping point should be built low enough to

minimize spills when labourers manually empty their sludge carts. Additionally, the transfer station should include a vent, a trash screen to remove large debris (garbage) and a washing facility for vehicles. The holding tank must be well constructed to prevent leaching and/or surface water infiltration.

A variation is the sewer discharge station (SDS), which is like a transfer station, but is directly connected to a conventional gravity sewer main. Sludge emptied into the SDS is released into the sewer main either directly or at timed intervals (e.g., by pumping) to optimize the performance of the sewer and of the wastewater treatment plant, and/or reduce peak loads.

Transfer stations can be equipped with digital data recording devices to track quantity, input type and origin, as well as collect data about the individuals who dump there. In this way, the operator can collect detailed information and more accurately plan and adapt to differing loads.

The system for issuing permits or charging access fees must be carefully designed so that those who most need the service are not excluded because of high costs, while still generating enough income to sustainably operate and maintain the transfer stations.

Appropriateness Transfer stations are appropriate for dense, urban areas where there are no alternative discharge points for faecal sludge. Establishing multiple transfer stations may help to reduce the incidence of illegal sludge dumping and promote the emptying market.

Transfer stations are especially adequate where small-scale sludge emptying takes place. In big cities, they can reduce the costs incurred by truck operators by decreasing transport distances and waiting times in traffic jams. Local service providers can discharge sludge at transfer stations during the day, while large trucks can empty the tanks and go to the treatment plant at night when traffic is light.

Transfer stations should be located where they are easily accessible, convenient, and easy to use. Depending on their maintenance, odours could become a problem to local residents. However, the benefits gained from them compared to open-air illegal dumping greatly offset any nuisances.

Health Aspects/Acceptance Transfer stations have the potential to significantly increase the health of a community by providing an inexpensive, local solution for faecal sludge disposal. By providing a transfer station, independent or small-scale service providers are no longer forced to illegally dump sludge, and homeowners are more motivated to empty their pits. When pits are regularly emptied and illegal dumping is minimized, the overall health of a community can be significantly improved. The location must be carefully chosen to maximize efficiency and minimize odours and problems to nearby residents.

Operation & Maintenance Screens must be frequently cleaned to ensure a constant flow and prevent back-ups. Sand, grit and consolidated sludge must also be periodically removed from the holding tank. There should be a well-organized system to empty the transfer station; if the holding tank fills up and overflows, it is no better than an overflowing pit. The pad and loading area should be regularly cleaned to minimize odours, flies and other vectors from becoming nuisances.

Pros & Cons

- + Makes sludge transport to the treatment plant more efficient, especially where small-scale service providers with slow vehicles are involved
- + May reduce the illegal dumping of faecal sludge
- + Costs can be offset with access permits
- + Potential for local job creation and income generation
- Requires expert design and construction
- Can lead to odours if not properly maintained

References & Further Reading

- African Development Fund (2005). *Accra Sewerage Improvement Project (ASIP). Appraisal Report*. Infrastructure Department Central and West Regions. Abidjan, CI. Available at: www.afdb.org
- Boot, N. L. and Scott, R. E. (2008). *Faecal Sludge in Accra, Ghana: Problems of Urban Provision. Proceedings: Sanitation Challenge: New Sanitation Concepts and Models of Governance*. Wageningen, NL.
- Chowdhry, S. and Koné, D. (2012). *Business Analysis of Faecal Sludge Management: Emptying and Transportation Services in Africa and Asia*. Bill & Melinda Gates Foundation, Seattle, US. Available at: www.susana.org/library
- Strande, L., Ronteltap, M. and Brdjanovic, D. (Eds.) (2014). *Faecal Sludge Management. Systems Approach for Implementation and Operation*. IWA Publishing, London, UK. Available at: www.sandec.ch
- U.S. EPA (1994). *Guide to Septage Treatment and Disposal*. EPA/625/R-94/002. U.S. Environmental Protection Agency, Office of Research and Development, OH, US. Available at: www.epa.gov

This section describes the treatment technologies generally appropriate for large user groups (i.e., from semi-centralized applications at the neighbourhood level to centralized, city level applications). They are designed to accommodate increased volumes of flow and provide, in most cases, improved removal of nutrients, organics and pathogens, especially when compared with small household-level treatment technologies (S). However, the operation, maintenance, and energy requirements of the technologies within this functional group are generally higher than for smaller-scale technologies at the S level.

The technologies are divided into two groups: T.1-T.12 are primarily for the treatment of Blackwater, Brownwater, Greywater or Effluent, whereas T.13-T.17 are mainly for the treatment of Sludge. Technologies for pre-treatment and post-treatment are also described (technology information sheets PRE and POST), even though they are not always required.

PRE	Pre-Treatment Technologies	
T.1	Settler	} T.1-T.12 Technologies for the treatment of Blackwater, Brownwater, Greywater or Effluent
T.2	Imhoff Tank	
T.3	Anaerobic Baffled Reactor (ABR)	
T.4	Anaerobic Filter	
T.5	Waste Stabilization Ponds (WSP)	
T.6	Aerated Pond	
T.7	Free-Water Surface Constructed Wetland	
T.8	Horizontal Subsurface Flow Constructed Wetland	
T.9	Vertical Flow Constructed Wetland	
T.10	Trickling Filter	
T.11	Upflow Anaerobic Sludge Blanket Reactor (UASB)	
T.12	Activated Sludge	
T.13	Sedimentation/Thickening Ponds	} T.13-T.17 Technologies for the treatment of Sludge
T.14	Unplanted Drying Beds	
T.15	Planted Drying Beds	
T.16	Co-Composting	
T.17	Biogas Reactor	
POST	Tertiary Filtration and Disinfection	

When designing a (Semi-) Centralized Treatment scheme, the engineer must create a meaningful combination of these technologies in order to achieve the desired overall treatment objective (e.g., a multiple-stage configuration for pre-treatment, primary treatment and secondary treatment).

In any given context, the technology choice generally depends on the following factors:

- Type and quantity of products to be treated (including future developments)
- Desired output product (end-use and/or legal quality requirements)
- Financial resources
- Local availability of materials
- Availability of space
- Soil and groundwater characteristics
- Availability of a constant source of electricity
- Skills and capacity (for design and operation)
- Management considerations

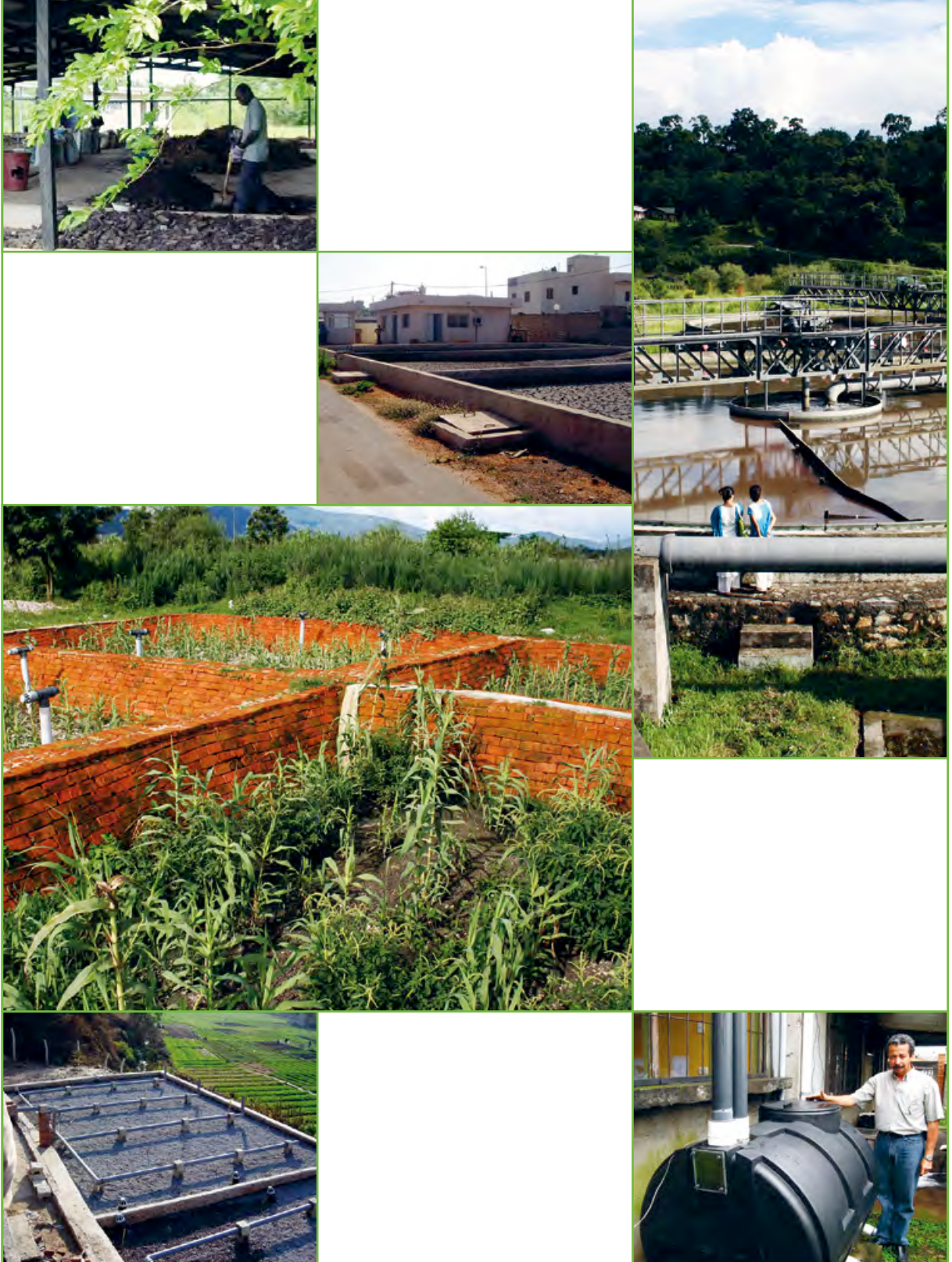

Application Level: <input type="checkbox"/> Household <input checked="" type="checkbox"/> Neighbourhood <input checked="" type="checkbox"/> City	Management Level: <input type="checkbox"/> Household <input checked="" type="checkbox"/> Shared <input checked="" type="checkbox"/> Public	Inputs: Blackwater Brownwater Greywater Sludge
		Outputs: Blackwater Brownwater Greywater Sludge Pre-Treatment Products

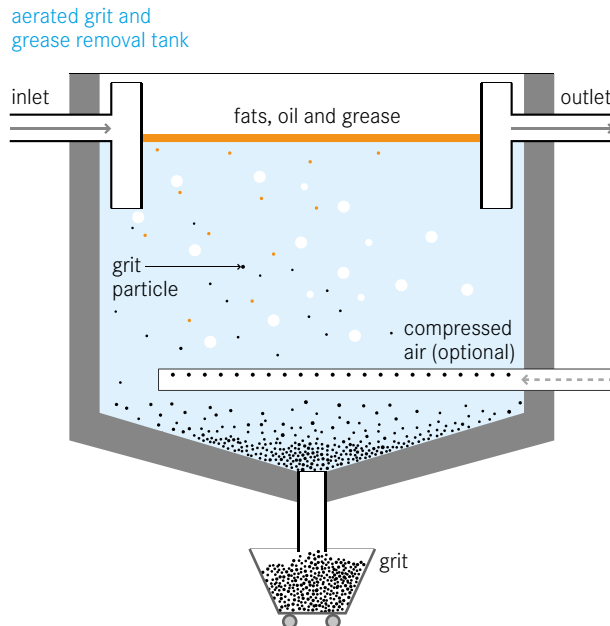
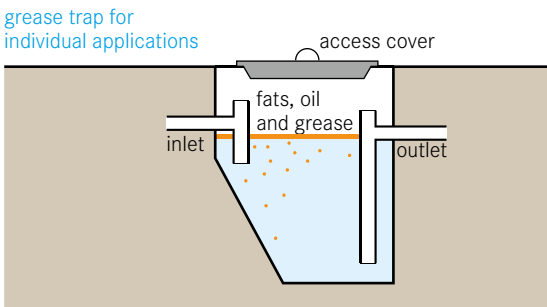
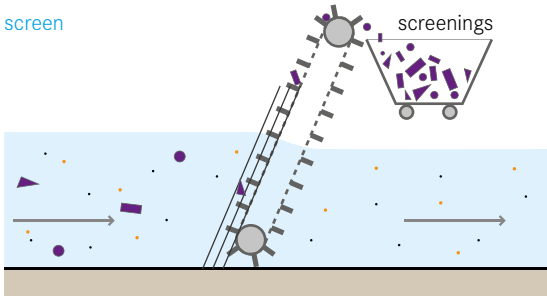

Pre-treatment is the preliminary removal of wastewater or sludge constituents, such as oil, grease, and various solids (e.g., sand, fibres and trash). Built before a Conveyance or Treatment technology, pre-treatment units can retard the accumulation of solids and minimize subsequent blockages. They can also help reduce abrasion of mechanical parts and extend the life of the sanitation infrastructure.

Oil, grease, sand and suspended solids can impair transport and/or treatment efficiency through clogging and wear. Therefore, prevention and early removal of these substances is crucial for the durability of a treatment system. Pre-treatment technologies use physical removal mechanisms, such as screening, flotation, settling and filtration.

Behavioural and technical source control measures at the household or building level can reduce pollution loads and keep pre-treatment requirements low. For example, solid waste and cooking oil should be collected separately and not disposed of in sanitation systems. Equipping sinks, showers and the like with appropriate screens, filters and water seals can prevent solids from

entering the system. Sewer inspection chambers should always be closed with manhole covers to prevent extraneous material from entering the sewer.

Grease Trap The goal of the grease trap is to trap oil and grease so that it can be easily collected and removed. Grease traps are chambers made out of brickwork, concrete or plastic, with an odour-tight cover. Baffles or tees at the inlet and outlet prevent turbulence at the water surface and separate floating components from the effluent. A grease trap can either be located directly under the sink, or, for larger amounts of oil and grease, a bigger grease interceptor can be installed outdoors. An under-the-sink grease trap is relatively low cost, but must be cleaned frequently (once a week to once a month), whereas a larger grease interceptor has a higher capital cost, but is designed to be pumped out every 6 to 12 months. If designed to be large enough, grease traps can also remove grit and other settleable solids through sedimentation, similar to Septic Tanks (S.9).

Screen Screening aims to prevent coarse solids, such as plastics, rags and other trash, from entering a sewer

age system or treatment plant. Solids get trapped by inclined screens or bar racks. The spacing between the bars usually is 15 to 40 mm, depending on cleaning patterns. Screens can be cleaned by hand or mechanically raked. The latter allows for a more frequent solids removal and, correspondingly, a smaller design.

Grit Chamber Where subsequent treatment technologies could be hindered or damaged by the presence of sand, grit chambers (or sand traps) allow for the removal of heavy inorganic fractions by settling. There are three general types of grit chambers: horizontal-flow, aerated, or vortex chambers. All of these designs allow heavy grit particles to settle out, while lighter, principally organic particles remain in suspension.

Appropriateness Grease traps should be applied where considerable amounts of oil and grease are discharged. They can be installed at single households, restaurants or industrial sites. Grease removal is especially important where there is an immediate risk of clogging (e.g., a constructed wetland for the treatment of greywater).

Screening is essential where solid waste may enter a sewer system, as well as at the entrance of treatment plants. Trash traps, e.g., mesh boxes, can also be applied at strategic locations like market drains.

A grit chamber helps prevent sand deposits and abrasion in wastewater treatment plants, particularly, where roads are not paved and/or stormwater may enter the sewer system.

As laundries release high amounts of fabric fibres and particles with their wastewater, they should be equipped with lint trap devices.

Health Aspects/Acceptance The removal of solids and grease from pre-treatment technologies is not pleasant and, if households or community members are responsible for doing this, it may not be done regularly. Hiring professionals to do the removal may be the best option though it is costly. The people involved in the cleaning may come in contact with pathogens or toxic substances; therefore, adequately protecting oneself with safety clothes, i.e., boots and gloves, is essential.

Operation & Maintenance All pre-treatment facilities must be regularly monitored and cleaned to ensure proper functioning. If the maintenance frequency is too low, strong odours can result from the degradation of the accumulated material. Insufficiently maintained pre-treatment units can eventually lead to the failure of downstream elements of a sanitation system.

The pre-treatment products should be disposed of as solid waste in an environmentally sound way. In the case of grease, it may be used for energy production (e.g., biodiesel or co-digestion), or recycled for re-use.

Pros & Cons

- + Relatively low capital and operating costs
- + Reduced risk of impairing subsequent Conveyance and/or Treatment technologies
- + Higher lifetime and durability of sanitation hardware
- Frequent maintenance required
- The removal of solids and grease is not pleasant

References & Further Reading



- Crites, R. and Tchobanoglous, G. (1998). *Small and Decentralized Wastewater Management Systems*. WCB/McGraw-Hill, New York, US.
- Morel, A. and Diener, S. (2006). *Greywater Management in Low and Middle-Income Countries. Review of Different Treatment Systems for Households or Neighbourhoods*. Eawag (Department Sandec), Dübendorf, CH. Available at: www.sandec.ch
- Robbins, D. M. and Ligon, G.C. (2014). *How to Design Wastewater Systems for Local Conditions in Developing Countries*. IWA Publishing, London, UK.
- Tchobanoglous, G., Burton, F. L. and Stensel, H. D. (2004). *Wastewater Engineering: Treatment and Reuse*, Metcalf & Eddy, 4th Ed. (Internat. Ed.). McGraw-Hill, New York, US.
- Ulrich, A. (Ed.), Reuter, S. (Ed.), Gutterer, B. (Ed.), Sasse, L., Panzerbieter, T. and Reckerzügel, T. (2009). *Decentralised Wastewater Treatment Systems (DEWATS) and Sanitation in Developing Countries. A Practical Guide*. WEDC, Loughborough University, Leicestershire, UK.
- Wastewater Solutions for Development. <http://watsanexp.ning.com/page/pretreatment-and-grease> (last accessed February 2014)

Application Level:

- Household
 Neighbourhood
 City

Management Level:

- Household
 Shared
 Public

Inputs:  Blackwater  Brownwater
 Greywater

Outputs:  Effluent  Sludge

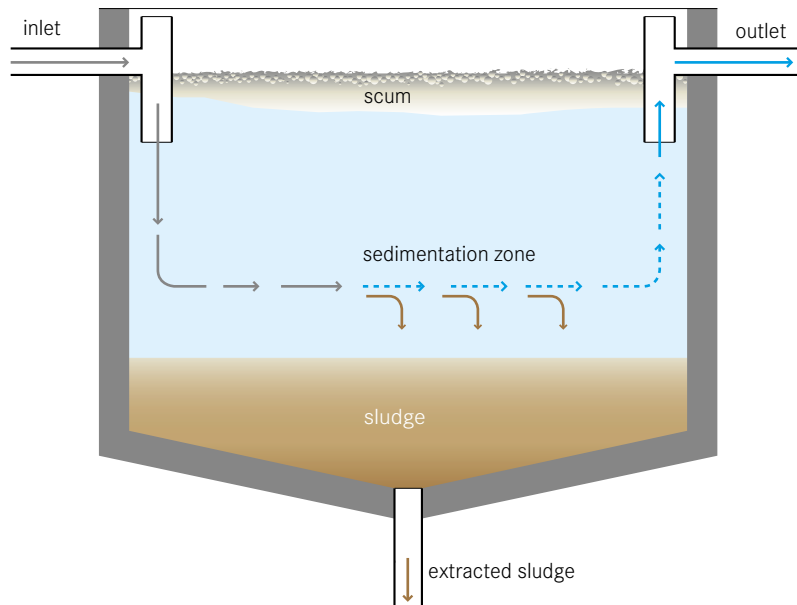

A settler is a primary treatment technology for wastewater; it is designed to remove suspended solids by sedimentation. It may also be referred to as a sedimentation or settling basin/tank, or clarifier. The low flow velocity in a settler allows settleable particles to sink to the bottom, while constituents lighter than water float to the surface.

Sedimentation is also used for the removal of grit (see PRE, p. 100), for secondary clarification in Activated Sludge treatment (see T.12), after chemical coagulation/precipitation, or for sludge thickening. This technology information sheet discusses the use of settlers as primary clarifiers, which are typically installed after a pre-treatment technology.

Settlers can achieve a significant initial reduction in suspended solids (50-70% removal) and organic material (20-40% BOD removal) and ensure that these constituents do not impair subsequent treatment processes.

Settlers may take a variety of forms, sometimes fulfilling additional functions. They can be independent tanks or integrated into combined treatment units. Several other technologies in this Compendium have a

primary sedimentation function or include a compartment for primary settling:

- the Septic Tank (S.9), where the low sludge removal frequency leads to anaerobic degradation of the sludge.
- the Anaerobic Baffled Reactor (S.10/T.3) and the Anaerobic Filter (S.11/T.4) both usually include a settler as the first compartment. However, the settler may also be built separately, e.g., in municipal treatment plants or in the case of prefabricated, modular units.
- the Biogas Reactor (S.12/T.17), which can be considered as a settler designed for anaerobic digestion and biogas production.
- the Imhoff Tank (T.2) and the Upflow Anaerobic Sludge Blanket Reactor (UASB, T.11), designed for the digestion of the settled sludge, prevent gases or sludge particles in the lower section from entering/returning to the upper section.
- the Waste Stabilization Ponds (WSP, T.5), of which the first anaerobic pond is for settling
- the Sedimentation/Thickening Ponds (T.13), which are designed for the solid-liquid separation of faecal sludge
- the Solids-Free Sewer (C.5), which includes interceptor tanks at the building level.

Design Considerations The main purpose of a settler is to facilitate sedimentation by reducing the velocity and turbulence of the wastewater stream. Settlers are circular or rectangular tanks that are typically designed for a hydraulic retention time of 1.5-2.5 h. Less time is needed if the BOD level should not be too low for the following biological step. The tank should be designed to ensure satisfactory performance at peak flow. In order to prevent eddy currents and short-circuiting, as well as to retain scum inside the basin, a good inlet and outlet construction with an efficient distribution and collection system (baffles, weirs or T-shaped pipes) is important.

Depending on the design, desludging can be done using a hand pump, airlift, vacuum pump, or by gravity using a bottom outlet. Large primary clarifiers are often equipped with mechanical collectors that continually scrape the settled solids towards a sludge hopper in the base of the tank, from where it is pumped to sludge treatment facilities. A sufficiently sloped tank bottom facilitates sludge removal. Scum removal can also be done either manually or by a collection mechanism.

The efficiency of the primary settler depends on factors like wastewater characteristics, retention time and sludge withdrawal rate. It may be reduced by wind-induced circulation, thermal convection and density currents due to temperature differentials, and, in hot climates, thermal stratification. These phenomena can lead to short-circuiting.

Several possibilities exist to enhance the performance of settlers. Examples include the installation of inclined plates (lamellae) and tubes, which increase the settling area, or the use of chemical coagulants.

Appropriateness The choice of a technology to settle the solids is governed by the size and type of the installation, the wastewater strength, the management capacities and the desirability of an anaerobic process, with or without biogas production.

Technologies that already include some type of primary sedimentation (listed above) do not need a separate settler. Many treatment technologies, however, require preliminary removal of solids in order to function properly.

Although the installation of a primary sedimentation tank is often omitted in small activated sludge plants, it is of particular importance for technologies that use a filter material. Settlers can also be installed as stormwater retention tanks to remove a portion of the organic solids that otherwise would be directly discharged into the environment.

Health Aspects/Acceptance To prevent the release of odorous gases, frequent sludge removal is necessary. Sludge and scum must be handled with care as they contain high levels of pathogenic organisms; they require further treatment and adequate disposal. Appropriate protective clothing is necessary for workers who may come in contact with the effluent, scum or sludge.

Operation & Maintenance In settlers that are not designed for anaerobic processes, regular sludge removal is necessary to prevent septic conditions and the build-up and release of gas which can hamper the sedimentation process by re-suspending part of the settled solids. Sludge transported to the surface by gas bubbles is difficult to remove and may pass to the next treatment stage.

Frequent scum removal and adequate treatment/disposal, either with the sludge or separately, is also important.

Pros & Cons

- + Simple and robust technology
- + Efficient removal of suspended solids
- + Relatively low capital and operating costs
- Frequent sludge removal
- Effluent, sludge and scum require further treatment
- Short-circuiting can be a problem

References & Further Reading

- EPA Ireland (1997). *Waste Water Treatment Manuals – Primary, Secondary and Tertiary Treatment*. Wexford, IE. Available at: www.epa.ie
- Tchobanoglous, G., Burton, F. L. and Stensel, H. D. (2004). *Wastewater Engineering: Treatment and Reuse*, Metcalf & Eddy, 4th Ed. (Internat. Ed.). McGraw-Hill, New York, US.

Application Level:

- Household
 Neighbourhood
 City

Management Level:

- Household
 Shared
 Public

Inputs: Blackwater Brownwater
 Greywater

Outputs: Effluent Sludge

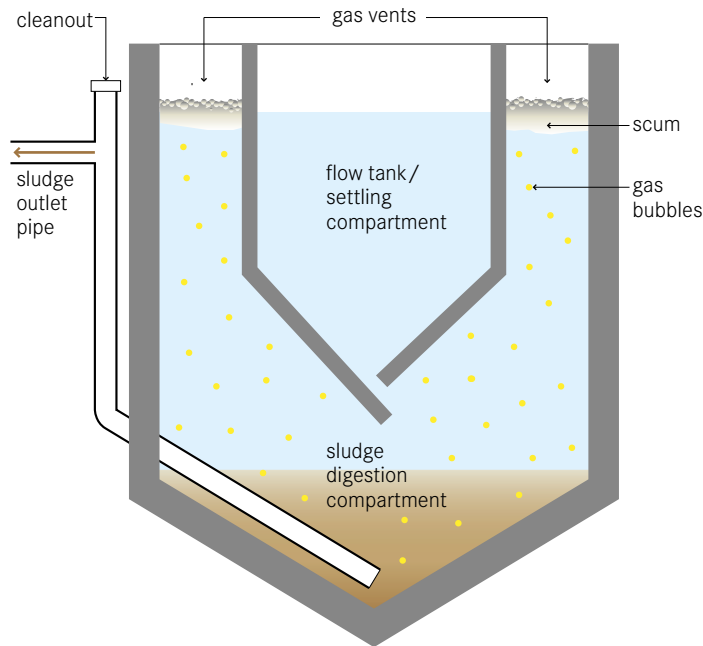

The Imhoff tank is a primary treatment technology for raw wastewater, designed for solid-liquid separation and digestion of the settled sludge. It consists of a V-shaped settling compartment above a tapering sludge digestion chamber with gas vents.

The Imhoff tank is a robust and effective settler that causes a suspended solids reduction of 50 to 70%, COD reduction of 25 to 50%, and leads to potentially good sludge stabilization – depending on the design and conditions. The settling compartment has a circular or rectangular shape with V-shaped walls and a slot at the bottom, allowing solids to settle into the digestion compartment, while preventing foul gas from rising up and disturbing the settling process. Gas produced in the digestion chamber rises into the gas vents at the edge of the reactor. It transports sludge particles to the water surface, creating a scum layer. The sludge accumulates in the sludge digestion compartment, and is compacted and partially stabilized through anaerobic digestion.

Design Considerations The Imhoff tank is usually built underground with reinforced concrete. It can, how-

ever, also be built above ground, which makes sludge removal easier due to gravity, although it still requires pumping up of the influent. Small prefabricated Imhoff tanks are also available on the market. Hydraulic retention time is usually not more than 2 to 4 hours to preserve an aerobic effluent for further treatment or discharge. T-shaped pipes or baffles are used at the inlet and the outlet to reduce velocity and prevent scum from leaving the system. The total water depth in the tank from the bottom to the water surface may reach 7 to 9.5 m. The bottom of the settling compartment is typically sloped 1.25 to 1.75 vertical to 1 horizontal and the slot opening can be 150 to 300 mm wide. The walls of the sludge digestion compartment should have an inclination of 45° or more. This allows the sludge to slide down to the centre where it can be removed. Dimensioning of the anaerobic digestion compartment depends mainly on sludge production per population equivalent, on the targeted degree of sludge stabilization (linked to the desludging frequency) and the temperature. The digestion chamber is usually designed for 4 to 12 months sludge storage capacity to allow for sufficient anaerobic digestion. In colder climates longer sludge retention time and, therefore, a greater volume

is needed. For desludging, a pipe and pump have to be installed or access provided for vacuum trucks and mobile pumps. A bar screen or grit chamber (see PRE, p. 100) is recommended before the Imhoff tank to prevent coarse material from disturbing the system.

Appropriateness Imhoff tanks are recommended for domestic or mixed wastewater flows between 50 and 20,000 population equivalents. They are able to treat high organic loads and are resistant against organic shock loads. Space requirements are low.

Imhoff tanks can be used in warm and cold climates. As the tank is very high, it can be built underground if the groundwater table is low and the location is not flood prone.

Health Aspects/Acceptance As the effluent is almost odourless, it is a good option for primary treatment if subsequent treatment takes place, e.g., in open ponds, constructed wetlands or trickling filters. Gases produced in low quantities may, however, generate odours locally. Pathogen removal is low and all outputs should be treated. Appropriate protective clothing is necessary for workers who may come in contact with the effluent, scum or sludge.

Operation & Maintenance Operation and maintenance are possible at low cost, if trained personnel are in charge. Flow paths have to be kept open and cleaned out weekly, while scum in the settling compartment and the gas vents has to be removed daily if necessary. Stabilized sludge from the bottom of the digestion compartment should be removed according to the design. A minimum clearance of 50 cm between the sludge blanket and the slot of the settling chamber has to be ensured at all times.

Pros & Cons

- + Solid-liquid separation and sludge stabilization are combined in one single unit
- + Resistant against organic shock loads
- + Small land area required
- + The effluent is not septic (with low odour)
- + Low operating costs

- Very high (or deep) infrastructure; depth may be a problem in case of high groundwater table
- Requires expert design and construction
- Low reduction of pathogens
- Effluent, sludge and scum require further treatment

References & Further Reading

- Alexandre, O., Boutin, C., Duchène, Ph., Lagrange, C., Lakel, A., Liénard, A. and Orditz, D. (1998). *Filières d'épuration adaptées aux petites collectivités*. Document technique FNDAE n°22, Cemagref, Lyon, FR. Available at: www.fndae.fr
- Herrera, A. (2006). *Rehabilitation of the Imhoff Tank Treatment Plant in Las Vegas, Santa Barbara Honduras, Central America*. Master thesis, Department of Civil, Architectural and Environmental Engineering, University of Texas, Austin, US. (Case study providing general information about Imhoff tanks and insights into implementation and operational problems. Recommendations for O&M are provided.)
- McLean, R. C. (2009). *Honduras Wastewater Treatment: Chemically Enhanced Primary Treatment and Sustainable Secondary Treatment Technologies for Use with Imhoff Tanks*. Master thesis, Department of Civil and Environmental Engineering, Massachusetts Institute of Technology, Cambridge, US. (Case study including a detailed description of the functionality of the Imhoff tank)
- Ulrich, A. (Ed.), Reuter, S. (Ed.), Gutterer, B. (Ed.), Sasse, L., Panzerbieter, T. and Reckerzügel, T. (2009). *Decentralised Wastewater Treatment Systems (DEWATS) and Sanitation in Developing Countries. A Practical Guide*. WEDC, Loughborough University, Leicestershire, UK. (Comprehensive handbook about planning and implementation of decentralized wastewater treatment options. It includes case studies and Excel spreadsheets for design calculations.)
- WSP (Ed.) (2008). *Philippines Sanitation Sourcebook and Decision Aid*. Water and Sanitation Program, Washington, D.C., US. Available at: documents.worldbank.org/curated/en/home (Basic information about low-cost decentralized sanitation technologies for decision makers. Presents fact sheets about 23 selected options, including the Imhoff tank.)

Application Level:

- ★ Household
- ★★ Neighbourhood
- City

Management Level:

- ★ Household
- ★★ Shared
- ★★ Public

Inputs: Effluent Blackwater
 Brownwater Greywater

Outputs: Effluent Sludge

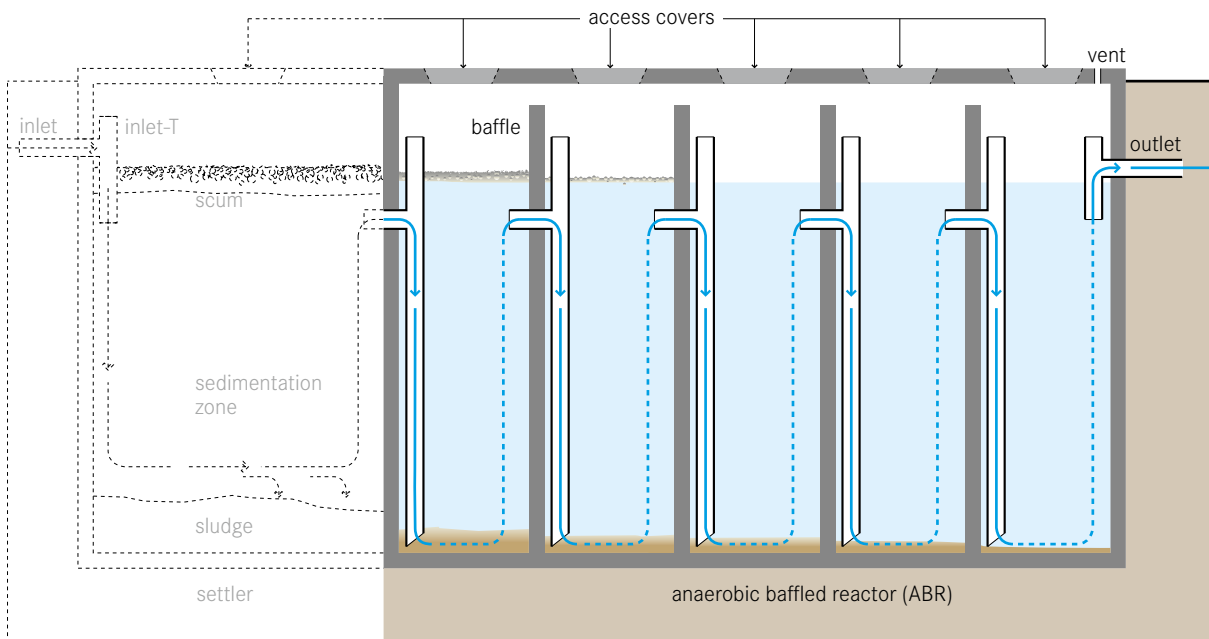

An anaerobic baffled reactor (ABR) is an improved Septic Tank (S.9) with a series of baffles under which the wastewater is forced to flow. The increased contact time with the active biomass (sludge) results in improved treatment.

The upflow chambers provide enhanced removal and digestion of organic matter. BOD may be reduced by up to 90%, which is far superior to its removal in a conventional Septic Tank.

Design Considerations The majority of settleable solids are removed in a sedimentation chamber in front of the actual ABR. Small-scale, stand-alone units typically have an integrated settling compartment (as shown in S.10), but primary sedimentation can also take place in a separate Settler (T.1) or another preceding technology (e.g., existing Septic Tanks). Designs without a settling compartment are of particular interest for (Semi-) Centralized Treatment plants that combine the ABR with another technology for primary settling, or where prefabricated, modular units are used.

Typical inflows range from 2 to 200 m³ per day. Critical design parameters include a hydraulic retention

time (HRT) between 48 to 72 hours, upflow velocity of the wastewater below 0.6 m/h and the number of upflow chambers (3 to 6). The connection between the chambers can be designed either with vertical pipes or baffles. Accessibility to all chambers (through access ports) is necessary for maintenance. Usually, the biogas produced in an ABR through anaerobic digestion is not collected because of its insufficient amount. The tank should be vented to allow for controlled release of odorous and potentially harmful gases.

Appropriateness This technology is easily adaptable and can be applied at the household level, in small neighbourhoods or even in bigger catchment areas. It is most appropriate where a relatively constant amount of blackwater and greywater is generated. A (semi-) centralized ABR is appropriate when there is a pre-existing Conveyance technology, such as a Simplified Sewer (C.4).

This technology is suitable for areas where land may be limited since the tank is most commonly installed underground and requires a small area. However, a vacuum truck should be able to access the location because the sludge must be regularly removed (particularly from the settler).

ABRs can be installed in every type of climate, although the efficiency is lower in colder climates. They are not efficient at removing nutrients and pathogens. The effluent usually requires further treatment.

Health Aspects/Acceptance Under normal operating conditions, users do not come in contact with the influent or effluent. Effluent, scum and sludge must be handled with care as they contain high levels of pathogenic organisms. The effluent contains odorous compounds that may have to be removed in a further polishing step. Care should be taken to design and locate the facility such that odours do not bother community members.

Operation & Maintenance An ABR requires a start-up period of several months to reach full treatment capacity since the slow growing anaerobic biomass first needs to be established in the reactor. To reduce start-up time, the ABR can be inoculated with anaerobic bacteria, e.g., by adding fresh cow dung or Septic Tank sludge. The added stock of active bacteria can then multiply and adapt to the incoming wastewater. Because of the delicate ecology, care should be taken not to discharge harsh chemicals into the ABR.

Scum and sludge levels need to be monitored to ensure that the tank is functioning well. Process operation in general is not required, and maintenance is limited to the removal of accumulated sludge and scum every 1 to 3 years. This is best done using a Motorized Emptying and Transport technology (C.3). The desludging frequency depends on the chosen pre-treatment steps, as well as on the design of the ABR.

ABR tanks should be checked from time to time to ensure that they are watertight.

Pros & Cons

- + Resistant to organic and hydraulic shock loads
- + No electrical energy is required
- + Low operating costs
- + Long service life
- + High reduction of BOD
- + Low sludge production; the sludge is stabilized
- + Moderate area requirement (can be built underground)

- Requires expert design and construction
- Low reduction of pathogens and nutrients
- Effluent and sludge require further treatment and/or appropriate discharge

References & Further Reading

- Bachmann, A., Beard, V. L. and McCarty, P. L. (1985). *Performance Characteristics of the Anaerobic Baffled Reactor*. Water Research 19 (1): 99-106.
- Barber, W. P. and Stuckey, D. C. (1999). *The Use of the Anaerobic Baffled Reactor (ABR) for Wastewater Treatment: A Review*. Water Research 33 (7): 1559-1578.
- Foxon, K. M., Buckley, C. A., Brouckaert, C. J., Dama, P., Mtembu, Z., Rodda, N., Smith, M., Pillay, S., Arjun, N., Lalbahadur, T. and Bux, F. (2006). *Evaluation of the Anaerobic Baffled Reactor for Sanitation in Dense Peri-urban Settlements*. WRC Report No 1248/01/06, Water Research Commission, Pretoria, ZA.
Available at: www.wrc.org.za
- Foxon, K. M., Pillay, S., Lalbahadur, T., Rodda, N., Holder, F. and Buckley, C. A. (2004). *The Anaerobic Baffled Reactor (ABR): An Appropriate Technology for on-Site Sanitation*. Water SA 30 (5) (Special Edition).
Available at: www.wrc.org.za
- Stuckey, D. C. (2010). *Anaerobic Baffled Reactor (ABR) for Wastewater Treatment*. In: Environmental Anaerobic Technology. Applications and New Developments, H. H. P. Fang (Ed.), Imperial College Press, London, UK.
- Ulrich, A. (Ed.), Reuter, S. (Ed.), Gutterer, B. (Ed.), Sasse, L., Panzerbieter, T. and Reckerzügel, T. (2009). *Decentralised Wastewater Treatment Systems (DEWATS) and Sanitation in Developing Countries. A Practical Guide*. WEDC, Loughborough University, Leicestershire, UK.

Application Level:

- ★ Household
- ★★ Neighbourhood
- City

Management Level:

- ★ Household
- ★★ Shared
- ★★ Public

Inputs: Effluent Blackwater
 Brownwater Greywater

Outputs: Effluent Sludge

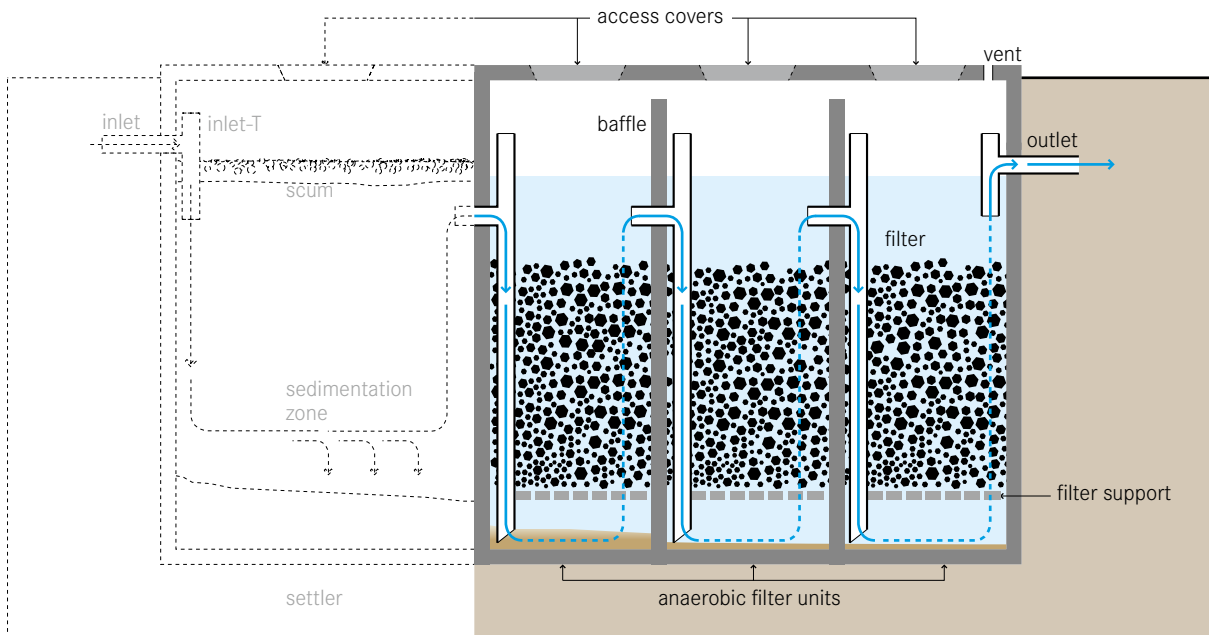

An anaerobic filter is a fixed-bed biological reactor with one or more filtration chambers in series. As wastewater flows through the filter, particles are trapped and organic matter is degraded by the active biomass that is attached to the surface of the filter material.

With this technology, suspended solids and BOD removal can be as high as 90%, but is typically between 50% and 80%. Nitrogen removal is limited and normally does not exceed 15% in terms of total nitrogen (TN).

Design Considerations Pre- and primary treatment is essential to remove solids and garbage that may clog the filter. The majority of settleable solids are removed in a sedimentation chamber in front of the anaerobic filter. Small-scale, stand-alone units typically have an integrated settling compartment (as shown in S.11), but primary sedimentation can also take place in a separate Settler (T.1) or another preceding technology (e.g., existing Septic Tanks). Designs without a settling compartment are of particular interest for (Semi-) Centralized Treatment plants that combine the anaerobic filter with other

technologies, such as the Anaerobic Baffled Reactor (ABR, T.3).

Anaerobic filters are usually operated in upflow mode because there is less risk that the fixed biomass will be washed out. The water level should cover the filter media by at least 0.3 m to guarantee an even flow regime. The hydraulic retention time (HRT) is the most important design parameter influencing filter performance. An HRT of 12 to 36 hours is recommended.

The ideal filter should have a large surface area for bacteria to grow, with pores large enough to prevent clogging. The surface area ensures increased contact between the organic matter and the attached biomass that effectively degrades it. Ideally, the material should provide between 90 to 300 m² of surface area per m³ of occupied reactor volume. Typical filter material sizes range from 12 to 55 mm in diameter. Materials commonly used include gravel, crushed rocks or bricks, cinder, pumice, or specially formed plastic pieces, depending on local availability. The connection between the chambers can be designed either with vertical pipes or baffles. Accessibility to all chambers (through access ports) is necessary for maintenance. The tank should be

vented to allow for controlled release of odorous and potentially harmful gases.

Appropriateness This technology is easily adaptable and can be applied at the household level, in small neighbourhoods or even in bigger catchment areas. It is most appropriate where a relatively constant amount of blackwater and greywater is generated. The anaerobic filter can be used for secondary treatment, to reduce the organic loading rate for a subsequent aerobic treatment step, or for polishing.

This technology is suitable for areas where land may be limited since the tank is most commonly installed underground and requires a small area. Accessibility by vacuum truck is important for desludging.

Anaerobic filters can be installed in every type of climate, although the efficiency is lower in colder climates. They are not efficient at removing nutrients and pathogens. Depending on the filter material, however, complete removal of worm eggs may be achieved. The effluent usually requires further treatment.

Health Aspects/Acceptance Under normal operating conditions, users do not come in contact with the influent or effluent. Effluent, scum and sludge must be handled with care as they contain high levels of pathogenic organisms. The effluent contains odorous compounds that may have to be removed in a further polishing step. Care should be taken to design and locate the facility such that odours do not bother community members.

Operation & Maintenance An anaerobic filter requires a start-up period of 6 to 9 months to reach full treatment capacity since the slow growing anaerobic biomass first needs to be established on the filter media. To reduce start-up time, the filter can be inoculated with anaerobic bacteria, e.g., by spraying Septic Tank sludge onto the filter material. The flow should be gradually increased over time. Because of the delicate ecology, care should be taken not to discharge harsh chemicals into the anaerobic filter.

Scum and sludge levels need to be monitored to ensure that the tank is functioning well. Over time, solids will

clog the pores of the filter. As well, the growing bacterial mass will become too thick, break off and eventually clog pores. When the efficiency decreases, the filter must be cleaned. This is done by running the system in reverse mode (backwashing) or by removing and cleaning the filter material.

Anaerobic filter tanks should be checked from time to time to ensure that they are watertight.

Pros & Cons

- + No electrical energy is required
- + Low operating costs
- + Long service life
- + High reduction of BOD and solids
- + Low sludge production; the sludge is stabilized
- + Moderate area requirement (can be built underground)
- Requires expert design and construction
- Low reduction of pathogens and nutrients
- Effluent and sludge require further treatment and/or appropriate discharge
- Risk of clogging, depending on pre- and primary treatment
- Removing and cleaning the clogged filter media is cumbersome

References & Further Reading

- Morel, A. and Diener, S. (2006). *Greywater Management in Low and Middle-Income Countries. Review of Different Treatment Systems for Households or Neighbourhoods*. Eawag (Department Sandec), Dübendorf, CH. Available at: www.sandec.ch (Short summary including case studies – p. 28)
- von Sperling, M. and de Lemos Chernicharo, C. A. (2005). *Biological Wastewater Treatment in Warm Climate Regions, Volume One*. IWA Publishing, London, UK. pp. 728-804. Available at: www.iwawaterwiki.org (Detailed design instructions)
- Ulrich, A. (Ed.), Reuter, S. (Ed.), Gutterer, B. (Ed.), Sasse, L., Panzerbieter, T. and Reckerzügel, T. (2009). *Decentralised Wastewater Treatment Systems (DEWATS) and Sanitation in Developing Countries. A Practical Guide*. WEDC, Loughborough University, Leicestershire, UK. (Design summary including Excel spreadsheets for design calculations)

Application Level:

- Household
- Neighbourhood
- City

Management Level:

- Household
- Shared
- Public

Inputs: Blackwater Brownwater
 Greywater Sludge

Outputs: Effluent Sludge

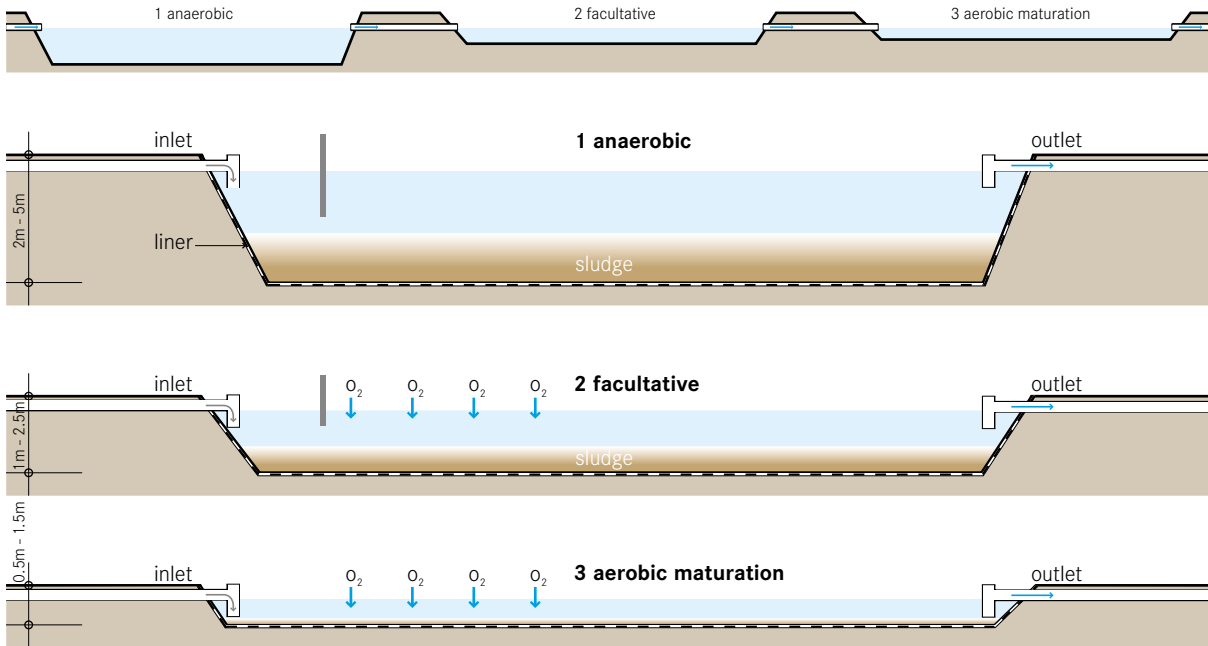

Waste Stabilization Ponds (WSPs) are large, man-made water bodies. The ponds can be used individually, or linked in a series for improved treatment. There are three types of ponds, (1) anaerobic, (2) facultative and (3) aerobic (maturation), each with different treatment and design characteristics.

For the most effective treatment, WSPs should be linked in a series of three or more with effluent flowing from the anaerobic pond to the facultative pond and, finally, to the aerobic pond. The anaerobic pond is the primary treatment stage and reduces the organic load in the wastewater. The entire depth of this fairly deep pond is anaerobic. Solids and BOD removal occurs by sedimentation and through subsequent anaerobic digestion inside the sludge. Anaerobic bacteria convert organic carbon into methane and, through this process, remove up to 60% of the BOD.

In a series of WSPs, the effluent from the anaerobic pond is transferred to the facultative pond, where further BOD is removed. The top layer of the pond receives oxygen from natural diffusion, wind mixing and algae-driven photosynthesis. The lower layer is deprived of oxygen and becomes anoxic or anaerobic. Settleable

solids accumulate and are digested on the bottom of the pond. The aerobic and anaerobic organisms work together to achieve BOD reductions of up to 75%. Anaerobic and facultative ponds are designed for BOD removal, while aerobic ponds are designed for pathogen removal. An aerobic pond is commonly referred to as a maturation, polishing, or finishing pond because it is usually the last step in a series of ponds and provides the final level of treatment. It is the shallowest of the ponds, ensuring that sunlight penetrates the full depth for photosynthesis to occur. Photosynthetic algae release oxygen into the water and at the same time consume carbon dioxide produced by the respiration of bacteria. Because photosynthesis is driven by sunlight, the dissolved oxygen levels are highest during the day and drop off at night. Dissolved oxygen is also provided by natural wind mixing.

Design Considerations Anaerobic ponds are built to a depth of 2 to 5 m and have a relatively short detention time of 1 to 7 days. Facultative ponds should be constructed to a depth of 1 to 2.5 m and have a detention time between 5 to 30 days. Aerobic ponds are usually between 0.5 to 1.5 m deep. If used in combination

with algae and/or fish harvesting (see D.9), this type of pond is effective at removing the majority of nitrogen and phosphorus from the effluent. Ideally, several aerobic ponds can be built in series to provide a high level of pathogen removal.

Pre-Treatment (see PRE, p. 100) is essential to prevent scum formation and to hinder excess solids and garbage from entering the ponds. To prevent leaching into the groundwater, the ponds should have a liner. The liner can be made from clay, asphalt, compacted earth, or any other impervious material. To protect the pond from runoff and erosion, a protective berm should be constructed around the pond using the excavated material. A fence should be installed to ensure that people and animals stay out of the area and that garbage does not enter the ponds.

Appropriateness WSPs are among the most common and efficient methods of wastewater treatment around the world. They are especially appropriate for rural and peri-urban communities that have large, unused land, at a distance from homes and public spaces. They are not appropriate for very dense or urban areas.

Health Aspects/Acceptance Although effluent from aerobic ponds is generally low in pathogens, the ponds should in no way be used for recreation or as a direct source of water for consumption or domestic use.

Operation & Maintenance Scum that builds up on the pond surface should be regularly removed. Aquatic plants (macrophytes) that are present in the pond should also be removed as they may provide a breeding habitat for mosquitoes and prevent light from penetrating the water column.

The anaerobic pond must be desludged approximately once every 2 to 5 years, when the accumulated solids reach one third of the pond volume. For facultative ponds sludge removal is even rarer and maturation ponds hardly ever need desludging. Sludge can be removed by using a raft-mounted sludge pump, a mechanical scraper at the bottom of the pond or by draining and dewatering the pond and removing the sludge with a front-end loader.

Pros & Cons

- + Resistant to organic and hydraulic shock loads
- + High reduction of solids, BOD and pathogens
- + High nutrient removal if combined with aquaculture
- + Low operating costs
- + No electrical energy is required
- + No real problems with insects or odours if designed and maintained correctly
- Requires a large land area
- High capital costs depending on the price of land
- Requires expert design and construction
- Sludge requires proper removal and treatment

References & Further Reading

- Kayombo, S., Mbwette, T. S. A., Katima, J. H. Y., Ladegaard, N. and Jorgensen, S. E. (2004). *Waste Stabilization Ponds and Constructed Wetlands Design Manual*. UNEP-IETC/Danida, Dar es Salaam, TZ/Copenhagen, DK. Available at: www.unep.org
- Peña Varón, M. and Mara, D. D. (2004). *Waste Stabilisation Ponds*. Thematic Overview Paper. IRC International Water and Sanitation Centre, Delft, NL. Available at: www.ircwash.org
- Shilton, A. (Ed.) (2005). *Pond Treatment Technology*. Integrated Environmental Technology Series, IWA Publishing, London, UK.
- von Sperling, M. (2007). *Waste Stabilisation Ponds*. Biological Wastewater Treatment Series, Volume Three. IWA Publishing, London, UK. Available at: www.iwawaterwiki.org
- von Sperling, M. and de Lemos Chernicharo, C. A. (2005). *Biological Wastewater Treatment in Warm Climate Regions, Volume One*. IWA Publishing, London, UK. pp. 495-656. Available at: www.iwawaterwiki.org
- Ulrich, A. (Ed.), Reuter, S. (Ed.), Gutterer, B. (Ed.), Sasse, L., Panzerbieter, T. and Reckerzügel, T. (2009). *Decentralised Wastewater Treatment Systems (DEWATS) and Sanitation in Developing Countries. A Practical Guide*. WEDC, Loughborough University, Leicestershire, UK. (Detailed description and Excel spreadsheets for design calculations)

Application Level:

- Household
 Neighbourhood
 City

Management Level:

- Household
 Shared
 Public

Inputs: Effluent Blackwater
 Brownwater Greywater

Outputs: Effluent Sludge

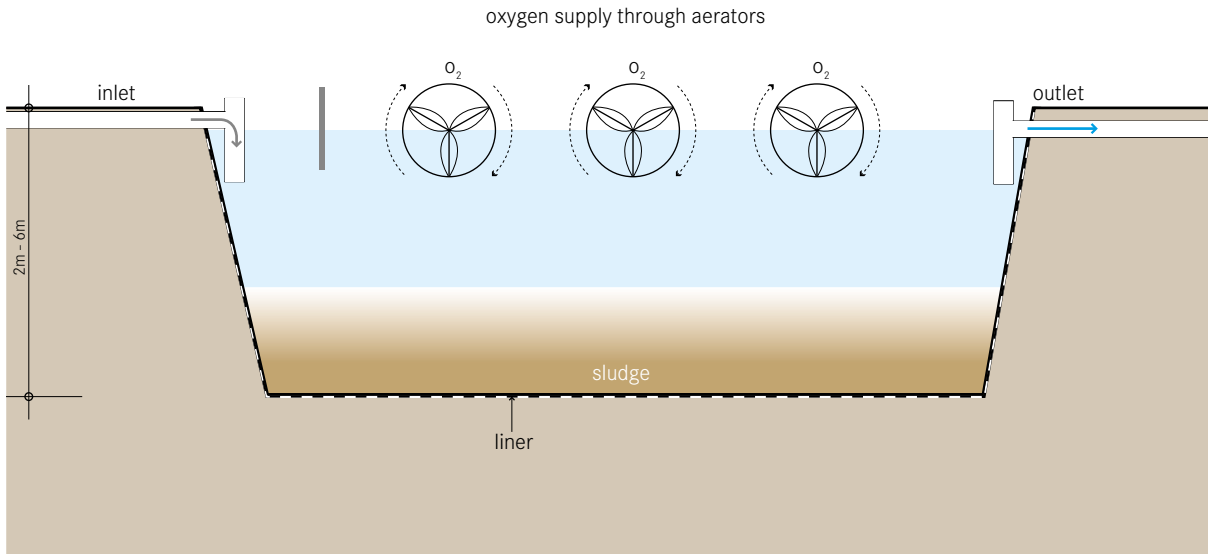

An aerated pond is a large, mixed, aerobic reactor. Mechanical aerators provide oxygen and keep the aerobic organisms suspended and mixed with water to achieve a high rate of organic degradation.

Increased mixing and aeration from the mechanical units means that the ponds can be deeper and tolerate much higher organic loads than a maturation pond. The increased aeration allows for increased degradation and increased pathogen removal. As well, because oxygen is introduced by the mechanical units and not by light-driven photosynthesis, the ponds can function in more northern climates.

Design Considerations Influent should be screened and pre-treated to remove garbage and coarse particles that could interfere with the aerators. Because the aeration units mix the pond, a subsequent settling tank is required to separate the effluent from the solids.

The pond should be built to a depth of 2 to 5 m and should have a detention time of 3 to 20 days, depending on the treatment target.

To prevent leaching, the pond should have a liner. This

can be made from clay, asphalt, compacted earth, or any other impervious material. A protective berm should be built around the pond, using the fill that is excavated, to protect it from runoff and erosion.

Appropriateness A mechanically aerated pond can efficiently handle concentrated influent and significantly reduce pathogen levels. It is especially important that electricity service is uninterrupted and that replacement parts are available to prevent extended downtimes that may cause the pond to turn anaerobic.

Aerated ponds can be used in both rural and peri-urban environments. They are most appropriate for regions with large areas of inexpensive land located away from homes and businesses. Aerated lagoons can function in a larger range of climates than Waste Stabilization Ponds (T.5) and the area requirement is smaller compared to a maturation pond.

Health Aspects/Acceptance The pond is a large expanse of pathogenic wastewater; care must be taken to ensure that no one comes in contact with or goes into the water.

The aeration units can be dangerous to humans and animals. Fences, signage, or other measures should be taken to prevent entry into the area.

Operation & Maintenance Permanent, skilled staff is required to maintain and repair aeration machinery and the pond must be desludged every 2 to 5 years. Care should be taken to ensure that the pond is not used as a garbage dump, especially considering the damage that could result to the aeration equipment.

Pros & Cons

- + Resistant to organic and hydraulic shock loads
- + High reduction of BOD and pathogens
- + No real problems with insects or odours if designed and maintained correctly
- Requires a large land area
- High energy consumption, a constant source of electricity is required
- High capital and operating costs depending on the price of land and of electricity
- Requires operation and maintenance by skilled personnel
- Not all parts and materials may be locally available
- Requires expert design and construction
- Sludge and possibly effluent require further treatment and/or appropriate discharge

References & Further Reading

- Arthur, J. P. (1983). *Notes on the Design and Operation of Waste Stabilization Ponds in Warm Climates of Developing Countries*. World Bank Technical Paper No. 7. The World Bank, Washington, D.C., US.
Available at: documents.worldbank.org/curated/en/home (Notes on applicability and effectiveness)
- Crites, R. and Tchobanoglous, G. (1998). *Small and Decentralized Wastewater Management Systems*. WCB/McGraw-Hill, New York, US. pp. 527-558.
(Comprehensive summary chapter)
- Tchobanoglous, G., Burton, F. L. and Stensel, H. D. (2004). *Wastewater Engineering: Treatment and Reuse*, Metcalf & Eddy, 4th Ed. (Internat. Ed.). McGraw-Hill, New York, US. pp. 840-854.
(Detailed design and example problems)

Application Level:

- ★ Household
- ★★ Neighbourhood
- ★★ City

Management Level:

- ★ Household
- ★★ Shared
- ★★ Public

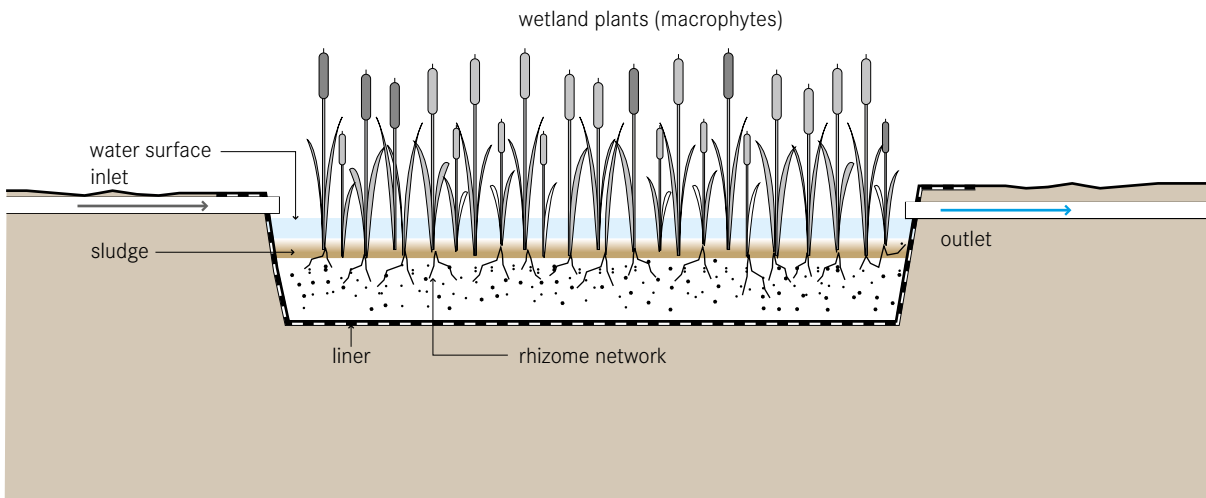
Inputs: Effluent Stormwater**Outputs:** Effluent Biomass

A free-water surface constructed wetland aims to replicate the naturally occurring processes of a natural wetland, marsh or swamp. As water slowly flows through the wetland, particles settle, pathogens are destroyed, and organisms and plants utilize the nutrients. This type of constructed wetland is commonly used as an advanced treatment after secondary or tertiary treatment processes.

Unlike the Horizontal Subsurface Flow Constructed Wetland (T.8), the free-water surface constructed wetland allows water to flow above ground exposed to the atmosphere and to direct sunlight. As the water slowly flows through the wetland, simultaneous physical, chemical and biological processes filter solids, degrade organics and remove nutrients from the wastewater.

Raw blackwater should be pre-treated to prevent the excess accumulation of solids and garbage. Once in the pond, the heavier sediment particles settle out, and this also removes the nutrients attached to them. Plants, and the communities of microorganisms that they support (on the stems and roots), take up nutrients like nitrogen and phosphorus. Chemical reactions may cause other elements to precipitate out of the wastewater.

Pathogens are removed from the water by natural decay, predation from higher organisms, sedimentation and UV irradiation.

Although the soil layer below the water is anaerobic, the plant roots exude (release) oxygen into the area immediately surrounding the root hairs, thus, creating an environment for complex biological and chemical activity.

Design Considerations The channel or basin is lined with an impermeable barrier (clay or geo-textile) covered with rocks, gravel and soil and planted with native vegetation (e.g., cattails, reeds and/or rushes). The wetland is flooded with wastewater to a depth of 10 to 45 cm above ground level. The wetland is compartmentalized into at least two independent flow paths. The number of compartments in series depends on the treatment target. The efficiency of the free-water surface constructed wetland also depends on how well the water is distributed at the inlet. Wastewater can be fed into the wetland, using weirs or by drilling holes in a distribution pipe, to allow it to enter at evenly spaced intervals.

Appropriateness Free-water surface constructed wetlands can achieve a high removal of suspended sol-

ids and moderate removal of pathogens, nutrients and other pollutants, such as heavy metals. This technology is able to tolerate variable water levels and nutrient loads. Plants limit the dissolved oxygen in the water from their shade and their buffering of the wind; therefore, this type of wetland is only appropriate for low-strength wastewater. This also makes it appropriate only when it follows some type of primary treatment to lower the BOD. Because of the potential for human exposure to pathogens, this technology is rarely used as secondary treatment. Typically, it is used for polishing effluent that has been through secondary treatment, or for stormwater retention and treatment.

The free-water surface wetland is a good option where land is cheap and available. Depending on the volume of the water and the corresponding area requirement of the wetland, it can be appropriate for small sections of urban areas, as well as for peri-urban and rural communities. This technology is best suited for warm climates, but can be designed to tolerate some freezing and periods of low biological activity.

Health Aspects/Acceptance The open surface can act as a potential breeding ground for mosquitoes. However, good design and maintenance can prevent this. Free-water surface constructed wetlands are generally aesthetically pleasing, especially when they are integrated into pre-existing natural areas. Care should be taken to prevent people from coming in contact with the effluent because of the potential for disease transmission and the risk of drowning in deep water.

Operation & Maintenance Regular maintenance should ensure that water is not short-circuiting, or backing up because of fallen branches, garbage, or beaver dams blocking the wetland outlet. Vegetation may have to be periodically cut back or thinned out.

Pros & Cons

- + Aesthetically pleasing and provides animal habitat
- + High reduction of BOD and solids; moderate pathogen removal
- + Can be built and repaired with locally available materials

- + No electrical energy is required
- + No real problems with odours if designed and maintained correctly
- + Low operating costs
- May facilitate mosquito breeding
- Requires a large land area
- Long start-up time to work at full capacity
- Requires expert design and construction

References & Further Reading

- Crites, R. and Tchobanoglous, G. (1998). *Small and Decentralized Wastewater Management Systems*. WCB/McGraw-Hill, New York, US. pp. 582-599. (Comprehensive summary chapter including solved problems)
- Kadlec, R. H., Knight, R. L., Vymazal, J., Brix, H., Cooper, P. and Haberl, R. (2000). *Constructed Wetlands for Pollution Control. Processes, Performance, Design and Operation*. Scientific and Technical Report No. 8. IWA Publishing, London, UK. Available at: www.iwawaterwiki.org
- Kadlec, R. H. and Wallace, S. D. (2009). *Treatment Wetlands*, 2nd Ed. CRC Press, Taylor & Francis Group, Boca Raton, US.
- Merz, S. L. (2000). *Guidelines for Using Free Water Surface Constructed Wetlands to Treat Municipal Sewage*. Queensland Department of Natural Resources, Brisbane, AU.
- Poh-Eng, L. and Polprasert, C. (1998). *Constructed Wetlands for Wastewater Treatment and Resource Recovery*. Environmental Sanitation Information Center, AIT, Bangkok, TH.
- Polprasert, C., Veenstra, S. and van der Steen, P. (2001). *Wastewater Treatment II. Natural Systems for Wastewater Management, Chapter 6*. UNESCO-IHE, Delft, NL.
- U.S. EPA (2000). *Constructed Wetlands Treatment of Municipal Wastewaters*. EPA/625/R-99/010. U.S. Environmental Protection Agency, Washington, D.C., US. Available at: www.epa.gov
- Vymazal, J. (2008). *Constructed Wetlands for Wastewater Treatment: A Review*. In: Proceedings of Taal 2007: The 12th World Lake Conference, M. Sengupta and R. Dalwani (Eds.). pp. 965-980. Available at: www.moef.nic.in

Application Level:

- ★ Household
- ★★ Neighbourhood
- ★ City

Management Level:

- ★ Household
- ★★ Shared
- ★★ Public

Inputs: Effluent Blackwater
Brownwater Greywater

Outputs: Effluent Biomass

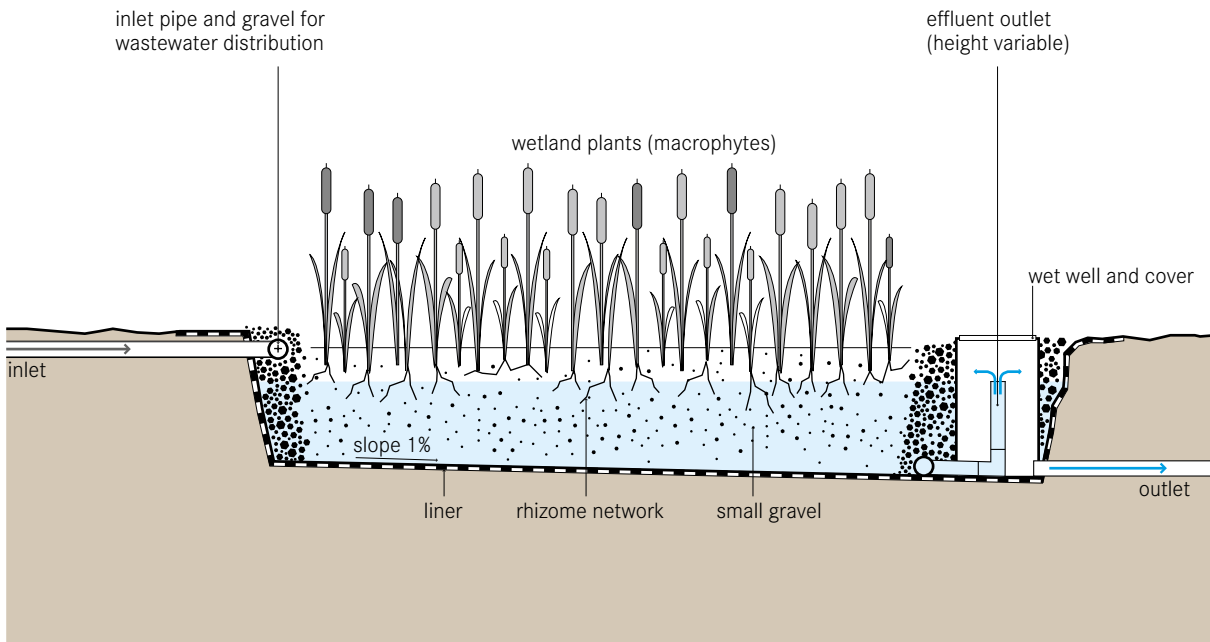

A horizontal subsurface flow constructed wetland is a large gravel and sand-filled basin that is planted with wetland vegetation. As wastewater flows horizontally through the basin, the filter material filters out particles and microorganisms degrade the organics.

The filter media acts as a filter for removing solids, a fixed surface upon which bacteria can attach, and a base for the vegetation. Although facultative and anaerobic bacteria degrade most organics, the vegetation transfers a small amount of oxygen to the root zone so that aerobic bacteria can colonize the area and degrade organics as well. The plant roots play an important role in maintaining the permeability of the filter.

Design Considerations The design of a horizontal subsurface flow constructed wetland depends on the treatment target and the amount and quality of the influent. It includes decisions about the amount of parallel flow paths and compartmentation. The removal efficiency of the wetland is a function of the surface area (length multiplied by width), while the cross-sectional area (width multiplied by depth) determines the

maximum possible flow. Generally, a surface area of about 5 to 10 m² per person equivalent is required.

Pre- and primary treatment is essential to prevent clogging and ensure efficient treatment. The influent can be aerated by an inlet cascade to support oxygen-dependent processes, such as BOD reduction and nitrification. The bed should be lined with an impermeable liner (clay or geotextile) to prevent leaching. It should be wide and shallow so that the flow path of the water in contact with vegetation roots is maximized. A wide inlet zone should be used to evenly distribute the flow. A well-designed inlet that allows for even distribution is important to prevent short-circuiting. The outlet should be variable so that the water surface can be adjusted to optimize treatment performance.

Small, round, evenly sized gravel (3 to 32 mm in diameter) is most commonly used to fill the bed to a depth of 0.5 to 1 m. To limit clogging, the gravel should be clean and free of fines. Sand is also acceptable, but is more prone to clogging than gravel. In recent years, alternative filter materials, such as PET, have been successfully used. The water level in the wetland is maintained at 5 to 15 cm below the surface to ensure subsurface flow. Any native plant with deep, wide roots that can grow

in the wet, nutrient-rich environment is appropriate. *Phragmites australis* (reed) is a common choice because it forms horizontal rhizomes that penetrate the entire filter depth.

Appropriateness Clogging is a common problem and, therefore, the influent should be well settled with primary treatment before flowing into the wetland. This technology is not appropriate for untreated domestic wastewater (i.e. blackwater). It is a good treatment for communities that have primary treatment (e.g., Septic Tanks, S.9), but are looking to achieve a higher quality effluent.

The horizontal subsurface flow constructed wetland is a good option where land is cheap and available. Depending on the volume of the water and the corresponding area requirement of the wetland, it can be appropriate for small sections of urban areas, as well as for peri-urban and rural communities. It can also be designed for single households.

This technology is best suited for warm climates, but it can be designed to tolerate some freezing and periods of low biological activity. If the effluent is to be reused, the losses due to high evapotranspiration rates could be a drawback of this technology, depending on the climate.

Health Aspects/Acceptance Significant pathogen removal is accomplished by natural decay, predation by higher organisms, and filtration. As the water flows below the surface, any contact of pathogenic organisms with humans and wildlife is minimized. The risk of mosquito breeding is reduced since there is no standing water compared to the risk associated with Free-Water Surface Constructed Wetlands (T.7). The wetland is aesthetically pleasing and can be integrated into wild areas or parklands.

Operation & Maintenance During the first growing season, it is important to remove weeds that can compete with the planted wetland vegetation. With time, the gravel will become clogged with accumulated solids and bacterial film. The filter material at the inlet zone will require replacement every 10 or more years. Maintenance

activities should focus on ensuring that primary treatment is effective at reducing the concentration of solids in the wastewater before it enters the wetland. Maintenance should also ensure that trees do not grow in the area as the roots can harm the liner.

Pros & Cons

- + High reduction of BOD, suspended solids and pathogens
- + Does not have the mosquito problems of the Free-Water Surface Constructed Wetland
- + No electrical energy is required
- + Low operating costs
- Requires a large land area
- Little nutrient removal
- Risk of clogging, depending on pre- and primary treatment
- Long start-up time to work at full capacity
- Requires expert design and construction

References & Further Reading

- Crites, R. and Tchobanoglous, G. (1998). *Small and Decentralized Wastewater Management Systems*. WCB/McGraw-Hill, New York, US. pp. 599-609.
(Comprehensive summary chapter including solved problems)
- Hoffmann, H., Platzer, C., Winker, M. and von Münch, E. (2011). *Technology Review of Constructed Wetlands. Subsurface Flow Constructed Wetlands for Greywater and Domestic Wastewater Treatment*. Gesellschaft für Internationale Zusammenarbeit (GIZ) GmbH, Eschborn, DE.
Available at: www.susana.org/library
- Kadlec, R. H. and Wallace, S. D. (2009). *Treatment Wetlands*, 2nd Ed. CRC Press, Taylor & Francis Group, Boca Raton, US.
- UN-HABITAT (2008). *Constructed Wetlands Manual*. UN-HABITAT Water for Asian Cities Programme. Kathmandu, NP.
Available at: www.unhabitat.org
- U.S. EPA (2000). *Constructed Wetlands Treatment of Municipal Wastewaters*. EPA/625/R-99/010. U.S. Environmental Protection Agency, Washington, D.C., US.
Available at: www.epa.gov

Application Level:

- ★ Household
- ★★ Neighbourhood
- ★★ City

Management Level:

- ★ Household
- ★ Shared
- ★★ Public

Inputs: Effluent Blackwater
 Brownwater Greywater

Outputs: Effluent Biomass

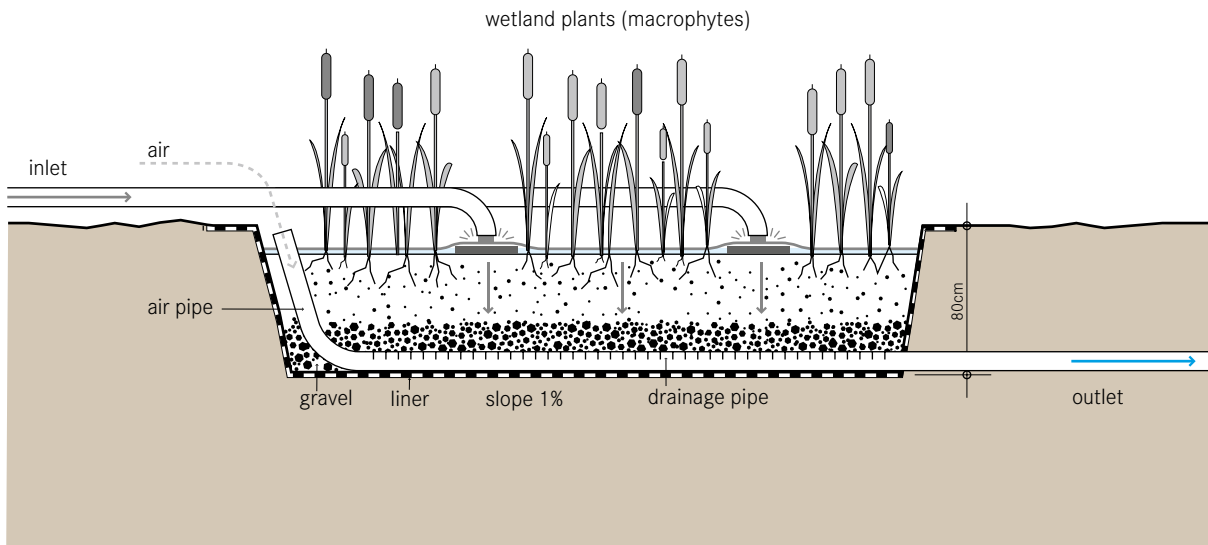

A vertical flow constructed wetland is a planted filter bed that is drained at the bottom. Wastewater is poured or dosed onto the surface from above using a mechanical dosing system. The water flows vertically down through the filter matrix to the bottom of the basin where it is collected in a drainage pipe. The important difference between a vertical and horizontal wetland is not simply the direction of the flow path, but rather the aerobic conditions.

By intermittently dosing the wetland (4 to 10 times a day), the filter goes through stages of being saturated and unsaturated, and, accordingly, different phases of aerobic and anaerobic conditions. During a flush phase, the wastewater percolates down through the unsaturated bed. As the bed drains, air is drawn into it and the oxygen has time to diffuse through the porous media. The filter media acts as a filter for removing solids, a fixed surface upon which bacteria can attach and a base for the vegetation. The top layer is planted and the vegetation is allowed to develop deep, wide roots, which permeate the filter media. The vegetation transfers a small amount of oxygen to the root zone so that aerobic bacteria can colonize the area and degrade

organics. However, the primary role of vegetation is to maintain permeability in the filter and provide habitat for microorganisms. Nutrients and organic material are absorbed and degraded by the dense microbial populations. By forcing the organisms into a starvation phase between dosing phases, excessive biomass growth can be decreased and porosity increased.

Design Considerations The vertical flow constructed wetland can be designed as a shallow excavation or as an above ground construction. Clogging is a common problem. Therefore, the influent should be well settled in a primary treatment stage before flowing into the wetland. The design and size of the wetland is dependent on hydraulic and organic loads. Generally, a surface area of about 1 to 3 m² per person equivalent is required. Each filter should have an impermeable liner and an effluent collection system. A ventilation pipe connected to the drainage system can contribute to aerobic conditions in the filter. Structurally, there is a layer of gravel for drainage (a minimum of 20 cm), followed by layers of sand and gravel. Depending on the climate, *Phragmites australis* (reed), *Typha* sp. (cattails) or *Echinochloa pyramidalis* are common plant options. Testing

may be required to determine the suitability of locally available plants with the specific wastewater.

Due to good oxygen transfer, vertical flow wetlands have the ability to nitrify, but denitrification is limited. In order to create a nitrification-denitrification treatment train, this technology can be combined with a Free-Water Surface or Horizontal Flow Wetland (T.7 and T.8).

Appropriateness The vertical flow constructed wetland is a good treatment for communities that have primary treatment (e.g., Septic Tanks, S.9), but are looking to achieve a higher quality effluent. Because of the mechanical dosing system, this technology is most appropriate where trained maintenance staff, constant power supply, and spare parts are available. Since vertical flow constructed wetlands are able to nitrify, they can be an appropriate technology in the treatment process for wastewater with high ammonium concentrations. Vertical flow constructed wetlands are best suited to warm climates, but can be designed to tolerate some freezing and periods of low biological activity.

Health Aspects/Acceptance Pathogen removal is accomplished by natural decay, predation by higher organisms, and filtration. The risk of mosquito breeding is low since there is no standing water. The system is generally aesthetic and can be integrated into wild areas or parklands. Care should be taken to ensure that people do not come in contact with the influent because of the risk of infection.

Operation & Maintenance During the first growing season, it is important to remove weeds that can compete with the planted wetland vegetation. Distribution pipes should be cleaned once a year to remove sludge and biofilm that might block the holes. With time, the gravel will become clogged by accumulated solids and bacterial film. Resting intervals may restore the hydraulic conductivity of the bed. If this does not help, the accumulated material has to be removed and clogged parts of the filter material replaced. Maintenance activities should focus on ensuring that primary treatment is effective at reducing the concentration of solids in the wastewater before it enters the wetland. Maintenance

should also ensure that trees do not grow in the area as the roots can harm the liner.

Pros & Cons

- + High reduction of BOD, suspended solids and pathogens
- + Ability to nitrify due to good oxygen transfer
- + Does not have the mosquito problems of the Free-Water Surface Constructed Wetland
- + Less clogging than in a Horizontal Subsurface Flow Constructed Wetland
- + Requires less space than a Free-Water Surface or Horizontal Flow Wetland
- + Low operating costs
- Requires expert design and construction, particularly, the dosing system
- Requires more frequent maintenance than a Horizontal Subsurface Flow Constructed Wetland
- A constant source of electrical energy may be required
- Long start-up time to work at full capacity
- Not all parts and materials may be locally available

References & Further Reading

- Brix, H. and Arias, C. A. (2005). *The Use of Vertical Flow Constructed Wetlands for on-Site Treatment of Domestic Wastewater: New Danish Guidelines*. Ecological Engineering 25 (5): 491-500.
- Crites, R. and Tchobanoglous, G. (1998). *Small and Decentralized Wastewater Management Systems*. WCB/McGraw-Hill, New York, US. pp. 599-609. (Comprehensive summary chapter including solved problems)
- Kadlec, R. H. and Wallace, S. D. (2009). *Treatment Wetlands*, 2nd Ed. CRC Press, Taylor & Francis Group, Boca Raton, US.
- UN-HABITAT (2008). *Constructed Wetlands Manual*. UN-HABITAT Water for Asian Cities Programme. Kathmandu, NP. Available at: www.unhabitat.org
- U.S. EPA (2000). *Constructed Wetlands Treatment of Municipal Wastewaters*. EPA/625/R-99/010. U.S. Environmental Protection Agency, Washington, D.C., US. Available at: www.epa.gov

Application Level:

- Household
 Neighbourhood
 City

Management Level:

- Household
 Shared
 Public

Inputs: Effluent Blackwater
 Brownwater Greywater

Outputs: Effluent Sludge

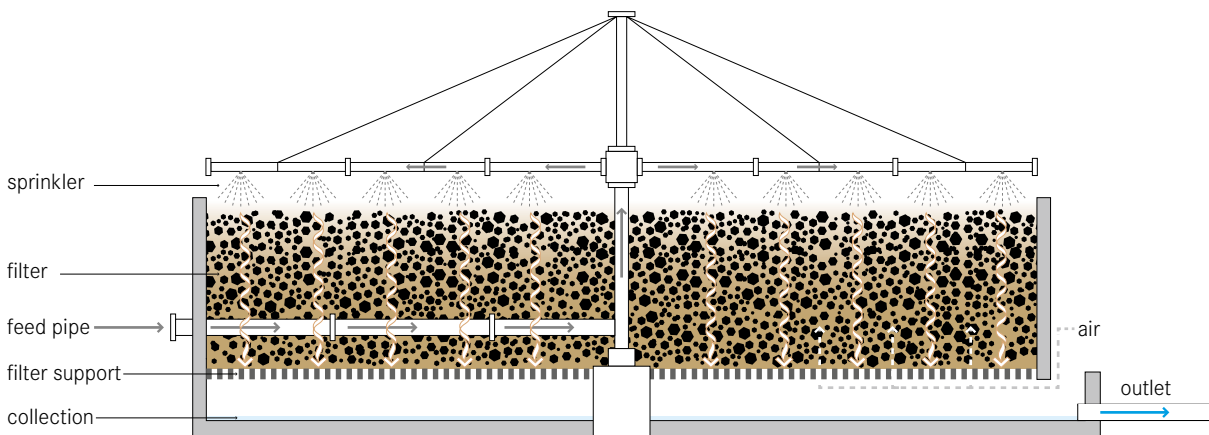

A trickling filter is a fixed-bed, biological reactor that operates under (mostly) aerobic conditions. Pre-settled wastewater is continuously ‘trickled’ or sprayed over the filter. As the water migrates through the pores of the filter, organics are degraded by the biofilm covering the filter material.

The trickling filter is filled with a high specific surface area material, such as rocks, gravel, shredded PVC bottles, or special pre-formed plastic filter media. A high specific surface provides a large area for biofilm formation. Organisms that grow in the thin biofilm over the surface of the media oxidize the organic load in the wastewater to carbon dioxide and water, while generating new biomass.

The incoming pre-treated wastewater is ‘trickled’ over the filter, e.g., with the use of a rotating sprinkler. In this way, the filter media goes through cycles of being dosed and exposed to air. However, oxygen is depleted within the biomass and the inner layers may be anoxic or anaerobic.

Design Considerations The filter is usually 1 to 2.5 m deep, but filters packed with lighter plastic filling

can be up to 12 m deep. The ideal filter material is low-cost and durable, has a high surface to volume ratio, is light, and allows air to circulate. Whenever it is available, crushed rock or gravel is the cheapest option. The particles should be uniform and 95% of them should have a diameter between 7 and 10 cm. A material with a specific surface area between 45 and 60 m²/m³ for rocks and 90 to 150 m²/m³ for plastic packing is normally used. Larger pores (as in plastic packing) are less prone to clogging and provide for good air circulation. Primary treatment is also essential to prevent clogging and to ensure efficient treatment.

Adequate air flow is important to ensure sufficient treatment performance and prevent odours. The underdrains should provide a passageway for air at the maximum filling rate. A perforated slab supports the bottom of the filter, allowing the effluent and excess sludge to be collected. The trickling filter is usually designed with a recirculation pattern for the effluent to improve wetting and flushing of the filter material.

With time, the biomass will grow thick and the attached layer will be deprived of oxygen; it will enter an endogenous state, will lose its ability to stay attached and will slough off. High-rate loading conditions will also cause

sloughing. The collected effluent should be clarified in a settling tank to remove any biomass that may have dislodged from the filter. The hydraulic and nutrient loading rate (i.e., how much wastewater can be applied to the filter) is determined based on the characteristics of the wastewater, the type of filter media, the ambient temperature, and the discharge requirements.

Appropriateness This technology can only be used following primary clarification since high solids loading will cause the filter to clog. A low-energy (gravity) trickling system can be designed, but in general, a continuous supply of power and wastewater is required.

Compared to other technologies (e.g., Waste Stabilization Ponds, T.5), trickling filters are compact, although they are still best suited for peri-urban or large, rural settlements.

Trickling filters can be built in almost all environments, but special adaptations for cold climates are required.

Health Aspects/Acceptance Odour and fly problems require that the filter be built away from homes and businesses. Appropriate measures must be taken for pre- and primary treatment, effluent discharge and solids treatment, all of which can still pose health risks.

Operation & Maintenance A skilled operator is required to monitor the filter and repair the pump in case of problems. The sludge that accumulates on the filter must be periodically washed away to prevent clogging and keep the biofilm thin and aerobic. High hydraulic loading rates (flushing doses) can be used to flush the filter. Optimum dosing rates and flushing frequency should be determined from the field operation.

The packing must be kept moist. This may be problematic at night when the water flow is reduced or when there are power failures.







Snails grazing on the biofilm and filter flies are well known problems associated with trickling filters and must be handled by backwashing and periodic flooding.

Pros & Cons

- + Can be operated at a range of organic and hydraulic loading rates
- + Efficient nitrification (ammonium oxidation)
- + Small land area required compared to constructed wetlands
- High capital costs
- Requires expert design and construction, particularly, the dosing system
- Requires operation and maintenance by skilled personnel
- Requires a constant source of electricity and constant wastewater flow
- Flies and odours are often problematic
- Risk of clogging, depending on pre- and primary treatment
- Not all parts and materials may be locally available

References & Further Reading

- Tchobanoglous, G., Burton, F. L. and Stensel, H. D. (2004). *Wastewater Engineering: Treatment and Reuse*, Metcalf & Eddy, 4th Ed. (Internat. Ed.). McGraw-Hill, New York, US. pp. 890-930.
(Detailed description and example calculations)
- Ulrich, A. (Ed.), Reuter, S. (Ed.), Gutterer, B. (Ed.), Sasse, L., Panzerbieter, T. and Reckerzügel, T. (2009). *Decentralised Wastewater Treatment Systems (DEWATS) and Sanitation in Developing Countries. A Practical Guide*. WEDC, Loughborough University, Leicestershire, UK.
- U.S. EPA (2000). *Wastewater Technology Fact Sheet. Trickling Filters*. 832-F-00-014. U.S. Environmental Protection Agency, Washington, D.C., US.
Available at: www.epa.gov
(Design summary including tips for trouble shooting)

Application Level:	Management Level:	Inputs:  Blackwater  Brownwater
		(+  Greywater)
<input type="checkbox"/> Household	<input type="checkbox"/> Household	Outputs:  Effluent  Sludge  Biogas
<input checked="" type="checkbox"/> Neighbourhood	<input type="checkbox"/> Shared	
<input checked="" type="checkbox"/> City	<input checked="" type="checkbox"/> Public	

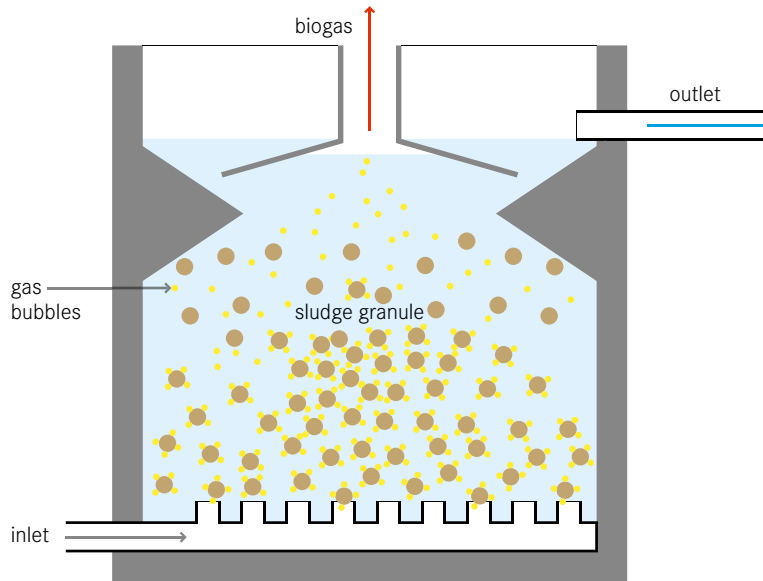

The upflow anaerobic sludge blanket reactor (UASB) is a single tank process. Wastewater enters the reactor from the bottom, and flows upward. A suspended sludge blanket filters and treats the wastewater as the wastewater flows through it.

The sludge blanket is comprised of microbial granules (1 to 3 mm in diameter), i.e., small agglomerations of microorganisms that, because of their weight, resist being washed out in the upflow. The microorganisms in the sludge layer degrade organic compounds. As a result, gases (methane and carbon dioxide) are released. The rising bubbles mix the sludge without the assistance of any mechanical parts. Sloped walls deflect material that reaches the top of the tank downwards. The clarified effluent is extracted from the top of the tank in an area above the sloped walls.

After several weeks of use, larger granules of sludge form which, in turn, act as filters for smaller particles as the effluent rises through the cushion of sludge. Because of the upflow regime, granule-forming organisms are preferentially accumulated as the others are washed out.

Design Considerations Critical elements for the design of UASB reactors are the influent distribution system, the gas-solids separator, and the effluent withdrawal design. The gas that rises to the top is collected in a gas collection dome and can be used as energy (biogas). An upflow velocity of 0.7 to 1 m/h must be maintained to keep the sludge blanket in suspension. Primary settling is usually not required before the UASB.

Appropriateness A UASB is not appropriate for small or rural communities without a constant water supply or electricity. The technology is relatively simple to design and build, but developing the granulated sludge may take several months. The UASB reactor has the potential to produce higher quality effluent than Septic Tanks (S.9), and can do so in a smaller reactor volume. Although it is a well-established process for large-scale industrial wastewater treatment and high organic loading rates up to 10 kg BOD/m³/d, its application to domestic sewage is still relatively new. It is often used for brewery, distillery, food processing and pulp and paper waste since the process typically removes 80 to 90% of COD. Where the influent is low-strength or where it contains too many solids, proteins

or fats, the reactor may not work properly. Temperature is also a key factor affecting the performance.

Health Aspects/Acceptance The operators should take proper health and safety measures while working in the plant, such as adequate protective clothing. Effluent and sludge still pose a health risk and should not be directly handled.

Operation & Maintenance The UASB is a Centralized Treatment technology that must be operated and maintained by professionals. A skilled operator is required to monitor the reactor and repair parts, e.g., pumps, in case of problems. Desludging is infrequent and only excess sludge is removed every 2 to 3 years.

Pros & Cons

- + High reduction of BOD
- + Can withstand high organic and hydraulic loading rates
- + Low sludge production (and, thus, infrequent desludging required)
- + Biogas can be used for energy (but usually first requires scrubbing)
- Treatment may be unstable with variable hydraulic and organic loads
- Requires operation and maintenance by skilled personnel; difficult to maintain proper hydraulic conditions (upflow and settling rates must be balanced)
- Long start-up time
- A constant source of electricity is required
- Not all parts and materials may be locally available
- Requires expert design and construction
- Effluent and sludge require further treatment and/or appropriate discharge

References & Further Reading

- _ Lettinga, G., Roersma, R. and Grin, P. (1983). *Anaerobic Treatment of Raw Domestic Sewage at Ambient Temperatures Using a Granular Bed UASB Reactor*. *Biotechnology and Bioengineering* 25 (7): 1701-1723.
(The first paper describing the process)
- _ von Sperling, M. and de Lemos Chernicharo, C. A. (2005). *Biological Wastewater Treatment in Warm Climate Regions, Volume One*. IWA Publishing, London, UK. pp. 741-804.
Available at: www.iwawaterwiki.org
(Detailed design information)
- _ Tare, V. and Nema, A. (n.d.). *UASB Technology – Expectations and Reality*. United Nations Asian and Pacific Centre for Agricultural Engineering and Machinery, Beijing, CN.
Available at: www.unapcaem.org
(Assessment of UASB installations in India)
- _ Tchobanoglous, G., Burton, F. L. and Stensel, H. D. (2004). *Wastewater Engineering: Treatment and Reuse*, Metcalf & Eddy, 4th Ed. (Internat. Ed.). McGraw-Hill, New York, US. pp. 1005-1016.
(Detailed description and design information)
- _ Ulrich, A. (Ed.), Reuter, S. (Ed.), Gutterer, B. (Ed.), Sasse, L., Panzerbieter, T. and Reckerzügel, T. (2009). *Decentralised Wastewater Treatment Systems (DEWATS) and Sanitation in Developing Countries. A Practical Guide*. WEDC, Loughborough University, Leicestershire, UK.
(Short overview)
- _ Vigneswaran, S., Balasuriya, B. L. N. and Viraraghavan, T. (1986). *Environmental Sanitation Reviews. Anaerobic Wastewater Treatment – Attached Growth and Sludge Blanket Process*. Environmental Sanitation Information Center, AIT, Bangkok, TH.
(Good technical overview – Chapter 5)

Application Level:

- Household
 Neighbourhood
 City

Management Level:

- Household
 Shared
 Public

Inputs: Effluent Blackwater
 Brownwater Greywater

Outputs: Effluent Sludge

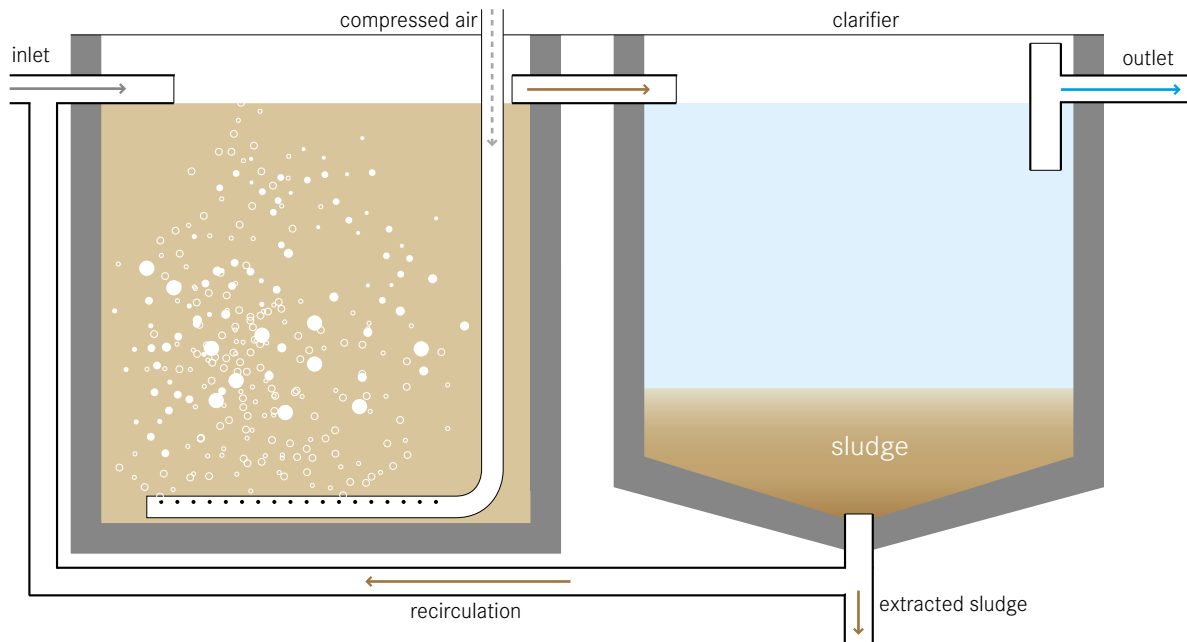

An activated sludge process refers to a multi-chamber reactor unit that makes use of highly concentrated microorganisms to degrade organics and remove nutrients from wastewater to produce a high-quality effluent. To maintain aerobic conditions and to keep the activated sludge suspended, a continuous and well-timed supply of oxygen is required.

Different configurations of the activated sludge process can be employed to ensure that the wastewater is mixed and aerated in an aeration tank. Aeration and mixing can be provided by pumping air or oxygen into the tank or by using surface aerators. The microorganisms oxidize the organic carbon in the wastewater to produce new cells, carbon dioxide and water. Although aerobic bacteria are the most common organisms, facultative bacteria along with higher organisms can be present. The exact composition depends on the reactor design, environment, and wastewater characteristics.

The flocs (agglomerations of sludge particles), which form in the aerated tank, can be removed in the secondary clarifier by gravity settling. Some of this sludge is recycled from the clarifier back to the reactor. The

effluent can be discharged or treated in a tertiary treatment facility if necessary for further use.

Design Considerations Activated sludge processes are one part of a complex treatment system. They are usually used after primary treatment (that removes settleable solids) and are sometimes followed by a final polishing step (see POST, p.136). The biological processes that occur are effective at removing soluble, colloidal and particulate materials. The reactor can be designed for biological nitrification and denitrification, as well as for biological phosphorus removal.

The design must be based on an accurate estimation of the wastewater composition and volume. Treatment efficiency can be severely compromised if the plant is under- or over-dimensioned. Depending on the temperature, the solids retention time (SRT) in the reactor ranges from 3 to 5 days for BOD removal, to 3 to 18 days for nitrification.

The excess sludge requires treatment to reduce its water and organic content and to obtain a stabilized product suitable for end-use or final disposal. It is important to consider this step in the planning phase of the treatment plant.

To achieve specific effluent goals for BOD, nitrogen and phosphorus, different adaptations and modifications have been made to the basic activated sludge design. Well known modifications include sequencing batch reactors (SBR), oxidation ditches, extended aeration, moving beds and membrane bioreactors.

Appropriateness An activated sludge process is only appropriate for a Centralized Treatment facility with a well-trained staff, constant electricity and a highly developed management system that ensures that the facility is correctly operated and maintained.

Because of economies of scale and less fluctuating influent characteristics, this technology is more effective for the treatment of large volumes of flows.

An activated sludge process is appropriate in almost every climate. However, treatment capacity is reduced in colder environments.

Health Aspects/Acceptance Because of space requirements and odours, Centralized Treatment facilities are generally located in the periphery of densely populated areas. Although the effluent produced is of high quality, it still poses a health risk and should not be directly handled. In the excess sludge pathogens are substantially reduced, but not eliminated.

Operation & Maintenance Highly trained staff is required for maintenance and trouble-shooting. The mechanical equipment (mixers, aerators and pumps) must be constantly maintained. As well, the influent and effluent must be constantly monitored and the control parameters adjusted, if necessary, to avoid abnormalities that could kill the active biomass and the development of detrimental organisms which could impair the process (e.g., filamentous bacteria).

Pros & Cons

- + Resistant to organic and hydraulic shock loads
- + Can be operated at a range of organic and hydraulic loading rates
- + High reduction of BOD and pathogens (up to 99%)
- + High nutrient removal possible
- + Can be modified to meet specific discharge limits

- High energy consumption, a constant source of electricity is required
- High capital and operating costs
- Requires operation and maintenance by skilled personnel
- Prone to complicated chemical and microbiological problems
- Not all parts and materials may be locally available
- Requires expert design and construction
- Sludge and possibly effluent require further treatment and/or appropriate discharge

References & Further Reading

- Crites, R. and Tchobanoglous, G. (1998). *Small and Decentralized Wastewater Management Systems*. WCB/McGraw-Hill, New York, US. pp. 451-504.
(Comprehensive summary including solved problems)
- Ludwig, H. F. and Mohit, K. (2000). *Appropriate Technology for Municipal Sewerage/Excreta Management in Developing Countries, Thailand Case Study*. The Environmentalist 20 (3): 215-219.
(Assessment of the appropriateness of activated sludge for Thailand)
- von Sperling, M. and de Lemos Chernicharo, C. A. (2005). *Biological Wastewater Treatment in Warm Climate Regions, Volume Two*. IWA Publishing, London, UK.
Available at: www.iwaterwiki.org
- Tchobanoglous, G., Burton, F. L. and Stensel, H. D. (2004). *Wastewater Engineering: Treatment and Reuse*, Metcalf & Eddy, 4th Ed. (Internat. Ed.). McGraw-Hill, New York, US.
(Detailed design information)

Application Level: <input type="checkbox"/> Household <input checked="" type="checkbox"/> Neighbourhood <input checked="" type="checkbox"/> City	Management Level: <input type="checkbox"/> Household <input type="checkbox"/> Shared <input checked="" type="checkbox"/> Public	Inputs: <input checked="" type="checkbox"/> Sludge
		Outputs: <input checked="" type="checkbox"/> Sludge <input checked="" type="checkbox"/> Effluent

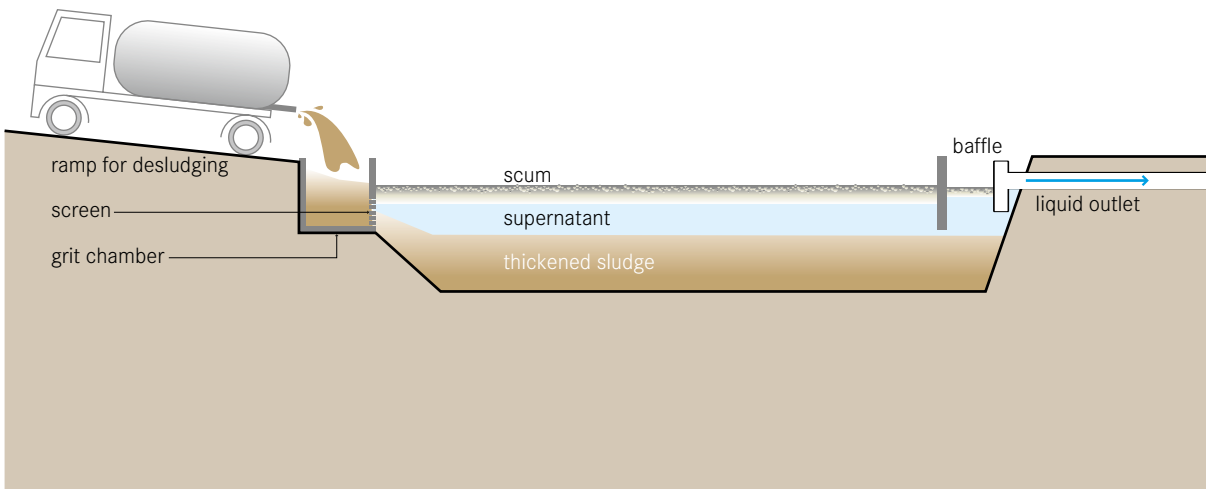

Sedimentation or thickening ponds are settling ponds that allow sludge to thicken and dewater. The effluent is removed and treated, while the thickened sludge can be further treated in a subsequent technology.

Faecal sludge is not a uniform product and, therefore, its treatment must be specific to the characteristics of the sludge. Sludge, which is still rich in organics and has not undergone significant degradation, is difficult to dewater. Conversely, sludge that has undergone significant anaerobic degradation, is more easily dewatered.

In order to be properly dried, fresh sludge rich in organic matter (e.g., latrine or public toilet sludge) must first be stabilized. Allowing the sludge to degrade anaerobically in sedimentation/thickening ponds can do this. The same type of pond can be used to thicken sludge which is already partially stabilized (e.g., originating from Septic Tanks, S.9), although it undergoes less degradation and requires more time to settle. The degradation process may actually hinder the settling of sludge because the gases produced bubble up and re-suspend the solids.

As the sludge settles and digests, the supernatant must be decanted and treated separately. The thickened sludge can then be dried or further composted.

Design Considerations Two tanks operating in parallel are required; one can be operated, while the other is emptied. To achieve maximum efficiency, loading and resting periods should not exceed 4 to 5 weeks, although much longer cycles are common. When a 4-week loading and 4-week resting cycle is used, total solids (TS) can be increased to 14% (depending on the initial concentration).

Appropriateness Sedimentation/thickening ponds are appropriate where there is inexpensive, available space located far from homes and businesses; it should be established at the border of the community. The thickened sludge is still infectious, although it is easier to handle and less prone to splashing and spraying. Trained staff for operation and maintenance is required to ensure proper functioning.

This is a low-cost option that can be installed in most hot and temperate climates. Excessive rain may prevent the sludge from properly settling and thickening.

Health Aspects/Acceptance Both the incoming and thickened sludge are pathogenic; therefore, workers should be equipped with proper protection (boots, gloves, and clothing). The thickened sludge is not sanitized and requires further treatment (at least in a drying process) before disposal or end-use.

The ponds may cause a nuisance for nearby residents due to bad odours and the presence of flies. Thus, they should be located sufficiently away from residential areas.

Operation & Maintenance Maintenance is an important aspect of well-functioning ponds, but it is not intensive. The discharging area must be maintained and kept clean to reduce the potential of disease transmission and nuisance (flies and odours). Solid waste that is discharged along with the sludge must be removed from the screen at the inlet of the ponds.



The thickened sludge must be mechanically removed (with a front end loader or other specialized equipment) after it has sufficiently thickened.

Pros & Cons

- + Thickened sludge is easier to handle and less prone to splashing and spraying
- + Can be built and repaired with locally available materials
- + Relatively low capital costs; low operating costs
- + No electrical energy is required
- Requires a large land area
- Odours and flies are normally noticeable
- Long storage times
- Requires front-end loader for desludging
- Requires expert design and construction
- Effluent and sludge require further treatment

References & Further Reading

- Heiness, U., Larmie, S. A. and Strauss, M. (1998). *Solids Separation and Pond Systems for the Treatment of Faecal Sludges in the Tropics – Lessons Learnt and Recommendations for Preliminary Design*. 2nd Ed. Report 05/98. Eawag (Department Sandec), Dübendorf, CH. Available at: www.sandec.ch
- Heiness, U., Larmie, S. A. and Strauss, M. (1999). *Characteristics of Faecal Sludges and Their Solids-Liquid Separation*. Eawag (Department Sandec), Dübendorf, CH. Available at: www.sandec.ch
- Montangero, A. and Strauss, M. (2002). *Faecal Sludge Treatment*. Lecture Notes, UNESCO-IHE, Delft, NL. Available at: www.sandec.ch
- Strande, L., Ronteltap, M. and Brdjanovic, D. (Eds.) (2014). *Faecal Sludge Management. Systems Approach for Implementation and Operation*. IWA Publishing, London, UK. Available at: www.sandec.ch (Detailed book compiling the current state of knowledge on all aspects related to FSM)

Application Level:	Management Level:	Inputs:  Sludge
<input type="checkbox"/> Household	<input type="checkbox"/> Household	Outputs:  Sludge  Effluent
<input checked="" type="checkbox"/> Neighbourhood	<input type="checkbox"/> Shared	
<input checked="" type="checkbox"/> City	<input checked="" type="checkbox"/> Public	

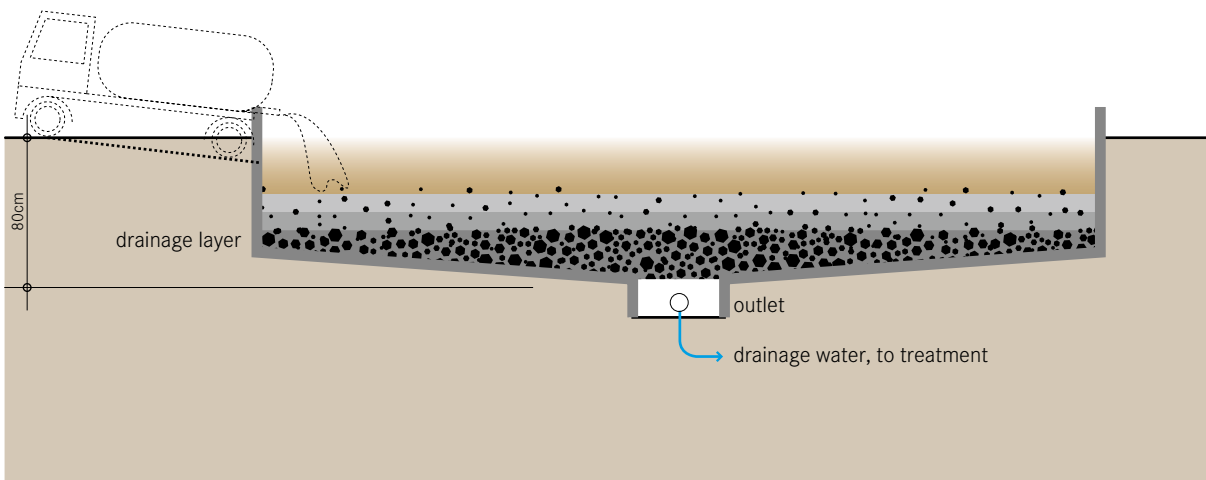

An unplanted drying bed is a simple, permeable bed that, when loaded with sludge, collects percolated leachate and allows the sludge to dry by evaporation. Approximately 50% to 80% of the sludge volume drains off as liquid or evaporates. The sludge, however, is not effectively stabilized or sanitized.

The bottom of the drying bed is lined with perforated pipes to drain the leachate away that percolates through the bed. On top of the pipes are layers of gravel and sand that support the sludge and allow the liquid to infiltrate and collect in the pipe. It should not be applied in layers that are too thick (maximum 20 cm), or the sludge will not dry effectively. The final moisture content after 10 to 15 days of drying should be approximately 60%. When the sludge is dried, it must be separated from the sand layer and transported for further treatment, end-use or final disposal. The leachate that is collected in the drainage pipes must also be treated properly, depending on where it is discharged.

Design Considerations The drainage pipes are covered by 3-5 graded layers of gravel and sand. The bottom layer should be coarse gravel and the top fine sand

(0.1 to 0.5 mm effective grain size). The top sand layer should be 250 to 300 mm thick because some sand will be lost each time the sludge is removed.

To improve drying and percolation, sludge application can alternate between two or more beds. The inlet should be equipped with a splash plate to prevent erosion of the sand layer and to allow for even distribution of the sludge.

Designing unplanted drying beds has to consider future maintenance because ensuring access to people and trucks for pumping in the sludge and removing the dried sludge is essential.

If installed in wet climates, the facility should be covered by a roof and special caution should be given to prevent the inflow of surface runoff.

Appropriateness Sludge drying is an effective way to decrease the volume of sludge, which is especially important when it has to be transported elsewhere for further treatment, end-use or disposal. The technology is not effective at stabilizing the organic fraction or decreasing the pathogenic content. Further storage or treatment (e.g., Co-Composting, T.16) of the dried sludge might be required.

Unplanted drying beds are appropriate for small to medium communities with populations up to 100,000 people, but larger ones also exist for huge urban agglomerations. They are best suited for rural and peri-urban areas where there is inexpensive, available space situated far from homes and businesses. If designed to service urban areas, unplanted drying beds should be at the border of the community, but within economic reach for Motorized Emptying operators.

This is a low-cost option that can be installed in most hot and temperate climates. Excessive rain may prevent the sludge from properly drying.

Health Aspects/Acceptance Both the incoming and dried sludge are pathogenic; therefore, workers should be equipped with proper protection (boots, gloves, and clothing). The dried sludge and effluent are not sanitized and may require further treatment or storage, depending on the desired end-use.

The drying bed may cause a nuisance for nearby residents due to bad odours and the presence of flies. Thus, it should be located sufficiently away from residential areas.

Operation & Maintenance Trained staff for operation and maintenance is required to ensure proper functioning.

Dried sludge can be removed after 10 to 15 days, but this depends on the climate conditions. Because some sand is lost with every removal of sludge, the top layer must be replaced when it gets thin. The discharge area must be kept clean and the effluent drains should be regularly flushed.





Pros & Cons

- + Good dewatering efficiency, especially in dry and hot climates
- + Can be built and repaired with locally available materials
- + Relatively low capital costs; low operating costs
- + Simple operation, only infrequent attention required
- + No electrical energy is required
- Requires a large land area
- Odours and flies are normally noticeable

- Labour intensive removal
- Limited stabilization and pathogen reduction
- Requires expert design and construction
- Leachate requires further treatment

References & Further Reading

- _ Crites, R. and Tchobanoglous, G. (1998). *Small and Decentralized Wastewater Management Systems*. WCB/McGraw-Hill, New York, US.
- _ Heiness, U. and Koottatep, T. (1998). *Use of Reed Beds for Faecal Sludge Dewatering. A Synopsis of Reviewed Literature and Interim Results of Pilot Investigations with Septage Treatment in Bangkok, Thailand*. Eawag (Department Sandec), Dübendorf, CH and AIT, Bangkok, TH.
Available at: www.sandec.ch
(Comparison to planted drying beds)
- _ Montangero, A. and Strauss, M. (2002). *Faecal Sludge Treatment*. Lecture Notes, UNESCO-IHE, Delft, NL.
Available at: www.sandec.ch
- _ Strande, L., Ronteltap, M. and Brdjanovic, D. (Eds.) (2014). *Faecal Sludge Management. Systems Approach for Implementation and Operation*. IWA Publishing, London, UK.
Available at: www.sandec.ch
(Detailed book compiling the current state of knowledge on all aspects related to FSM)
- _ Tchobanoglous, G., Burton, F. L. and Stensel, H. D. (2004). *Wastewater Engineering: Treatment and Reuse*, Metcalf & Eddy, 4th Ed. (Internat. Ed.). McGraw-Hill, New York, US.

Application Level:	Management Level:	Inputs:  Sludge
<input type="checkbox"/> Household	<input type="checkbox"/> Household	Outputs:  Sludge  Effluent  Biomass
<input checked="" type="checkbox"/> Neighbourhood	<input type="checkbox"/> Shared	
<input checked="" type="checkbox"/> City	<input checked="" type="checkbox"/> Public	

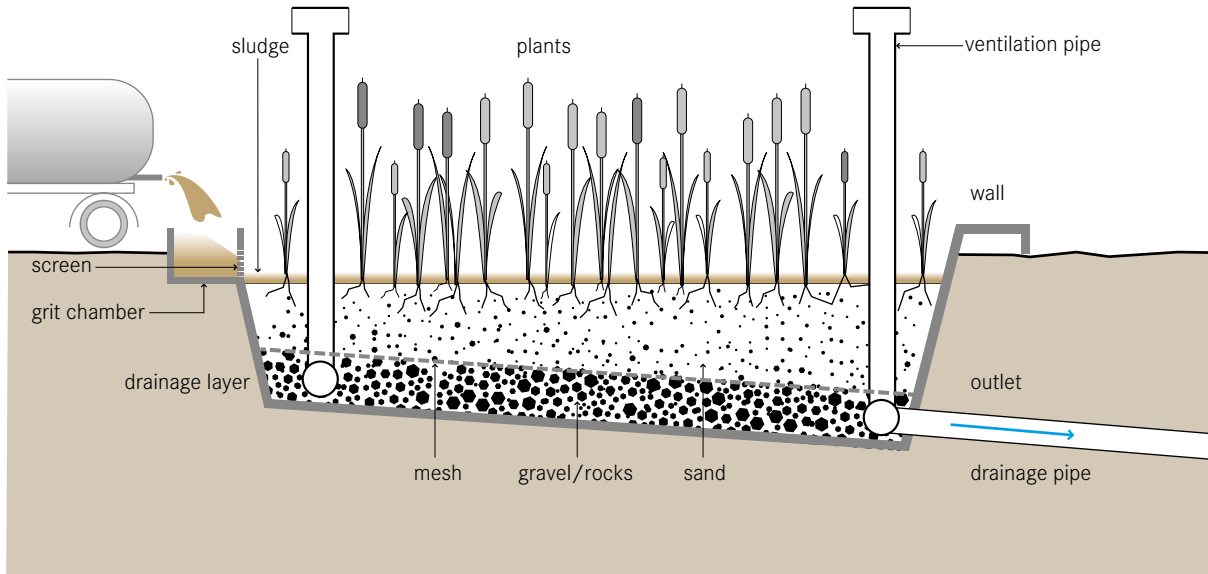

A planted drying bed is similar to an Unplanted Drying Bed (T.14), but has the added benefit of transpiration and enhanced sludge treatment due to the plants. The key improvement of the planted bed over the unplanted bed is that the filters do not need to be desludged after each feeding/drying cycle. Fresh sludge can be directly applied onto the previous layer; the plants and their root systems maintain the porosity of the filter.

This technology has the benefit of dewatering and stabilizing the sludge. Also, the roots of the plants create pathways through the thickening sludge that allow water to easily escape.

The appearance of the bed is similar to a Vertical Flow Constructed Wetland (T.9). The beds are filled with sand and gravel to support the vegetation. Instead of effluent, sludge is applied to the surface and the filtrate flows down through the subsurface where it is collected in drains.

Design Considerations Ventilation pipes connected to the drainage system contribute to aerobic conditions in the filter. A general design for layering the bed

is: (1) 250 mm of coarse gravel (grain diameter of 20 mm); (2) 250 mm of fine gravel (grain diameter of 5 mm); and (3) 100 to 150 mm of sand. Free space (1 m) should be left above the top of the sand layer to account for about 3 to 5 years of accumulation.

Reeds (*Phragmites* sp.), cattails (*Typha* sp.) antelope grass (*Echinochloa* sp.) and papyrus (*Cyperus papyrus*) are suitable plants, depending on the climate. Local, non-invasive species can be used if they grow in humid environments, are resistant to salty water and readily reproduce after cutting.

Sludge should be applied in layers between 75 to 100 mm thick and reapplied every 3 to 7 days, depending on the sludge characteristics, the environment and operating constraints. Sludge application rates of 100 to 250 kg/m²/year have been reported in warm tropical climates. In colder climates, such as northern Europe, rates up to 80 kg/m²/year are typical. Two or more parallel beds can be alternately used to allow for sufficient degradation and pathogen reduction of the top layer of sludge before it is removed.

The leachate that is collected in the drainage pipes must be treated properly, depending on where it is discharged.

Appropriateness This technology is effective at decreasing the sludge volume (down to 50%) through decomposition and drying, which is especially important when the sludge needs to be transported elsewhere for end-use or disposal.

Because of their area requirements, planted drying beds are most appropriate for small to medium communities with populations up to 100,000 people, but they can also be used in bigger cities. If designed to service urban areas, planted drying beds should be at the border of the community, but within economic reach for motorized emptying operators.

Health Aspects/Acceptance Because of the pleasing aesthetics, there should be few problems with acceptance, especially if located sufficiently away from dense housing. Undisturbed plantations can attract wildlife, including poisonous snakes.

Faecal sludge is hazardous and anyone working with it should wear protective clothing, boots and gloves. The degree of pathogen reduction in the sludge will vary with the climate. Depending on the desired end-use, further storage and drying might be required.

Operation & Maintenance Trained staff for operation and maintenance is required to ensure proper functioning. The drains must be maintained and the effluent properly collected and disposed of. The plants should have grown sufficiently before applying the sludge. The acclimation phase is crucial and requires much care. The plants should be periodically thinned and/or harvested. After 3 to 5 years the sludge can be removed.

Pros & Cons

- + Can handle high loading
- + Better sludge treatment than in Unplanted Drying Beds
- + Can be built and repaired with locally available materials
- + Relatively low capital costs; low operating costs
- + Fruit or forage growing in the beds can generate income
- + No electrical energy required
- Requires a large land area

- Odours and flies may be noticeable
- Long storage times
- Labour intensive removal
- Requires expert design and construction
- Leachate requires further treatment

References & Further Reading

- Crites, R. and Tchobanoglous, G. (1998). *Small and Decentralized Wastewater Management Systems*. WCB/McGraw-Hill, New York, US.
- Heinss, U. and Koottatep, T. (1998). *Use of Reed Beds for Faecal Sludge Dewatering. A Synopsis of Reviewed Literature and Interim Results of Pilot Investigations with Septage Treatment in Bangkok, Thailand*. Eawag (Department Sandec), Dübendorf, CH and AIT, Bangkok, TH. Available at: www.sandec.ch
- Kengne Noumsi, I. M. (2008). *Potentials of Sludge Drying Beds Vegetated with *Cyperus papyrus* L. and *Echinochloa pyramidalis* (Lam.) Hitchc. & Chase for Faecal Sludge Treatment in Tropical Regions* [PhD dissertation]. University of Yaounde, Yaounde, CM. Available at: www.north-south.unibe.ch
- Koottatep, T., Surinkul, N., Polprasert, C., Kamal, A. S. M., Koné, D., Montangero, A., Heinss, U. and Strauss, M. (2005). *Treatment of Septage in Constructed Wetlands in Tropical Climate – Lessons Learnt after Seven Years of Operation*. *Water Science & Technology* 51 (9): 119-126. Available at: www.sandec.ch
- Strande, L., Ronteltap, M. and Brdjanovic, D. (Eds.) (2014). *Faecal Sludge Management. Systems Approach for Implementation and Operation*. IWA Publishing, London, UK. Available at: www.sandec.ch (Detailed book compiling the current state of knowledge on all aspects related to FSM)
- Tchobanoglous, G., Burton, F. L. and Stensel, H. D. (2004). *Wastewater Engineering: Treatment and Reuse*, Metcalf & Eddy, 4th Ed. (Internat. Ed.). McGraw-Hill, New York, US. p. 1578.

Application Level: <input type="checkbox"/> Household <input checked="" type="checkbox"/> Neighbourhood <input checked="" type="checkbox"/> City	Management Level: <input type="checkbox"/> Household <input checked="" type="checkbox"/> Shared <input checked="" type="checkbox"/> Public	Inputs: <input checked="" type="checkbox"/> Sludge <input checked="" type="checkbox"/> Organics
		Outputs: <input checked="" type="checkbox"/> Compost

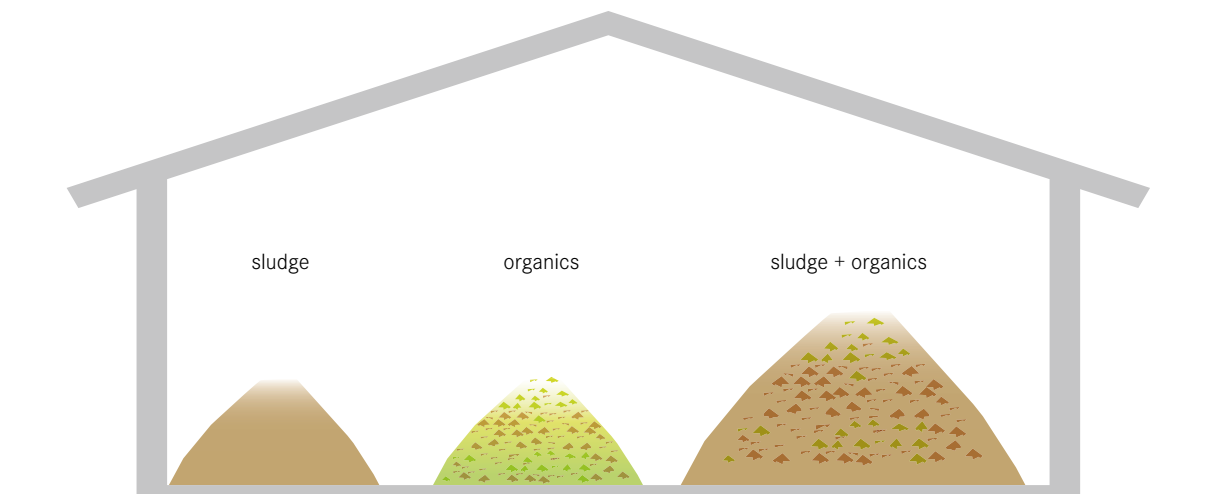

Co-composting is the controlled aerobic degradation of organics, using more than one feedstock (faecal sludge and organic solid waste). Faecal sludge has a high moisture and nitrogen content, while biodegradable solid waste is high in organic carbon and has good bulking properties (i.e., it allows air to flow and circulate). By combining the two, the benefits of each can be used to optimize the process and the product.

There are two types of co-composting designs: open and in-vessel. In open composting, the mixed material (sludge and solid waste) is piled into long heaps called windrows and left to decompose. Windrow piles are periodically turned to provide oxygen and ensure that all parts of the pile are subjected to the same heat treatment. In-vessel composting requires controlled moisture and air supply, as well as mechanical mixing. Therefore, it is not generally appropriate for decentralized facilities. Although the composting process seems like a simple, passive technology, a well-functioning facility requires careful planning and design to avoid failure.

Design Considerations The facility should be located close to the sources of organic waste and faecal sludge to minimize transport costs, but still at a distance away from homes and businesses to minimize nuisances. Depending on the climate and available space, the facility may be covered to prevent excess evaporation and/or provide protection from rain and wind.

For dewatered sludge, a ratio of 1:2 to 1:3 of sludge to solid waste should be used. Liquid sludge should be used at a ratio of 1:5 to 1:10 of sludge to solid waste. Windrow piles should be at least 1 m high and insulated with compost or soil to promote an even distribution of heat inside the pile.

Appropriateness A co-composting facility is only appropriate when there is an available source of well-sorted biodegradable solid waste. Solid waste containing plastics and garbage must first be sorted. When carefully done, co-composting can produce a clean, pleasant, beneficial soil conditioner.

Since moisture plays an important role in the composting process, covered facilities are especially recommended where there is heavy rainfall.

Apart from technical considerations, composting only makes sense if there is a demand for the product (from paying customers). In order to find buyers, a consistent and good quality compost has to be produced; this depends on good initial sorting and a well-controlled thermophilic process.

Health Aspects/Acceptance Maintaining the temperature in the pile between 55 and 60 °C can reduce the pathogen load in sludge to a level safe to touch and work with. Although the finished compost can be safely handled, care should be taken when dealing with the sludge, regardless of the previous treatment. If the material is found to be dusty, workers should wear protective clothing and use appropriate respiratory equipment. Proper ventilation and dust control are important.

Operation & Maintenance The mixture must be carefully designed so that it has the proper C:N ratio, moisture and oxygen content. If facilities exist, it would be useful to monitor helminth egg inactivation as a proxy measure of sterilization.

A well-trained staff is necessary for the operation and maintenance of the facility. Maintenance staff must carefully monitor the quality of the input material, and keep track of the inflows, outflows, turning schedules, and maturing times to ensure a high quality product. Forced aeration systems must be carefully controlled and monitored.

Turning must be periodically done with either a front-end loader or by hand. Robust grinders for shredding large pieces of solid waste (i.e., small branches and coconut shells) and pile turners help to optimize the process, reduce manual labour, and ensure a more homogenous end product.

Pros & Cons

- + Relatively straightforward to set up and maintain with appropriate training
- + Provides a valuable resource that can improve local agriculture and food production
- + A high removal of helminth eggs is possible (< 1 viable egg/g TS)

- + Can be built and repaired with locally available materials
- + Low capital and operating costs
- + No electrical energy required
- Requires a large land area (that is well located)
- Long storage times
- Requires expert design and operation by skilled personnel
- Labour intensive
- Compost is too bulky to be economically transported over long distances

References & Further Reading

- Hoornweg, D., Thomas, L. and Otten, L. (2000). *Composting and Its Applicability in Developing Countries*. Urban Waste Management Working Paper Series No. 8. The World Bank, Washington, D.C., US.
Available at: documents.worldbank.org/curated/en/home
- Koné, D., Cofie, O., Zurbrügg, C., Gallizzi, K., Moser, D., Drescher, S. and Strauss, M. (2007). *Helminth Eggs Inactivation Efficiency by Faecal Sludge Dewatering and Co-Composting in Tropical Climates*. *Water Research* 41 (19): 4397-4402.
- Obeng, L. A. and Wright, F. W. (1987). *Integrated Resource Recovery. The Co-Composting of Domestic Solid and Human Wastes*. The World Bank and UNDP, Washington, D.C., US.
Available at: documents.worldbank.org/curated/en/home
- Rouse, J., Rothenberger, S. and Zurbrügg, C. (2008): *Marketing Compost, a Guide for Compost Producers in Low and Middle-Income Countries*. Eawag (Department Sandec), Dübendorf, CH.
Available at: www.sandec.ch
- Strande, L., Ronteltap, M. and Brdjanovic, D. (Eds.) (2014). *Faecal Sludge Management. Systems Approach for Implementation and Operation*. IWA Publishing, London, UK.
Available at: www.sandec.ch
(Detailed book compiling the current state of knowledge on all aspects related to FSM)
- Strauss, M., Drescher, S., Zurbrügg, C., Montangero, A., Cofie, O. and Drechsel, P. (2003). *Co-Composting of Faecal Sludge and Municipal Organic Waste. A Literature and State-of-Knowledge Review*. Eawag (Department Sandec), Dübendorf, CH and IWMI, Accra, GH.
Available at: www.sandec.ch

Application Level:

- ★★ Household
- ★★ Neighbourhood
- ★★ City

Management Level:

- ★★ Household
- ★★ Shared
- ★★ Public

Inputs: Sludge Blackwater
 Brownwater Organics

Outputs: Sludge Biogas

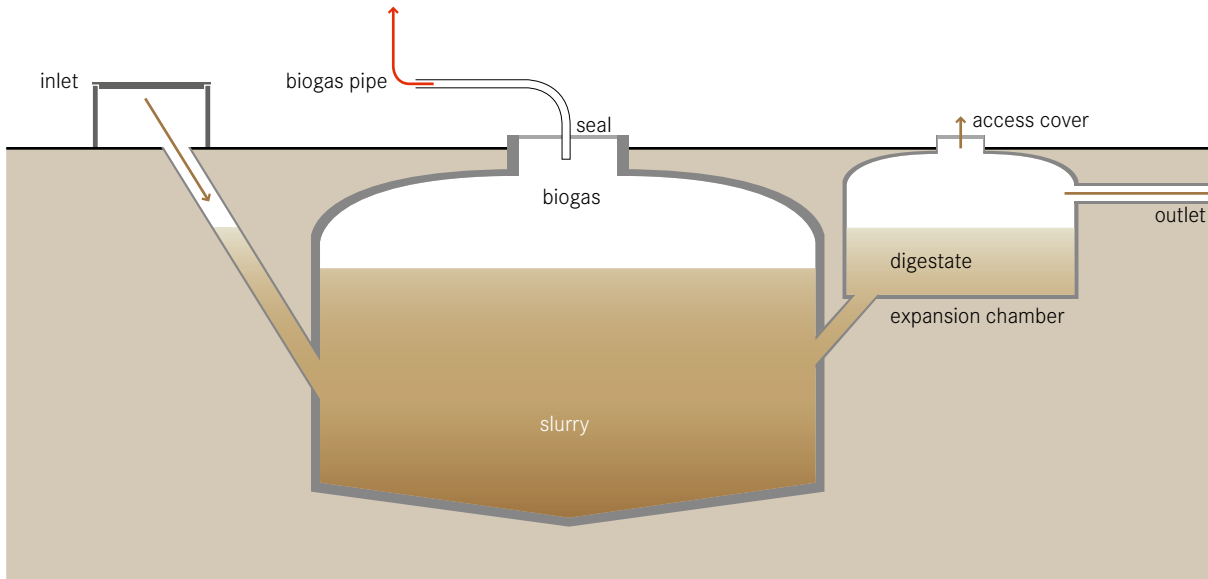

A biogas reactor or anaerobic digester is an anaerobic treatment technology that produces (a) a digested slurry (digestate) that can be used as a fertilizer and (b) biogas that can be used for energy. Biogas is a mix of methane, carbon dioxide and other trace gases which can be converted to heat, electricity or light.

A biogas reactor is an airtight chamber that facilitates the anaerobic degradation of blackwater, sludge, and/or biodegradable waste. It also facilitates the collection of the biogas produced in the fermentation processes in the reactor. The gas forms in the slurry and collects at the top of the chamber, mixing the slurry as it rises. The digestate is rich in organics and nutrients, almost odourless and pathogens are partly inactivated.

Design Considerations Biogas reactors can be brick-constructed domes or prefabricated tanks, installed above or below ground, depending on space, soil characteristics, available resources and the volume of waste generated. They can be built as fixed dome or floating dome digesters. In the fixed dome, the volume of the reactor is constant. As gas is generated it

exerts a pressure and displaces the slurry upward into an expansion chamber. When the gas is removed, the slurry flows back into the reactor. The pressure can be used to transport the biogas through pipes. In a floating dome reactor, the dome rises and falls with the production and withdrawal of gas. Alternatively, it can expand (like a balloon). To minimize distribution losses, the reactors should be installed close to where the gas can be used.

The hydraulic retention time (HRT) in the reactor should be at least 15 days in hot climates and 25 days in temperate climates. For highly pathogenic inputs, a HRT of 60 days should be considered. Normally, biogas reactors are operated in the mesophilic temperature range of 30 to 38 °C. A thermophilic temperature of 50 to 57 °C would ensure the pathogens destruction, but can only be achieved by heating the reactor (although in practice, this is only found in industrialized countries). Often, biogas reactors are directly connected to private or public toilets with an additional access point for organic materials. At the household level, reactors can be made out of plastic containers or bricks. Sizes can vary from 1,000 L for a single family up to 100,000 L for institutional or public toilet applications. Because

the digestate production is continuous, there must be provisions made for its storage, use and/or transport away from the site.

Appropriateness This technology can be applied at the household level, in small neighbourhoods or for the stabilization of sludge at large wastewater treatment plants. It is best used where regular feeding is possible. Often, a biogas reactor is used as an alternative to a Septic Tank (S.9), since it offers a similar level of treatment, but with the added benefit of biogas. However, significant gas production cannot be achieved if blackwater is the only input. The highest levels of biogas production are obtained with concentrated substrates, which are rich in organic material, such as animal manure and organic market or household waste. It can be efficient to co-digest blackwater from a single household with manure if the latter is the main source of feedstock. Greywater should not be added as it substantially reduces the HRT. Wood material and straw are difficult to degrade and should be avoided in the substrate. Biogas reactors are less appropriate for colder climates as the rate of organic matter conversion into biogas is very low below 15 °C. Consequently, the HRT needs to be longer and the design volume substantially increased.

Health Aspects/Acceptance The digestate is partially sanitized but still carries a risk of infection. Depending on its end-use, further treatment might be required. There are also dangers associated with the flammable gases that, if mismanaged, could be harmful to human health.

Operation & Maintenance If the reactor is properly designed and built, repairs should be minimal. To start the reactor, it should be inoculated with anaerobic bacteria, e.g., by adding cow dung or Septic Tank sludge. Organic waste used as substrate should be shredded and mixed with water or digestate prior to feeding. Gas equipment should be carefully and regularly cleaned so that corrosion and leaks are prevented. Grit and sand that have settled to the bottom should be removed. Depending on the design and the inputs, the reactor should be emptied once every 5 to 10 years.

Pros & Cons

- + Generation of renewable energy
- + Small land area required (most of the structure can be built underground)
- + No electrical energy required
- + Conservation of nutrients
- + Long service life
- + Low operating costs
- Requires expert design and skilled construction
- Incomplete pathogen removal, the digestate might require further treatment
- Limited gas production below 15 °C

References & Further Reading

- CMS (1996). *Biogas Technology: A Training Manual for Extension*. FAO/TCP/NEP/4451-T. Consolidated Management Services, Kathmandu, NP. Available at: www.fao.org
- GTZ (1998). *Biogas Digest. Volume I-IV*. Information and Advisory Service on Appropriate Technology (ISAT). Deutsche Gesellschaft für Technische Zusammenarbeit (GTZ) GmbH, Eschborn, DE. Available at: www.susana.org/library
- Mang, H.-P. and Li, Z. (2010). *Technology Review of Biogas Sanitation. Draft – Biogas Sanitation for Blackwater, Brown Water, or for Excreta Treatment and Reuse in Developing Countries*. Gesellschaft für Internationale Zusammenarbeit (GIZ) GmbH, Eschborn, DE. Available at: www.susana.org/library
- Ulrich, A. (Ed.), Reuter, S. (Ed.), Gutterer, B. (Ed.), Sasse, L., Panzerbieter, T. and Reckerzügel, T. (2009). *Decentralised Wastewater Treatment Systems (DEWATS) and Sanitation in Developing Countries. A Practical Guide*. WEDC, Loughborough University, Leicestershire, UK.
- Vögeli, Y., Lohri, C. R., Gallardo, A., Diener, S. and Zurbrügg, C. (2014). *Anaerobic Digestion of Biowaste in Developing Countries. Practical Information and Case Studies*. Eawag (Department Sandec), Dübendorf, CH. Available at: www.sandec.ch

Application Level: <input type="checkbox"/> Household <input checked="" type="checkbox"/> Neighbourhood <input checked="" type="checkbox"/> City	Management Level: <input type="checkbox"/> Household <input checked="" type="checkbox"/> Shared <input checked="" type="checkbox"/> Public	Inputs: <input checked="" type="checkbox"/> Effluent
		Outputs: <input checked="" type="checkbox"/> Effluent

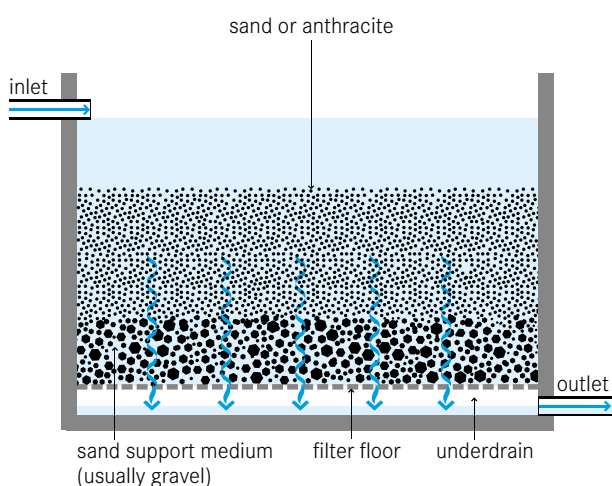

tertiary filtration (e.g., depth filtration)

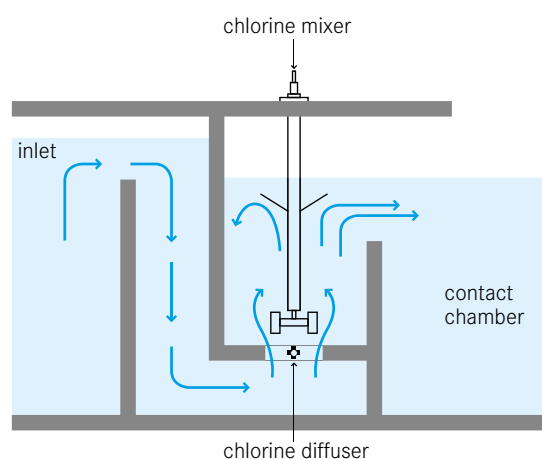

disinfection (e.g., chlorination)

Depending on the end-use of the effluent or national standards for discharge in water bodies, a post-treatment step may be required to remove pathogens, residual suspended solids and/or dissolved constituents. Tertiary filtration and disinfection processes are most commonly used to achieve this.

Post-treatment is not always necessary and a pragmatic approach is recommended. The effluent quality should match the intended end-use practice or the quality of the receiving water body. The WHO Guidelines for the Safe Use of Wastewater, Excreta and Greywater provide useful information on the assessment and management of risks associated with microbial hazards and toxic chemicals.

Among a wide range of tertiary and advanced treatment technologies for effluent, the most widespread include tertiary filtration and disinfection processes.

Tertiary Filtration Filtration processes can be classified as either depth (or packed-bed) filtration or surface filtration processes. Depth filtration involves the removal of residual suspended solids by passing the liquid through a filter bed comprised of a granular fil-

ter medium (e.g., sand). If activated carbon is used as a filter medium, the dominating process is adsorption. Activated carbon adsorbers not only remove a variety of organic and inorganic compounds, they also eliminate taste and odour. Surface filtration involves the removal of particulate material by mechanical sieving as the liquid passes through a thin septum (i.e., filter layer). Membranes are also surface filters. Low pressure membrane filtration processes (including gravity-driven membrane filters) are being developed. Depth filtration is successfully used to remove protozoan cysts and oocysts, while ultrafiltration membranes can also reliably eliminate bacteria and viruses.

Disinfection The destruction, inactivation, or removal of pathogenic microorganisms can be achieved by chemical, physical, or biological means. Due to its low cost, high availability and easy operation, chlorine has historically been the disinfectant of choice for treating wastewater. Chlorine oxidizes organic matter, including microorganisms and pathogens. Concerns about harmful disinfection by-products and chemical safety, however, have increasingly led to chlorination being replaced by alternative disinfection systems, such as ultraviolet

(UV) radiation and ozonation (O₃). UV radiation is found in sunlight and kills viruses and bacteria. Thus, disinfection naturally takes place in shallow ponds (see T.5). UV radiation can also be generated through special lamps, which can be installed in a channel or pipe. Ozone is a powerful oxidant and is generated from oxygen in an energy-intensive process. It degrades both organic and inorganic pollutants, including odour-producing agents. Similar to chlorine, the formation of unwanted by-products is one of the problems associated with the use of ozone as a disinfectant.

Appropriateness The decision to install a post-treatment technology depends mainly on the quality requirement for the desired end-use of the effluent and/or national standards. Other factors are the effluent characteristics, budget, availability of materials, and O&M capacity.

Pathogens tend to be masked by suspended solids in unfiltered secondary effluent. Therefore, a filtration step prior to disinfection brings about much better results with fewer chemicals.

Membrane filters are costly and require expert know-how for O&M, especially, to avoid damaging the membrane. In activated carbon adsorption the filter material is contaminated after usage and needs proper treatment/disposal. Chlorine should not be used if the water contains significant amounts of organic matter, as disinfection by-products can form. Ozonation costs are generally higher compared to other disinfection methods.

Health Aspects/Acceptance With both chlorine and ozone disinfection, by-products may form and threaten environmental and human health. There are also safety concerns related to the handling and storage of liquid chlorine. Activated carbon adsorption and ozonation can remove unpleasant colours and odours, increasing the acceptance of reusing reclaimed water.

Operation & Maintenance All post-treatment methods require continuous monitoring (influent and effluent quality, head loss of filters, dosage of disinfectants, etc.) to ensure a high performance.

Due to the accumulation of solids and microbial growth, the effectiveness of sand, membrane and activated

carbon filters decreases over time. Frequent cleaning (backwashing) or replacement of the filter material is, therefore, required. For chlorination, trained personnel are required to determine the right dosage of chlorine and ensure proper mixing. Ozone must be generated onsite because it is chemically unstable and rapidly decomposes to oxygen. In UV disinfection, the UV lamp needs regular cleaning and annual replacement.

Pros & Cons

- + Additional removal of pathogens and/or chemical contaminants
- + Allows for direct reuse of the treated wastewater
- Skills, technology, spare parts and materials may not be locally available
- Capital and operating costs can be very high
- Some technologies require a constant source of electricity and/or chemicals
- Requires continuous monitoring of influent and effluent
- Filter materials need regular backwashing or replacement
- Chlorination and ozonation can form toxic disinfection by-products

References & Further Reading

- NWRI (2012). *Ultraviolet Disinfection. Guidelines for Drinking Water and Water Reuse*. 3rd Ed. National Water Research Institute and Water Research Foundation, Fountain Valley, CA, US.
Available at: www.nwri-usa.org
- Robbins, D. M. and Ligon, G.C. (2014). *How to Design Wastewater Systems for Local Conditions in Developing Countries*. IWA Publishing, London, UK.
- SSWM Toolbox.
www.sswm.info/category/implementation-tools/water-purification (last accessed February 2014)
- Tchobanoglous, G., Burton, F. L. and Stensel, H. D. (2004). *Wastewater Engineering: Treatment and Reuse*, Metcalf & Eddy, 4th Ed. (Internat. Ed.). McGraw-Hill, New York, US. pp. 1035-1330.
- WHO (2006). *Guidelines for the Safe Use of Wastewater, Excreta and Greywater. Volume 2: Wastewater Use in Agriculture*. World Health Organization, Geneva, CH.
Available at: www.who.int













This section presents the different technologies and methods with which products are ultimately returned to the environment, either as useful resources or reduced-risk materials. If there is an end-use for the output products, they can be applied or used. Otherwise, they should be disposed of in ways that are least harmful to the public and the environment. Where relevant, the WHO Guidelines for the Safe Use of Wastewater, Excreta and Greywater are referenced in the technology information sheets.

- D.1 Fill and Cover/Arborloo
- D.2 Application of Stored Urine
- D.3 Application of Dehydrated Faeces
- D.4 Application of Pit Humus and Compost
- D.5 Application of Sludge
- D.6 Irrigation
- D.7 Soak Pit
- D.8 Leach Field
- D.9 Fish Pond
- D.10 Floating Plant Pond
- D.11 Water Disposal/Groundwater Recharge
- D.12 Surface Disposal and Storage
- D.13 Biogas Combustion

In any given context, the technology choice generally depends on the following factors:

- Type and quality of products
- Socio-cultural acceptance
- Local demands
- Legal aspects
- Availability of materials and equipment
- Availability of space
- Soil and groundwater characteristics



Application Level:	Management Level:	Inputs:  Excreta  Faeces  Organics (+  Anal Cleansing Water) (+  Dry Cleansing Materials)
 Household	 Household	Outputs:  Biomass)
 Neighbourhood	 Shared	
 City	 Public	

1

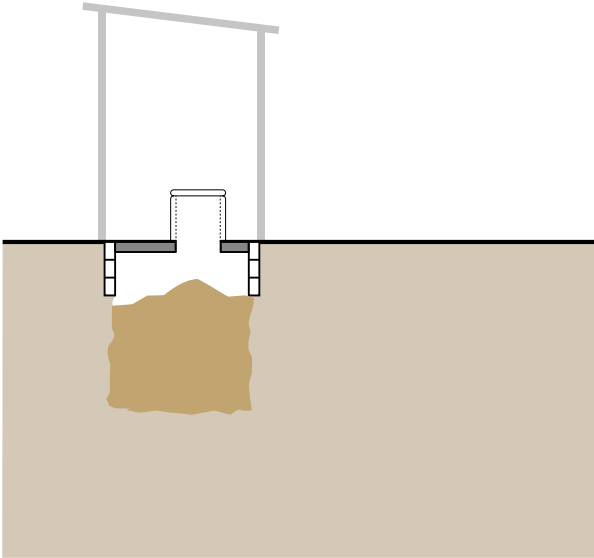

2

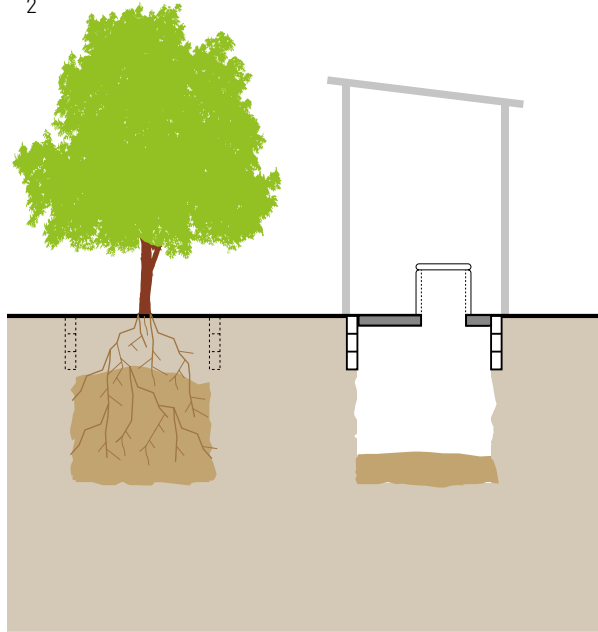

To decommission a pit, it can simply be filled with soil and covered. Although there is no benefit, the full pit poses no immediate health risk and the contents will degrade naturally over time. Alternatively, the Arborloo is a shallow pit that is filled with excreta and soil/ash and then covered with soil; a tree planted on top of the nutrient-rich pit will grow vigorously.

When a Single Pit (S.2) or a Single VIP (S.3) is full and cannot be emptied, “fill and cover”, i.e., filling the remainder of the pit and covering it is an option, albeit one with limited benefits to the environment and the user.

The Arborloo is a shallow pit on which a tree can be planted after it is full, while the superstructure, ring beam and slab are moved to a new pit. Before the Arborloo is used, a layer of leaves is put on the bottom of the empty pit. A cup of soil, ash or a mixture of the two should be dumped into the pit to cover excreta after each defecation. If they are available, leaves can also occasionally be added to improve the porosity and air content of the pile. When the pit is full (usually every 6 to 12 months), the top 15 cm is filled with soil and a tree is planted. Banana, papaya

and guava trees (among many) have all proven to be successful.

Design Considerations An Arborloo is only an option if the site is suitable for a tree to grow. Therefore, when selecting the pit location, users should already take the space and site conditions required for a new tree into account (e.g., distance to houses).

A shallow pit, about 1 m deep, is needed for an Arborloo. It should not be lined as any lining would prevent the tree or plant from properly growing.

A tree should not be planted, however, directly in the raw excreta. It should be planted in the soil on top of the pit, allowing its roots to penetrate the pit contents as it grows. It may be best to wait for the rainy season before planting it if water is scarce.

Appropriateness Filling and covering a pit is an adequate solution when emptying is not possible and when there is space to continuously dig new pits.

The Arborloo can be applied in rural, peri-urban, and even denser areas if enough space is available.

Planting a tree in the abandoned pit is a good way to reforest an area, provide a sustainable source of fresh

fruit and prevent people from falling into old pit sites. Other plants such as tomatoes and pumpkins can also be planted on top of the pit if trees are not available. Depending on the local conditions, however, the content of a covered pit or Arborloo could contaminate groundwater resources until it is entirely decomposed.

Health Aspects/Acceptance There is minimal risk of infection if the pit is properly covered and clearly marked. It may be preferable to cover the pit and to plant a tree rather than emptying it, especially if there is no appropriate technology available to remove and treat the faecal sludge.

Users do not come in contact with the faecal material and, thus, there is a very low risk of pathogen transmission.

Arborloo demonstration projects that allow for the participation of community members are useful ways to display the ease of the system, its inoffensive nature, and the nutrient value of human excreta.

Operation & Maintenance A cup of soil and/or ash should be added to the pit after each defecation and leaves should be periodically added. Also, the contents of the pit should be periodically levelled to prevent a cone shape from forming in the middle.



There is little maintenance associated with a closed pit other than taking care of the tree or plant. Trees planted in abandoned pits should be regularly watered. A small fence of sticks and sacks should be constructed around the sapling to protect it from animals.

Pros & Cons

- + Technique simple to apply for all users
- + Low costs
- + Low risk of pathogen transmission
- + May encourage income generation (tree planting and fruit production)
- New pit must be dug; the old pit cannot be re-used
- Covering a pit or planting a tree does not eliminate the risk of groundwater contamination

References & Further Reading

- _ Hebert, P. (2010). *Rapid Assessment of CRS Experience with Arborloos in East Africa*. Catholic Relief Service (CRS), Baltimore, US.
Available at: www.susana.org/library
- _ Morgan, P. R. (2004). *An Ecological Approach to Sanitation in Africa. A Compilation of Experiences*. Aquamor, Harare, ZW. Chapter 10: The Usefulness of Urine.
Available at: www.ecosanres.org
- _ Morgan, P. R. (2007). *Toilets That Make Compost. Low-Cost, Sanitary Toilets That Produce Valuable Compost for Crops in an African Context*. Stockholm Environment Institute, Stockholm, SE. pp. 81-90.
Available at: www.ecosanres.org
- _ Morgan, P. R. (2009). *Ecological Toilets. Start Simple and Upgrade from Arborloo to VIP*. Stockholm Environment Institute, Stockholm, SE.
Available at: www.ecosanres.org
- _ NWP (2006). *Smart Sanitation Solutions. Examples of Innovative, Low-Cost Technologies for Toilets, Collection, Transportation, Treatment and Use of Sanitation Products*. Netherlands Water Partnership, The Hague, NL. p. 51.
Available at: www.ircwash.org

Application Level: ★★ Household ★★ Neighbourhood ★★ City	Management Level: ★★ Household ★★ Shared ★★ Public	Inputs:  Stored Urine
		Outputs:  Biomass

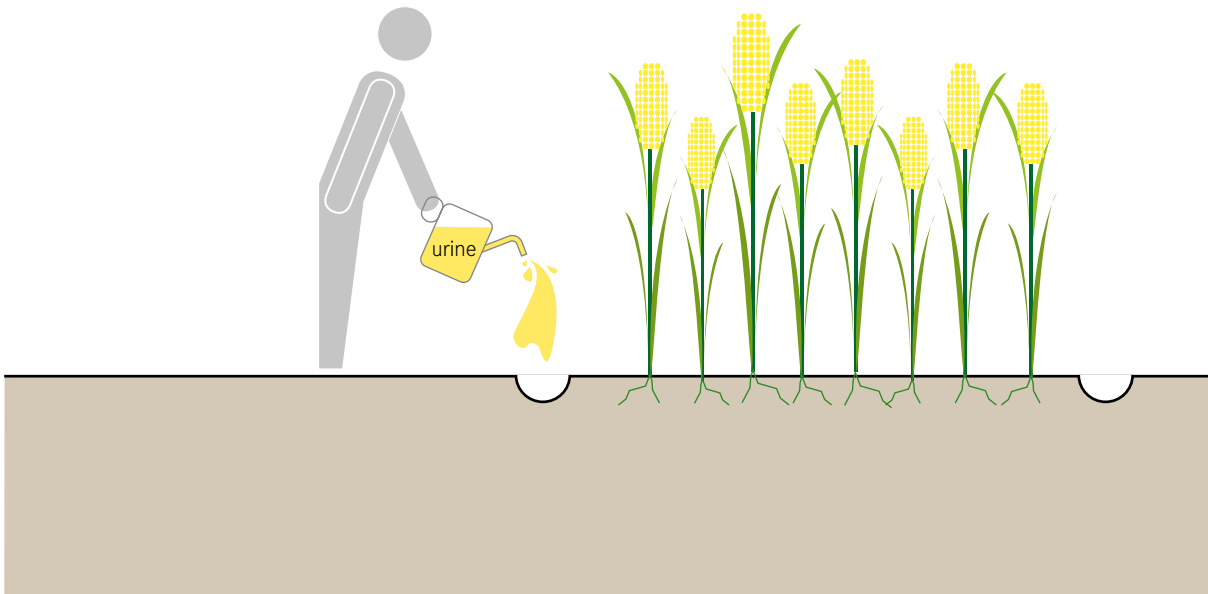

Stored urine is a concentrated source of nutrients that can be applied as a liquid fertilizer in agriculture and replace all or some commercial chemical fertilizers.

The guidelines for urine use are based on storage time and temperature (see WHO guidelines on excreta use in agriculture for specific requirements). However, it is generally accepted that if urine is stored for at least 1 month, it will be safe for agricultural application at the household level. If urine is used for crops that are eaten by people other than the urine producer, it should be stored beforehand for 6 months.

Another beneficial use of urine is as an additive to enrich compost. Technologies for the production of urine-based fertilizers are currently under research (e.g., struvite, see *Emerging Sanitation Technologies*, p. 166).

From normal, healthy people, urine is virtually free of pathogens. Urine also contains the majority of nutrients that are excreted by the body. Its composition varies depending on diet, gender, climate, water intake, etc., but roughly 88% of nitrogen, 61% of phosphorus and 74% of potassium excreted from the body is in urine.

Design Considerations Stored urine should not be applied directly to plants because of its high pH and concentrated form. Instead, it can be:

- 1) mixed undiluted into soil before planting;
- 2) poured into furrows, but at a sufficient distance away from the roots of the plants and immediately covered (although this should take place no more than once or twice during the growing season); and
- 3) diluted several times, whereby it can be frequently used around plants (up to two times weekly).

The optimal application rate depends on the nitrogen demand and tolerance of the crop on which it will be used, the nitrogen concentration of the liquid, as well as the rate of ammonia loss during application. As a general rule of thumb, one can assume that 1 m² of cropland can receive 1.5 L of urine per growing season (this quantity corresponds to the daily urine production of one person and to 40–110 kg N/ha). The urine of one person during one year is, thus, sufficient to fertilize 300 to 400 m² of cropland.

A 3:1 mix of water and urine is an effective dilution for vegetables, although the correct amount depends on the soil and the type of vegetables. If diluted urine is used in an irrigation system, it is referred to as “fertiga-

tion” (see D.6). During the rainy season, urine can also be applied directly into small holes near plants; then it is diluted naturally.

Appropriateness Urine is especially beneficial for crops lacking in nitrogen. Examples of some crops that grow well with urine include: maize, rice, millet, sorghum, wheat, chard, turnip, carrots, kale, cabbage, lettuce, bananas, paw-paw, and oranges. Urine application is ideal for rural and peri-urban areas where agricultural lands are close to the point of urine collection. Households can use their own urine on their own plot of land. Alternatively, if facilities and infrastructure exist, urine can be collected at a semi-centralized location for distribution and transport to agricultural land. Regardless, the most important aspect is that there is a need for nutrients from fertilizer for agriculture which can be supplied by the stored urine. When there is no such need, the urine can become a source of pollution and a nuisance.

Health Aspects/Acceptance Urine poses a minimal risk of infection, especially when it has been stored for an extended period of time. Yet, urine should be carefully handled and should not be applied to crops less than one month before they are harvested. This waiting period is especially important for crops that are consumed raw (refer to WHO guidelines for specific guidance).

Social acceptance may be difficult. Stored urine has a strong smell and some may find it offensive to work with it or to have it nearby. If urine is diluted and/or immediately tilled into the earth, however, its smell can be reduced. The use of urine may be less accepted in urban or peri-urban areas when household gardens are close to peoples’ homes than in rural areas where houses and crop land are kept separate.

Operation & Maintenance Over time, some minerals in urine will precipitate (especially, calcium and magnesium phosphates). Equipment that is used to collect, transport or apply urine (i.e., watering cans with small holes) may become clogged over time. Most deposits can easily be removed with hot water



and a bit of acid (vinegar), or in more extreme cases, manually chipped off.

Pros & Cons

- + May encourage income generation (improved yield and productivity of plants)
- + Reduces dependence on costly chemical fertilizers
- + Low risk of pathogen transmission
- + Low costs
- Urine is heavy and difficult to transport
- Smell may be offensive
- Labour intensive
- Risk of soil salinization if the soil is prone to the accumulation of salts
- Social acceptance may be low in some areas

References & Further Reading

- Morgan, P. R. (2004). *An Ecological Approach to Sanitation in Africa. A Compilation of Experiences*. Aquamor, Harare, ZW. Chapter 10: The Usefulness of Urine. Available at: www.ecosanres.org
- Morgan, P. R. (2007). *Toilets That Make Compost. Low-Cost, Sanitary Toilets That Produce Valuable Compost for Crops in an African Context*. Stockholm Environment Institute, Stockholm, SE. Available at: www.ecosanres.org
- von Münch, E. and Winker, M. (2011). *Technology Review of Urine Diversion Components. Overview of Urine Diversion Components Such as Waterless Urinals, Urine Diversion Toilets, Urine Storage and Reuse Systems*. Gesellschaft für Internationale Zusammenarbeit (GIZ) GmbH, Eschborn, DE. Available at: www.susana.org/library
- Richert, A., Gensch, R., Jönsson, H., Stenström, T. A., and Dagerskog, L. (2010). *Practical Guidance on the Use of Urine in Crop Production*. EcoSanRes, Stockholm Environment Institute, Stockholm, SE. Available at: www.susana.org/library
- WHO (2006). *Guidelines for the Safe Use of Wastewater, Excreta and Greywater. Volume 4: Excreta and Greywater Use in Agriculture*. World Health Organization, Geneva, CH. Available at: www.who.int (Health risks and recommended guidelines for urine application)

Application Level:	Management Level:	Inputs:  Dried Faeces
<input checked="" type="checkbox"/> Household	<input checked="" type="checkbox"/> Household	Outputs:  Biomass
<input checked="" type="checkbox"/> Neighbourhood	<input checked="" type="checkbox"/> Shared	
<input type="checkbox"/> City	<input checked="" type="checkbox"/> Public	

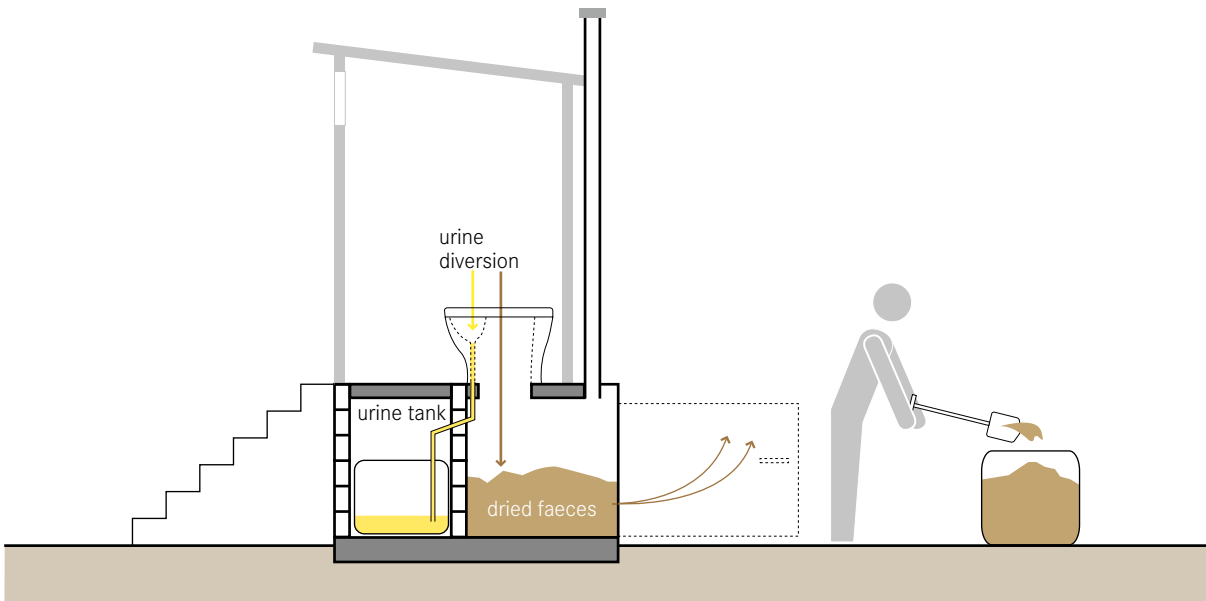

When faeces are stored in the absence of moisture (i.e., urine), they dehydrate into a crumbly, white-beige, coarse, flaky material or powder. The moisture naturally present in the faeces evaporates and/or is absorbed by the drying material (e.g., ash, sawdust, lime) that is added to them. Dried faeces can be used as a soil conditioner.

Dehydration is different from composting because the organic material present is not degraded or transformed; only the moisture is removed. Faeces will reduce in volume by about 75% after dehydration. Completely dry faeces are a crumbly, powdery substance. The shells and carcasses of worms and insects in the faeces also dehydrate and become part of the dried material. The material is rich in carbon and nutrients, but may still contain protozoan cysts or oocysts (spores that can survive extreme environmental conditions and be re-animated under favourable conditions) and other pathogens. The degree of pathogen inactivation will depend on the temperature, the pH (using ash or lime raises the pH) and storage time. It is generally accepted that faeces should be stored between 6 to 24 months, although pathogens may

still exist after this time (refer to WHO guidelines for specific guidance).

The material can be mixed into soil for agriculture (depending on acceptance) or safely mixed into soil or buried elsewhere. Extended storage is also an option if there is no immediate use for the material (see D.12).

Design Considerations Faeces that are dried and kept at between 2 and 20 °C should be stored for 1.5 to 2 years before being used at the household or regional level. At higher temperatures (i.e., >20 °C average), storage over 1 year is recommended to inactivate *Ascaris* eggs (a type of parasitic worm). A shorter storage time of 6 months is required if the faeces have a pH above 9 (i.e., adding ash or lime increases the pH). WHO guidelines concerning the use of excreta in agriculture should be consulted beforehand.

Appropriateness Dried faeces are not as useful as a soil amendment as composted faeces. However, they can help to replenish poor soil and to boost the carbon and water-storing properties of soil, while posing low risk of pathogen transmission.

Health Aspects/Acceptance The handling and use of dried faeces may not be acceptable to some people. However, because dehydrated faeces should be dry, crumbly, and odour free, using them might be easier to accept than manure or sludge. Dry faeces are a hostile environment for organisms and they do not survive long in it. If water or urine is mixed with the drying faeces, however, odours and organisms may become problematic because bacteria easily survive and multiply in wet faeces. Warm, moist environments are conducive to anaerobic processes, which can generate offensive odours.

Dehydrated faeces should not be applied to crops less than one month before they are harvested. This waiting period is especially important for crops that are consumed raw.

Operation & Maintenance When removing dehydrated faeces from dehydration vaults, care must be taken to prevent the powder from blowing and being inhaled. Workers should wear appropriate protective clothing.



Faeces should be kept as dry as possible. If by accident, water or urine enters and mixes with drying faeces, more ash, lime or dry soil should be added to help absorb the moisture. Prevention is the best way to keep faeces dry.

Pros & Cons

- + Can improve the structure and water-holding capacity of soil
- + Low risk of pathogen transmission
- + Low costs
- Labour intensive
- Pathogens may exist in a dormant stage (cysts and oocysts) which may become infectious if moisture is added
- Does not replace fertilizer (N, P, K)
- Social acceptance may be low in some areas

References & Further Reading

- _ Austin, A. and Duncker, L. (2002). *Urine-Diversion. Ecological Sanitation Systems in South Africa*. CSIR, Pretoria, ZA.
- _ Rieck, C., von Münch, E. and Hoffmann, H. (2012). *Technology Review of Urine-Diverting Dry Toilets (UDDTs). Overview of Design, Operation, Management and Costs*. Deutsche Gesellschaft für Internationale Zusammenarbeit (GIZ) GmbH, Eschborn, DE.
Available at: www.susana.org/library
- _ Schönning, C. and Stenström, T. A. (2004). *Guidelines for the Safe Use of Urine and Faeces in Ecological Sanitation Systems*. Report 2004-1. EcoSanRes, Stockholm Environment Institute, Stockholm, SE.
Available at: www.ecosanres.org
- _ WHO (2006). *Guidelines for the Safe Use of Wastewater, Excreta and Greywater. Volume 4: Excreta and Greywater Use in Agriculture*. World Health Organization, Geneva, CH.
Available at: www.who.int
- _ Winblad, U. and Simpson-Hébert, M. (Eds.) (2004). *Ecological Sanitation. Revised and Enlarged Edition*. Stockholm Environment Institute, Stockholm, SE.
Available at: www.ecosanres.org

Application Level: ★★ Household ★★ Neighbourhood ★ City	Management Level: ★★ Household ★★ Shared ★ Public	Inputs:  Pit Humus  Compost
		Outputs:  Biomass

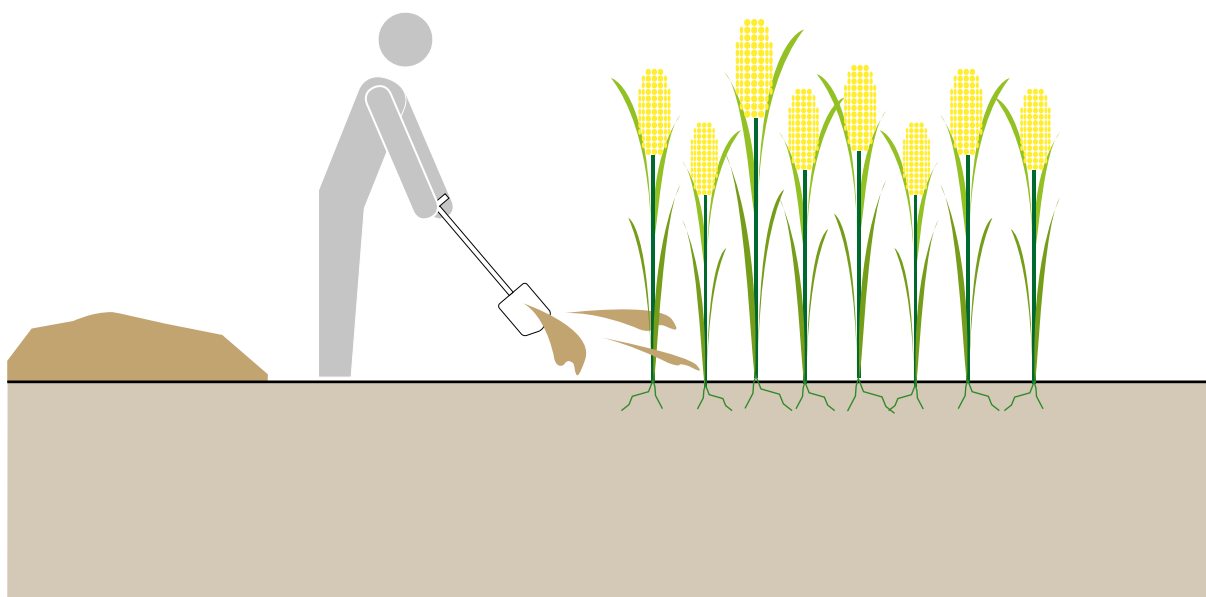

Compost is the soil-like substance resulting from the controlled aerobic degradation of organics. Pit humus is the term used to describe the material removed from a double pit technology (S.4, S.5 or S.6) because it is produced passively underground and has a slightly different composition than compost. Both products can be used as soil conditioners.

The process of thermophilic composting generates heat (50 to 80 °C) which kills the majority of pathogens present. The composting process requires adequate carbon, nitrogen, moisture, and air.

The Double VIP (S.4), Fossa Alterna (S.5) or Twin Pits for Pour Flush (S.6) are ambient-temperature variations of high-temperature composting. In these technologies, there is almost no increase in temperature because the conditions in the pit (oxygen, moisture, C:N ratio) are not optimized for composting processes to take place. Because of this, the material is not actually 'compost' and is, therefore, referred to as 'pit humus'. The texture and quality of the pit humus depends on the materials which have been added to the excreta (e.g., soil added to a Fossa Alterna) and the storage conditions.

WHO guidelines on excreta use in agriculture stipu-

late that compost should achieve and maintain a temperature of 50 °C for at least one week before it is considered safe to use. Achieving this value, however, requires a significantly longer period of composting. For technologies that generate pit humus, a minimum of 1 year of storage is recommended to eliminate bacterial pathogens and reduce viruses and parasitic protozoa. WHO guidelines should be consulted for detailed information.

Design Considerations It has been shown that the productivity of poor soil can be improved by applying equal parts compost and top soil to it. The output from one Fossa Alterna should be sufficient for two 1.5 m by 3.5 m beds.

Appropriateness Compost and pit humus can be beneficially used to improve the quality of soil. They add nutrients and organics and improve the soil's ability to store air and water. They can be mixed into the soil before crops are planted, used to start seedlings or indoor plants, or simply mixed into an existing compost pile for further treatment.

Vegetable gardens filled with pit humus from the Fos-

sa Alterna have shown dramatic improvements over gardens planted without soil conditioner. The use of pit humus has even made agriculture possible in areas which otherwise would not have supported crops.

Health Aspects/Acceptance A small risk of pathogen transmission exists, but, if in doubt, any material removed from the pit or vault can be further composted in a regular compost heap before being used or mixed with additional soil and put into a ‘tree pit’, i.e., a nutrient-filled pit used for planting a tree. Compost and pit humus should not be applied to crops less than one month before they are harvested. This waiting period is especially important for crops that are consumed raw.

As opposed to sludge, which can originate from a variety of domestic, chemical and industrial sources, compost and pit humus have very few chemical inputs. The only chemical sources that could contaminate compost or pit humus might originate from contaminated organic material (e.g., pesticides) or from chemicals that are excreted by humans (e.g., pharmaceutical residues). Compared to the chemicals that may find their way into wastewater sludge, compost and pit humus can be considered as less contaminated.

Compost and pit humus are inoffensive, earth-like products. Regardless, people might refrain from handling and using them. Conducting demonstration activities that promote hands-on experience can effectively show their non-offensive nature and their beneficial use.

Operation & Maintenance The material must be allowed to adequately mature before being removed from the system. Then, it can be used without further treatment. Workers should wear appropriate protective clothing.



Pros & Cons

- + Can improve the structure and water-holding capacity of soil and reduce the use of chemical fertilizers
- + May encourage income generation (improved yield and productivity of plants)
- + Low risk of pathogen transmission
- + Low costs

- May require a year or more of maturation
- Social acceptance may be low in some areas

References & Further Reading

- Del Porto, D. and Steinfeld, C. (1999). *The Composting Toilet System Book. A Practical Guide to Choosing, Planning and Maintaining Composting Toilet Systems, an Alternative to Sewer and Septic Systems*. The Center for Ecological Pollution Prevention (CEPP), Concord, MA, US.
- Jenkins, J. (2005). *The Humanure Handbook. A Guide to Composting Human Manure*. 3rd Ed. Jenkins Publishing, Grove City, PA, US.
- Morgan, P. R. (2004). *An Ecological Approach to Sanitation in Africa. A Compilation of Experiences*. Aquamor, Harare, ZW. Available at: www.ecosanres.org
- Morgan, P. R. (2007). *Toilets That Make Compost. Low-Cost, Sanitary Toilets That Produce Valuable Compost for Crops in an African Context*. Stockholm Environment Institute, Stockholm, SE. pp. 81-90. Available at: www.ecosanres.org
- Morgan, P. R. (2009). *Ecological Toilets. Start Simple and Upgrade from Arborloo to VIP*. Stockholm Environment Institute, Stockholm, SE. Available at: www.ecosanres.org
- NWP (2006). *Smart Sanitation Solutions. Examples of Innovative, Low-Cost Technologies for Toilets, Collection, Transportation, Treatment and Use of Sanitation Products*. Netherlands Water Partnership, The Hague, NL. Available at: www.ircwash.org
- Strande, L., Ronteltap, M. and Brdjanovic, D. (Eds.) (2014). *Faecal Sludge Management. Systems Approach for Implementation and Operation*. IWA Publishing, London, UK. Available at: www.sandec.ch (Detailed book compiling the current state of knowledge on all aspects related to FSM)
- WHO (2006). *Guidelines for the Safe Use of Wastewater, Excreta and Greywater. Volume 4: Excreta and Greywater Use in Agriculture*. World Health Organization, Geneva, CH. Available at: www.who.int

Application Level: <input type="checkbox"/> Household <input checked="" type="checkbox"/> Neighbourhood <input checked="" type="checkbox"/> City	Management Level: <input checked="" type="checkbox"/> Household <input checked="" type="checkbox"/> Shared <input checked="" type="checkbox"/> Public	Inputs:  Sludge
		Outputs:  Biomass

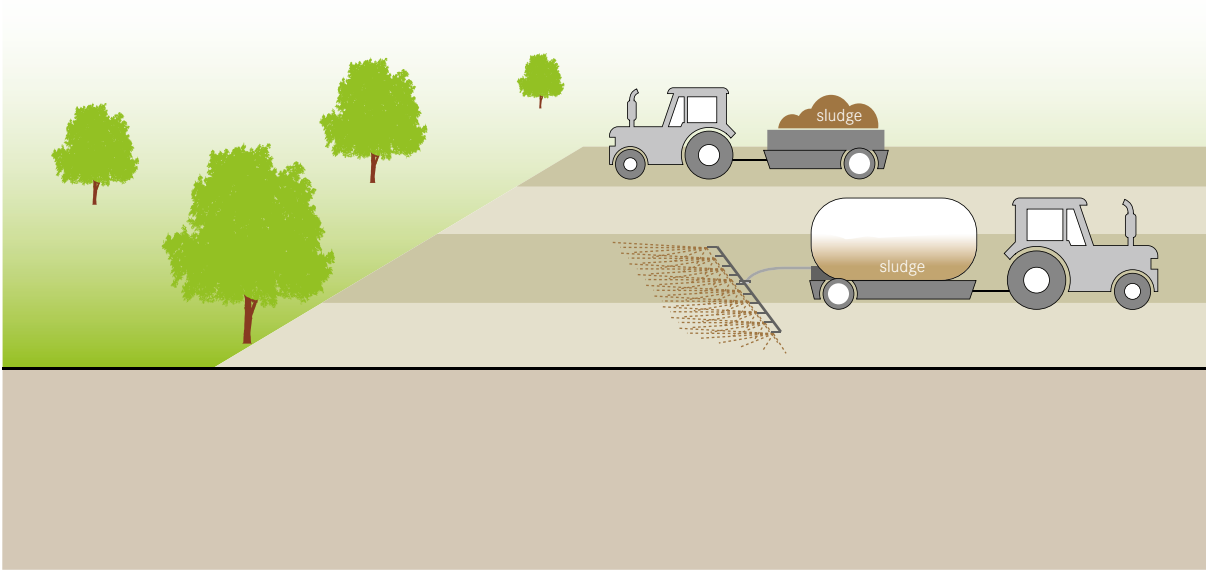

Depending on the treatment type and quality, digested or stabilized sludge can be applied to public or private lands for landscaping or agriculture.

Sludge that has been treated (e.g., Co-Composted or removed from a Planted Drying Bed, etc.) can be used in agriculture, home gardening, forestry, sod and turf growing, landscaping, parks, golf courses, mine reclamation, as a dump cover, or for erosion control. Although sludge has lower nutrient levels than commercial fertilizers (for nitrogen, phosphorus and potassium, respectively), it can replace an important part of the fertilizer need. Additionally, treated sludge has been found to have properties superior to those of fertilizers, such as bulking and water retention properties, and the slow, steady release of nutrients.

Design Considerations Solids are spread on the ground surface using conventional manure spreaders, tank trucks or specially designed vehicles. Liquid sludge (e.g., from anaerobic reactors) can be sprayed onto or injected into the ground.

Application rates and usage of sludge should take into account the presence of pathogens and contaminants,

and the quantity of nutrients available so that it is used at a sustainable and agronomic rate.

Appropriateness Although sludge is sometimes criticized for containing potentially high levels of metals or contaminants, commercial fertilizers are also contaminated to varying degrees, most likely with cadmium or other heavy metals. Faecal sludge from pit latrines should not have any chemical inputs and is, therefore, not a high-risk source of heavy metal contamination. Sludge that originates at large-scale wastewater treatment plants is more likely to be contaminated since it receives industrial and domestic chemicals, as well as surface water run-off which may contain hydrocarbons and metals. Depending on the source, sludge can serve as a valuable and often much-needed source of nutrients. Application of sludge on land may be less expensive than disposal.

Health Aspects/Acceptance The greatest barrier to the use of sludge is, generally, acceptance. However, even when sludge is not accepted by agriculture or local industries, it can still be useful for municipal projects and can actually provide significant savings (e.g., mine reclamation).

Depending on the source of the sludge and on the treatment method, it can be treated to a level where it is generally safe and no longer generates significant odour or vector problems. Following appropriate safety and application regulations is important. WHO guidelines on excreta use in agriculture should be consulted for detailed information.





Operation & Maintenance Spreading equipment must be maintained to ensure continued use. The amount and rate of sludge application should be monitored to prevent overloading and, thus, the potential for nutrient pollution. Workers should wear appropriate protective clothing.

Pros & Cons

- + Can reduce the use of chemical fertilizers and improve the water-holding capacity of soil
- + Can accelerate reforestation
- + Can reduce erosion
- + Low costs
- Odours may be noticeable, depending on prior treatment
- May require special spreading equipment
- May pose public health risks, depending on its quality and application
- Micropollutants may accumulate in the soil and contaminate groundwater
- Social acceptance may be low in some areas

References & Further Reading

- Strande, L., Ronteltap, M. and Brdjanovic, D. (Eds.) (2014). *Faecal Sludge Management. Systems Approach for Implementation and Operation*. IWA Publishing, London, UK. Available at: www.sandec.ch (Detailed book compiling the current state of knowledge on all aspects related to FSM)
- U.S. EPA (1999). *Biosolids Generation, Use, and Disposal in the United States*. EPA-530/R-99-009. U.S. Environmental Protection Agency, Washington, D.C., US. Available at: www.epa.gov
- U.S. EPA (1994). *A Plain English Guide to the EPA Part 503 Biosolids Rule*. EPA832-R-93-003. U.S. Environmental Protection Agency, Washington, D.C., US. Available at: www.epa.gov
- WHO (2006). *Guidelines for the Safe Use of Wastewater, Excreta and Greywater. Volume 4: Excreta and Greywater Use in Agriculture*. World Health Organization, Geneva, CH. Available at: www.who.int

Application Level: ★★ Household ★★ Neighbourhood ★★ City	Management Level: ★★ Household ★★ Shared ★★ Public	Inputs:  Effluent  Stormwater (+  Stored Urine)
		Outputs:  Biomass

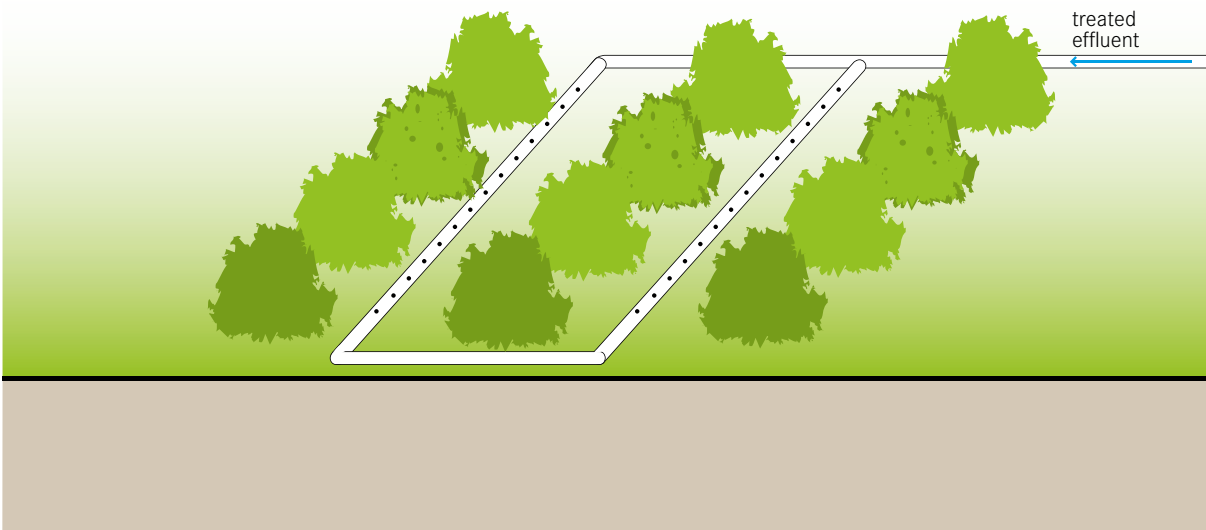

To reduce dependence on freshwater and maintain a constant source of water for irrigation throughout the year, wastewater of varying quality can be used in agriculture. However, only water that has had secondary treatment (i.e., physical and biological treatment) should be used to limit the risk of crop contamination and health risks to workers.

There are two kinds of irrigation technologies appropriate for treated wastewater:

- 1) Drip irrigation above or below ground, where the water is slowly dripped on or near the root area; and
- 2) Surface water irrigation where water is routed overland in a series of dug channels or furrows.

To minimize evaporation and contact with pathogens, spray irrigation should be avoided.

Properly treated wastewater can significantly reduce dependence on fresh water, and/or improve crop yields by supplying increased water and nutrients to plants. Raw sewage or untreated blackwater should not be used, and even well-treated water should be used with caution. Long-term use of poorly or improperly treated water may cause long-term damage to the soil structure and its ability to hold water.

Design Considerations The application rate must be appropriate for the soil, crop and climate, or it could be damaging. To increase the nutrient value, urine can be dosed into irrigation water; this is called “fertigation” (i.e., fertilization + irrigation). The dilution ratio has to be adapted to the special needs and resistance of the crop. In drip irrigation systems care should be taken to ensure that there is sufficient head (i.e., pressure) and maintenance to reduce the potential for clogging (especially, with urine from which struvite will spontaneously precipitate).

Appropriateness Generally, drip irrigation is the most appropriate irrigation method; it is especially good for arid and drought prone areas. Surface irrigation is prone to large losses from evaporation but requires little or no infrastructure and may be appropriate in some situations.

Crops such as corn, alfalfa (and other feed), fibres (e.g., cotton), trees, tobacco, fruit trees (e.g., mangos) and foods requiring processing (e.g., sugar beets) can be grown safely with treated effluent. More care should be taken with fruits and vegetables that may be eaten raw (e.g., tomatoes) because they could come in contact

with the water. Energy crops like eucalyptus, poplar, willow, or ash trees can be grown in short-rotation and harvested for biofuel production. Since the trees are not for consumption, this is a safe, efficient way of using lower-quality effluent.

Soil quality can degrade over time (e.g., due to the accumulation of salts) if poorly treated wastewater is applied. Despite safety concerns, irrigation with effluent is an effective way to recycle nutrients and water.

Health Aspects/Acceptance Appropriate treatment (i.e., adequate pathogen reduction) should precede any irrigation scheme to limit health risks to those who come in contact with the water. Furthermore, it may still be contaminated with the different chemicals that are discharged into the system depending on the degree of treatment the effluent has undergone. When effluent is used for irrigation, households and industries connected to the system should be made aware of the products that are and are not appropriate to discharge into the system. Drip irrigation is the only type of irrigation that should be used with edible crops, and even then, care should be taken to prevent workers and harvested crops from coming in contact with the treated effluent. The WHO guidelines on wastewater use in agriculture should be consulted for detailed information and specific guidance.

Operation & Maintenance Drip irrigation systems must be periodically flushed to avoid biofilm growth and clogging from all types of solids. Pipes should be checked for leaks as they are prone to damage from rodents and humans. Drip irrigation is more costly than conventional irrigation, but offers improved yields and decreased water/operating costs. Workers should wear appropriate protective clothing.

Pros & Cons

- + Reduces depletion of groundwater and improves the availability of drinking water
- + Reduces the need for fertilizer
- + Potential for local job creation and income generation
- + Low risk of pathogen transmission if water is properly treated

- + Low capital and operating costs depending on the design
- May require expert design and installation
- Not all parts and materials may be locally available
- Drip irrigation is very sensitive to clogging, i.e., the water must be free from suspended solids
- Risk of soil salinization if the soil is prone to the accumulation of salts
- Social acceptance may be low in some areas

References & Further Reading

- Drechsel, P., Scott, C. A., Raschid-Sally, L., Redwood, M. and Bahri, A. (Eds.) (2010). *Wastewater Irrigation and Health. Assessing and Mitigating Risk in Low-Income Countries*. Earthscan, IDRC and IWMI, London, UK. Available at: www.idrc.ca and www.iwmi.cgiar.org
- FAO (2012). *On-Farm Practices for the Safe Use of Wastewater in Urban and Peri-Urban Horticulture. A Training Handbook for Farmer Field Schools*. FAO, Rome, IT. Available at: www.fao.org
- Palada, M., Bhattarai, S., Wu, D., Roberts, M., Bhattarai, M., Kimsan, R. and Midmore, D. (2011). *More Crop Per Drop. Using Simple Drip Irrigation Systems for Small-Scale Vegetable Production*. The World Vegetable Center, Shanhua, TW. Available at: www.avrdc.org
- Pescod, M. B. (1992). *Wastewater Treatment and Use in Agriculture*. FAO Irrigation and Drainage Paper 47. FAO, Rome, IT. Available at: www.fao.org
- WHO (2006). *Guidelines for the Safe Use of Wastewater, Excreta and Greywater. Volume 2: Wastewater Use in Agriculture*. World Health Organization, Geneva, CH. Available at: www.who.int (Discussion of health aspects of wastewater use and of good irrigation practice in Annex 1)
- Winpenny, J., Heinz, I. and Koo-Oshima, S. (2010). *The Wealth of Waste. The Economics of Wastewater Use in Agriculture*. FAO Water Reports 35. FAO, Rome, IT. Available at: www.fao.org
- Zandee, M. (2012). *Risk of Clogging of Drip-Line Emitters during Urine Fertilization through Drip Irrigation Equipment*. Eawag, Dübendorf, CH. Available at: www.eawag.ch/stun

Application Level:

- Household
- Neighbourhood
- City

Management Level:

- Household
- Shared
- Public

Inputs: Effluent Greywater Urine
 Stored Urine Anal Cleansing Water

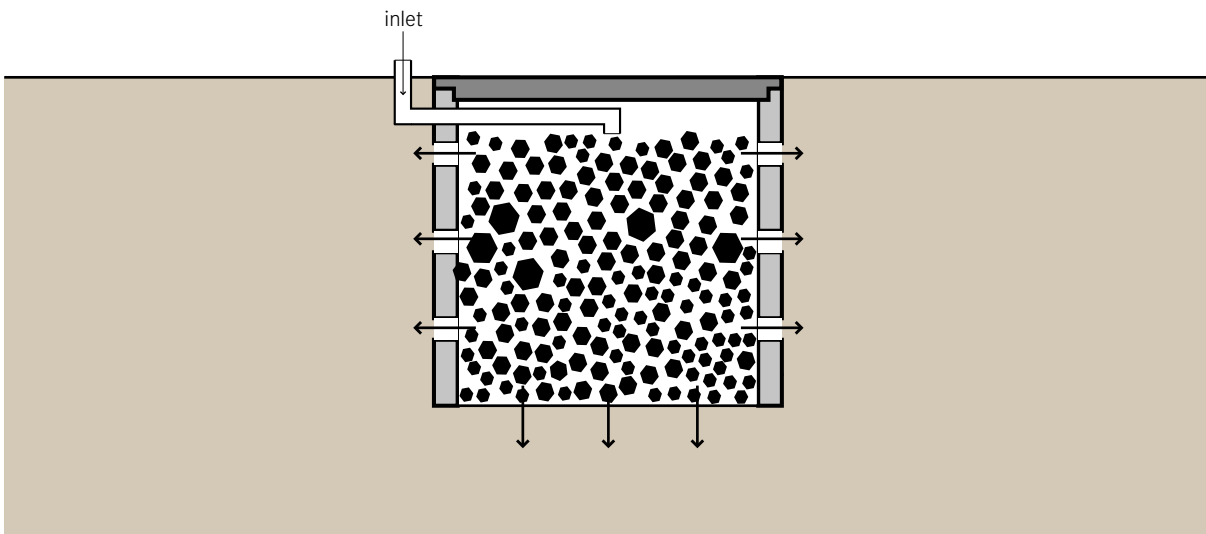

A soak pit, also known as a soakaway or leach pit, is a covered, porous-walled chamber that allows water to slowly soak into the ground. Pre-settled effluent from a Collection and Storage/Treatment or (Semi-) Centralized Treatment technology is discharged to the underground chamber from which it infiltrates into the surrounding soil.

As wastewater (greywater or blackwater after primary treatment) percolates through the soil from the soak pit, small particles are filtered out by the soil matrix and organics are digested by microorganisms. Thus, soak pits are best suited for soil with good absorptive properties; clay, hard packed or rocky soil is not appropriate.

Design Considerations The soak pit should be between 1.5 and 4 m deep, but as a rule of thumb, never less than 2 m above the groundwater table. It should be located at a safe distance from a drinking water source (ideally more than 30 m). The soak pit should be kept away from high-traffic areas so that the soil above and around it is not compacted. It can be left empty and lined with a porous material to provide support and pre-

vent collapse, or left unlined and filled with coarse rocks and gravel. The rocks and gravel will prevent the walls from collapsing, but will still provide adequate space for the wastewater. In both cases, a layer of sand and fine gravel should be spread across the bottom to help disperse the flow. To allow for future access, a removable (preferably concrete) lid should be used to seal the pit until it needs to be maintained.

Appropriateness A soak pit does not provide adequate treatment for raw wastewater and the pit will quickly clog. It should be used for discharging pre-settled blackwater or greywater.

Soak pits are appropriate for rural and peri-urban settlements. They depend on soil with a sufficient absorptive capacity. They are not appropriate for areas prone to flooding or that have high groundwater tables.

Health Aspects/Acceptance As long as the soak pit is not used for raw sewage, and as long as the previous Collection and Storage/Treatment technology is functioning well, health concerns are minimal. The technology is located underground and, thus, humans and animals should have no contact with the effluent.

Since the soak pit is odourless and not visible, it should be accepted by even the most sensitive communities.

Operation & Maintenance A well-sized soak pit should last between 3 and 5 years without maintenance. To extend the life of a soak pit, care should be taken to ensure that the effluent has been clarified and/or filtered to prevent the excessive build-up of solids. Particles and biomass will eventually clog the pit and it will need to be cleaned or moved. When the performance of the soak pit deteriorates, the material inside the soak pit can be excavated and refilled.

Pros & Cons

- + Can be built and repaired with locally available materials
- + Technique simple to apply for all users
- + Small land area required
- + Low capital and operating costs
- Primary treatment is required to prevent clogging
- May negatively affect soil and groundwater properties

References & Further Reading

- _ Ahrens, B. (2005). *A Comparison of Wash Area and Soak Pit Construction: The Changing Nature of Urban, Rural, and Peri-Urban Linkages in Sikasso, Mali*. Peace Corps, US. Available at: www.mtu.edu/peacecorps/programs/civil/theses
(Detailed construction instructions)
- _ Mara, D. D. (1996). *Low-Cost Urban Sanitation*. Wiley, Chichester, UK. pp. 63-65.
(Dimensioning calculations)
- _ Oxfam (2008). *Septic Tank Guidelines*. Technical Brief. Oxfam GB, Oxford, UK. p. 4.
Available at: policy-practice.oxfam.org.uk
- _ Polprasert, C. and Rajput, V. S. (1982). *Environmental Sanitation Reviews. Septic Tank and Septic Systems*. Environmental Sanitation Information Center, AIT, Bangkok, TH. pp. 31-58.

Application Level:

- Household
 Neighbourhood
 City

Management Level:

- Household
 Shared
 Public

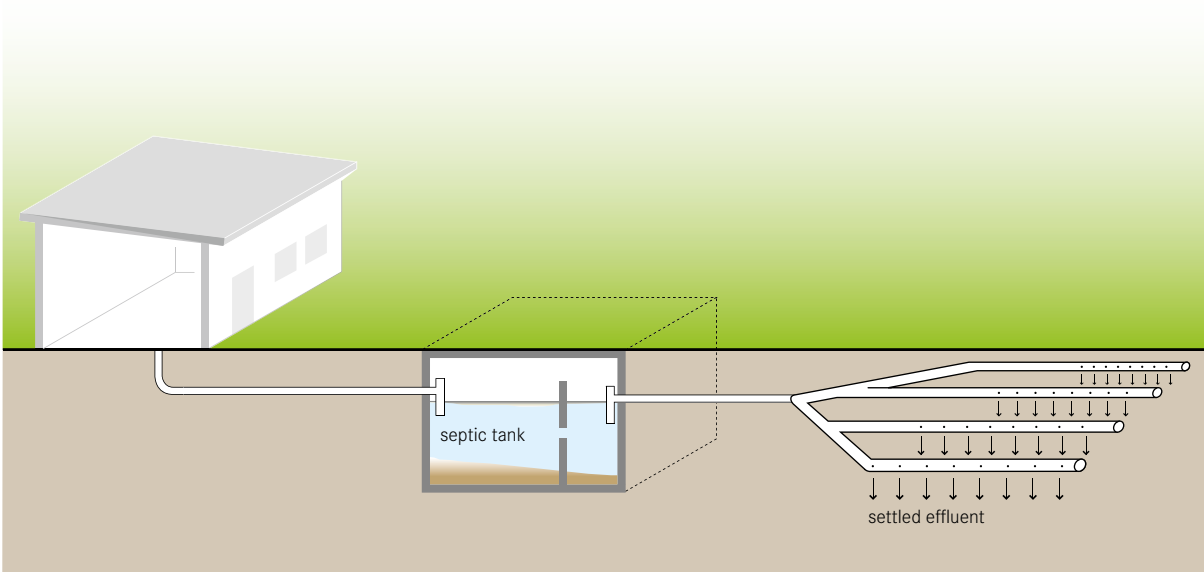
Inputs: Effluent

A leach field, or drainage field, is a network of perforated pipes that are laid in underground gravel-filled trenches to dissipate the effluent from a water-based Collection and Storage/Treatment or (Semi-) Centralized Treatment technology.

Pre-settled effluent is fed into a piping system (distribution box and several parallel channels) that distributes the flow into the subsurface soil for absorption and subsequent treatment. A dosing or pressurized distribution system may be installed to ensure that the whole length of the leach field is utilized and that aerobic conditions are allowed to recover between dosings. Such a dosing system releases the pressurized effluent into the leach field with a timer (usually 3 to 4 times a day).

Design Considerations Each trench is 0.3 to 1.5 m deep and 0.3 to 1 m wide. The bottom of each trench is filled with about 15 cm of clean rock and a perforated distribution pipe is laid on top. More rock is placed to cover the pipe. A layer of geotextile fabric is placed on the rock layer to prevent small particles from plugging the pipe. A final layer of sand and/or topsoil covers the fabric and fills the trench to the ground level. The pipe

should be placed at least 15 cm beneath the surface to prevent effluent from surfacing. The trenches should be dug no longer than 20 m in length and at least 1 to 2 m apart. To prevent contamination, a leach field should be located at least 30 m away from any drinking water source. A leach field should be laid out such that it will not interfere with a future sewer connection. The collection technology which precedes the leach field (e.g., Septic Tank, S.9) should be equipped with a sewer connection so that if, or when, the leach field needs to be replaced, the changeover can be done with minimal disruption.

Appropriateness Leach fields require a large area and unsaturated soil with good absorptive capacity to effectively dissipate the effluent. Due to potential oversaturation of the soil, leach fields are not appropriate for dense urban areas. They can be used in almost every temperature, although there may be problems with pooling effluent in areas where the ground freezes. Homeowners who have a leach field must be aware of how it works and of their maintenance responsibilities. Trees and deep-rooted plants should be kept away from the leach field as they can crack and disturb the tile bed.

Health Aspects/Acceptance Since the technology is underground and requires little attention, users will rarely come in contact with the effluent and, therefore, it has no health risk. The leach field must be kept as far away as possible (at least 30 m) from any potential potable water source to avoid contamination.

Operation & Maintenance A leach field will become clogged over time, although this may take 20 or more years, if a well-maintained and well-functioning primary treatment technology is in place. Effectively, a leach field should require minimal maintenance; however, if the system stops working efficiently, the pipes should be cleaned and/or removed and replaced. To maintain the leach field, there should be no plants or trees on it. There should also be no heavy traffic above it because this could crush the pipes or compact the soil.

Pros & Cons

- + Can be used for the combined treatment and disposal of effluent
- + Has a long lifespan (depending on conditions)
- + Low maintenance requirements if operating without mechanical equipment
- + Relatively low capital costs; low operating costs
- Requires expert design and construction
- Not all parts and materials may be locally available
- Requires a large area
- Primary treatment is required to prevent clogging
- May negatively affect soil and groundwater properties

References & Further Reading

- Crites, R. and Tchobanoglous, G. (1998). *Small and Decentralized Wastewater Management Systems*. WCB/McGraw-Hill, New York, US. pp. 905-927.
- Morel, A. and Diener, S. (2006). *Greywater Management in Low and Middle-Income Countries. Review of Different Treatment Systems for Households or Neighbourhoods*. Eawag (Department Sandec), Dübendorf, CH. Available at: www.sandec.ch
- Polprasert, C. and Rajput, V. S. (1982). *Environmental Sanitation Reviews: Septic Tank and Septic Systems*. Environmental Sanitation Information Center, AIT, Bangkok, TH.
- U.S. EPA (1980). *Design Manual. Onsite Wastewater Treatment and Disposal Systems*. EPA 625/1-80-012. U.S. Environmental Protection Agency, Cincinnati, OH, US. Available at: www.epa.gov

Application Level: <input type="checkbox"/> Household <input checked="" type="checkbox"/> Neighbourhood <input checked="" type="checkbox"/> City	Management Level: <input type="checkbox"/> Household <input checked="" type="checkbox"/> Shared <input checked="" type="checkbox"/> Public	Inputs: <input checked="" type="checkbox"/> Effluent
		Outputs: <input checked="" type="checkbox"/> Biomass

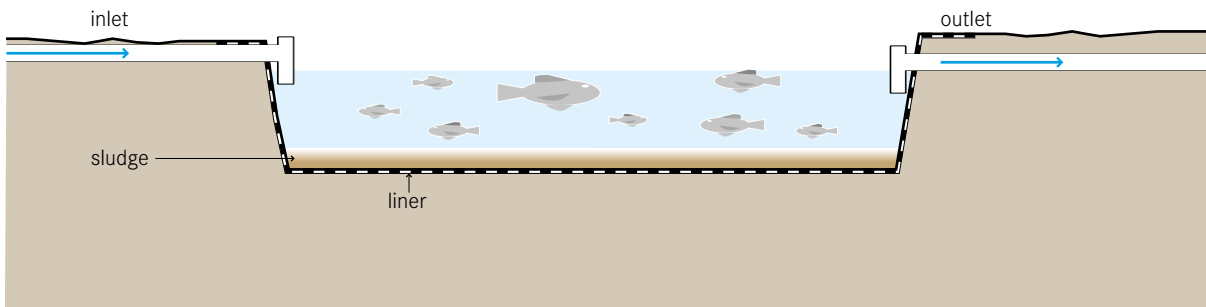

Fish can be grown in ponds that receive effluent or sludge where they can feed on algae and other organisms that grow in the nutrient-rich water. The fish, thereby, remove the nutrients from the wastewater and are eventually harvested for consumption.

Three kinds of aquaculture designs for raising fish exist:

- 1) fertilization of fish ponds with effluent;
- 2) fertilization of fish ponds with excreta/sludge; and
- 3) fish grown directly in aerobic ponds (T.5 or T.6).

Fish introduced into aerobic ponds can effectively reduce algae and help control the mosquito population. It is also possible to combine fish and floating plants (D.10) in one single pond. The fish themselves do not dramatically improve the water quality, but because of their economic value they can offset the costs of operating a treatment facility. Under ideal operating conditions, up to 10,000 kg/ha of fish can be harvested. If the fish are not acceptable for human consumption, they can be a valuable source of protein for other high-value carnivores (like shrimp) or converted into fishmeal for pigs and chickens.

Design Considerations The design should be based on the quantity of nutrients to be removed, the nutrients required by the fish and the water requirements needed to ensure healthy living conditions (e.g., low ammonium levels, required water temperature, etc.). When introducing nutrients in the form of effluent or sludge, it is important to limit the additions so that aerobic conditions are maintained. BOD should not exceed 1 g/m²/d and oxygen should be at least 4 mg/L.

Only fish tolerant of low dissolved oxygen levels should be chosen. They should not be carnivores and they should be tolerant to diseases and adverse environmental conditions. Different varieties of carp, milkfish and tilapia have been successfully used, but the specific choice will depend on local preference and suitability.

Appropriateness A fish pond is only appropriate where there is a sufficient amount of land (or pre-existing pond), a source of fresh water and a suitable climate. The water used to dilute the waste should not be too warm, and the ammonium levels should be kept low or negligible because of its toxicity to fish.

This technology is appropriate for warm or tropical cli-

mates with no freezing temperatures, and preferably with high rainfall and minimal evaporation.

Health Aspects/Acceptance Where there is no other source of readily available protein, this technology may be embraced. The quality and condition of the fish will also influence local acceptance. There may be concern about contamination of the fish, especially when they are harvested, cleaned and prepared. If they are cooked well, they should be safe, but it is advisable to move the fish to a clear-water pond for several weeks before they are harvested for consumption. WHO guidelines on wastewater and excreta use in aquaculture should be consulted for detailed information and specific guidance.

Operation & Maintenance The fish need to be harvested when they reach an appropriate age/size. Sometimes after harvesting, the pond should be drained so that (a) it can be desludged and (b) it can be left to dry in the sun for 1 to 2 weeks to destroy any pathogens living on the bottom or sides of the pond. Workers should wear appropriate protective clothing.

Pros & Cons

- + Can provide a cheap, locally available protein source
- + Potential for local job creation and income generation
- + Relatively low capital costs; operating costs should be offset by production revenue
- + Can be built and maintained with locally available materials
- Requires abundance of fresh water
- Requires a large land (pond) area
- May require expert design and installation
- Fish may pose a health risk if improperly prepared or cooked
- Social acceptance may be low in some areas

References & Further Reading

- _ Cross, P. and Strauss, M. (1985). *Health Aspects of Nightsoil and Sludge Use in Agriculture and Aquaculture*. International Reference Centre for Waste Disposal, Dübendorf, CH.
- _ Edwards, P. and Pullin, R. S. V. (Eds.) (1990). *Wastewater-Fed Aquaculture*. Proceedings: International Seminar on Wastewater Reclamation and Reuse for Aquaculture, Calcutta, IN.
(Compilation of topical papers)
- _ Iqbal, S. (1999). *Duckweed Aquaculture. Potentials, Possibilities and Limitations for Combined Wastewater Treatment and Animal Feed Production in Developing Countries*. Eawag (Department Sandec), Dübendorf, CH.
Available at: www.sandec.ch
- _ Johnson Cointreau, S. (1987). *Aquaculture with Treated Wastewater: A Status Report on Studies Conducted in Lima, Peru*. Technical Note No. 3, Integrated Resource Recovery Project. The World Bank, Washington, D.C., US. 1987.
Available at: documents.worldbank.org/curated/en/home
- _ Joint FAO/NACA/WHO Study Group (1999). *Food Safety Issues Associated with Products from Aquaculture*. WHO Technical Report Series 883. World Health Organization, Geneva, CH.
Available at: www.who.int
- _ Mara, D. D. (2003). *Domestic Wastewater Treatment in Developing Countries*. Earthscan, London, UK. pp. 253-261.
- _ Rose, G. D. (1999). *Community-Based Technologies for Domestic Wastewater Treatment and Reuse: Options for Urban Agriculture*. International Development Research Centre (IDRC), Ottawa, CA.
Available at: www.sswm.info/library
- _ WHO (2006). *Guidelines for the Safe Use of Wastewater, Excreta and Greywater. Volume 3: Wastewater and Excreta Use in Aquaculture*. World Health Organization, Geneva, CH.
Available at: www.who.int

Application Level: <input type="checkbox"/> Household <input checked="" type="checkbox"/> Neighbourhood <input checked="" type="checkbox"/> City	Management Level: <input type="checkbox"/> Household <input checked="" type="checkbox"/> Shared <input checked="" type="checkbox"/> Public	Inputs: <input checked="" type="checkbox"/> Effluent
		Outputs: <input checked="" type="checkbox"/> Biomass

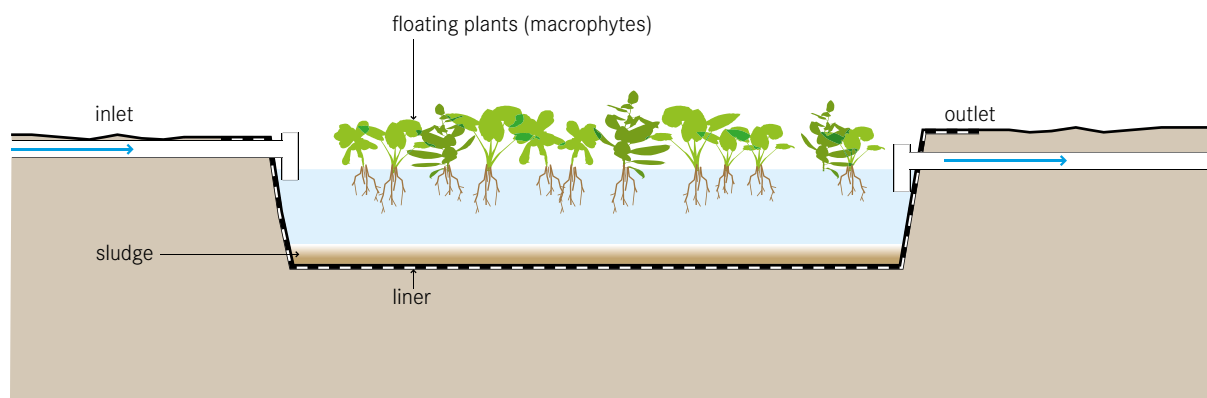

A floating plant pond is a modified maturation pond with floating (macrophyte) plants. Plants such as water hyacinths or duckweed float on the surface while the roots hang down into the water to uptake nutrients and filter the water that flows by.

Water hyacinths are perennial, freshwater, aquatic macrophytes that grow especially fast in wastewater. The plants can grow large: between 0.5 to 1.2 m from top to bottom. The long roots provide a fixed medium for bacteria which in turn degrade the organics in the water passing by.

Duckweed is a fast growing, high protein plant that can be used fresh or dried as a food for fish or poultry. It is tolerant of a variety of conditions and can significantly remove quantities of nutrients from wastewater.

Design Considerations Locally appropriate plants can be selected depending on their availability and the characteristics of the wastewater.

To provide extra oxygen to a floating plant technology, the water can be mechanically aerated but at the cost of increased power and machinery. Aerated ponds can withstand higher loads and can be built with smaller

footprints. Non-aerated ponds should not be too deep otherwise there will be insufficient contact between the bacteria-harboring roots and the wastewater.

Appropriateness A floating plant pond is only appropriate when there is a sufficient amount of land (or pre-existing pond). It is appropriate for warm or tropical climates with no freezing temperatures, and preferably with high rainfall and minimal evaporation. The technology can achieve high removal rates of both BOD and suspended solids, although pathogen removal is not substantial.

Harvested hyacinths can be used as a source of fibre for rope, textiles, baskets, etc. Depending on the income generated, the technology can be cost neutral. Duckweed can be used as the sole food source for some herbivorous fish.

Health Aspects/Acceptance Water hyacinth has attractive, lavender flowers. A well designed and maintained system can add value and interest to otherwise barren land.

Adequate signage and fencing should be used to prevent people and animals from coming in contact with

the water. Workers should wear appropriate protective clothing. WHO guidelines on wastewater and excreta use in aquaculture should be consulted for detailed information and specific guidance.



Operation & Maintenance Floating plants require constant harvesting. The harvested biomass can be used for small artisanal businesses, or it can be composted. Mosquito problems can develop when the plants are not regularly harvested. Depending on the amount of solids that enter the pond, it must be periodically desludged. Trained staff is required to constantly operate and maintain it.

Pros & Cons

- + Water hyacinth grows rapidly and is attractive
- + Potential for local job creation and income generation
- + Relatively low capital costs; operating costs can be offset by revenue
- + High reduction of BOD and solids; low reduction of pathogens
- + Can be built and maintained with locally available materials
- Requires a large land (pond) area
- Some plants can become invasive species if released into natural environments

References & Further Reading

- _ Crites, R. and Tchobanoglous, G. (1998). *Small and Decentralized Wastewater Management Systems*. WCB/McGraw-Hill, New York, US. pp. 609-627.
(Comprehensive summary chapter including solved problems)
- _ Iqbal, S. (1999). *Duckweed Aquaculture. Potentials, Possibilities and Limitations for Combined Wastewater Treatment and Animal Feed Production in Developing Countries*. Eawag (Department Sandec), Dübendorf, CH.
Available at: www.sandec.ch
- _ McDonald, R. D. and Wolverton, B. C. (1980). *Comparative Study of Wastewater Lagoon with and without Water Hyacinth*. *Economic Botany* 34 (2): 101-110.
- _ Reddy, K. R. and Smith, W. H. (Eds.) (1987). *Aquatic Plants for Water Treatment and Resource Recovery*. Magnolia Publishing Inc., Orlando, FL, US.
- _ Skillicorn, P., Spira, W. and Journey, W. (1993). *Duckweed Aquaculture. A New Aquatic Farming System for Developing Countries*. The World Bank, Washington, D.C., US.
Available at: documents.worldbank.org/curated/en/home
(Comprehensive manual)
- _ U.S. EPA (1988). *Design Manual. Constructed Wetlands and Aquatic Plant Systems for Municipal Water Treatment*. EPA/625/1-88/022. U.S. Environmental Protection Agency, Cincinnati, OH, US.
Available at: www.epa.gov
- _ WHO (2006). *Guidelines for the Safe Use of Wastewater, Excreta and Greywater. Volume 3: Wastewater and Excreta Use in Aquaculture*. World Health Organization, Geneva, CH.
Available at: www.who.int

Application Level:	Management Level:	Inputs:  Effluent  Stormwater
<ul style="list-style-type: none">  Household  Neighbourhood  City 	<ul style="list-style-type: none">  Household  Shared  Public 	

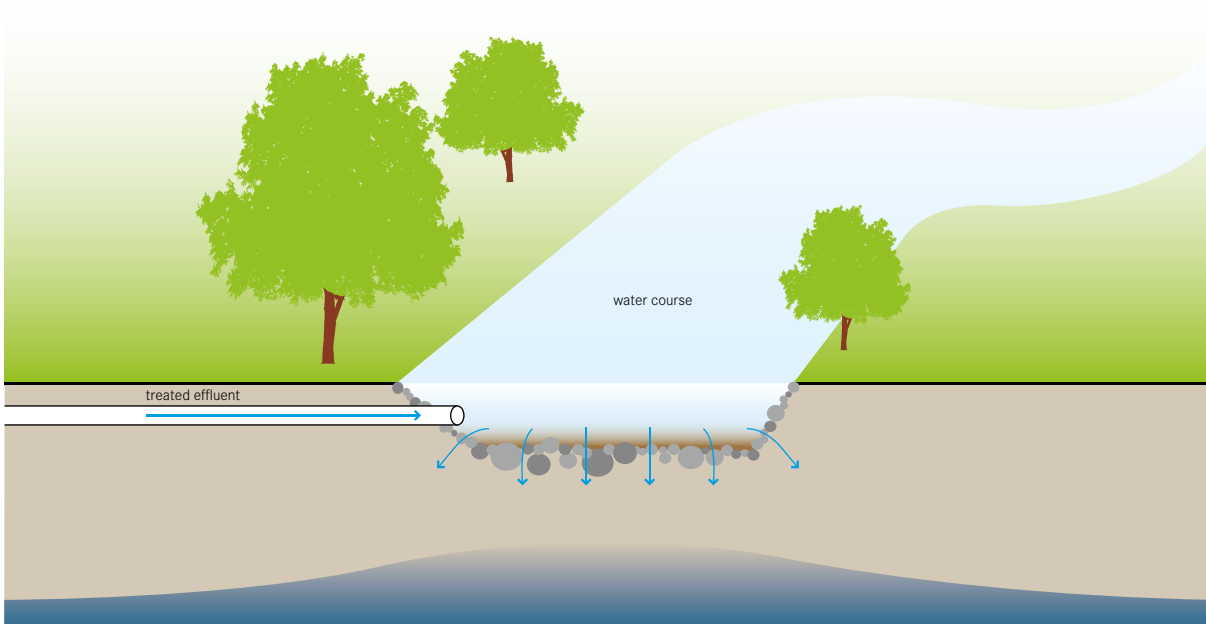

Treated effluent and/or stormwater can be directly discharged into receiving water bodies (such as rivers, lakes, etc.) or into the ground to recharge aquifers.

The use of the surface water body, whether it is for industry, recreation, spawning habitat, etc., will influence the quality and quantity of treated wastewater that can be introduced without deleterious effects.

Alternatively, water can be discharged into aquifers. Groundwater recharge is increasing in popularity as groundwater resources deplete and as saltwater intrusion becomes a greater threat to coastal communities. Although the soil is known to act as a filter for a variety of contaminants, groundwater recharge should not be viewed as a treatment method. Once an aquifer is contaminated, it is next to impossible to reclaim it.

Design Considerations It is necessary to ensure that the assimilation capacity of the receiving water body is not exceeded, i.e. that the receiving body can accept the quantity of nutrients without being overloaded. Parameters such as turbidity, temperature, suspended solids, BOD, nitrogen and phosphorus (among

others) should be carefully controlled and monitored before releasing any water into a natural body. Local authorities should be consulted to determine the discharge limits for the relevant parameters as they can widely vary. For especially sensitive areas, a post-treatment technology (e.g., chlorination, see POST, p. 136) may be required to meet microbiological limits.

The quality of water extracted from a recharged aquifer is a function of the quality of the wastewater introduced, the method of recharge, the characteristics of the aquifer, the residence time, the amount of blending with other waters and the history of the system. Careful analysis of these factors should precede any recharge project.

Appropriateness The adequacy of discharge into a water body or aquifer will entirely depend on the local environmental conditions and legal regulations. Generally, discharge to a water body is only appropriate when there is a safe distance between the discharge point and the next closest point of use. Similarly, groundwater recharge is most appropriate for areas that are at risk of saltwater intrusion or aquifers that have a long retention time.

Depending on the volume, the point of discharge and/or the quality of the water, a permit may be required.

Health Aspects/Acceptance Generally, cations (Mg^{2+} , K^+ , NH_4^+) and organic matter will be retained within a solid matrix, while other contaminants (such as nitrates) will remain in the water. There are numerous models for the remediation potential of contaminants and microorganisms, but predicting downstream or extracted water quality for a large suite of parameters is rarely feasible. Therefore, potable and non-potable water sources should be clearly identified, the most important parameters modelled and a risk assessment completed.

Operation & Maintenance Regular monitoring and sampling is important to ensure compliance with regulations and to ensure public health requirements. Depending on the recharge method, some mechanical maintenance may be required.

Pros & Cons

- + May provide a 'drought-proof' water supply (from groundwater)
- + May increase productivity of water bodies by maintaining constant levels
- Discharge of nutrients and micropollutants may affect natural water bodies and/or drinking water
- Introduction of pollutants may have long-term impacts
- May negatively affect soil and groundwater properties

References & Further Reading

- _ ARGOSS (2001). *Guidelines for Assessing the Risk to Groundwater from on-Site Sanitation*. British Geological Survey Commissioned Report, CR/01/142, Keyworth, UK. Available at: www.bgs.ac.uk
- _ Seiler, K. P. and Gat, J. R. (2007). *Groundwater Recharge from Run-off, Infiltration and Percolation*. Springer, Dordrecht, NL.
- _ Tchobanoglous, G., Burton, F. L. and Stensel, H. D. (2004). *Wastewater Engineering: Treatment and Reuse*, Metcalf & Eddy, 4th Ed. (Internat. Ed.). McGraw-Hill, New York, US.
- _ WHO (2006). *Guidelines for the Safe Use of Wastewater, Excreta and Greywater. Volume 3: Wastewater and Excreta Use in Aquaculture*. World Health Organization, Geneva, CH. Available at: www.who.int

Application Level:

- ★ Household
- ★ Neighbourhood
- ★★ City

Management Level:

- ★ Household
- ★★ Shared
- ★★ Public

Inputs:

- Sludge
- Pit Humus
- Compost
- Dried Faeces
- Dry Cleansing Materials
- Pre-Treatment Products

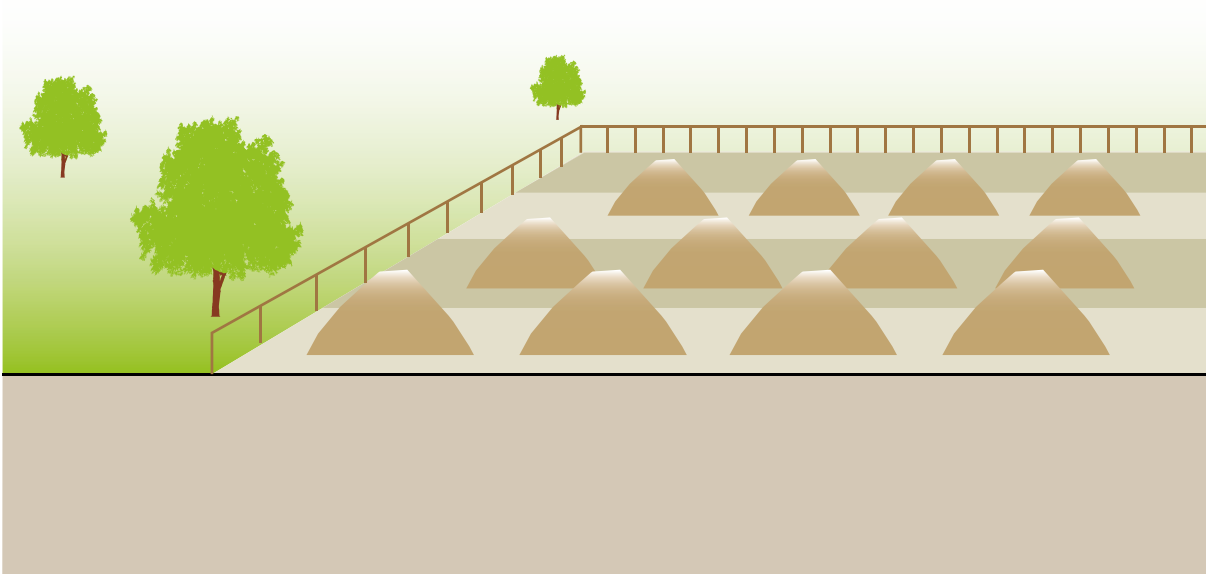

Surface disposal refers to the stockpiling of sludge, faeces or other materials that cannot be used elsewhere. Once the material has been taken to a surface disposal site, it is not used later. Storage refers to temporary stockpiling. It can be done when there is no immediate need for the material and a future use is anticipated, or when further pathogen reduction and drying is desired before application.

This technology is primarily used for sludge, although it is applicable for any type of dry, unusable material. One application of surface disposal is the disposal of dry cleansing materials, such as toilet paper, corn cobs, stones, newspaper and/or leaves. These materials cannot always be included along with other water-based products in some technologies and must be separated. A rubbish bin should be provided beside the User Interface to collect the cleansing materials and menstrual hygiene materials. Dry materials can be burned (e.g., corn cobs) or disposed of along with the household waste. For simplicity, the remainder of this technology information sheet will be dedicated to sludge since standard solid waste practices are beyond the scope of this Compendium.

When there is no demand for or acceptance of the beneficial use of sludge, it can be placed in monofills (sludge-only landfills) or heaped into permanent piles. Temporary storage contributes to further dehydration of the product and the die-off of pathogens before it is used.

Design Considerations Landfilling sludge along with municipal solid waste (MSW) is not advisable since it reduces the life of a landfill, which has been specifically designed for the containment of more noxious materials. As opposed to more centralized MSW landfills, surface disposal sites can be situated close to where the sludge is treated, limiting the need for long transport distances.

The main difference between surface disposal and land application is the application rate. There is no limit to the quantity of sludge that can be applied to the surface since nutrient loads or agronomic rates are not a concern. Attention must be paid, however, to groundwater contamination and leaching. More advanced surface disposal systems may incorporate a liner and leachate collection system in order to prevent nutrients and contaminants from infiltrating the groundwater.

Sites for the temporary storage of a product should be covered to avoid rewetting by rainwater and the generation of leachate.

Appropriateness Since there are no benefits gained from surface disposal, it should not be considered as a primary option. However, where sludge use is not easily accepted, the contained and controlled stockpiling of solids is far preferable to uncontrolled dumping.

Storage may, in some cases, be a good option to further dry and sanitize a material and to generate a safe, acceptable product. Storage may also be required to bridge the gap between supply and demand.

Surface disposal and storage can be practiced in almost every climate and environment, although they may not be feasible where there is frequent flooding or where the groundwater table is high.

Health Aspects/Acceptance If a surface disposal and storage site is protected (e.g., by a fence) and located far from the public, there should be no risk of contact or nuisance. The contamination of groundwater resources by leachate should be prevented by adequate siting and design. Care should be taken to protect the disposal or storage site from vermin and pooling water, both of which could exacerbate smell and vector problems.

Operation & Maintenance Staff should ensure that only appropriate materials are disposed of at the site and must maintain control over the traffic and hours of operation. Workers should wear appropriate protective clothing.

Pros & Cons

- + May prevent unmitigated disposal
- + Storage may render the product more hygienic
- + Can make use of vacant or abandoned land
- + Little operation skills or maintenance required
- + Low capital and operating costs
- Requires a large land area
- Potential leaching of nutrients and contaminants into groundwater
- Surface disposal hampers the beneficial use of a resource

- Odours may be noticeable, depending on prior treatment
- May require special spreading equipment

References & Further Reading

- Strande, L., Ronteltap, M. and Brdjanovic, D. (Eds.) (2014). *Faecal Sludge Management. Systems Approach for Implementation and Operation*. IWA Publishing, London, UK. Available at: www.sandec.ch (Detailed book compiling the current state of knowledge on all aspects related to FSM)
- U.S. EPA (1999). *Biosolids Generation, Use, and Disposal in the United States*. EPA-530/R-99-009. U.S. Environmental Protection Agency, Washington, D.C., US. Available at: www.epa.gov
- U.S. EPA (1994). *A Plain English Guide to the EPA Part 503 Biosolids Rule*. EPA832-R-93-003. U.S. Environmental Protection Agency, Washington, D.C., US. Available at: www.epa.gov

Application Level:	Management Level:	Inputs:  Biogas
<input checked="" type="checkbox"/> Household <input checked="" type="checkbox"/> Neighbourhood <input type="checkbox"/> City	<input checked="" type="checkbox"/> Household <input checked="" type="checkbox"/> Shared <input checked="" type="checkbox"/> Public	

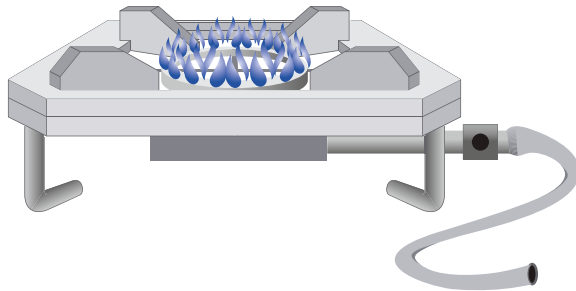

In principal, biogas can be used like other fuel gas. When produced in household-level biogas reactors, it is most suitable for cooking. Additionally, electricity generation is a valuable option when the biogas is produced in large anaerobic digesters.

Household energy demand varies greatly and is influenced by cooking and eating habits (i.e., hard grains and maize may require substantial cooking times, and, therefore, more energy compared to cooking fresh vegetables and meat). Biogas has an average methane content of 55–75%, which implies an energy content of 6–6.5 kWh/m³.

Design Considerations Gas demand can be defined on the basis of energy previously consumed. For example, 1 kg firewood roughly corresponds to 200 L biogas, 1 kg dried cow dung corresponds to 100 L biogas and 1 kg charcoal corresponds to 500 L biogas. Gas consumption for cooking per person and per meal is between 150 and 300 L biogas. Approximately 30–40 L biogas is required to cook one litre of water, 120–140 L for 0.5 kg rice and 160–190 L for 0.5 kg vegetables. Tests in Nepal and Tanzania have shown that the

consumption rate of a household biogas stove is about 300–400 L/h. However, this depends on the stove design and the methane content of the biogas. The following consumption rates in litres per hour (L/h) can be assumed for the use of biogas:

- household burners: 200–450 L/h
- industrial burners: 1,000–3,000 L/h
- refrigerator (100 L) depending on outside temperature: 30–75 L/h
- gas lamp, equivalent to a 60 W bulb: 120–150 L/h
- biogas/diesel engine per bhp: 420 L/h
- generation of 1 kWh of electricity with biogas/diesel mixture: 700 L/h
- plastics moulding press (15 g, 100 units) with biogas/diesel mixture: 140 L/h

Compared to other gases, biogas needs less air for combustion. Therefore, conventional gas appliances need to be modified when they are used for biogas combustion (e.g., larger gas jets and burner holes).

The distance through which the gas must travel should be minimized since losses and leakages may occur. Drip valves should be installed for the drainage of condensed water, which accumulates at the lowest points of the gas pipe.

Appropriateness The calorific efficiency of using biogas is 55% in stoves, 24% in engines, but only 3% in lamps. A biogas lamp is only half as efficient as a kerosene lamp. The most efficient way of using biogas is in a heat-power combination where 88% efficiency can be reached. But this is only valid for larger installations and under the condition that the exhaust heat is profitably used. For household application, the best way to use biogas is cooking.

Health Aspects/Acceptance In general, users enjoy cooking with biogas as it can immediately be switched on and off (as compared to wood and coal). Also, it burns without smoke, and, thus, does not lead to indoor air pollution. Biogas generated from faeces may not be appropriate in all cultural contexts. Assuming that the biogas plant is well-constructed, operated and maintained (e.g., water is drained), the risk of leaks, explosions or any other threats to human health is negligible.

Operation & Maintenance Biogas is usually fully saturated with water vapour, which leads to condensation. To prevent blocking and corrosion, the accumulated water has to be periodically emptied from the installed water traps. The gas pipelines, fittings and appliances must be regularly monitored by trained personnel. When using biogas for an engine, it is necessary to first reduce the hydrogen sulphide because it forms corrosive acids when combined with condensing water. The reduction of the carbon-dioxide content requires additional operational and financial efforts. As CO₂ “scrubbing” is not necessary when biogas is used for cooking, it is rarely advisable in developing countries.

Pros & Cons

- + Free source of energy
- + Reduction of indoor air pollution and deforestation (if firewood or coal was previously used)
- + Little operation skills or maintenance required
- May not fulfil total energy requirements
- Cannot replace all types of energy
- Cannot be easily stored (low energy density per volume) and, thus, needs to be continuously used

References & Further Reading

- Deublein, D. and Steinhauser, A. (2011). *Biogas from Waste and Renewable Resources*, 2nd Ed. Wiley-VCH, Weinheim, DE.
- Kossmann, W., Pönitz, U., Habermehl, S., Hoerz, T., Krämer, P., Klingler, B., Kellner, C., Wittur, T., von Klopotek, F., Krieg, A. and Euler H. (1999). *Biogas Digest Volume II – Application and Product Development*. GTZ, Eschborn, DE. Available at: www.susana.org/library
- Lohri, C. (2009a). *Research on Anaerobic Digestion of Organic Solid Waste at Household Level in Dar es Salaam, Tanzania*. Eawag (Department Sandec). Dübendorf, CH. Available at: www.sandec.ch
- Lohri, C. (2009b). *Evaluation of Biogas Sanitation Systems in Nepalese Prisons*. Eawag (Department Sandec), Dübendorf and ICRC, Geneva, CH.
- Mang, H.-P. and Li, Z. (2010). *Technology Review of Biogas Sanitation. Draft – Biogas Sanitation for Blackwater, Brown Water, or for Excreta Treatment and Reuse in Developing Countries*. Gesellschaft für Internationale Zusammenarbeit (GIZ) GmbH, Eschborn, DE. Available at: www.susana.org/library
- Vögeli, Y., Lohri, C. R., Gallardo, A., Diener, S. and Zurbrugg, C. (2014). *Anaerobic Digestion of Biowaste in Developing Countries. Practical Information and Case Studies*. Eawag (Department Sandec), Dübendorf, CH. Available at: www.sandec.ch

Emerging Sanitation Technologies

In addition to the established and proven technologies presented in Part 2 of the Compendium, numerous innovative sanitation technologies are being researched, developed and tested in the field. Emerging technologies are those that have moved beyond the laboratory and small-pilot phase, and are currently (as of June 2014) being implemented in relevant contexts (i.e., in a developing country) and at a scale that indicates that expansion is possible (i.e., not a single unit).

The International Year of Sanitation (IYS) 2008 galvanized the sanitation sector by increasing visibility, engaging new actors and opening new funding streams. The entry of new funding sources, such as the Bill & Melinda Gates Foundation (www.gatesfoundation.org) and the International Finance Corporation/Water and Sanitation Program (www.ifc.org/sellingsanitation), and increased visibility and political will, have enabled substantial sector funding and innovation in the past few years.

There are many innovative, exciting technologies under research and development; they are too numerous to include in this section. Most of these innovations, however, are currently still too costly, too technically complex and/or resource intensive for widespread application, or have not yet been proven at a significant scale in developing countries. Yet, several recently developed technologies have moved beyond the laboratory phase, are being applied in a developing country context, and at a scale indicating that sustainable dissemination is feasible. Some of the most promising emerging technologies that have already been proven in the field under variable operational and waste composition conditions are listed below.

Many of the innovations in the sanitation field relate to business models and logistics. A variety of social enterprises are seeking to develop sustainable business models that provide technology and/or collection and/or treatment services at a low cost to unserved communities, which were previously considered too poor to pay for sanitation. Indeed, “Base of the Pyramid” customers are gaining increased atten-

tion because of their collective demand and purchasing power.

We are looking forward to updating the Compendium with additional technologies and business models in the future when more have proven to be financially and technically sustainable. Here, we briefly summarize some of the most promising, widespread innovations which we expect to become commonplace in the years to come.

Peepoo The Peepoo bag is a biodegradable bag designed for excreta collection when a permanent User Interface technology is not available. It is a single-use bag that is meant to be held in one hand or put over a small holder (e.g., a small bucket or a cut PET bottle) and has 2 layers. The inner layer is folded over the hand to protect it or over a small container. After defecating or urinating into the inner layer, the outer bag is tied shut. The difference between the Peepoo bag and a regular plastic bag is the fact that (a) the inside bag is coated with urea which disinfects the faeces, and (b) the bag is biodegradable. Full bags should be transported to a composting facility before they start to break down (about 4 weeks). They are made of a bio-plastic that breaks down into water, carbon dioxide and biomass. Therefore, they do not need to be removed from, and actually contribute to, the composting process. The bags are safe to handle and remain odour free for at least 24 h, giving the user time to safely transport them to an appropriate collection point. The bags are light (about 12 grams) and can hold up to 800 mL of excreta. They are not meant to replace a permanent technology (e.g., VIP, S.3), but are recommended for use as a sanitation solution for people who do not have access to any (e.g., internally displaced persons, emergency situations, etc.). They can also be used by people who, for safety reasons, cannot access their closest sanitation facility (e.g., if shared toilets are too far or closed at night). The challenge, as with other mobile/container based sanitation technologies, is the effective management of collecting and composting the bags. The Peepoo bag has been extensively used in Kenya, the Philippines, South Africa, and Bangladesh, among other places.

Compost Filter Several variations of the compost filter exist. Its concept is based on combined filtration and aerobic digestion of solids. Unlike a Septic Tank (S.9), where solids settle to the bottom and degrade under anaerobic conditions, the solids are separated from liquids by a porous medium (filter bed or bag) in a compost filter. They remain on/in the filter and are then broken down by the aerobic organisms that survive in the organic matrix. Maintaining a low volume of water in the collected solids is essential to the success of the compost filter. Thereby, the filter is able to maintain aerobic conditions without being saturated. This can be ensured by regularly adding layers of straw or wood chips to it. Different design variations exist. There are permanent filters made, for example, from concrete, or removable filter bags that can be used to support the organic filter material. In addition, the design determines how frequently the accumulating solids need to be removed and further treated, as well as how long the process can continue without replacing the filter. A double-chamber design works on the principle of alternation (as with Dehydration Vaults for faeces, S.7, or Twin Pits for Pour Flush, S.6); each side can be used

for a year, and the content is then allowed to rest and decompose while the other side is in use. There are also designs that work continuously with a single chamber (e.g., the Biofil Digester, see references). Essential to the compost filter design is secondary treatment of the effluent, e.g., in a Constructed Wetland (T.7-T.9) and/or Waste Stabilization Ponds (T.5). Depending on the intended end-use, the composted solids may also require further treatment.

LaDePa Sludge Pelletizer The Latrine Dehydration and Pasteurisation (LaDePa) pelletizer is a sludge drying and pasteurization technology capable of producing a dry, pelletized soil amender from pit latrine sludge. It can be fed at a rate of about 1,000 kg/h sludge (30-35% solids content) and the output rate is about 300 kg/h dried pellets (60-65 % solids content). Garbage that ends up in pits (plastic bags, shoes, etc.) is separated from the sludge by a screw compactor: the screw pushes the sludge through 6 mm holes onto a porous, continuous steel belt, while the waste material is ejected through a separate outlet so that it can be collected and disposed of.

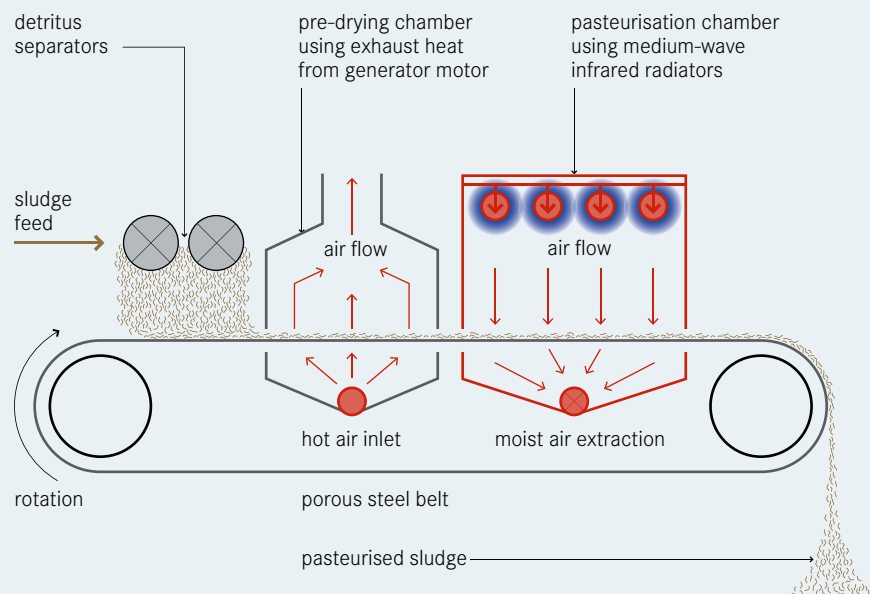

Figure 6: Schematic of the LaDePa sludge pelletizer

The extruded sludge falls in an open matrix of spaghetti-like strands, in a layer varying in thickness from 25–40 mm, onto the porous belt and passes first through a pre-drying section that utilizes the waste heat from the internal combustion engine of the power plant. The partially dried sludge pellets then travel through a patented “Parseps Dryer” that makes use of medium-wave infrared radiation. The pellets are, thereby, pasteurized and dried by using an extractor fan that draws the hot air through the porous belt and the open matrix of sludge. This increases the drying capability without increasing the energy output. The pellets that emerge are free of pathogens and suitable for all edible crops. The whole process takes 16 minutes. An important disadvantage of the LaDePa process is that it is relatively energy intensive and relies on a constant source of energy (electricity/diesel).

The eThekweni Municipality in Durban, South Africa, has been running LaDePa trials for about 2 years. Evidence from the trials, in conjunction with their VIP pit emptying program, indicates that they should be able to treat approximately 2,000 t of VIP sludge a year with one plant. The product has a registered trademark (GrowEtheK) and, once the product has been licensed as a low nutrient fertilizer, it will be bagged and sold. Based on the sale price of GrowEtheK, the LaDePa generates about \$27/h, which can offset the operating costs. The LaDePa was designed by Particle Separation Systems (PSS), which offers the equipment on a rental basis or for sale. If the rental option is preferred, there is an establishment fee and a maintenance contract. If the equipment is purchased outright, there would still be a maintenance contract, but no establishment fee.

Struvite Production from Urine Urine contains most of the excess nutrients excreted from the body. Nitrogen and phosphorus are two elements essential for plant growth and are present in urine in significant amounts (concentrations vary dramatically, but values around 250 mg/L $\text{PO}_4\text{-P}$ and 2,500 mg/L $\text{NH}_4\text{-N}$ are not atypical). In order to take advantage of the nutrients, including potassium, sulphur, etc.,

stored urine can be directly applied to crops and fields (see D.2), or processed into a solid fertilizer called struvite ($\text{NH}_4\text{MgPO}_4\cdot 6\text{H}_2\text{O}$). Struvite is produced by adding some kind of soluble magnesium source (magnesium chloride, bittern or wood ash) to the urine. Magnesium binds with the phosphorus and nitrogen, and precipitates out into a white, crystalline form. Struvite crystals must be filtered out of the solution, dried and then processed into a useable form. It is currently produced in Durban, South Africa, from 1,000 litres of urine per day that is collected from household urine-diverting dry toilets. When there is no use or desire for urine-derived nutrients (e.g., in dense urban areas), struvite is a convenient way of producing a compact nutrient product that can be easily stored, transported and used when and where it is needed. A disadvantage, however, is that struvite production produces an equivalent volume of effluent with a high pH and ammonium concentration that requires further treatment. Other important elements, such as potassium, also remain in the solution. Yet, struvite production is simple, requiring little more than a mixing chamber and filter, and has been proven to work in many countries and contexts. As a first step in a nutrient recovery strategy, it is effective, but should not be implemented without a subsequent effluent treatment strategy. Examples of effective effluent management are drip irrigation systems that distribute the liquid directly onto crop roots, although the distribution is limited by head and available area, or nitrification of the urine (which is still in the development phase).

Struvite can also be recovered from wastewater streams, specifically from digester supernatant, which has higher concentrations of phosphorus than blackwater, though the mixing and dosing technology are more complicated. Ostara (see references) is one of several companies that has installed their proprietary technologies at large wastewater treatment plants.

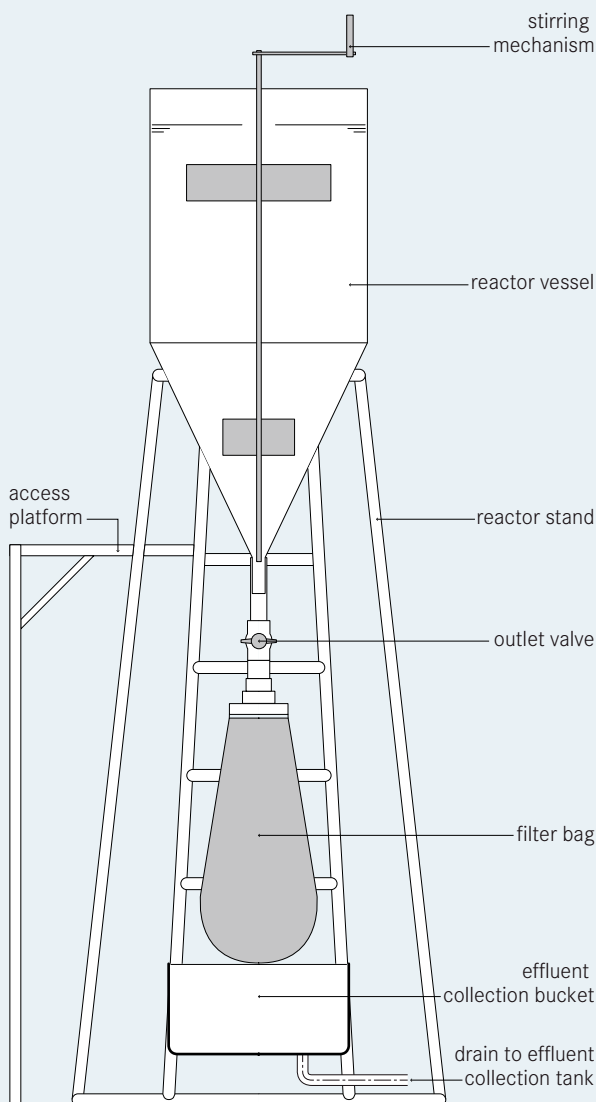

Figure 7: Schematic of a struvite reactor with stirring mechanism and filter bag

References & Further Reading

Peepoo:

- Peepoople. www.peepoople.com (last accessed April 2014)
- Vinnerås, B., Hedenkvist, M., Nordin, A. and Wilhelmson, A. (2009). *Peepoo Bag: Self-Sanitising Single Use Biodegradable Toilet*. *Water Science & Technology* 59 (9): 1743-1749.

Compost Filter:

- Biofil (n.d.). *The Biofil Toilet System. The Toilet Facility that Makes Good Sanitation Sense*.
- Biofilcom. www.biofilcom.org (last accessed April 2014)
- Gajurel, D. R., Li, Z. and Otterpohl, R. (2003). *Investigation of the Effectiveness of Source Control Sanitation Concepts Including Pre-Treatment with Rottebehaelter*. *Water Science & Technology* 48 (1): 111-118.

- Hoffmann, H., Rüd, S. and Schöpe, A. (2009). *Blackwater and Greywater Reuse System Chorrillos, Lima, Peru – Case Study of Sustainable Sanitation Projects*. Sustainable Sanitation Alliance (SuSanA), Eschborn, DE. Available at: www.susana.org/library

LaDePa Sludge Pelletizer:

- Harrison, J. and Wilson, D. (2012). *Towards Sustainable Pit Latrine Management through LaDePa*. *Sustainable Sanitation Practice* 13: 25-32. Available at: www.ecosan.at/ssp

- Particle Separation Systems. www.parsep.co.za (last accessed April 2014)

- Wilson, D. and Harrison, J. Personal communication (February 2014)

Struvite Production from Urine:

- Etter, B., Tilley, E., Khadka, R. and Udert, K. M. (2011). *Low-Cost Struvite Production Using Source-Separated Urine in Nepal*. *Water Research* 45 (2): 852-862.
- Grau, M. G. P., Rhoton, S. L., Brouckaert, C. J. and Buckley, C. A. (2013). *Development of a Fully Automated Struvite Reactor to Recover Phosphorus from Source Separated Urine Collected at Urine Diversion Toilets in eThekweni*. WEF/IWA International Conference on Nutrient Removal and Recovery 2013, 28-31 July, Vancouver, CA. Available at: www.eawag.ch/vuna
- Nutrient Valorization from Urine in Nepal (STUN). www.eawag.ch/stun (last accessed April 2014)
- Ostara Nutrient Recovery Technologies Inc. www.ostara.com (last accessed April 2014)

Glossary

Activated Sludge: See T.12

Aerated Pond: See T.6

Aerobic: Describes biological processes that occur in the presence of oxygen.

Aerobic Pond: A lagoon that forms the third treatment stage in Waste Stabilization Ponds. See T.5 (Syn.: Maturation Pond, Polishing Pond)

Anaerobic: Describes biological processes that occur in the absence of oxygen.

Anaerobic Baffled Reactor (ABR): See S.10 and T.3

Anaerobic Digester: See S.12 and T.17 (Syn.: Biogas Reactor)

Anaerobic Digestion: The degradation and stabilization of organic compounds by microorganisms in the absence of oxygen, leading to production of biogas.

Anaerobic Filter: See S.11 and T.4

Anaerobic Pond: A lagoon that forms the first treatment stage in Waste Stabilization Ponds. See T.5

Anal Cleansing Water: See Products, p. 10

Anoxic: Describes the process by which nitrate is biologically converted to nitrogen gas in the absence of oxygen. This process is also known as denitrification.

Application of Dehydrated Faeces: See D.3

Application of Pit Humus and Compost: See D.4

Application of Sludge: See D.5

Application of Stored Urine: See D.2

Aquaculture: The controlled cultivation of aquatic plants and animals. See Fish Pond (D.9) and Floating Plant Pond (D.10)

Aquifer: An underground layer of permeable rock or sediment (usually gravel or sand) that holds or transmits groundwater.

Arborloo: See D.1

Bacteria: Simple, single cell organisms that are found everywhere on earth. They are essential for maintaining life and per-

forming essential “services”, such as composting, aerobic degradation of waste, and digesting food in our intestines. Some types, however, can be pathogenic and cause mild to severe illnesses. Bacteria obtain nutrients from their environment by excreting enzymes that dissolve complex molecules into more simple ones which can then pass through the cell membrane.

Bar Rack: See PRE, p. 100 (Syn.: Screen, Trash Trap)

Biochemical Oxygen Demand (BOD): A measure of the amount of oxygen used by microorganisms to degrade organic matter in water over time (expressed in mg/L and normally measured over five days as BOD₅). It is an indirect measure of the amount of biodegradable organic material present in water or wastewater: the more the organic content, the more oxygen is required to degrade it (high BOD).

Biodegradation: Biological transformation of organic material into more basic compounds and elements (e.g., carbon dioxide, water) by bacteria, fungi, and other microorganisms.

Biogas: See Products, p. 10

Biogas Combustion: See D.13

Biogas Reactor: See S.12 and T.17 (Syn.: Anaerobic Digester)

Biomass: See Products, p. 10

Blackwater: See Products, p. 10

Brownwater: See Products, p. 10

Capital Cost: Funds spent for the acquisition of a fixed asset, such as sanitation infrastructure.

Centralized Treatment: See Functional Group T, p. 98

Cesspit: An ambiguous term either used to describe a Soak Pit (Leach Pit), or a Holding Tank. (Syn.: Cesspool)

Cesspool: See Cesspit (Syn.)

Chemical Oxygen Demand (COD): A measure of the amount of oxygen required for chemical oxidation of organic material in water by a strong chemical oxidant (expressed in mg/L). COD is always equal to or higher than BOD since it is the total oxygen required for complete oxidation. It is an indirect measure of the amount of organic material present in water or wastewater: the more the organic content, the more oxygen is required to chemically oxidize it (high COD).

Cistern Flush Toilet: See U.5

Clarifier: See T.1 (Syn.: Settler, Sedimentation/Settling Tank/Basin)

C:N Ratio: The ratio of the mass of carbon to the mass of nitrogen in a substrate.

Coagulation: The destabilization of particles in water by adding chemicals (e.g., aluminium sulphate or ferric chloride) so that they can aggregate and form larger flocs.

Co-Composting: See T.16

Collection and Storage/Treatment: See Functional Group S, p. 56

Compost: See Products, p. 10

Composting: The process by which biodegradable components are biologically decomposed by microorganisms (mainly bacteria and fungi) under controlled aerobic conditions.

Composting Chamber: See S.8

Condominial Sewer: See C.4 (Syn.: Simplified Sewer)

Constructed Wetland: A treatment technology for wastewater that aims to replicate the naturally occurring processes in wetlands. See T.7-T.9

Conventional Gravity Sewer: See C.6

Conveyance: See Functional Group C, p. 82

Cyst: An environmentally resistant stage of a microorganism that helps it to survive periods of environmentally harsh conditions. Some protozoan parasites form infective, highly resistant cysts (e.g., *Giardia*) and oocysts (thick-walled spores, e.g., *Cryptosporidium*) during their life cycle.

Decentralized Wastewater Treatment System (DEWATS): A small-scale system used to collect, treat, discharge, and/or reclaim wastewater from a small community or service area.

Dehydrated Faeces: See Products, p. 11 (Syn.: Dried Faeces)

Dehydration Vaults: See S.7

Desludging: The process of removing the accumulated sludge from a storage or treatment facility.

Detention Time: See Hydraulic Retention Time (Syn.)

Dewatering: The process of reducing the water content of a sludge or slurry. Dewatered sludge may still have a significant moisture content, but it typically is dry enough to be conveyed as a solid (e.g., shovelled).

Digestate: The solid and/or liquid material remaining after undergoing anaerobic digestion.

Disinfection: The elimination of (pathogenic) microorganisms by inactivation (using chemical agents, radiation or heat) or by physical separation processes (e.g., membranes). See POST, p. 136

Disposal: See Functional Group D, p. 138

Double Ventilated Improved Pit (VIP): See S.4

Dried Faeces: See Products, p. 11 (Syn.: Dehydrated Faeces)

Dry Cleansing Materials: See Products, p. 11

Dry Toilet: See U.1

EcoHumus: See Pit Humus (Syn.)

E. coli: *Escherichia coli*, a bacterium inhabiting the intestines of humans and warm-blooded animals. It is used as an indicator of faecal contamination of water.

Ecological Sanitation (EcoSan): An approach that aims to safely recycle nutrients, water and/or energy contained in excreta and wastewater in such a way that the use of non-renewable resources is minimized. (Syn.: Resources-Oriented Sanitation)

Effluent: See Products, p. 11

Emerging Technology: A technology that has moved beyond the laboratory and small-pilot phase and is being implemented at a scale that indicates that expansion is possible. See p. 166

End-Use: The utilisation of products derived from a sanitation system. (Syn.: Use)

Environmental Sanitation: Interventions that reduce people exposure to disease by providing a clean environment in which to live, with measures to break the cycle of disease. This usually includes hygienic management of human and animal excreta, solid waste, wastewater, and stormwater; the con-

trol of disease vectors; and the provision of washing facilities for personal and domestic hygiene. Environmental Sanitation involves both behaviours and facilities that work together to form a hygienic environment.

Eutrophication: The enrichment of water, both fresh and saline, by nutrients (especially the compounds of nitrogen and phosphorus) that accelerate the growth of algae and higher forms of plant life and lead to the depletion of oxygen.

Evaporation: The phase change from liquid to gas that takes place below the boiling temperature and normally occurs on the surface of a liquid.

Evapotranspiration: The combined loss of water from a surface by evaporation and plant transpiration.

Excreta: See Products, p. 11

Facultative Pond: A lagoon that forms the second treatment stage in Waste Stabilization Ponds. See T.5

Faecal Sludge: See Product Sludge, p. 12

Faeces: See Products, p. 11

Fill and Cover: See D.1

Filtrate: The liquid that has passed through a filter.

Filtration: A mechanical separation process using a porous medium (e.g., cloth, paper, sand bed, or mixed media bed) that captures particulate material and permits the liquid or gaseous fraction to pass through. The size of the pores of the medium determines what is captured and what passes through.

Fish Pond: See D.9

Flotation: The process whereby lighter fractions of a wastewater, including oil, grease, soaps, etc., rise to the surface, and thereby can be separated.

Floating Plant Pond: See D.10 (Syn.: Macrophyte Pond)

Flocculation: The process by which the size of particles increases as a result of particle collision. Particles form aggregates or flocs from finely divided particles and from chemically destabilized particles and can then be removed by settling or filtration.

Flushwater: See Products, p. 11

Fossa Alterna: See S.5

Free-Water Surface Constructed Wetland: See T.7

Functional Group: See Compendium Terminology, p. 12

Grease Trap: See PRE, p. 100

Greywater: See Products, p. 11

Grit Chamber: See PRE, p. 100 (Syn.: Sand Trap)

Groundwater: Water that is located beneath the earth's surface.

Groundwater Recharge: See D.11

Groundwater Table: The level below the earth's surface which is saturated with water. It corresponds to the level where water is found when a hole is dug or drilled. A groundwater table is not static and can vary by season, year or usage (Syn.: Water Table).

Helminth: A parasitic worm, i.e. one that lives in or on its host, causing damage. Some examples that infect humans are roundworms (e.g., *Ascaris* and hookworm) and tapeworms. The infective eggs of helminths can be found in excreta, wastewater and sludge. They are very resistant to inactivation and may remain viable in faeces and sludge for several years.

Horizontal Subsurface Flow Constructed Wetland: See T.8

Human-Powered Emptying and Transport: See C.2

Humus: The stable remnant of decomposed organic material. It improves soil structure and increases water retention, but has no nutritive value.

Hydraulic Retention Time (HRT): The average amount of time that liquid and soluble compounds stay in a reactor or tank. (Syn.: Detention Time)

Imhoff Tank: See T.2

Improved Sanitation: Facilities that ensure hygienic separation of human excreta from human contact.

Influent: The general name for the liquid that enters into a system or process (e.g., wastewater).

Irrigation: See D.6

Jerrycan: See C.1

Leachate: The liquid fraction that is separated from the solid component by gravity filtration through media (e.g., liquid that drains from drying beds).

Leach Field: See D.8

Leach Pit: See Soak Pit (Syn.)

Lime: The common name for calcium oxide (quicklime, CaO) or calcium hydroxide (slaked or hydrated lime, Ca(OH)₂). It is a white, caustic and alkaline powder produced by heating limestone. Slaked lime is less caustic than quicklime and is widely used in water/wastewater treatment and construction (for mortars and plasters).

Log Reduction: Organism removal efficiencies. 1 log unit = 90%, 2 log units = 99%, 3 log units = 99.9%, and so on.

Macrophyte Pond: See D.10 (Syn.: Floating Plant Pond)

Macrophyte: An aquatic plant large enough to be readily visible to the naked eye. Its roots and differentiated tissues may be emergent (reeds, cattails, bulrushes, wild rice), submergent (water milfoil, bladderwort) or floating (duckweed, lily pads).

Maturation Pond: See Aerobic Pond (Syn.)

Methane: A colourless, odourless, flammable, gaseous hydrocarbon with the chemical formula CH₄. Methane is present in natural gas and is the main component (50-75%) of biogas that is formed by the anaerobic decomposition of organic matter.

Microorganism: Any cellular or non-cellular microbiological entity capable of replication or of transferring genetic material (e.g., bacteria, viruses, protozoa, algae or fungi).

Micropollutant: Pollutant that is present in extremely low concentrations (e.g., trace organic compounds).

Motorized Emptying and Transport: See C.3

Night Soil: A historical term for faecal sludge.

Nutrient: Any substance that is used for growth. Nitrogen (N), phosphorus (P) and potassium (K) are the main nutrients contained in agricultural fertilizers. N and P are also primarily responsible for the eutrophication of water bodies.

Offsite Sanitation: A sanitation system in which excreta and wastewater are collected and conveyed away from the plot where they are generated. An offsite sanitation system relies on a sewer technology (see C.4-C.6) for conveyance.

Onsite Sanitation: A sanitation system in which excreta and wastewater are collected and stored or treated on the plot where they are generated.

Oocyst: See Cyst

Operation and Maintenance (O&M): Routine or periodic tasks required to keep a process or system functioning according to performance requirements and to prevent delays, repairs or downtime.

Organics: See Products, p. 11

Parasite: An organism that lives on or in another organism and damages its host.

Pathogen: An organism or other agent that causes disease.

Percolation: The movement of liquid through a filtering medium with the force of gravity.

pH: The measure of acidity or alkalinity of a substance. A pH value below 7 indicates that it is acidic, a pH value above 7 indicates that it is basic (alkaline).

Pit Humus: See Products, p. 11 (Syn.: EcoHumus)

Planted Drying Beds: See T.15

Polishing Pond: See Aerobic Pond (Syn.)

Post-Treatment: See POST, p. 136 (Syn.: Tertiary Treatment)

Pour Flush Toilet: See U.4

Pre-Treatment: See PRE, p. 100

Pre-Treatment Products: See Products, p. 12

Primary Treatment: The first major stage in wastewater treatment that removes solids and organic matter mostly by the process of sedimentation or flotation.

Product: See Compendium Terminology, p. 10

Protozoa: A diverse group of unicellular eukaryotic organisms,

including amoeba, ciliates, and flagellates. Some can be pathogenic and cause mild to severe illnesses.

Resources-Oriented Sanitation: See Ecological Sanitation (Syn.)

Reuse: Use of recycled water.

Runoff: see Surface Runoff

Sand Trap: See PRE, p. 100 (Syn.: Grit Chamber)

Sanitation: The means of safely collecting and hygienically disposing of excreta and liquid wastes for the protection of public health and the preservation of the quality of public water bodies and, more generally, of the environment.

Sanitation System: See Compendium Terminology, p. 10

Sanitation Technology: see Compendium Terminology, p. 13

Screen: See PRE, p. 100 (Syn.: Bar Rack, Trash Trap)

Scum: The layer of solids formed by wastewater constituents that float to the surface of a tank or reactor (e.g., oil and grease).

Secondary Treatment: Follows primary treatment to achieve the removal of biodegradable organic matter and suspended solids from effluent. Nutrient removal (e.g., phosphorus) and disinfection can be included in the definition of secondary treatment or tertiary treatment, depending on the configuration.

Sedimentation: Gravity settling of particles in a liquid such that they accumulate. (Syn.: Settling)

Sedimentation Tank/Basin: See T.1 (Syn.: Settler, Clarifier, Settling Tank/Basin)

Sedimentation/Thickening Ponds: See T.13

(Semi-) Centralized Treatment: See Functional Group T, p. 98

Septage: A historical term to define sludge removed from septic tanks.

Septic: Describes the conditions under which putrefaction and anaerobic digestion take place.

Septic Tank: See S.9

Settled Sewer: See C.5 (Syn.: Solids-Free Sewer, Small-Bore Sewer)

Settler: See T.1 (Syn.: Clarifier, Sedimentation/Settling Tank/Basin)

Settling: See Sedimentation (Syn.)

Settling Tank/Basin: See T.1 (Syn.: Settler, Clarifier, Sedimentation Tank/Basin)

Sewage: Waste matter that is transported through the sewer.

Sewer: An open channel or closed pipe used to convey sewage. See C.4-C.6

Sewerage: The physical sewer infrastructure (sometimes used interchangeably with sewage).

Sewer Discharge Station: See C.7

Simplified Sewer: See C.4 (Syn.: Condominial Sewer)

Single Pit: See S.2

Single Ventilated Improved Pit (VIP): See S.3

Sitter: Someone who prefers to sit on the toilet, rather than squat over it.

Sludge: See Products, p. 12.

Small-Bore Sewer: See C.5 (Syn.: Solids-Free Sewer, Settled Sewer)

Soak Pit: See D.7 (Syn.: Leach Pit)

Soil Conditioner: A product that enhances the water and nutrient retaining properties of soil.

Solids-Free Sewer: See C.5 (Syn.: Small-Bore Sewer, Settled Sewer)

Specific Surface Area: The ratio of the surface area to the volume of a solid material (e.g., filter media).

Squatter: Someone who prefers to squat over the toilet, rather than sit directly on it.

Stabilization: The degradation of organic matter with the goal of reducing readily biodegradable compounds to lessen environmental impacts (e.g., oxygen depletion, nutrient leaching).

Stored Urine: See Products, p. 12

Stormwater: See Products, p. 12

Sullage: A historical term for greywater.

Superstructure: The walls and roof built around a toilet or bathing facility to provide privacy and protection to the user.

Surface Disposal and Storage: See D.12

Surface Runoff: The portion of precipitation that does not infiltrate the ground and runs overland.

Surface Water: A natural or man-made water body that appears on the surface, such as a stream, river, lake, pond, or reservoir.

System Template: See p. 15

Tertiary Filtration: Application of filtration processes for tertiary treatment of effluent. See POST, p. 136

Tertiary Treatment: Follows secondary treatment to achieve enhanced removal of pollutants from effluent. Nutrient removal (e.g., phosphorus) and disinfection can be included in the definition of secondary treatment or tertiary treatment, depending on the configuration. See POST, p. 136 (Syn.: Post-Treatment)

Thickening Ponds: See T.13

Toilet: User interface for urination and defecation.

Total Solids (TS): The residue that remains after filtering a water or sludge sample and drying it at 105 °C (expressed in mg/L). It is the sum of Total Dissolved Solids (TDS) and Total Suspended Solids (TSS).

Transfer Station: See C.7 (Syn.: Underground Holding Tank)

Trash Trap: See PRE, p. 100 (Syn.: Screen, Bar Rack)

Trickling Filter: See T.10

Twin Pits for Pour Flush: See S.6

Underground Holding Tank: See C.7 (Syn.: Transfer Station)

Unplanted Drying Beds: See T.14

Upflow Anaerobic Sludge Blanket Reactor (UASB): See T.11

Urea: The organic molecule $(\text{NH}_2)_2\text{CO}$ that is excreted in urine and that contains the nutrient nitrogen. Over time, urea breaks down into carbon dioxide and ammonium, which is readily used by organisms in soil.

Urinal: See U.3

Urine: See Products, p. 12

Urine-Diverting Dry Toilet (UDDT): See U.2

Urine-Diverting Flush Toilet (UDFT): See U.6

Urine Storage Tank: See S.1

Use and/or Disposal: See Functional Group D, p. 138

User Interface: See Functional Group U, p. 42

Vector: An organism (most commonly an insect) that transmits a disease to a host. For example, flies are vectors as they can carry and transmit pathogens from faeces to humans.

Vertical Flow Constructed Wetland: See T.9

Virus: An infectious agent consisting of a nucleic acid (DNA or RNA) and a protein coat. Viruses can only replicate in the cells of a living host. Some pathogenic viruses are known to be water-borne (e.g., the rotavirus that can cause diarrheal disease).

Washer: Someone who prefers to use water to cleanse after defecating, rather than wipe with dry material.

Waste Stabilization Ponds (WSP): See T.5

Wastewater: Used water from any combination of domestic, industrial, commercial or agricultural activities, surface runoff/stormwater, and any sewer inflow/infiltration.

Water Disposal: See D.11

Water Table: See Groundwater Table (Syn.)

Wiper: Someone who prefers to use dry material (e.g., toilet paper or newspapers) to cleanse after defecating, rather than wash with water.

Bibliographic Reference:

Tilley, E., Ulrich, L., Lüthi, C., Reymond, Ph., Schertenleib, R. and Zurbrügg, C., 2014.
Compendium of Sanitation Systems and Technologies. 2nd Revised Edition.
Swiss Federal Institute of Aquatic Science and Technology (Eawag).
Dübendorf, Switzerland.

ISBN: 978-3-906484-57-0

© Eawag: Swiss Federal Institute of Aquatic Science and Technology,
Department Water and Sanitation in Developing Countries (Sandec)
Dübendorf, Switzerland, www.sandec.ch

This document is published by Eawag, which is a WHO Collaborating Centre; it is not a publication of the World Health Organization. Eawag is responsible for the views expressed in this document and the views do not necessarily represent the decisions or policies of the World Health Organization.

Permission is granted for reproduction of this material, in whole or part, for education, scientific or development related purposes except those involving commercial sale, provided that full citation of the source is given.

A free PDF copy of this publication can be downloaded from www.sandec.ch/compendium.

Graphic Design & Technical Drawings:

Pia Thür, Zürich & Paolo Monaco | Designport GmbH, Zürich

Text Editing: Paul Donahue

Photos: Eawag (Sandec)

Second Edition: 2500 Copies

Printed by: Imprimerie Nouvelle Gonnet, Belley, France



Eawag
Department Sandec
Überlandstrasse 133
P.O. Box 611
8600 Dübendorf
Switzerland
Phone +41 (0)44 823 52 86
info@sandec.ch
www.eawag.ch
www.sandec.ch

Water Supply & Sanitation
Collaborative Council
15 Chemin Louis-Dunant
1202 Geneva
Switzerland
www.wsscc.org

International Water Association (IWA)
Alliance House
12 Caxton Street
London SW 1H 0QS
United Kingdom
www.iwahq.org

This second, revised edition of the Compendium pulls together a huge range of information on sanitation systems and technologies in one volume. By ordering and structuring tried and tested technologies into one concise document, the reader is provided with a useful planning tool for making more informed decisions.

Part 1 describes different system configurations for a variety of contexts.

Part 2 consists of 57 different technology information sheets, which describe the main advantages, disadvantages, applications and the appropriateness of the technologies required to build a comprehensive sanitation system. Each technology information sheet is complemented by a descriptive illustration.