

Department of Geosciences, University of Basel  
Institute of Geography

# **Ecological Sanitation in the Khuvsgul Area, Northern Mongolia: Socio-Cultural Parameters and Acceptance**

An Evaluation of the Current Sanitation Situation in the Khuvsgul Area  
and a Study about the Acceptance and Suitability  
of the Ecosan Approach in Mongolia

Master's Thesis in the College of Social Sciences

**Katharina Conradin**

November 2007

Supervisor: Prof. (em.) Dr. rer. nat. Dr. h.c. Hartmut Leser  
Co-Supervisor: Dr. rer. nat. Johannes Heeb

© 2007:

Katharina Conradin  
Winkelriedplatz 2  
CH-4053 Basel  
Switzerland  
+41 (0)79 660 38 66  
k.conradin@gmail.com

## ***Preface and Acknowledgements***

This thesis would not have been written had there not been a series of coincidences. Had I and my partner not chosen to go mountaineering in Mongolia, I would never have gotten to know this beautiful country. And had we not been so exhausted after six weeks of hard mountain climbing, we may not have gone to Lake Khuvsgul at all. Once there, I had recognized the need for sanitary improvements at once, but thought a project impossible just on my own. Had not a series of mishaps lead to the fact that we were among the last people to check in at the small airport in Muren, the capital town of the Khuvsgul aimag, I would never have stood behind Kent Madin, a lodge operator in Khatgal, who – also coincidentally – happened to walk around with a urine-separating toilet under his arms... It was this coincidental meeting which started this thesis.

I owe Kent and his Mongolian partner Chinbat my deepest gratitude. They must obviously have been so impressed by my persistence and enthusiasm I displayed at the airport in Muren that they almost unrestrictedly supported me and my partners Jacqueline von Arx and Oyunmunkh Byambaa in realising this research project, at first in planning and organisation, and during our stay in Khatgal with accommodation and lodging. Without their help, we all could not have completed our Masters in such a great way. Similarly, I would also like to thank the staff at Khuvsgul Inn, above all Uka, for all their help during our fieldwork.

Secondly, I must thank Jacqueline von Arx. She has embarked on this adventure in an unbelievably passionate and straightforward way, has been a great research partner and has become an even better friend during our shared time in the middle of nowhere.

Deep thanks to Prof. Dr. Hartmut Leser, who taught me a passion for geography – I am grateful that I was able to be his student. He backed this slightly unusual project from the first moment. Likewise, I am very much indebted to Dr. Johannes Heeb, who introduced me to ecosan in the first place. He let me conduct this study independently and still gave valuable advice from wherever in the world he was. As well, I am obliged to Prof. Dr. Michael Walther, who supported this project without knowing me at first, and helped us in establishing a small research partnership between the National University of Mongolia and the University of Basel.

Furthermore, I must thank Oyunmunkh Byambaa, our partner student from the National University of Mongolia, who has been an immense help during our fieldwork. She has made me understand Mongolia better in both a literal and a figurative sense.

In Mongolia, I am very indebted to Tuvshin from the Gandan Guesthouse in Ulaanbaatar. He is much more than just a guesthouse owner, but a guide, organiser, taxi driver and friend all in one. I would also like to express my thanks to Buya, who had to run around in Ulaanbaatar for days to organise our visa. Similarly, I would like to thank the staff of Boojum expeditions, who have frequently lent me a helping hand. In Khatgal, Gerelee and his family have always welcomed me like a daughter, and their hospitality has been extraordinary. Special thanks to Erdenetsooj for his immense help with the reforestation project. I would also like to thank to the following persons who have in one or the other way contributed to my thesis or have made my stay in Mongolia more special: Ganbaatar, Ganbaa, Jimmy, Byambaa, Odnoo, Togii, Enkhee, Bayanjargal, Enkhtuvshin, Mr. Baatarbileg, and Ariunbold.

In Switzerland, thanks Martin Wafler for his technical advice, and Sascha Amhof for his introduction to GIS. And of course, I am very grateful that the KFPE granted the necessary financial support, without which this project would not have been realisable.

A number of people have contributed to improve the quality of this thesis by investing time in proofreading and commenting. I deeply thank Michael Kropac, Chauntelle Sheehan, Anna Katharina Känzig and Yvonne Müller.

At the end of August, I was able to spend some of the most beautiful days of the research time when Michael and Nikolaus Kropac visited Khatgal. They both made my stay in Khatgal much more special.

This is also the place to thank my parents wholeheartedly. They have always believed in me, and have always let me go; I am grateful beyond expression for this.

But my most special thanks go to Michael Kropac: for bringing me to Mongolia in the first place, for believing in my project idea from the minute the idea was born and for his visit in Mongolia this summer. His never ceasing moral support and very valuable scientific input have been a tremendous help that has finally made this thesis into what it is. Thank you for everything.

Basel, November 2007

*Katharina Conradin*

### ***Note to the Reader***

This thesis is closely connected to the two theses written by Jacqueline von Arx and Oyunmunkh Byambaa, who were part of the research team in Khatgal in summer 2007. Both theses will be available in spring 2008.

- For more information on the nature space and the geo-ecology of the Khuvsgul area, refer to: VON ARX, J. (2008): Geo-Ecological Research in the Khuvsgul Area, Northern Mongolia. Master Thesis (in German). Department of Geosciences, University of Basel.
- For more information on tourism management and water pollution problems, see B. Oyunmunkh's thesis: OYUNMUNKH, B. (2008): Ecological Vulnerability on the Western Shoreline of Lake Khuvsgul, Khuvsgul National Park. Master Thesis (in English). Mongolian Landscape Research Centre, National University of Mongolia, Ulaanbaatar.

**Contents – Overview**

1	INTRODUCTION _____	1
2	CONTEXT: FRAMEWORK FOR THE PROVISION OF ADEQUATE SANITATION _____	9
3	ECOSAN _____	16
4	PROCEDURE AND METHODOLOGY _____	37
5	RESEARCH AREA _____	49
6	KHUVSGUL INN ECOSAN PILOT-PROJECT, KHATGAL _____	56
7	CURRENT WASTEWATER AND WASTE MANAGEMENT _____	62
8	ECOSAN IN KHATGAL _____	68
9	SYNTHESIS _____	110
10	SUMMARY _____	128
11	REFERENCES _____	132
12	APPENDIX _____	140

## Contents

<i>Preface and Acknowledgements</i> .....	<i>iii</i>
<i>Note to the Reader</i> .....	<i>iv</i>
<i>Contents – Overview</i> .....	<i>v</i>
<i>List of Figures</i> .....	<i>ix</i>
<i>List of Photos</i> .....	<i>ix</i>
<i>List of Maps</i> .....	<i>x</i>
<i>List of Tables</i> .....	<i>x</i>
<i>List of Text Boxes</i> .....	<i>xi</i>
<i>Abbreviations and Acronyms</i> .....	<i>xi</i>
<i>Glossary</i> .....	<i>xiii</i>
<b>1 INTRODUCTION</b> .....	<b>1</b>
1.1 Essentials .....	1
1.2 Objectives .....	2
1.3 Core Questions and Hypotheses .....	4
1.4 Relevance.....	5
1.5 Limitations.....	6
1.6 Structure.....	7
<b>2 CONTEXT: FRAMEWORK FOR THE PROVISION OF ADEQUATE SANITATION</b> .....	<b>9</b>
2.1 Adequate Sanitation .....	9
2.1.1 <i>Access to Sanitation in Mongolia</i> .....	11
2.2 Provision of Sanitation Services in Mongolia.....	12
2.2.1 <i>Institutional Framework</i> .....	12
2.2.2 <i>Climate</i> .....	13
2.2.3 <i>Water Resources</i> .....	13
2.2.4 <i>Settlement Patterns</i> .....	14
<b>3 ECOSAN</b> .....	<b>16</b>
3.1 Current Wastewater Management Concepts.....	16
3.1.1 <i>Development of Current Wastewater Management Concepts</i> .....	16
3.1.2 <i>Drawbacks of Current Wastewater Management Concepts</i> .....	16
3.2 Ecological Sanitation .....	21
3.2.1 <i>Characteristics of Different Flow Streams</i> .....	21
3.2.2 <i>Ecosan Concept</i> .....	23
3.2.3 <i>Advantages of Ecosan</i> .....	24
3.2.4 <i>Challenges for Ecosan</i> .....	27
3.3 Mongolia and Ecosan .....	28
3.3.1 <i>Rationale for the Implementation of Ecosan in Mongolia</i> .....	28
3.3.2 <i>Limitations for the Implementation of Ecosan in Mongolia</i> .....	32
3.4 Existing Ecosan Projects in Mongolia .....	34
3.4.1 <i>Norwegian Lutheran Mission Ecosan Toilet Programme</i> .....	34
3.4.2 <i>GTZ Ecosan Pilot Projects in Ulaanbaatar</i> .....	35

<b>4</b>	<b>PROCEDURE AND METHODOLOGY</b>	<b>37</b>
4.1	Procedure .....	37
4.2	Theoretical Framework .....	39
4.2.1	<i>Qualitative Research</i> .....	39
4.2.2	<i>Quantitative Research</i> .....	39
4.2.3	<i>Considerations for Qualitative and Quantitative Research</i> .....	40
4.3	Qualitative Methods .....	41
4.3.1	<i>Semi-Structured Interviews</i> .....	41
4.3.2	<i>Participatory Research: Community Meetings</i> .....	43
4.3.3	<i>Expert Interviews</i> .....	45
4.3.4	<i>Participant Observation</i> .....	45
4.4	Quantitative Methods .....	45
4.4.1	<i>Tourists' Questionnaire</i> .....	46
4.4.2	<i>Lodges' Data</i> .....	46
4.5	Methods and Procedure for the Trial Garden.....	46
4.5.1	<i>Layout</i> .....	47
4.5.2	<i>Fertilization and Irrigation</i> .....	48
4.5.3	<i>Documentation</i> .....	48
<b>5</b>	<b>RESEARCH AREA</b>	<b>49</b>
5.1	Physiogeographical Aspects.....	50
5.2	Socio-Cultural Aspects .....	53
<b>6</b>	<b>KHUVSGUL INN ECOSAN PILOT-PROJECT, KHATGAL</b>	<b>56</b>
6.1	Design .....	56
6.2	Cost .....	59
6.3	Concept .....	60
6.4	Problems and Suggestions for Improvement.....	61
<b>7</b>	<b>CURRENT WASTEWATER AND WASTE MANAGEMENT</b>	<b>62</b>
7.1	Lodges' Current Sanitation Technologies .....	62
7.1.1	<i>Regulatory Framework</i> .....	62
7.1.2	<i>Current Practices</i> .....	62
7.1.3	<i>Problems Resulting from Current Practices</i> .....	64
7.2	Local People's Current Sanitation Technologies .....	65
7.3	Current Solid Waste Management.....	66
<b>8</b>	<b>ECOSAN IN KHATGAL</b>	<b>68</b>
8.1	Lodge Owners and Ecosan .....	68
8.1.1	<i>Awareness of Environmental Problems</i> .....	68
8.1.2	<i>Problems with Current Sanitation Systems</i> .....	69
8.1.3	<i>Attitudes towards Ecosan: Advantages</i> .....	70
8.1.4	<i>Attitudes towards Ecosan: Disadvantages</i> .....	72
8.1.5	<i>Organisation and Maintenance of Ecosan Toilets</i> .....	73
8.1.6	<i>Preconditions and Support</i> .....	74
8.1.7	<i>Acceptance of Reuse Concepts</i> .....	75
8.2	Tourists and Ecosan .....	76
8.2.1	<i>Demographic Aspects</i> .....	76
8.2.2	<i>Survey Biases</i> .....	76

8.2.3	<i>Awareness of Environmental Problems</i> .....	77
8.2.4	<i>Importance of Environmentally Friendly Sanitation Technologies</i> .....	78
8.2.5	<i>New Ecosan Urine-Diversion Toilet at Khuvsgul Inn</i> .....	80
8.2.6	<i>Ecosan Concept</i> .....	81
8.2.7	<i>Advantages and Disadvantages of the Ecosan Toilet in Khuvsgul Inn</i> .....	82
8.2.8	<i>Acceptance of Reuse Concepts</i> .....	84
8.2.9	<i>Legal Framework for Ecosan</i> .....	85
8.2.10	<i>Other Measures to Protect the Environment</i> .....	86
8.3	<b>Local Population and Ecosan</b> .....	87
8.3.1	<i>Awareness of Environmental Problems</i> .....	87
8.3.2	<i>Influences of Tourism in the Lake Khuvsgul Area</i> .....	93
8.3.3	<i>Problems with Current Sanitation Systems</i> .....	95
8.3.4	<i>Attitude towards Ecosan</i> .....	97
8.3.5	<i>Ecosan in Winter</i> .....	98
8.3.6	<i>Acceptance of Reuse Concepts</i> .....	99
8.4	<b>Trial Garden</b> .....	103
8.4.1	<i>Alfalfa</i> .....	105
8.4.2	<i>Barley</i> .....	106
8.4.3	<i>Oats</i> .....	107
8.4.4	<i>Natural Vegetation</i> .....	108
8.5	<b>Intermediate Conclusion</b> .....	109
<b>9</b>	<b>SYNTHESIS</b> .....	<b>110</b>
9.1	<b>Discussion</b> .....	110
9.1.1	<i>Natural Framework Conditions</i> .....	110
9.1.2	<i>Legal and Institutional Framework</i> .....	110
9.1.3	<i>Social Acceptance</i> .....	111
9.1.4	<i>Operation and Maintenance</i> .....	112
9.1.5	<i>Economic Factors</i> .....	114
9.1.6	<i>Sustainability of Reuse Concepts</i> .....	116
9.2	<b>Conclusion</b> .....	121
9.3	<b>Recommendations</b> .....	124
<b>10</b>	<b>SUMMARY</b> .....	<b>128</b>
<b>11</b>	<b>REFERENCES</b> .....	<b>132</b>
11.1	<b>Print Sources</b> .....	132
11.2	<b>Internet Sources</b> .....	139
<b>12</b>	<b>APPENDIX</b> .....	<b>140</b>



## List of Figures

Fig. 1:	Transmission routes for faecal-oral diseases .....	10
Fig. 2:	Access to improved sanitation in Mongolia.....	11
Fig. 3:	Alignment of conventional “flush-and-discharge” sanitation systems .....	17
Fig. 4:	Contribution of urine, faeces and greywater to nutrients in wastewater .....	22
Fig. 5:	Ecosan – a loop based approach .....	23
Fig. 6:	Structure of the research partnership .....	38
Fig. 7:	Layout and fertilizing plan for trial garden.....	47
Fig. 8:	Newly established lodges per year in the Lake Khuvsgul area since 1987 .....	54
Fig. 9:	Front view of the toilet at Khuvsgul Inn (plan).....	56
Fig. 10:	Back view of the toilet at Khuvsgul Inn (plan) .....	57
Fig. 11:	Cross section of the toilet at Khuvsgul Inn.....	57
Fig. 12:	Side view of the toilet at Khuvsgul Inn (plan).....	58
Fig. 13:	The ecosan loop for Khatgal.....	60
Fig. 14:	Improved faeces storage container .....	61
Fig. 15:	Importance of environmentally friendly technologies.....	78
Fig. 16:	Willingness to pay more for a lodge with environmentally friendly technology ....	79
Fig. 17:	Tourists’ rating of the design, hygiene, smell and user comfort of the new ecosan UDD toilet .....	80
Fig. 18:	Reasons for introducing ecosan to the Khuvsgul area, tourists’ evaluation.....	82
Fig. 19:	Biggest advantages of ecosan, tourists’ evaluation.....	83
Fig. 20:	Biggest disadvantages of ecosan, tourists’ evaluation .....	84
Fig. 21:	Accepted products fertilized with sanitised human excreta, tourists’ evaluation..	85
Fig. 22:	Measures to protect the environment, tourists’ suggestions.....	86
Fig. 23:	Rich picture/influence diagram on human impacts on the environment .....	92
Fig. 24:	Rich picture/influence diagram on impacts of tourism .....	94
Fig. 25:	Problem tree on sanitation.....	96
Fig. 26:	Advantages and disadvantages of ecosan, first community meeting .....	101
Fig. 27:	Advantages and disadvantages of ecosan, second community meeting .....	102
Fig. 28:	“Aerial view” of the trial garden after ten weeks of growth.....	104
Fig. 29:	Alfalfa, oats and barley after ten weeks of growth .....	104
Fig. 30:	Individual fertilized and non-fertilized plants after ten weeks of growth.....	105

## List of Photos

Photo 1:	The NLM toilet with a squatting pan .....	34
Photo 2:	Storage chamber below the NLM toilet.....	34
Photo 3:	Outside view of the GTZ ecosan toilet in Ulaanbaatar .....	36
Photo 4:	View of the GTZ toilet from inside.....	36
Photo 5:	Assembling of the GTZ toilet .....	36
Photo 6:	Interview with a lodge owner .....	42
Photo 7:	Guided tour to the toilet .....	43
Photo 8:	Participants of the first community meeting drawing a map .....	43
Photo 9:	Forests on north slopes of mountains.....	51
Photo 10:	Alpine meadow surrounded by larch .....	51

Photo 11: Front view of the ecosan toilet .....	58
Photo 12: Back view of the ecosan toilet .....	59
Photo 13: Back view of the ecosan toilet, close-up .....	59
Photo 14: Separating seat.....	59
Photo 15: Toilet cubicle .....	59
Photo 16: “Flushing“ with ash.....	59
Photo 17: Wastewater truck .....	63
Photo 18: Water transport in Khatgal .....	63
Photo 19: Emptying of greywater in existing pit latrines.....	64
Photo 20: “Road” at the western shore of Lake Khuvsgul.....	65
Photo 21: Tilted pit toilet.....	66
Photo 22: Kharagana waste dump south of Khatgal .....	67
Photo 23: Solid waste disposal site in Jankhai .....	67
Photo 24: Ger camp at Lake Khuvsgul .....	68
Photo 25: Logging in Jankhai.....	69
Photo 26: Outside plumbing.....	70
Photo 27: Waste dump within the village of Khatgal .....	88
Photo 28: Waste dump in an old building in Khatgal.....	88
Photo 29: Old toilet at campsite north of Khatgal .....	90
Photo 30: Campsite north of Khatgal .....	90
Photo 31: Current campsite toilet.....	90
Photo 32: Individual alfalfa plants .....	105
Photo 33: Individual barley plants .....	106
Photo 34: Individual oat plants .....	107
Photo 35: Individual grasses .....	108
Photo 36: Locally made urine-diversion toilet .....	115
Photo 37: Sea Buckthorn ( <i>Hippophae Rhamnoides</i> ) .....	117
Photo 38: Farmland in Selenge aimag.....	118

### **List of Maps**

Map 1: Land degradation in Mongolia and types of pressure .....	31
Map 2: General map of Mongolia .....	49
Map 3: Topographical map of the Lake Khuvsgul area .....	50
Map 4: Map of the research area.....	52
Map 5: Research area and tourist infrastructure .....	55
Map 6: Community map of Khatgal .....	89
Map 7: Community map of the camping area north of Khatgal .....	89

### **List of Tables**

Table 1: Analysis of alfalfa growth in different test plots .....	106
Table 2: Analysis of barley growth in different test plots.....	107
Table 3: Analysis of oat growth in different test plots .....	108
Table 4: Analysis of the growth of the natural vegetation in different test plots.....	108

Table 5: Advantages and disadvantages of professional and private management of ecosan toilets.....	113
---	-----

## **List of Text Boxes**

Box 1: Adequate sanitation...?	10
Box 2: The different colours of wastewater.....	17

## **Abbreviations and Acronyms**

ADB	Asian Development Bank
AIACC	Assessments of Impacts and Adaptations to Climate Change, a joint project of START, the Third World Academy of Sciences, and the UN Environment Programme UNEP
BUWAL	Bundesamt für Umwelt, Wald und Landschaft (Swiss Federal Agency for the Environment, Forests and Landscape)
CHF	Swiss Franc
CIA	Central Intelligence Agency of the United States of America
cm	Centimetre
e.g.	exempli gratia (Latin: for example)
EAWAG	Eidgenössische Anstalt für Wasserversorgung, Abwasserreinigung und Gewässerschutz (Swiss Federal Institute of Aquatic Science and Technology)
ecosan	Ecological Sanitation
ecosanres	Ecological Sanitation Research, a Swedish research programme administered by the Swedish International Development Cooperation Agency (Sida) and the Stockholm Environment Institute (SEI)
etc.	et cetera (Latin: and so forth)
€	Euro
f.	following page
ff.	following pages
Fig.	Figure
ibid.	ibidem (Latin: at the same place)
EU	European Union
GoM	Government of Mongolia
GTZ	German Agency for Technical Cooperation
JMP	The WHO and UNICEF Joint Monitoring Programme for Water Supply and Sanitation
i.e.	id est (Latin: that is)
IHP	International Hydrological Programme of the United Nations Educational, Scientific and Cultural Organisation
Int.	International

L	Litre
m	Metre
mm	Millimetre
Mio.	Million
MNT	Mongolian Tugrik (Mongolian Currency). As of November 2007, 1€ equals roughly 1700 MNT, 1 CHF equals roughly 1010 MNT)
MOFA	Mongolian Organic Farmer's Association
n	Sample Size
NBC	National Board for Children, Mongolia
NGO	Non-Governmental Organisation
NLM	Norwegian Lutheran Mission
N.P.	National Park
NSOM	National Statistical Office of Mongolia
Q	Question (to denominate the question number in chapter 8.2)
s.l.	sine loco
s.n.	sine nomine
SDC	Swiss Agency for Development and Cooperation
SPSS	Statistical Package for the Social Sciences (SPSS Inc.)
STC	Safe the Children, UK based NGO
SVGW	Schweizerischer Verein des Gas- Und Wasserfaches (Swiss Swiss Gas and Water Industry Association)
t	Ton
UN	United Nations
UDD Toilet	Urine-Diversion Dehydration Toilet, used synonymously with urine separation toilet, or no-mix toilet
UNDP	United Nations Development Programme
UNESCO	United Nations Educational, Scientific and Cultural Organisation
UNICEF	United Nations Children's Fund
URL	Uniform Resource Locator (World Wide Web address)
VIP Latrine	Ventilated Improved Pit Latrine
WHO	World Health Organisation
w/o	without

## Glossary

Aimag	Political and administrative unit equivalent to province.
Bagh	Lowest political and administrative unit, equivalent to community.
Blackwater	Blackwater is a mix of urine and faeces and can additionally be combined with flushwater from toilets. In contrast to sewage or wastewater, it does not contain the general greywater from the household. It contains all nutrients excreted, but also a high number of pathogens. The volume depends on the sanitation system (dry, flush).
Brownwater	Brownwater refers to pure faeces, or faeces mixed with flushing or anal cleansing water. Brownwater does not contain urine. Most of the pathogens are contained in this fraction. Faecal matter is rich in phosphorous, potassium and organic matter (JÖNSSON ET AL. 2004: 32). The amount of faeces varies (depending on the digestibility of the diet) from about 55 kg per person/year (KVARNSTRÖM ET AL. 2006: 3 and JÖNSSON ET AL. 2004: 5) to 190 kg per person/year (PIEPER 1987 IN JÖNSSON ET. AL 2004: 7)
Ecosan fertilizer	Fertilizer produced from sanitised human excreta from ecosan toilets.
Ger	In Mongolian, ger simply means home. Gers, or yurts, are traditional dwellings that consist of a wooden framework and a felt and cloth cover. The wooden framework includes foldable, lattice-like walls, long poles, a round smoke escape and its supports. The floor of the ger consists of wood, carpet, plastic, or simply pounded earth. The number of walls and poles determines the size of the ger. Most herder's gers have five walls, which make a living area of 16 to 18m <sup>2</sup> . In the centre of the ger stands the hearth, which is both used for heating and cooking. Gers weigh approximately 200 to 250 kg. It takes only little time to collapse and rebuild this traditional nomad's dwelling.
Ger areas	Ger areas are the informal settlements on the outskirts of cities in Mongolia, usually the first living quarters of rural immigrants. They are not necessarily illegal; e.g., any person moving into the capital city is entitled to an area of 700 m <sup>2</sup> (MARTI 2007:5). The individual compounds are separated by wooden fences and usually consist of one or several gers and a latrine. Ger areas are notoriously underserved and lack public infrastructure. Ger district is used as a synonym for ger areas.
Ger camp	In this study, "ger camp" denominates the rather upmarket lodges where tourists sleep in private gers. Ger camps usually contain a central administration building, a restaurant and a toilet/shower house. Instead of in a hotel room, the tourists sleep in private gers that generally include between two and five beds and a stove (see also Guesthouse).

Greywater	Greywater is only slightly polluted wastewater from dishwashing, showers, laundry machines, and sinks etc. It is normally not contaminated with faecal bacteria. Greywater makes up for the largest share of wastewater.
Guesthouse	A guesthouse is a smaller, usually lower-price accommodation. In spite of its name, tourists usually sleep in gers (if in the countryside), but the gers are normally shared with other tourists. The services offered are less exclusive than in ger camps.
Lodge	Lodge is used as a general term for a tourist accommodation; it includes both ger camps and guesthouses (see above).
Open pit latrine	An open pit latrine consists of a pit without any kind of lid or superstructure or seal that prevent vectors from coming in contact with excreta.
Pour-flush latrine	A pour-flush latrine is a latrine with a siphon: after each use, water is poured in the bowl. The resulting water seal creates a barrier between the excreta and the environment.
Simple pit latrine	A simple pit latrine consists of a pit with a superstructure or a lid that prevents vectors from getting in contact with excreta. Pit latrines are dry systems.
Soum	Political and administrative unit equivalent to county.
Ventilated improved pit latrine (VIP Latrine)	The design of a ventilated improved pit (VIP) latrine is very similar to that of a simple pit latrine, but it additionally contains a pit cover slab and a ventilation pipe with a fly screen. The cover slab prevents vectors from coming into contact with faeces. The pipe shall increase the air flow and reduce smell. Though a VIP toilet is not always lined in reality, the term is here used for latrines with lined collection pits.
Yellowwater	Yellowwater is either urine diluted with flushwater or pure urine. Urine contains most of the nutrients that are excreted again, but only has a very low, if at all, pathogen count. According to LIENERT & LARSEN (2006: 4838), urine amounts to less than 1% of domestic wastewater, but it typically contains 80% of nitrogen and 50% of excreted phosphorus (LARSEN ET. AL 2001: 193A). However, micro-pollutants (e.g. from medication) or endocrine substances are also excreted through urine. The total amount of urine per person per year is about 550L (KVARNSTRÖM ET AL. 2006: 39).

# 1 INTRODUCTION

Mongolia is historically famous for its clean air, pure freshwater streams and its low population density. Through their nomadic lifestyle, Mongolians have established a very close relationship to and a great respect for nature. Water is considered sacred and must not be defiled. While a healthy environment is vital for many Mongolians who still live nomadically, nature is also becoming increasingly important as a resource for tourism. But the pristine nature is increasingly under pressure both in large urban settlements, mining sites, and through tourism.

And, though Mongolia is a scarcely populated country, the lack of adequate sanitary infrastructure does not remain without consequences. On the one hand, there are water shortages, polluted groundwater resources and high incidents of gastro-intestinal diseases in the cities. On the other hand, there is a growing tourism industry that is slowly degrading the only real resource for tourism that there is: the vast and pristine landscape. Not much thought has yet been given to finding adequate and sustainable solutions that respect the specific lifestyle and culture of Mongolians and protect the environment.

## 1.1 Essentials

The Mongolian situation is a reflection of the worldwide conditions. Globally, more than 2.6 billion people lack access to adequate sanitation. This plain statistical fact has grave consequences: Together, unclean water and poor sanitation are the world's second biggest killer of children. Six times more people died from diarrhoea in 2004 than were killed, on average, in armed conflicts in one year in the 1990s (UNDP 2006: 6). But lacking sanitation does not only cause human loss, but also "massive economic waste, [such as] costs associated with health spending, productivity losses and labour diversions" (IBID.: 6). In addition, lack of sanitation and the subsequent dealing with wastewater are also an issue of environmental pollution.

However, this situation is not going to be changed sustainably if linear, waste-based end-of-pipe solutions are continued to be regarded as the only solution. Conventional sewer-based systems where all different waste streams are mixed, collected centrally and then (hopefully) treated in a wastewater treatment plant at the end of the pipe are not only enormously difficult and expensive to implement, they are also mostly unaffordable for poorer countries. Additionally, these approaches result in a waste of nutrients worth billions of dollars every year (UNESCO/IHP & GTZ 2006: 9). In order to improve sanitation coverage worldwide, and in order to minimise the negative effects that are inflicted on the environment with current wastewater practices, a fundamentally new approach is needed. It is essential to get away from considering wastewater a waste; it should instead be regarded as a resource. One of the approaches that do this is called ecological sanitation, or ecosan for short. It deems all the fractions that are termed wastewater beneficial for other purposes. It favours de-centralised and locally adapted concepts for wastewater management and minimises the negative impacts of lacking or improper sanitation both on the health and dignity of its users as well as on the environment.

Ecosan options have been practised since the early 1990s. However, most inexpensive low-tech options have been implemented in tropical countries, while generally, more sophisticated systems have been operated in northern countries. There are few experiences on low-tech ecosan options in temperate or even continental climates with long and cold winters; there are also hardly any experiences with ecosan in countries without an agricultural tradition. As for the special case of Mongolia, there were next to no experiences in 2007, both in terms of design and in terms of the acceptance of the reuse-based ecosan concept in a non-agrarian society.

This thesis focuses on filling at least one of these gaps. While it contains some recommendations on climate-adapted design of ecosan toilets, it concentrates specifically on the acceptance of the reuse-based ecosan concepts in Mongolia, and presents various alternatives for recycling in a traditionally pastoral society.

The need for new approaches is great – be it in the capital city of Mongolia, Ulaanbaatar, where thousands of newcomers move into the ger areas at the outskirts of the city every year and where no infrastructure whatsoever is provided to them; or be it in tourist areas, where an increasing number of visitors cause environmental degradation and pollution.

This thesis concentrates on the latter aspect by analysing the acceptance of ecosan on the basis of an ecosan pilot project in a tourist lodge in the Lake Khuvsgul<sup>1</sup> area in northern Mongolia. In a holiday visit to the area in the year 2006, the need for better and more sustainable sanitation options was recognized. Consequently, a pilot project was developed and planned in cooperation with Kent Madin, co-owner of the Khuvsgul Inn in Khatgal, the village at the southern end of Lake Khuvsgul and centre of the local tourism industry. In summer 2007, the pilot model of the toilet was built, operated and monitored. A number of in-depth interviews, community meetings, guided tours to the toilet and the adjoining trial garden, tourist interviews and countless conversations with local people and officials supply the data for the present thesis.

## 1.2 Objectives

So far, only little thought has been given to whether ecosan could be an option for tackling the sanitation problems in Mongolia, and to what specific adaptations of the concept would be necessary to successfully implement ecosan projects in Mongolia. It is an often-heard argument that in such a vast country – Mongolia is nearly five times as big as Germany – there are bigger problems than the excreta of some 3 million people. However, those who make this argument neglect that Mongolia is not uniformly scarcely populated, but faces the effects of a very high local concentration of people in a very small part of the country as other countries do; and that most ecosystems in Mongolia are extremely fragile. The need for more specific information about sanitation problems and acceptable options in Mongolia is great;

---

<sup>1</sup> As Mongolia uses Cyrillic letters, which cannot always be translated unequivocally to Roman Script, the spelling for place names varies widely. Khuvsgul is also spelled Khovsgol, Hovsgol, Huvsgul, Chubsgul, Hövsgöl etc., Khatgal also Hatgal, and Muren also Mörön. Khuvsgul, Khatgal and Muren were chosen because they convey the pronunciation of the word in Mongolian best, and because they do not contain any special characters. However, in the References, the original writing was kept.



this is also mentioned in a preceding study on sanitation facilities for Mongolia (LINDBLOM 2006: 57).

Thus, this study principally aims at assessing the feasibility of ecological sanitation projects in the Lake Khuvsgul area in northern Mongolia and hence at demonstrating an alternative option to conventional wastewater management approaches. Though the pilot project and the survey were conducted in the Khuvsgul area, the results will be in part transferable to other regions in Mongolia.

The main goal of this thesis is to **advance and adapt the ecosan concept to the specific socio-cultural and natural-spatial conditions found in northern Mongolia** by assessing the feasibility of the concept and identifying problems, opportunities and specific needs for adaptation of already existing ecosan concepts.

- A second particular focus lies on **determining the cultural acceptability of ecosan technologies**. The study differentiates between the three main stakeholder groups: operators in the tourism sector, visiting tourists and the local population. The thesis consequently allows planners to judge the acceptance of ecosan more accurately.
- A specific focal point is the **acceptability of different nutrient reuse options**. The study evaluates the various acceptable reuse concepts and their respective sustainability in terms of ecological suitability, economical aspects and social acceptance. The results should hopefully prevent failures of reuse concepts due to cultural reasons.
- In order to **demonstrate the fertilizing effects of the urine**, a small trial garden was established to monitor the growth and development of the different species and their response to different doses of fertilizer and water. This supporting part of the theses<sup>2</sup> additionally served as a demonstration ground for visitors and the local population to visualise the effects of urine fertilization.
- A further goal of the study was to **address the issue of potential contamination of the lake through wastewater**. The ecosan concept can show a relatively easy and low-cost ways of preventing water pollution. Though the problem is recognized by the local Khatgal government, the National Park authorities, tourism operators and local inhabitants, there is currently a lack of alternatives in dealing sustainably with wastewater. This thesis aims at heightening the awareness and knowledge of ecologically, economically and socially sustainable alternatives.
- In a broader sense, the thesis aims at **investigating the adaptability of the ecosan concept in an area where agriculture has not been practised historically**. Through a sensible choice of crops and plants (e.g. wood, animal fodder or non-root crops) in the trial garden, it is examined to what extent the reuse of urine and faeces as a fertilizer would also be feasible in a culture where arable farming does not have a longstanding tradition.

---

<sup>2</sup> Including J. von Arx's thesis.

- Furthermore, the results of this study shall **contribute towards a sustainable tourist development in the area**: Tourists are an important factor to create income possibilities and strengthen the local economy. However, they should not be a burden to the environment and threaten the basis for life of the local population. By first incorporating ecosan systems at tourist lodges, this issue could be addressed, and tourism, the basis of which is the pristine nature in this area, could become more sustainable in an environmental, economic, and social way.
- This study furthermore has the aim to **serve as a reference for decision makers by explaining to them a sustainable and easily adaptable solution**.

The results of this study ease the planning of future ecological sanitation projects in the Khatgal area in particular and Mongolia in general. Indeed, the assessment of this baseline data is of pivotal importance for any further ecosan projects in this country.

### 1.3 Core Questions and Hypotheses

Based on the objectives described above, the main question addressed by this thesis is: **in how far could ecosan be a suitable alternative to conventional wastewater management in the Khatgal area, and what particular characteristics and features would have to be considered in order to adapt ecosan to the specific socio-cultural and nature-spatial framework conditions?** This includes the focus on following questions.

#### **(1) What are the different user groups' (lodge owners, local population and tourists) respective attitudes towards ecosan systems?**

Hypothesis: The interest for new sanitation technologies will be fairly large for lodge owners, as current systems might not be suitable all year round (e.g. flush toilets), or as other problems result (e.g. smell) that are perceived unpleasant for tourists, or as they would like to be able to enter the eco-tourism business. The local people's interest will most likely be contained, as other aspects or problems such as housing or livestock are perceived more important. Tourists will probably appreciate efforts to make tourism more sustainable.

The acceptance for the use of new sanitation technologies depends on the user-friendliness and the comfort of the new toilets; and also on the simplicity of operation and maintenance.

#### **(2) Which options are most suitable – socio-culturally, ecologically and economically – to facilitate the reuse of nutrients contained in human excreta?**

Hypothesis: As Mongolia is a non-agrarian society, and as horticulture is not a common practice in the research area, the acceptance of reusing nutrients from human excreta will be limited. Urine will receive the bigger acceptance than sanitised faeces. Concepts that do not involve food crops for humans or crops that grow above the ground will be most widely accepted. The acceptance of reuse concepts will depend to a large extent on the kind of crops chosen (vegetables, animal forage, wood etc.) and on the way the reuse is organised (centrally or individually).

**(3) What do lodge owners and local people perceive as environmental problems, specifically in relation to water and sanitation?**

Hypothesis: Lake Khuvsgul is still very clean; potential impacts are limited to point sources. However, as the lake is Khatgal's most important asset, and as traditional Mongolian beliefs consider water sacred, people will have given thought to potential impacts of tourism, and the lake will most likely be at the centre of their attention.

**(4) What are the effects of different amounts of urine fertilizer and water given to the test plots in the trial garden?**

Hypothesis: It is assumed that the trial plants will react both to fertilization and irrigation with an increased growth. The combination of irrigation and fertilization will most likely result in the biggest growth increase.

More general questions in relation to the thesis include:

**(5) In which way could ecosan contribute to a sustainable tourist development in the area?**

Hypothesis: Ecosan can only contribute to a sustainable development if it is used on a larger scale. If ecosan is integrated into the concept of eco-tourism, lodges which participate could not only receive a higher recognition, but could potentially raise their tariffs and thus cover the additional costs for the implementation and maintenance of environmentally friendly sanitation technologies.

**(6) Is ecosan with its reuse based concept also feasible in non-agrarian societies?**

Hypothesis: Ecosan is only feasible in Mongolia if reuse concepts are adapted to the Mongolian culture. While concepts that involve the direct reuse for food crop production will receive limited recognition, the use of ecosan fertilizer<sup>3</sup> for projects involving non-food crops (e.g. reforestation) or cash crops that can be sold (e.g. sea buckthorn) will most likely be accepted.

## 1.4 Relevance

The results of this study are important for various stakeholders:

- **Agencies dealing with sanitation**: Though Mongolia faces serious problems in relation to sanitation, suitable alternatives are not yet widely known. By analysing and evaluating the ecosan approach in this specific setting in depth, this thesis can give an important input to organisations involved in the provision of sanitary infrastructure, such as government agencies, NGOs, or private charities. If applied sensibly and properly, ecosan could be an approach for dealing with sanitation problems both in urban and remote rural areas in Mongolia.
- **Ecosan community**: The acceptance of ecosan varies widely across regions and cultures. This study can supply crucial knowledge for the planning and implementation of ecosan in non-agrarian societies, or where the reuse of nutrients for food production is limited by other factors. The thesis demonstrates an innovative way for assessing the

---

<sup>3</sup> Ecosan fertilizer: sanitised excreta from ecosan toilets that are reused as fertilizer.

feasibility of planned ecosan projects. Studies that deal with low-tech ecosan approaches in temperate or even continental climates are rare; some aspects of this are also picked up in this thesis.

- **Tourism organisations / infrastructure boards:** Tourism is one of the mainstays of the Mongolian economy. However, far too little has been done until now to really give meaning to the concept of eco-tourism. This study presents results from the lodge owners' perspectives as well as from tourists' responses to ecosan and hence presents tangible and sound arguments for lodge owners to invest more in ecological and sustainable tourism.
- **Environmental organisations:** Mongolia faces some serious environmental problems, including land degradation and desertification, deforestation, the consequences of mining and dwindling groundwater reserves. If applied on a wider scale, ecosan could present an approach for dealing, at least partly, with these problems, by means of suitable reuse concepts and sustainable water management. For these reasons, it would be good for environmental organisations to look at these issues from a wider perspective – this thesis could be a first step.
- **Local population:** Though not primarily intended to change the local population's behaviour, this study and the related awareness raising activities that were performed during summer 2007 could give local people ideas how existing problems in relation to sanitation could be solved. Ecosan could present a feasible and affordable approach to tackle such problems.

## 1.5 Limitations

### ***Transferability of Data***

The results of the study are to a certain extent transferable to other Mongolian regions. However, through the fact that the study was carried out in the Khuvsgul area, a rural and one of the coldest areas in Mongolia, there are some results that are unique and specific to this particular region, especially what concerns suggestions for reuse concepts or the specific setting of the lodges. Nevertheless, it can be assumed that important aspects such as the acceptance of the concept in general will not vary significantly within Mongolia, and can also be transferred to urban areas. Additionally, the Khuvsgul area is probably one of the most extreme in what concerns climatic feasibility of reuse concepts. Thus, more and easier options might be available in other regions.

### ***Limited Availability of Data***

It was very difficult to find and access already existing data on the sanitation situation in Mongolia. Not much research has been done on this subject, and if there were any accessible publications, they were mostly from international donor agencies. A local view and focus, especially in English, is very rare. This is one of the first, if not *the* first, works on ecological sanitation in Mongolia. The results of this study can therefore not be compared to nor contrasted with other, previous works.

***Time Limitations***

Through the time restrictions inflicted on a master's thesis, it was only possible to extend the field trip to as much as three and a half months to both construct and monitor the pilot project toilet and the trial garden, and to carry out the actual research. Besides, as the toilet is located in a tourist lodge that is only open from June till September, it will not be working in the winter. Though this was not the focus of this thesis, more work would need to be invested into developing an ecosan concept that works year round in the extreme Mongolian climate. The results of the trial garden are limited insofar as the research was only carried out over one vegetation period. Influences such as annual precipitation or temperature changes, as well as the start or the end of the vegetation period, cannot be moderated.

***Cultural Differences***

Though the author has spent a considerable amount of time in the field and has had the chance to visit Mongolia before, cultural differences that inhibit mutual communication and understanding remain. Especially the language aspect was very difficult: it either had to be relied on a translator, or it could only be spoken to people with at least a basic knowledge of English. Direct conversations with all involved stakeholders, especially the local population, were impossible. Though methods were sought where this effect could be minimized (e.g. mutually understandable drawings or pictograms in community meetings), supplementary or auxiliary information is lost in this way.

**1.6 Structure*****Approach to the Topic***

After the introduction in chapter 1, chapter 2 gives an overview of the context of this study: the sanitation situation in Mongolia, and the necessary considerations and specific requirements for the provision of adequate sanitation within this country. Chapter 3 first explains the drawbacks of conventional sanitation and then describes the concept of ecological sanitation to readers who are not familiar with this topic. Additionally, it is analysed how ecosan could present a solution to the specific sanitation problems in Mongolia, but also which potential limitations there are for the implementation of ecosan. The last part of the chapter describes existing ecosan projects within this country.

***Empirical Analysis***

Chapter 4 focuses on the methods used to conduct this study. A short theoretical background is given first, followed by the description of how both qualitative and quantitative methods were used in the research process. The last part of the methodology chapter describes the procedure for the trial garden. Chapter 5 is a short introduction to the research area and includes an overview of the development of tourism in the region, based on own data. Chapter 6 describes the actual research project, the pilot project UDD toilet in Khuvsgul Inn, in depth. The following chapter (7) gives some clarifying information of the current wastewater management in the Khatgal area, both for lodges and local people. Chapter 8 contains the actual analysis of the data collected to evaluate the attitudes towards ecosan systems. It is divided into three parts; the first one focussing on lodges, the second one on

tourists, and the third on the local population. This part is rounded off by a short description of the results of the urine-fertilized trial garden.

***Synthesis***

The synthesis first starts with a general discussion of the results of the acceptance study with the three user groups. This is followed by the conclusion, where closing answers are given to the research questions posted at the beginning of the thesis. At the end, a set of recommendations for further ecosan projects is given.

***Appendix***

In order to allow the interested reader to draw an own conclusion on the attitudes of lodge owners (qualitative analysis), all interviews with lodge owners are attached in Appendix 1. Appendix 2 contains the questionnaire that was used to analyse the tourists' attitude towards ecosan. Appendix 3 includes the questionnaire that was used to collect the quantitative data on lodges, and Appendix 4 lists the participants of the two community meetings. Appendix 5 encloses some information on a reforestation project initiated by J. von Arx and the author.

## 2 CONTEXT: FRAMEWORK FOR THE PROVISION OF ADEQUATE SANITATION

In Mongolia, more than two thirds of the population lack access to adequate sanitation (BATBOLD, TUUN & OYUN (2004: 18). In order to improve this situation and to find feasible and sustainable sanitation practices for this country, a number of specific characteristics or framework conditions – both natural and anthropogenic – have to be considered. Any approach to improve the sanitation coverage in Mongolia needs to take into account not only the limited availability of water resources and the harsh climate, but also anthropogenic factors such as the population density, settlement patterns and behaviours, urbanisation and the existence of previous sanitation systems.

### 2.1 Adequate Sanitation

The UN Millennium Declaration proclaims it a Millennium Development Goal “to halve, by the year 2015, the proportion of people who are unable to reach or to afford safe drinking water [...] and the proportion of people who do not have access to basic sanitation” (UN 2002: 4). The definition of “basic sanitation” should include critical components of what sanitation aims for: privacy, safety, dignity, cleanliness and a healthy environment. Because these aspects are very difficult to measure, a set of indicators to determine the number of people with access to basic (used as a synonym to adequate) sanitation was developed.

The official definition by WHO and UNICEF terms sanitation adequate if it is “improved”. Access to improved sanitation facilities refers to the percentage of the total population using non-shared and non-public

- facilities connected to a public sewer or a septic system
- pour-flush latrines<sup>4</sup>
- simple pit latrines<sup>5</sup>
- ventilated improved pit latrines<sup>6</sup> (WHO/UNICEF JMP 2000: 77).

Open pit latrines (without any kind of superstructure) and bucket latrines or open defecation are always considered unimproved and considered inadequate for the high risk of disease transmission.

The official Mongolian definition vaguely states that sanitation is a “means of collecting and disposing of excreta and community liquid waste in a hygienic way so as not to endanger the health of individuals or the community as a whole” (CIDP 2006: 10). Though the principal understanding remains the same as in the WHO/UNICEF JMP definition, it deems simple pit latrines as inadequate.

<sup>4</sup> A pour-flush latrine is a latrine with a siphon: after each use, water is poured in the bowl. The resulting water seal creates a barrier between the excreta and the environment.

<sup>5</sup> A simple pit latrine consists of a pit with a superstructure or a lid that prevents vectors from getting in contact with excreta. Pit latrines are dry systems

<sup>6</sup> The design of a ventilated improved pit (VIP) latrine is very similar to that of a simple pit latrine, but it additionally contains a pit cover slab and a ventilation pipe with a fly screen. The cover slab prevents vectors from coming into contact with faeces. The pipe shall increase the air flow and reduce smell. Though a VIP toilet is not always lined in reality, the term is here used for latrines where the collection pits are lined

Apart from terming open pit latrines and bucket latrines unsuitable, the official WHO/UNICEF JMP definition remains highly questionable: On-site sanitation systems such as simple pit-latrines and pour-flush latrines can lead to a severe pollution of groundwater resources and can consequently endanger public health. Even “facilities connected to a public sewer or a septic tank system” can have severe drawbacks, especially when considering the fact that only about 10% of the wastewater generated worldwide actually undergoes some kind of treatment (BRISCOE & STEER 1997 quoted in ESREY & ANDERSSON 2001: 36). Also the enormous water and energy use of centralised systems, the resulting pollution of the environment, eutrophication of watercourses and a general waste of resources (see 3.1.2) are not considered. To say it bluntly: these indicators are highly doubtful. Most of the systems termed “improved” by the WHO and UNICEF actually lead to a deterioration in environmental quality, impede the quality of live of those further downstream and endanger drinking water sources (Fig. 1). Few can be termed safe in a hygienic or environmental way.

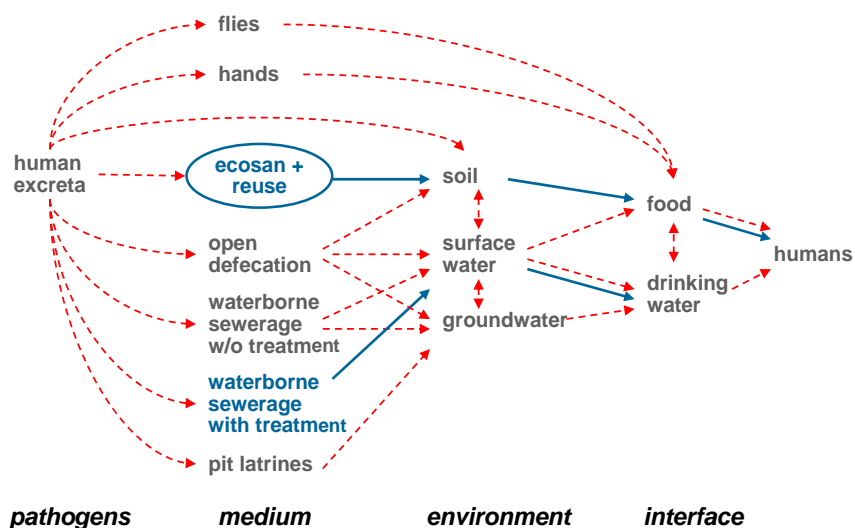

Source: Adapted from BATBOLD ET AL. 2004: 65  
 Graphics: K. CONRADIN

**Fig. 1: Transmission routes for faecal-oral diseases**

When sanitation is inadequate, faecal-oral diseases can be transmitted in various ways: even options considered adequate by the WHO/UNICEF JMP criteria can lead to the transmission of diseases. Red dotted arrows indicate potential transmission routes, while blue arrows show safe ways.

In the end, many of the systems described as “improved” or “adequate” can pose health hazards (Fig. 1) and lead to environmental pollution, since the excreta can either come in direct contact with the environment or are not contained safely, and diseases can be transmitted because a lack of adequate treatment.

**Box 1: Adequate sanitation...?**

In the special case of Mongolia, the definition of adequate sanitation is particularly difficult, as roughly a third of the population (ca. 800'000 people) still live nomadically (SCHENK 2006: 117). While open defecation always has to be considered inadequate from a risk perspective, some nomads use open pit latrines (usually a pit with some boards to squat upon and some kind of a partition) as a sanitation option. These latrines are easily built and still offer some privacy; while the small pit remains, the partition material can be transported to the next grazing area. In this case, human excreta are collected at a central point. Admittedly, there is



a risk in terms of disease transmission through vectors; however, flies are usually only present during some weeks in the summertime. The risk of transmitting diseases through other factors related to sanitation (e.g. not washing hands), is probably much higher. Though inadequate in terms of comfort (especially during wintertime), these “toilets” are, in fact, a reasonably safe option, considering that only a small number of people (usually one family) uses this latrine during some months per year. A precondition is of course that they are built well away from water sources. Nevertheless, according to the abovementioned criteria, these pit latrines are always considered inadequate. In this special case, this is a doubtful classification.

### 2.1.1 Access to Sanitation in Mongolia

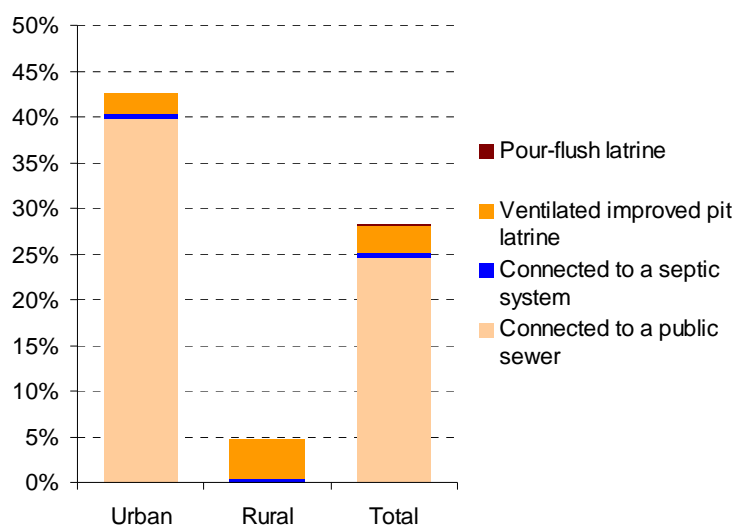

Source: BATBOLD ET AL. 2004: 19

Graphics: K. CONRADIN

**Fig. 2: Access to improved sanitation in Mongolia**

The largest part of those who have access to improved sanitation in urban areas is connected to a public sewer system. This is due to the fact that the main part of the urban dwellers lives in Ulaanbaatar, where there is a centralized sewage system. In rural areas, the largest share of those who have access to improved sanitation uses a ventilated improved pit latrine.

national average.

The situation is very different for urban and rural areas: whereas a total of 42.6% of urban dwellers have access to improved sanitation services, the figure in the countryside is below 5% (IBID: 5). This can be partly explained by the percentage of families who still live nomadically and who often have no latrine at all (see Box 1).

The largest share of those who do have access to improved sanitation lives in cities and has toilets which are connected to a public sewer. This high percentage arises from the fact that most of the urban residents live in Ulaanbaatar<sup>7</sup>, which has a public sewer system. Wastewater treatment plants exist, but their performance has been deteriorating after the downfall of communism. In 2002, only a third of the existing wastewater treatment plants

<sup>7</sup> Officially, the one millionth registered resident of Ulaanbaatar was born in April 2007 (UB Post 2007, Internet). However, it is estimated that the city's population is as high as 1'200'000. This would be almost half of the Mongolia's population.

were functioning at a normal level. (MINISTRY OF INFRASTRUCTURE, NATIONAL WATER COMMITTEE & MINISTRY OF NATURE AND ENVIRONMENT 2003, quoted in WORLD BANK 2004: 18). Of the total 126.4 Mio. m<sup>3</sup> wastewater generated in 2002, only 65.6% was treated to any level, while the rest was discharged without any treatment at all, mostly into surface waters (BASANDORJ, quoted in DORE & NAGPAL 2006: 7).

The second-largest percentage of those who have access to improved sanitation services uses a ventilated improved pit latrine; yet, these are only 2% in urban areas and roughly 4% in rural areas.

There are great disparities in access to sanitation within cities themselves, with those living in apartment buildings having access to better and more infrastructures. Many poorer families who move to the urban areas in search of work just put up their gers at the outskirts of the cities; at the moment, roughly a third of the urban population of Mongolia still lives in yurts (GOM & UNDP 2003: 30ff). The emerging ger areas are notoriously underserved; a quarter of the population living there has no access to any kind waste disposal (IBID.: 30ff.), not to speak of sanitation.

The practice of using simple pit latrines is made worse in Mongolia by the custom of emptying greywater into the latrines in the absence of soak pits. This does not only heighten seepage to the groundwater, but even further augments the bulk of sludge, and slows down the bacterial decomposition process. Furthermore, the practice of adding lime into pit latrines (which raises the pH of the contents and enables a faster decomposition) is discontinued because of its rising costs (IBID.: 18). At least in the countryside, wood or dung ash (which has a similar effect) is still used to cover up the excreta.

The consequences of a lack of adequate sanitation are grave. Due to seepage, the groundwater is polluted, and gastro-intestinal diseases and diarrhoea are still among the leading causes of death for infants (IBID.: 8, 28). Dysentery is the second most-prevalent disease, and Hepatitis rates are seven times the international average (WORLD BANK 2004: 18).

## **2.2 Provision of Sanitation Services in Mongolia**

Improving the access to sanitation is an increasingly pressing issue in Mongolia, considering the high number of unserved people (see 2.1.1), the rapid rate of urbanisation and limited water availability. Very specific framework conditions, such as for instance the extreme climate, the very low population density and lacking infrastructure on the one hand, and the rapid urbanisation on the other hand, make the provision of sanitation more challenging than in other countries.

### **2.2.1 Institutional Framework**

There are a number of institutional constraints that impede the fast and efficient provision of adequate sanitary infrastructure to Mongolians. The responsibilities in the field of sanitation are very poorly defined. In fact, “there is no nationally designated agency that is responsible for planning, implementing, and coordinating efforts on hygiene and sanitation” (CIDP 2006: 11). In addition, the roles of the involved government agencies are not clearly defined, and

the fact that a large number of NGOs are also including sanitation in their lines of action without proper cooperation and coordination further complicates the situation. There is generally a lack of skilled and trained staff, and a limited knowledge of other than conventional sanitation options. In addition, there is also a lack of finances, which restricts progress in the provision of adequate sanitation options (IBID.: 14ff.), mainly because more cost-efficient alternatives or options are not known and therefore not considered

### **2.2.2 Climate**

Mongolia has an extreme continental climate with long, cold, and dry winters and short summers. It is a landlocked country in the heart of continental Asia, far from seas and in the lee of surrounding high mountains – all factors that contribute to a dry climate (BLUNDEN 2004: 9). The annual precipitation ranges from 300 to 400 mm/year in the northern mountainous regions, to a mere 50 to 100 mm/year in the Gobi Desert. About 85% of the rainfall occurs from April until September (BATIMA, NATSAGDORJ, GOMBLUDEV & ERDENETSETSEG 2005: 12), and droughts occur frequently.

The average annual temperatures lie between +8.3°C and -8.3°C. More than 60% of Mongolia surface area lies within the (discontinuous) permafrost zone (BLUNDEN 2004: 4), coinciding with the -2°C isotherm (NATSAGDORJ, quoted in BATIMA, BATNASAN & BOLORMAA 2004: 5). Average temperatures are below freezing from November through March and close to freezing in April and October for most parts of the country. This makes the vegetation period very short: on average, it is about 100 days, but can be well below that in the northern or mountainous areas (BLUNDEN 2004:9). Almost all rivers and freshwater lakes freeze over in the winter; smaller streams commonly freeze to the bottom. The snow cover is normally very thin.

Likewise, climate change is affecting Mongolia; the climate is getting slightly drier and warmer. During the last 60 years, the annual mean air temperature has increased by 1.66°C, with the highest rise in winter. The changes in precipitation have a very localized character; however, the maximum number of consecutive dry days tends to augment in central Mongolia, where annual mean precipitation has decreased (BATIMA ET AL. 2005: 13ff.). In general, “Mongolia’s weather is characterized by extreme variability [...] and the multi-year averages conceal wide variations in precipitation, dates of frosts, and occurrences of blizzards and spring dust storms” (WORDEN & SAVADA 1991: 66). In addition, the rising temperature and uncertainties in rainfall associated with global warming are likely to increase the frequency and magnitude of climate variability and extremes in Mongolia (BATIMA ET AL. 2005: 5).

### **2.2.3 Water Resources**

#### ***Availability***

Water is a scarce resource in large parts of Mongolia; most of the country is arid to semi-arid. According to the Mongolia Environment Monitor (WORLD BANK 2002: 22) “water shortage is one of Mongolia’s major socio-economic and ecological problems that may soon create serious economic problems in several regions throughout the country.” The National Surface Water Survey (AGENCY FOR WATER AND FOREST RESOURCES 2004, quoted in BATBOLD ET AL.

2004: 25) deploras that anthropogenic factors such as the clearing of forests, an inefficient and excessive water use and the predominant use of groundwater result in the degradation of river basin health, change of water flow and discharge regimes and leads to alterations at the ecosystem level with grave loss of flora and fauna diversity. The same report states that since 1995, roughly 12% of the Mongolia's rivers, 15% of its springs, and 18% of its lakes and ponds disappeared (IBID.: 25). Water availability ranges greatly within the country, but in total, only 44.6% of the population have access to improved<sup>8</sup> water sources (BATBOLD ET AL. 2004: 18).

### **Water Use**

Industry consumes the largest share of water (30%), closely followed by water use for livestock (29%). Domestic consumption accounts for 23% of all water used, crop irrigation and silviculture for 9%, and 8% are used for other reasons. Though the abovementioned aspects are definitely reasons for a wiser use of water, large quantities of water are wasted via leaky supply pipes, and urban areas exhibit very high water consumptions rates (MARRIOT 2005a: 8ff.). Apartment dwellers in urban Ulaanbaatar may use almost three times as much water as an average Swiss person: The former use 450 L per person/day (GOM & UNDP Mongolia 2003: 31) compared to 162 L in Switzerland (SVGW & BUWAL 2005, Internet). Flushwater for toilets contribute a significant part to this water use (see also Box 2, p. 17).

### **Quality**

Recent surveys show that the quality of both groundwater and surface water is declining (WORLD BANK 2004: 17). Water quality in rural areas is increasingly threatened by mining activities, while in urban areas the main sources of pollution are the uncontrolled discharge of human and industrial wastes. The Tuul River, flowing through Mongolia's capital, Ulaanbaatar, is "reportedly the most polluted river in the country", and is charged with large amounts of minerals, phosphorus, excessive nitrogen, organic and inorganic wastes, and heavy metal (IBID.: 17). Tourism contributes to a point-wise contamination of water sources.

## **2.2.4 Settlement Patterns**

Mongolia is the country with the lowest population density in the world. In 2006, the population of Mongolia was estimated to be 2.95 Mio. (CIA 2007, Internet). The country has a total surface area of 1'564'116 km<sup>2</sup> (BLUNDEN 2004: 3). This means that the population density is roughly 1.9 people per square kilometre on average. If considering that roughly half of all Mongolians live in Ulaanbaatar, the population density in the countryside is even much lower, on average about 1.1 persons per km<sup>2</sup>. About a third of the total population still lives nomadically or semi-nomadically, away from towns (SCHENK 2006: 117; BLUNDEN 2004: 65), but only about 15% are truly nomadic, i.e., constantly on the move (BLUNDEN 2004: 65).

Yet, the trend towards urbanisation is undeniable. By 2006, 60.2% of the population already lived in urban areas (ADB 2007: 1, Internet). The urban population has been growing at an

<sup>8</sup> According to the WHO/UNICEF JMP (2000: 77), improved water sources include the following: household connection, public standpipe, borehole, protected dug well, protected spring, and rainwater collection. Unprotected wells and springs, vendor-provided water, bottled water and tanker truck-provided water are considered unimproved.

average rate of 4% since 1970 (UNICEF 2007, Internet). In 1990, the population of Ulaanbaatar was about 550'000, not even half of today's estimated 1.2 to 1.3 Million (MARTI 2007:5). Most of the immigrants just take their yurts with them and settle at the outskirts of cities in the notoriously underserved, informal ger areas. Almost 60% of Ulaanbaatar's population live in gers; their number has increased to 90'000 by now (URBANSKY 2007: B3). The rapid urbanisation processes in the late 1990 and after 2000 – coupled with financial and institutional constraints – made it impossible for the government and administration to provide sanitary infrastructure to the immigrants. The result is that now, even in urban areas, less than half of the population has access to sanitation (BATBOLD ET AL. 2004: 19). At the moment, the percentage of those with access to sanitation is probably rather dwindling than rising, as the immigration to the cities remains continuously high.

On the other hand, the very low population density and the nomadic lifestyle of the rural population of Mongolia make the provision of adequate sanitation additionally difficult. Statistically, less than 5% of the rural population had access to improved sanitation in 2004. There are, however, two distinct reasons as to why this problem is not as pressing as the urban situation. Firstly, the Mongolian understanding of adequate sanitation classifies unlined pit latrines as inadequate while they are termed adequate in other conditions (see also discussion Box 1). If they were included as well, a significantly higher number would be classified as having access to adequate sanitation. The figure for rural areas is estimated to be between 29% (WHO/UNICEF JMP 2006, Internet) and 37% (UNICEF 2007, Internet). Secondly, and as mentioned above, the population density is usually very low in the countryside. Though the sanitation options could be improved in most cases, the situation is more pressing in locations with a higher population density.

Given the abovementioned framework conditions, it is clear that conventional, sewer-based and centralised wastewater systems are not the most adapted and adequate solution for Mongolia. Much more, decentralised, individually adaptable solutions, as they are available within the framework of ecological sanitation, are needed.

## 3 ECOSAN

The basic principle of ecological sanitation – ecosan for short – is to regard human excreta and wastewater not as a waste, but as a resource. This view is based on the fact that human excreta still contain significant amounts of nutrients and organic material that are not available to human bodies, but that can be recycled and reused by plants. In this way, ecosan is a loop-based approach that differs fundamentally from the current linear concepts of wastewater management.

### 3.1 Current Wastewater Management Concepts

Present conventional forms of wastewater management and sanitation fall either under the category of conventional waterborne or dry (pit) systems. In both cases, the design is based on the premise that excreta are waste, and that this waste should be disposed of. It is also assumed that the environment can safely assimilate this waste. These assumptions lead to linear flows of resources and wastes and often cause severe environmental pollution. The technological developments that were once designed to solve the sanitation problem have become part of the problem, not the answer to it (ESREY 2000: 30).

#### 3.1.1 Development of Current Wastewater Management Concepts

Wastewater discharge systems that operated with water date as far back as the Roman period; remains of antique wastewater ditches or wooden channels were found in several archaeological sites in Switzerland (ILLI 2005, Internet). However, these systems broke down after the downfall of the Roman Empire, and so human excreta were mostly discharged in pits or ditches in the cities, which led to very unhygienic conditions. The history of modern sewerage dates back to the end of the 19<sup>th</sup> century, when the supply of piped water in cities led to an augmented water consumption and consequently wastewater production. This increased discharge frequently caused the formation of stagnant pools of wastewater in cities and subsequently led to the outbreak of various diseases (e.g. Cholera epidemics). It was thus clear that the water had to be brought out of the cities in some way again. Sewers were developed, and the used water was directed to the nearest river or lake. Interestingly, the introduction of these new sewer systems did not happen without some resistance, as for instance in Zurich, “homeowners were afraid of the cost, and citizens did not want to give their faeces, which they used themselves as fertilizer, away to the city’s authorities” (IBID. 2005). Nevertheless, sewer systems were introduced in most European cities during the late 19<sup>th</sup> century or the beginning of the 20<sup>th</sup> century. This certainly ameliorated the hygienic conditions in the cities themselves, but also increasingly endangered water sources for those further downstream. Yet, it took another 50 years until sewage treatment was introduced on a large scale, and significantly improved the quality of the receiving waterbodies.

#### 3.1.2 Drawbacks of Current Wastewater Management Concepts

Though conventional waterborne sanitation is considered to be a solution for the management of wastewater, it has a number of serious drawbacks:

### **Linear Approach**

Today's conventional wastewater management systems are linear (Fig. 3). Nutrients are taken up by plants, then transported as food to the market and eaten. The nutrients contained in the excreta are flushed away into rivers and eventually into the sea; the sludge from sewage treatment plants, which still contains nutrients, is nowadays burnt and the ashes discarded in hazardous waste deposits or used in road construction. The lack of nutrients in agriculture is made up by applying energy-intensive artificial fertilizers, which are essentially gained from non-renewable resources.

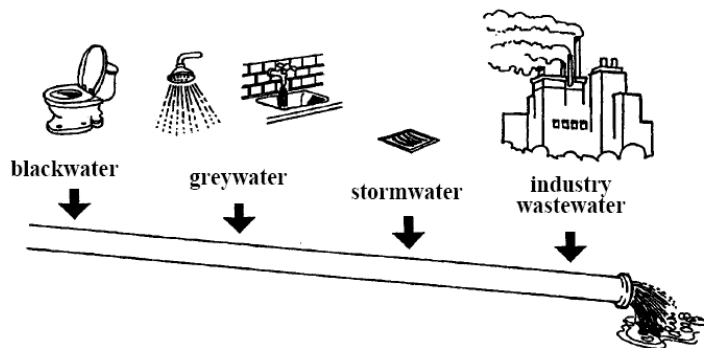

Source: WINBLAD & SIMPSON-HÉBERT 2004: 3

**Fig. 3: Alignment of conventional “flush-and-discharge” sanitation systems**

Conventional sewerage is based on a linear approach. The wastewater that finally arrives at the wastewater treatment plant is a toxic mixture with such diverse characteristics (domestic and industrial wastewater, hospital wastes, rainwater etc.) that overstrain most wastewater treatment plants.

### **Mixing Wastewater Streams with Different Qualities**

Current sewer systems are not able to account for the different qualities of the wastewater they receive. Small and dangerous fractions, such as for instance faeces (containing a large number of pathogens) are mixed with large quantities of water that would generally not require much treatment (e.g. greywater or stormwater, see Box 2). As a consequence, municipalities are forced to build treatment plants with enormously large volumes.

Finding ways of treatment that

consider the characteristics of all different flowstreams (industrial, domestic, medical wastewater) is near to impossible, and hence most streams are only treated partially. Furthermore, the fact that stormwater flows into the sewer system frequently causes sewage treatment plants to overflow in the event of heavy rains: untreated wastewater is then discharged into waterbodies and seriously disrupts aquatic ecosystems.

#### **Box 2: The different colours of wastewater**

**Greywater** is only slightly polluted wastewater from dishwashing, showers, laundry machines and sinks etc. It is normally not contaminated with faecal bacteria. Greywater makes up for the largest share of wastewater. In an average Swiss household, roughly 70% of the household wastewater is greywater (SVGW & BUWAL 2005, Internet).

**Yellow water** is either urine diluted with flushwater or pure urine. Urine contains most of the nutrients that are excreted again, but only has a very low, if at all, pathogen count. According to LIENERT & LARSEN (2006: 4838), urine amounts to less than 1% of domestic wastewater, but it typically contains 80% of nitrogen and 50% of excreted phosphorus (LARSEN ET. AL 2001: 193A). However, micro-pollutants (e.g. from medication) or endocrine substances are also excreted through urine. The total amount of urine per person per year is about 550L (KVARNSTRÖM ET AL. 2006: 39).

**Brownwater** refers to pure faeces, or faeces mixed with flushing or anal cleansing water. Brownwater does *not* contain urine. Most of the pathogens are contained in this fraction; in fact, more than 120 different types of viruses may be excreted in faeces (TAUXE & COHEN 37ff.). Faecal matter is rich in phosphorous, potassium and organic matter (JÖNSSON ET AL. 2004: 32). The amount of faeces varies (depending on the digestibility of the diet) from about 55 kg per person/year (KVARNSTRÖM ET AL. 2006: 3 and JÖNSSON ET AL. 2004: 5) to 190 kg per person/year (PIEPER 1987 in JÖNSSON ET. AL 2004: 7)

**Blackwater** is a mix of urine and faeces and can additionally be combined with flushwater from toilets. In contrast to sewage or wastewater, it does *not* contain the general greywater from the household. It contains all nutrients excreted, but also a high number of pathogens. The volume of blackwater depends on the system that is used to carry the excreta away. While older systems in North America can use up to 20 to 30 L per flush (LANGE & OTTERPOHL 2000: 118), there are systems on the market that use as little as 0.5 to 1.5 L per flush (JENSSEN, GREATOREX & WARNER 2004: 25).

### **Nutrient Recovery**

Most sewage treatment plants do not extract all nutrients from the wastewater. In fact, most plants even in industrialized countries treat the water only up to a secondary stage, i.e. a biological treatment where carbon and nitrogen are partly eliminated. In this stage, bacteria and other microbes remove biodegradable organic matter from the wastewater, thus helping to keep the dissolved oxygen balance of the receiving waters. A third stage, the chemical precipitation of phosphorus, is only practised in more advanced and larger wastewater treatment plants. Further treatments, e.g. the inactivation of micropollutants through UV-radiation, are only in experimental stages. Even after treatment, dissolved nutrients get into the receiving waterbodies, causing further problems downstream. Not only are many rivers and lakes eutrophicated, but the washing away of nutrients, which are all eventually carried into the seas, has led to the formation of so called “dead zones” (zones that have such a low oxygen level that aquatic life cannot be sustained) at the outlets of many big rivers in the world (RALOFF 2004: 360).

Up to the beginning of the 21<sup>st</sup> century, sludge from sewage treatment plants was used in agriculture as a fertilizer, and the nutrient cycle was at least partially closed. However, due to the fact that the sludge had various domestic and industrial sources, it was sometimes greatly contaminated with heavy metals and other dangerous substances. Laws and regulations in most European countries now prohibit the use of sewage sludge on agricultural fields. This lack of nutrients is countered by applying chemical fertilizers. However, their production is energy intensive. Additionally, chemical fertilizers are non-renewable resources<sup>9</sup>. As an example: Estimates on the remaining amount of phosphorus – an essential part of common artificial fertilizers – vary; but all of them agree on the fact that it is a very limited resource. Projections for the amount of time it takes to deplete easily mineable reserves range between 60 to 130 years (STEEN 1998: 25) and a mere 60 to 90 years (TIESSEN 1995: 1). The largest reserves of phosphate rock, the basis for phosphorus, are

<sup>9</sup> With the exception of nitrogen, which can be gained from air.



found in China and Morocco. However, China has drastically reduced its exports in 2005 (ROSEMARIN, quoted in MCCANN 2005: 30).

Artificial fertilizers usually contain only the macronutrients nitrogen, phosphorus and potassium and lack other essential trace elements. This eventually leads to a soil deplete in micronutrients. Fertilizers are bound to world market prices which are already substantially high for many farmers from developing countries. An increase in price, as is to be expected in the case of phosphorus, will make them unavailable for many farmers. This may make agricultural products, especially in developing countries, more expensive and thus lead to a decreased food security.

### ***Lack of Water***

Current sewage systems use a large amount of water; not only for flushing the toilet, but there also has to be a certain minimum water flow to ensure that the gravity operated sewers work. However, water is getting an ever more scarce resource. This is particularly true for cities, where the high concentration of people puts a large pressure on water resources. In 2000, the majority of the sixteen megacities were found [...] within regions experiencing mild to severe water stress<sup>10</sup>; this is particularly true for the cities located on the Asian continent (UN WWAP 2003). According to another UN source, 1.8 billion people will live in countries or regions with absolute water scarcity by 2025, and two thirds of the world population could live under stress conditions (UN-WATER 2006: 2). With growing populations, the pressure on water resources is going to intensify, with the poorest sections of society facing the most severe consequences. Yet, according to the 2006 Human Development Report, “the scarcity at the heart of the global water crisis is rooted in power, poverty and inequality, not in physical availability” (UNDP 2006: 2). In other words: there would be enough water for everyone, if it would be used wisely. Using water to flush toilets is definitely not the most sensible solution.

### ***People without Sanitation***

Today, roughly a third of the world's population lives without access to adequate sanitation (UNDP 2006: 2). Over the next 25 years, 90% of the world's population growth will be absorbed by urban areas in less developed regions (UN HABITAT 2003: xxxi). Given these rapid rates of urbanization, and the mostly unplanned growth of cities in development countries, it is far from realistic that these will all be connected to centralized sewerage. There are not only financial limitations to this, but often, the dense settlement pattern and the illegal construction of buildings make it physically impossible to construct sewerage without destroying most of the settlements themselves. Thus, in order to improve the situation of those without access to sanitation, other, decentralised solutions have to be applied.

### ***Water Pollution***

Though many cities have built sewer systems, they often lack the money or the capacity to build functioning sewage treatment plants: In developing countries, 90% of the sewage is flushed untreated into rivers and lakes; the figure for Latin America is 98% (BRISCOE & STEER

---

<sup>10</sup> “Water stress” is a measure of the amount of pressure put on water resources and aquatic ecosystems by the users of these resources, including the various municipalities, industries, power plants and agricultural users that line the world's rivers, i.e., the ratio of total annual water withdrawals divided by the estimated total water availability (UN WWAP 2003).

1997 quoted in ESREY & ANDERSSON 2001: 36). As a consequence, waterbodies are heavily polluted and pose a great health risk for people dwelling on them.

### ***Micropollutants***

With current sanitation practices, a number of potentially harmful substances are discharged into waterbodies apart from nutrients. One group of substances are the so called micropollutants: residues from pharmaceuticals and synthetic or natural hormones. These substances are mostly excreted in urine. They are currently not or only partially removed in conventional wastewater treatment plants and thereupon get into aquatic ecosystems in the treated wastewater. Micropollutants have shown to have negative effects on aquatic life, such as the change of biological sex in fishes (SIEGRIST ET AL. 2003: 8). Some of these highly persistent substances have already been found in groundwater sources in Switzerland (GALLATI 2007: 20). Centralised, water based systems are often at a lack of dealing with these substances adequately, and additionally face the problem that they have to handle large amounts of wastewater containing only traces of micropollutants (HAMMER & OTTERPOHL 2006: 475).

### ***High Energy Input***

Conventional wastewater treatment plants need relatively high amounts of energy to work, e.g. for aeration, pumping, denitrification etc.. In fact, wastewater treatment accounts for approximately 3% of the electric load in the United States (EPA 2006: 1). For very poor countries, the energy needs for conventional wastewater treatment could accrue to up to 50% of their total energy consumption (LANGE & OTTERPOHL 2000: 243). The energy needed to produce artificial fertilizers to substitute the loss of nutrients in wastewater treatment plants must be considered in addition. Keeping in mind the current debate over global warming, it is pivotal to find less energy-intensive solutions.

### ***Cost***

Centralised and highly technologized conventional wastewater treatment (including pipe networks, treatment facilities etc.) comes at an extremely high cost. Switzerland, as an example, has invested more than 70 Billion CHF in its centralised wastewater treatment system only in the last 30 years (GALLATI 2007: 19). This is an enormously high amount, especially when considering that the extensive pipe network, one of the most expensive parts of the whole system, had then already been built to a large extent. Hence, it is clear that centralised systems are an unaffordable option for most countries where no sewer network whatsoever exists.

### ***Pit Latrines***

Even pit latrines that work without water have some serious drawbacks. The design of these conventional “drop-and-store” pit-latrines mainly aim at infiltrating as much of the liquids to the soil as possible, neglecting the fact that the seepage comprise a high amount of pathogens as well as nutrients (WERNER ET. AL. 2003: 26). These dangerous substances often directly infiltrate into the groundwater, especially in densely populated urban areas with a shallow water table, and pose a significant health hazard to the local population. Though pit latrines could theoretically be emptied, their contents treated and reused, this is hardly done in practice, as it is a highly unpleasant and risky task.

## 3.2 Ecological Sanitation

Ecological sanitation emerged as a response to the abovementioned problems with current wastewater management practices. Ecosan is not a specific technology: the principal idea behind the concept is simply that human excreta are no longer regarded as waste, but as a valuable resource.

First ideas for a new paradigm in sanitation emerged in the 1960s in Sweden, but it took until the 1990s until the concept of ecological sanitation was more widely known. It was recognized that there are some fundamental flaws in current wastewater management concepts. As a result, new approaches in dealing with wastewater were to save water, prevent the pollution of water and reuse the nutrients in human excreta. Furthermore, such new concepts should also pay tribute to the fact that many cities, towns and governments, especially in developing countries, face serious shortages in money and can not afford to build western-style centralised sewer systems for all of their residents. A new way of dealing with wastewater that would improve the environment, while at the same time preventing water-borne diseases from spreading, was needed. This approach is nowadays called ecological sanitation (JOHANSSON 2004: vi).

### 3.2.1 Characteristics of Different Flow Streams

The basic idea of regarding excreta as a resource can be best implemented when the different flow streams are separated. The separated fractions can then be hygienised most efficiently. The following subchapter thus gives a brief insight in the different qualities of the individual fractions, so that the ecosan concept is better understood.

#### ***Urine***

Urine contains the largest amount of the nutrients excreted, but makes up for less than 1% of the domestic wastewater. The total amount of urine per person per year is about 550L (KVARNSTRÖM ET AL. 2006: 39). Research from Sweden shows that more than 80% of the excreta nitrogen and roughly 60% of the excreta phosphorus are found in the urine; the second largest share is found in the faeces. The partitioning of the nutrients between urine and faeces depends upon how digestible the diet is; digested nutrients enter the human metabolism and are excreted with the urine, while undigested fractions are excreted with the faeces (JÖNSSON ET AL. 2004: 7). It can be assumed that the figures for nitrogen and phosphorus are probably about the same in urban settings in Mongolia, but slightly lower in rural areas, as the traditional Mongolian diet with its high intake of milk products and meat, but rather few starch products or sugars, is not overly digestible.

Urine is normally sterile in the bladder of a healthy individual. It may, however, pick up bacteria in the lower part of the urinary tract. If a person is ill, the pathogens excreted may include several kinds of viruses, venereal disease causing organisms, or bacteria. However, except for *Schistosoma* (a parasitic flatworm), which may present a risk in tropical areas where the illness is endemic, the risk for all other diseases to be transmitted through urine is generally low. "The main risks of disease transmission from handling and using human urine are related to faecal cross-contamination of urine and not from the urine itself (SCHÖNNING & STENSTRÖM 2004: 4).

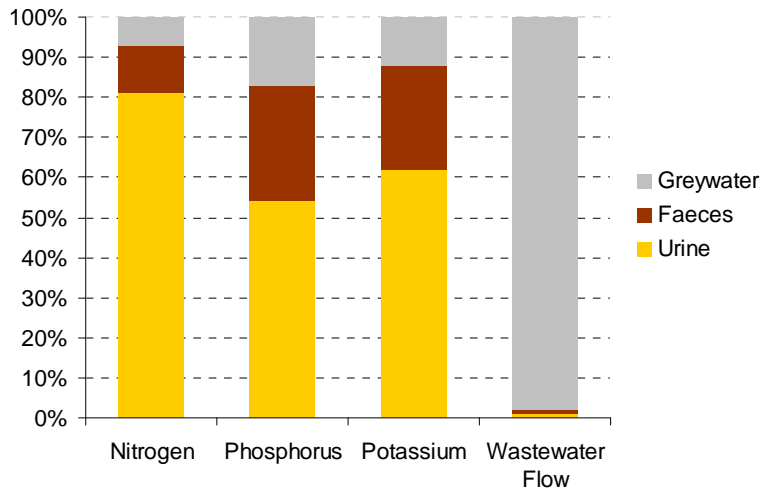

Source: JOHANSSON ET AL. 2000: 9

Graphics: K. CONRADIN

**Fig. 4: Contribution of urine, faeces and greywater to nutrients in wastewater**

As the above graph shows, the majority of nitrogen, phosphorus and potassium is found in urine. Faeces contain considerable amounts of phosphorus and potassium, while both fractions form only a very small part of the total wastewater flow.

Through the contact with faeces, enteric infections can be transmitted by pathogenic species of bacteria, viruses, parasitic protozoa and helminths (SCHÖNNING & STENSTRÖM 2004: 4). Faeces always have to be properly sanitised before they can be reused in agriculture. They contain about 10% of the nitrogen excreted, and roughly each about 30% of the respective phosphorus and potassium; additionally, they too contain about high amounts of organic matter (JÖNSSON ET AL. 2004: 1).

Both urine and faeces contain very low amounts of heavy metals and other contaminating substances such as pesticide residues; the presence of these depends on the amounts present in consumed products (JÖNSSON ET AL. 2004: 7). This is an important advantage over chemical fertilizers: especially phosphorus is often contaminated with various undesirable substances such as radioactive gypsum, arsenic or cadmium (ECOSANRES 2003: 1-2).

### **Greywater**

In a common household, greywater constitutes the largest share of the wastewater. Ecosan systems do not mix this part with excreta, which significantly reduces hygienic and environmental problems related to wastewater management. Exact figures for Mongolia were not available and are very difficult to estimate due to the various lifestyles; however, urban apartment dwellers in Ulaanbaatar use approximately 240 to 450 L of water per person/day (GOM & UNDP Mongolia 2003: 31). Apartment buildings mostly contain flush toilets. If it is assumed that roughly 20 to 40% of the total water consumption of one household is used for toilet flushing (ALSÉN & JENSSEN 2004: 11), this would mean that one person produces between 144 and 360 L of greywater per day. In ger districts, the water amount is about 8 to 10 L per person (NBC, STC & UNICEF 2003: 35), which will, due to the absence of flush toilets, all be greywater.

### **Faeces**

Faeces are the smallest, but the most dangerous fraction of common household wastewater. The amount of faeces varies (depending on the digestibility of the diet) from about 55 kg per person/year (KVARNSTRÖM ET AL. 2006: 3; JÖNSSON ET AL. 2004: 5) to 190 kg per person/year (PIEPER 1987 in JÖNSSON ET AL. 2004: 7).

Faeces hold most of the excreted pathogens. The exposure to untreated faeces is always considered unsafe from a risk perspective.

Greywater contains the lowest amount of nutrients of all wastewater fractions. Yet, it is still slightly polluted and has to be managed in some way. The exact composition of this part of the wastewater varies greatly from place to place, since it reflects the lifestyle of the residents. It frequently contains high concentrations of easily degradable organic matter, e.g. fat, oil and other organic substances from cooking, residues from soap or detergents (RIDDERSTOLPE 2004: 1). It usually comprises low numbers of pathogens and nutrients. If detergents on a phosphate basis are used, greywater may contain relatively high concentrations of phosphorus.

### 3.2.2 Ecosan Concept

Ecosan is an approach based on three fundamental principles: preventing pollution rather than attempting to control it after pollution occurs; sanitising excreta and greywater; and using the safe products for agricultural purposes (WINBLAD ET AL. 2004: 4). Hence, it is a loop-based principle that moves away from linear solutions of waste disposal towards a circular flow of nutrients (ESREY & ANDERSSON 2001: 35). In principle, any system that is founded on this understanding, respecting the following three basic principles, can be called an ecosan system: **1. Do not mix/Contain, 2. Sanitise, 3. Reuse**

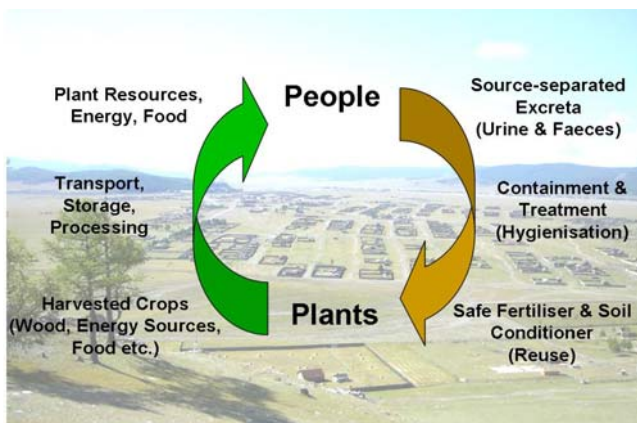

Source: K. CONRADIN

**Fig. 5: Ecosan – a loop based approach**

Ecosan closes the loop between sanitation and plants. Nutrients are sanitised and reused again. In the case of Khatgal, this could e.g. be trees or sea buckthorn.

#### **Sanitise**

The second step is to eliminate the pathogens contained in human excreta, so that a safe and valuable resource which can be used further is produced. Urine that comes from a family environment can be reused directly as a fertilizer (WINBLAD 2004: 9), given that there is at least one month between the application and the consumption. Urine from larger communities can be hygienised by storage; the recommended storage time varies between one and several months depending on the climate and the type of crop to be fertilized (SCHÖNNING & STENSTRÖM 2004: 16). Undiluted storage is preferable, as the naturally high pH in undiluted urine kills more bacteria. New research shows that storage also reduces the presence of micropollutants (STROPMEN ET AL. 2003 in HAMMER & OTTERPOHL 2006: 476).

#### **Do not Mix / Contain**

At a minimum, ecosan systems differentiate between blackwater (i.e., urine and faeces, possibly with flushwater) and greywater. In ecosan systems, human excreta are never directly discharged in communal sewers. While it is a matter of course that excreta has to be contained in order that it can be reused, separation is also necessary because each component of wastewater has different characteristics that can best be dealt with if they are separated, and if they are as concentrated as possible.

There is an array of treatment methods for faeces or blackwater, ranging from simple dehydration toilets to composting toilets or more advanced biogas plants, or aerobic and anaerobic digestion for blackwater. Each of these methods has its individual advantages and drawbacks; the choice for a respective sanitation technology is always highly situation specific. The duration of the respective treatment depends on the method applied. However, the sanitisation of faeces requires much more care than that of urine, as there is a higher risk of disease transmission if faeces are improperly sanitised.

Greywater, which is usually not heavily polluted, can be treated relatively easily, e.g. by gravel filters, constructed wetlands or biofilm procedures.

### ***Reuse***

In order to close the loop and to recycle the nutrients that have been taken from the soil by harvesting plants, the sanitised excreta are reused in ecosan systems. The amount of nutrients humans excrete is almost the same as the one taken up. When humans stop growing, they stop incorporating significant amounts of the nutrients in their bodies. The nutrients are just metabolized and thus no longer available for the human body, but very well so for plants (VINNERÅS & JÖNSSON 2003: 579). The facilitation of small loops (i.e., on a household basis) is usually more economical and safer in terms of risks of disease transmission, but recycling can also happen on a larger scale. There are various ways in which nutrients can be recycled: be it large scale short rotation plantations for willow that produces wood pellets as a sustainable energy source (an EU-funded project in Eastern Europe), a pilot project in reusing source separate urine from apartment buildings in Sweden to grow barley (JOHANSSON 2000: 22-27), a banana plantation on the outskirts of Bangalore fertilized with urine from a communal slum toilet (HEEB & GNANAKAN 2003: 155) or the household based reuse of composted human excreta in Zimbabwe (MORGAN 2007: 76-87). Sanitised greywater can be used for irrigation (agriculture, parks etc.), but may too be used for groundwater recharge or discharged into surrounding watercourses if there is no direct use for it.

### **3.2.3 Advantages of Ecosan**

Due to their closed-loop and modular, decentralised approach, ecosan systems have several advantages over conventional approaches, and can help to overcome the drawbacks of conventional sanitation.

#### ***Prevention of Pollution***

Ecosan collects and contains excreta, and sanitises them before they are recycled into the environment. This approach prevents not only the spreading and transmission of diseases, but also protects waterbodies from being polluted. Nutrients are recycled to the soils, where they actually come from, and not into waterbodies. This minimises their eutrophication.

Though the risk that micropollutants get into the environment is not eliminated with ecosan systems, source separation and the reuse of nutrients may have important advantages: Due to time and pH changes during the source separate storage of urine, pharmaceutical residues are destroyed up to a certain degree (STROPMEN ET AL. 2003 in HAMMER & OTTERPOHL 2006: 476), and can be eliminated furthermore via photodegradation (BUSER ET

AL. 1998 in HAMMER & OTTERPOHL 2006: 476). Besides, soil ecosystems can deal much better with micropollutants than aquatic ecosystems, because they are biologically more active. They are much more stable and degrade pharmaceutical residues to a certain extent (GROTE ET AL. 2004 in HAMMER & OTTERPOHL 2006: 476 and JÖNSSON ET AL. 2004: 8).

### ***Health Improvements***

One of the fundamental principles of any sanitation system is that it forms a barrier between excreta and people and thus prevents the spread of diseases (JENSSEN ET AL. 2004: 14). This is of course also the core aim of conventional flush systems, but instead of sanitising the excreta themselves, they often just shift the problem spatially. By not introducing human waste into the water cycle, the contamination of superficial and ground waterbodies can be avoided. From a public health point of view, this is an important achievement. As well, if adequate treatment methods are used, the spreading of pathogens on agricultural areas can be prevented. With most ecosan systems, especially with the dry handling of the faeces, the primary treatment is moved to the household installation instead of being part of a centralised system. International research indeed shows that dry ecosan sanitation systems may give an equal or higher reduction of pathogens than conventional systems and a high reduction in the subsequent risk of exposure (STENSTRÖM, 2001: 4).

### ***Promotion of Recycling and Conservation of Resources***

Recycling is an inherent part of ecosan. Nutrients and organic matter that are taken from the soil are reused. This allows for a much more balanced fertilization of the soil than with chemical products. Sanitised urine and faeces contain all of the trace elements that are ingested. Additionally, also organic material that has been removed from the soil in the form of plant fibres is restored. This ameliorates the soil structure and its water holding capacity of the soil (JÖNSSON ET AL. 2004: 24), and is hence of increasing importance in areas with degraded soil, or in drought prone areas. Ecological sanitation where both urine and faeces are recycled enables 70 to 90% of the nitrogen, phosphorus and potassium in excreta and wastewater to be reused for agricultural purposes (VINNERÅS 2002: 66ff.). In addition, ecosan systems decrease the amount of water needed for sanitation in general and can help to restore depleting groundwater reserves. "This is of key importance since water is a major limiting factor for development in many countries" (JENSSEN ET AL. 2004: 7). This approach conserves resources, not only by lowering the water consumption and restoring nutrients to the soil, but also through the fact that less artificial fertilizer has to be produced and applied.

Ecological sanitation systems can furthermore help to produce sustainable energy (biogas production), thus lowering the need for non-renewable energy sources.

### ***Affordable Options for All***

Ecological sanitation, by favouring decentralized concepts, cuts back on the cost of wastewater treatment. In ecosan systems, preference is given to modular, decentralized and partial-flow systems. These systems can also be incorporated into already existing settlements with limited spatial resources. By investing the same amounts of money, municipalities could serve a much larger percentage of the population than if they apply conventional systems. Though it is difficult to give exact costs, figures suggest that annual costs for ecological sanitation systems are lower than for most conventional system (UNEP

2004: 7). If comparing decentralised solutions, ecological sanitation systems may have somewhat higher initial costs than, as an example, conventional pit latrines. Yet, full cost calculations, including external costs such as the pollution of the environment, depletion of nutrients in soils etc., are currently not available. In addition, ecological sanitation systems include lots of external benefits that are difficult to estimate – such as for instance increased soil fertility or improved food security – and many that cannot be measured in monetary ways at all (e.g. improved health, more dignity, and higher quality of life).

If human excreta are no longer regarded as waste products, they are inherently attributed an economic value. Ecological sanitation can consequently create local business opportunities for construction, operation and maintenance of sanitary facilities and sale of fertilizer and fertilized produce (JENSSEN ET AL. 2004: 7), further creating financial incentives.

### ***Contribution to Food Security***

By recycling nutrients, ecosan helps to preserve soil fertility and consequently food security on a large scale. In many small-scale ecosan systems, the fertilizer families get from their ecosan toilets is an important resource for household gardens also in urban areas. Urban agriculture can improve the access to nutritious food. Treated excreta and greywater could help families save money by growing their own fruit and vegetables and/or selling some of the produce. The loss of vitamins and nutrients during long transports and storage times on the market can be minimised.

### ***Dignity and User Comfort***

Many of the conventionally used sanitation system include tasks that bring with them not only a high health risk, but are repugnant and severely impair the dignity of human beings. Such tasks include the manual cleaning of dry toilets (manual scavenging), emptying of pit toilets, or the manual unclogging of sewage pipes. In development countries, the necessary technical equipment to carry out these tasks is often not available, forcing the lower strata of society to perform these extremely unpleasant tasks. In ecosan systems, human dignity is a core criterion; well developed two-vault urine-diversion dehydration toilets for instance are very easy to operate and include only the handling of safe and sanitised excreta.

Through the integration of on-plot sanitation into households, the user comfort and security, especially for women and girls, can be greatly enhanced. In the absence of a toilet, women often have to wait to relieve themselves until it is dark. This practice puts women at a high risk of sexual abuse. Additionally, in order to be able to do this, women often deliberately drink less during daytime hours<sup>11</sup>. As a consequence, women suffer frequently from constipation or urinary tract infections. By building low cost, decentralised toilets even in densely populated areas such as slums, where conventional sewerage is often not possible, these unsafe and inhumane conditions could be acted against.

### ***Accepting Cultural Preferences***

Ecological sanitation systems focus on respecting cultural preferences as much as possible. They inherently have to consider the end user much more than centralised systems, as they

---

<sup>11</sup> In a survey conducted by the author herself in March 2006 in Vimochana Nagar, an illegal squatter settlement at the outskirts of Bangalore, many women stated that they do drink less in order not to have to expose themselves to the view of men when urinating during the day (CONRADIN 2006: 12)



rely on semi-centralised or decentralised options with a higher involvement of the users of the sanitation system.

Hence, ecological sanitation is a holistic and interdisciplinary approach that includes hygiene, water supply and sanitation, resource conservation, environmental protection, town planning, agriculture, irrigation, food security, human dignity and the promotion of small scale enterprises. In conclusion, one of the most important advantages and core points of ecological sanitation is that it promotes a material flow-cycle instead of a linear one. The value of excreta – as a fertilizer and energy source – is recognized and incorporated in every ecosan system.

### **3.2.4 Challenges for Ecosan**

As ecological sanitation is still a relatively new approach, it faces challenges and has to overcome important obstacles in order to become more widely accepted and actually implemented on a larger scale. Some of the difficulties include technical aspects such as design, large-scale manufacturing, cost, or maintenance; but the most important and most challenging impediments are probably those on the institutional level. The following chapter gives a brief outline of what the author perceives to be the most pressing challenges concerning ecological sanitation.

#### ***Institutional Aspects***

Many countries currently lack regulations that deal with sanitation options other than conventional centralised sewage. At the beginning of 2007, the WHO published its new four volumes “Guidelines on the Safe Use of Wastewater, Excreta and Greywater” (WHO 2006), of which the first volume includes policy aspects and regulations. Still, though this publication may serve as a regulatory guideline, it cannot replace national laws. Often, contradictory or inconsistent laws and regulations concerning reuse actually impede the development and implementation of new ecosan systems.

Besides, conventional sanitation and ecological sanitation are often not measured by the same yardstick: While no or very lax regulations are applied to conventional sewerage, and while the direct discharge of untreated sewage, its infiltration into the groundwater, or the eutrophication of waterbodies with its adverse effects are often not considered to be a problem at all, stringent regulations apply to new approaches.

#### ***Mindsets***

A challenge inherently connected to the institutional aspects is the one of changing mindsets. Not only is it a fact that governing bodies often lack the knowledge about the negative side-effects of conventional water-based sanitation, but they are generally ill-informed about possible alternatives. Likewise, sanitation and water supply are frequently located in the same departments; and the latter is much more often given priority over the former. In order to overcome the abovementioned institutional challenges, specific training and information of decision making bodies is urgently necessary. Though the success of a certain sanitation approach essentially depends on the end users, authorities and governing bodies often have more means at hand to induce changes in the ways sanitation is being dealt with.

Changing mindsets about sanitation is difficult at any level of society, and motives for a change in sanitation system may differ widely. Essentially – and this is true both for developed and developing countries – ecological sanitation systems will only be accepted on a wider scale if the system does not bring about any loss in comfort (which can also include more maintenance work), or alternatively, if the surplus in maintenance is not made up with other advantages. The direct reuse of fertilizer on site (e.g. in family gardens) is a favourable solution in some places, but the acceptance of ecosan will inevitably be greater if the operation and maintenance tasks are outsourced to a professional service provider. Specialized companies should take care not only of the direct operation and maintenance tasks of the sanitation system, (e.g. emptying the urine collection containers), but too of the subsequent hygienisation and reuse. This would ensure the professional handling and treatment of human excreta and could lead to standardised end products with high and consistent quality.

### ***Need for Education***

In order to tackle the above challenges, there is an urgent need for more education at all levels of decision making. This does not only include official institutional bodies such as national and local authorities, planning agencies and decision makers, but also community based groups, NGOs, and persons who have an influence on decision making and the formation of opinions in individual households (this could also include students and school children). It is a matter of course that the education material be culturally adapted and tailored to the local needs. Only if there is a more thorough understanding of the problems caused by current sanitation practices *and* the existing alternatives at all levels of society can the fundamental shift in the sanitation paradigm needed to make ecosan *the* sanitation option of choice take place.

## **3.3 Mongolia and Ecosan**

Considering the specific framework conditions in relation to sanitation in Mongolia as mentioned in chapter 2, and the inherent drawbacks of conventional sanitation, it becomes clear that conventional centralised sanitation is not the most suitable option to increase the access to sanitation in Mongolia. The ecosan approach could help in finding adequate sanitation solutions in Mongolia for various reasons.

### **3.3.1 Rationale for the Implementation of Ecosan in Mongolia**

The framework conditions described in chapter 2 have profound implications on how adequate – not only in a hygienic sense, but also in an environmental one – sanitation options should be designed.

#### ***Climate and Limited Water Availability***

The extreme continental climate of Mongolia – in many parts, the average annual temperature lies below zero – and permafrost impede the construction of underground structures such as sewer or water pipes. Besides, severe cold further inhibits the functioning of conventional wastewater treatment plants, as bacterial activity is slowed down. As smaller rivers freeze thoroughly, the discharge of treated wastewater is an additional difficulty.

The availability of water is limited in most parts of Mongolia. In consequence, the use of water for sanitation should be kept to a minimum. Furthermore, sanitation options that work without long pipes and also function during the cold winters are needed. Wastewater should be reclaimed for further usage whenever possible. As groundwater accounts for 80% of the water used in Mongolia (WORLD BANK 2004: 16), groundwater recharge gets more and more important. Water should not be pumped from the ground and then discharged via surface waters, especially when considering, that through very high evapotranspiration and runoff rates, only approximately 3% of the annual precipitation infiltrates the soil to replenish aquifers (BATJARGAL 1997: 108). Fully fledged ecosan projects that propose both the recycling of wastewater and greywater could therefore be an important contribution to safeguarding natural water resources and promoting a wiser water use.

### ***Population Patterns***

A very sparsely scattered population makes centralised systems often impossible, just as the nomadic lifestyle of a large part of the population does. On the other hand, Mongolia faces the effects of a rapid and uncontrolled urban growth. The provision of an adequate infrastructure at such a speed and in informal settlements is always very demanding. However, solutions are urgently needed, as the current practice has already resulted in severe groundwater pollution in urban areas (MARTI 2007: 5). Local government officials usually consider ger areas to be the single largest source of environmental degradation in their towns (DORE & NAGPAL 2006: 8), a fact that is not last attributable to lacking sanitation options. Centralised sewer based systems are not recommendable due to climatic and environmental reasons, and are usually much too expensive. In the case of Ulaanbaatar for instance, “the City of Ulaanbaatar can neither finance these investments [sanitation improvement in ger areas] out of its own revenues, nor borrow for them from commercial sources at this time, as its financial position is extremely weak” (CIDP 2006: 9). Inexpensive and decentralised solutions for the improvement of the sanitary situation as proposed within the framework of ecosan are therefore needed urgently, especially as cities continue to grow.

### ***Tourism***

Another aspect that has to be considered when talking about the provision of sanitation in Mongolia is the vast number of tourist infrastructures, which are usually located far away from cities or towns and generally lack sustainable sanitation concepts. Though claiming to offer eco-tourism, the term “eco” is usually used in its broadest sense as vaguely related to nature, or as visiting nature. Tourism is becoming more and more important also from an economic perspective; it is the third major economic sector for Mongolia (BLUNDEN 2004: 48). As unspoiled nature and the environment are the prime attractions that Mongolia has to offer, it would be more than necessary to actually implement concepts for ecological tourism in a stricter way. This would also include sustainable and adequate sanitation concepts. Unsanitary tourist infrastructure is becoming ever more problematic; be it, because tourist camps use high amounts of precious water resources such as facilities in the dry steppes or the Gobi Desert, or also because they cause problems in relation to pollution. Usually, a significant number of people concentrate in one spot during a relatively limited period of time. The generated wastewater is hardly ever treated and can lead to environmental pollution. In this case too, decentralised solutions that do not contaminate the environment are needed.

Besides, tourist lodges also have a responsibility to respect the polluter-pays principle, i.e., they have to recognize that those who establish a business in a certain area should take care not to pollute the environment and the livelihood basis of the local population – a principle inherent within the concept of ecosan. –

### ***Soils, Soil Degradation and Desertification***

Due to the climatic factors mentioned above, the natural ecosystems in Mongolia, including the soils, are generally very fragile and highly susceptible to degradation. The rates of humus production are very low, the organic matter content of the soils is on average just 3 to 4%, and the vegetative regeneration very slow (BATJARGAL 1997: 109). Many soils have lost their natural fertility due to degradation.

According to a 1998 report, the largest part of Mongolia's lands shows some extent of degradation: only 1.7% is not degraded (MARRIOT 2005b: 79). About 90% of Mongolian territory can be regarded as vulnerable to desertification (BATJARGAL 1997: 107).

The reasons for this intense land degradation are manifold: The most prevalent cause is overgrazing, especially around settlements, where traditional nomadic practices are not followed any more. In addition, widespread deforestation has led to soil degradation and changes in the water household (BATJARGAL 1997: 110ff.). During the last century, Mongolia has lost almost one fifth of its forests due to logging or forest fires (WORLD BANK 2002: 8). Other reasons for soil degradation include agricultural mismanagement, e.g. land tillage in spring when strong winds are prevalent, vehicle-induced degradation from overland travel in the absence of an established road network, or the topsoil removal by mining.

The systematic recycling of both nutrients and organic compounds contained in human excreta could be one strategy to counteract these negative trends, at least in agricultural areas by improving the soil structure through the addition of ecosan fertilizer. Of course, it could be argued that the same effect is achieved by animal dung. However, as wood is generally a scarce resource in Mongolia, animal dung is often not left on the grazing areas, but collected as a fuel for stoves. Human excreta are not used nowadays. They would therefore constitute an option to enhance the soil quality and structure by the addition of organic material. The organic material also increases the water holding capacity of the soil, which is crucial considering the dry climate of Mongolia.

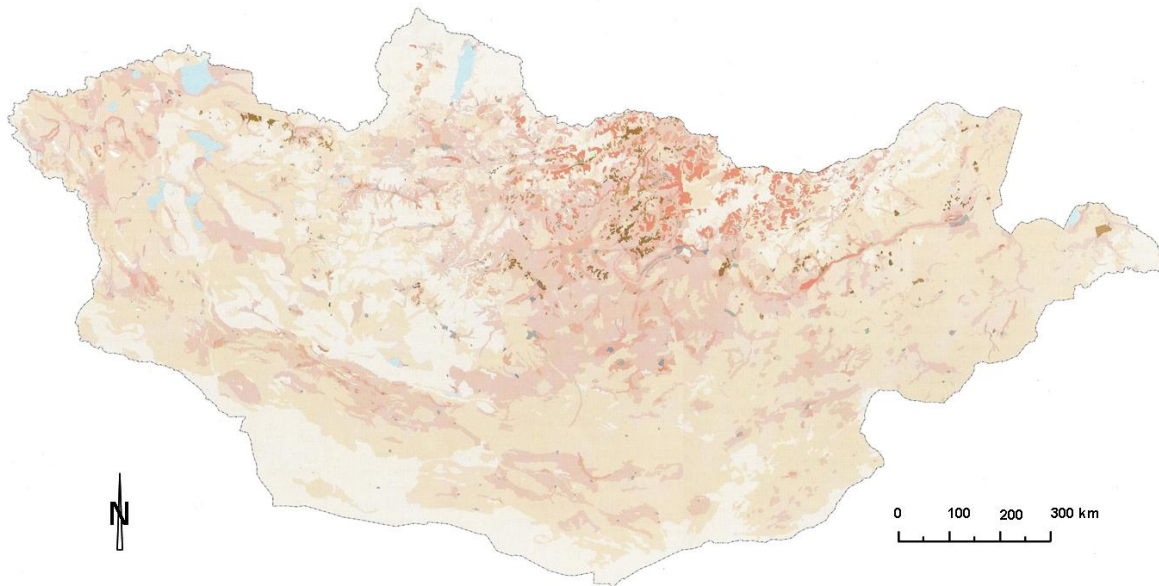

Degradation extent	State of natural ecosan systems
Slightly degraded or degradation is absent	Good state on the whole, the soil-plant cover is locally degraded; Revegetation is possible
Slight to moderate degradation	Satisfactory state; ecosystems are adversely affected by rate of stocking (water sources, springs, wells, yurt stands); as a rule, natural rehabilitation of the major degraded areas is possible.
Slight to moderate degradation	Satisfactory state; the number of degraded areas is higher than that mentioned above. Natural recovery is hardly possible; phytomelioration and restricted use of natural resources are required
High degradation	Bad state; the soil-plant cover revealed irreversible destroying in some places; natural revegetation is practically impossible; phytomelioration, restricted land use are required
Very high degradation	Very bad state; natural ecosystems have been transformed into artificially created ones or even into badlands (dumps, waste heaps, quarries, etc.); natural rehabilitation is impossible; amelioration and rehabilitation measures are required.
Anthropogenic settlements and ecosystems	
Fields and fallows	

Source: VOSTOKOVA & GUNIN 2005: 32

**Map 1: Land degradation in Mongolia and types of pressure**

Map 1 shows that large parts of the land in Mongolia are degraded. Even in the lightly coloured areas, there may be some degradation. The most important causes are overgrazing, forest cutting, forest fires, land tillage, roads and urbanisation (VOSTOKOVA & GUNIN 2005: 32).

Indirectly, ecosan solutions could counteract soil degradation through deforestation by providing alternative bio-fuels. Nutrients contained in excreta could e.g. be used to specifically grow firewood or provide other renewable energy sources, so that the natural forests need not to be cut down.

The various approaches within the framework of ecological sanitation could on the one hand pose a solution to the pressing problems with the provision of sanitation. On the other hand, they could also aid in mitigating the effects of environmental pollution through a lack of wastewater treatment, could help in restoring groundwater reserves, and could even counteract soil degradation and desertification when applied on a large scale (see also 9.1.1).

### **3.3.2 Limitations for the Implementation of Ecosan in Mongolia**

Though the implementation of sanitation solutions based on the ecosan approach could bring many advantages, there are also some important limitations which have to be carefully reflected before deciding on any specific concept. While some of the limitations need serious considerations, others are only seemingly restraining. They are discussed here because they are frequently mentioned prejudices concerning the ecosan approach in Mongolia.

#### ***Overabundance of Animal Dung***

It was an often heard argument that there is no need for reusing neither hygienised urine nor faeces as a fertilizer: there would be enough dung from cattle (horse, sheep, cow, goats, yaks etc.). At a first glance, this seems to be true: the number of livestock is much higher than the number of people. In 2003, there were 2'504'400 inhabitants (NSOM 2003: 32), as opposed to 25'427'700 heads of livestock (including sheep, goat, horse, cattle, and camel) (IBID. 132). However, as mentioned above, animal dung is not always available as a fertilizer. In the treeless steppe, it is often the only fuel source available for cooking and heating. Furthermore, using ecosan fertilizer would have one big advantage in comparison to the naturally available fertilizer, namely, that ecosan fertilizer is collected centrally. Due to the fact that most herders in Mongolia are pastoral nomads, who do not generally know animal stabling, dung is just dropped in the countryside wherever the animals are. If – as is the argument of those contending this theory – animal dung would be used instead of human excreta for fertilizing purposes, it would have to be collected by hand in the absence of stables. Furthermore, it would be naturally only possible to reuse the faeces of animals, as there is no means of collecting the urine.

Besides, Mongolia imports artificial fertilizer too: though the rates have sunken drastically since the downfall of communism, several thousand tons are still imported (FAO 2004: 1, Internet). The use of artificial fertilizer further exemplifies that not all fertilizer needs are covered by animal dung.

#### ***Limited Area for Arable Farming***

Due to climatic reasons, only a very limited area of Mongolia is arable; figures range between 5.7% (WORLD BANK 2002: 38) and 1% (BATJARGAL 1997: 110). According to the 2003 census, only a little more than 7'000 km<sup>2</sup> were used as arable land in 2003. This is less than 0.5% of the total surface area of Mongolia. However, this figure used to be almost double during communist times (WORDEN & SAVADA 1991: 131). The agricultural sector is now again subject to great change, as the Mongolian government is encouraging the development of the agricultural sector and supporting small-scale farming. In 1997, the “Green Revolution” programme with the goal of increasing crop production, has been launched. Moreover, according to Mr. Enkhtuvshin, head of the foreign affairs division of the Mongolian Organic Farmer's Association, Mongolia's investments in the agricultural sector are also strategic, as Mongolia is almost entirely dependent on Russia and China for food imports. If there are tensions with either of the two countries, there will very soon be critical food shortages (ENKHTUVSHIN 2007). For this reason, small scale farming is currently encouraged.

Nevertheless, parts of the land that was previously identified as arable land is actually not suitable for crop farming (MARRIOT 2005b: 88); its use for farming would essentially lead to

degradation. Any ecosan reuse concept must consider this, and should also consider other reuse options besides agriculture. But even if arable farming might not be the primary acceptor of potential ecosan fertilizer, there are still various other approaches for reuse, e.g. reforestation, fruit or berry orchards.

### ***Limited Water Availability***

As Mongolia is a very dry country, any reuse concept should as well consider the water use of the proposed plants. The dry climate may make it necessary to irrigate the crops used for the reuse of the fertilizer. This decision always has to be considered very carefully. Neither should – just for the benefits of reuse – other water usages be compromised, nor should existing water sources be depleted. In any case, ecosan projects should recycle and reuse as much of the generated waste- or greywater as possible; this might be the only way in which plants can be irrigated.

### ***Natural Vegetation and Short Vegetation Period***

A sensible and adapted reuse of ecosan fertilizer may be more difficult in Mongolia than in other countries. Not only is the percentage of arable land limited, but many of the naturally occurring plants have adapted to the limited availability of nutrients and do not need much fertilizer. Therefore, large areas may be necessary for reuse concepts, as each plant only has a limited nutrient uptake. Also the short vegetation period, and therefore the short period where nutrients are taken up, may be a limiting factor. Most ecosan projects would therefore have to include large storage volumes for the generated fertilizer, or would have to develop innovative approaches of what to do with the fertilizer in winter (e.g. the application of frozen urine-fertilizer that thaws in spring).

### ***Transport of Excreta***

In addition, the logistics of ecosan projects must be considered. As the arable land is limited to some provinces in central Mongolia, fertilizer cannot be used everywhere for farming. The same applies if the fertilizer would be used for reforestation or mining recreation (see 9.1.6). As Mongolia is a very vast country, where the only means of transport is basically by roads, the sustainability of potential fertilizer transport must be carefully calculated.

### ***Acceptance***

In a country that has lived from nomadic animal husbandry for the last thousand years, and where arable farming always had a limited importance, the introduction of the ecosan based loop approach is undoubtedly more difficult than elsewhere. Traditionally, Mongolians disdained the raising of crops; this was conducted mainly by Chinese farmers. Though efforts have been made to turn Mongolia into an agrarian society during the communist rule, the results of this 70-year-long struggle soon vanished again after 1990. Mongolians are not totally averse to any kind of crop production, but reuse based ecosan concepts will have to be chosen sensibly and will most likely need much more awareness raising and mentoring than in agrarian societies.

### 3.4 Existing Ecosan Projects in Mongolia

So far, very few ecosan projects have been implemented in Mongolia, and the approach is not yet widely known. To date, there are only two projects within Mongolia; one of them has terminated in 2004.

#### 3.4.1 Norwegian Lutheran Mission Ecosan Toilet Programme

The ecosan toilet programme by the Norwegian Lutheran Mission (NLM) was carried out from 2002 until 2004 within the activity of the Health Development Project in two Mongolian provinces, Selenge and Darkhan-Uul aimag<sup>12</sup> in northern Mongolia. The main goal of the project was to alleviate health and sanitation problems commonly associated with pit latrines (NLM 2004: 4). During this time, 30 ecosan toilets were built. They consisted of an indoor plastic urine-diversion squatting pan on a raised platform, under which the receptive buckets were stored (see Photo 1 and Photo 2). When the buckets were full, they were pushed to the side and replaced by another bucket; like this, only one vault had to be built<sup>13</sup>. After a storage and dehydration period, the faeces would be safe for reuse in private gardens (IBID: 4ff).



Source: NORWEGIAN LUTHERAN MISSION

**Photo 1: The NLM toilet with a squatting pan**

The NLM toilet consists of a raised platform with a squatting pan. The faeces hole is covered by a moveable slab.



Source: NORWEGIAN LUTHERAN MISSION

**Photo 2: Storage chamber below the NLM toilet**

Below the toilet slab, there is a storage chamber with moveable buckets. Like this, fresh faeces can be stored apart from older ones without a second vault.

A project evaluation was carried out after two years. Though the idea as such is considered sensible, there were certain problems. Most people were much more interested in comfort and convenience than preventing diseases and pollution (IBID.: 4). The marketing strategies of how to advertise ecosan must therefore be carefully designed.

A big problem was that the excreta had to be handled indoors, and full buckets had to be carried through the house, which was perceived as unpleasant. It also seems doubtful whether the small buckets allow for a sufficient hygienisation of the faeces; if not, the health risks involved with handling rather fresh faeces are unnecessarily high, and the concept as such is in some ways reminiscent of a bucket latrine. Most people did not like the squatting platform and would rather have opted for a sit-down toilet. It must however be noted, that at

<sup>12</sup> Aimags are the political and administrative unit equivalent to provinces in Mongolia.

<sup>13</sup> Normally, a UDD Toilet is built with two vaults. If one vault is full, it is locked and left untouched until the faeces are hygienised. Either, there has to be a moveable toilet seat, or two cubicles have to be constructed which are used alternately.



The main recommendations from the evaluation report are as follows: The design of the toilet should be improved. The report states that “until there is a design with a higher rate of satisfaction, people are unlikely to build these toilets from their own initiative” (NLM 2004: 6). It should maximise comfort while not sacrificing the main principles of ecosan: preventing pollution, providing hygienic sanitation solutions and recycling nutrients. Though the idea and the concept as such are good, much more awareness raising and support would be necessary to make sure that ecosan is accepted and implemented properly.

### **3.4.2 GTZ Ecosan Pilot Projects in Ulaanbaatar**

The German Agency for Technical Cooperation GTZ started its ecosan activities in Mongolia in 2006. Five pilot project toilets (urine-diversion dehydration toilets) were set up in different ger areas in Ulaanbaatar from October 2006 until March 2007. A prototype of the used toilet is available now for further implementation (see Photo 3).

The aim of this pilot phase was to adapt the toilets, which have so far mainly been used in warmer climates, to the extreme cold. The ecosan project is part of a larger project for integrated urban development.

The toilet model itself consists of a two vault urine-diversion dehydration toilet and a urinal; both are produced out of fibreglass in Ulaanbaatar (Photo 4). The prototype consists of a modular toilet, where the toilet seat and the urinal can easily be moved as to facilitate the alternative use of the two vaults. If one vault for faeces is full, the toilet can be moved to the other side, and the other vault is used. The first one is left untouched until the faeces are hygienised. Urine is lead to a central container which is emptied when full. Both vaults have a drawer-like design that makes the removal of urine containers or dried faeces very easy (Photo 5). In order to prevent the formation of “stalagmites” from frozen faeces, the initial toilet was improved with a mesh where the faeces fall upon. This guarantees a better aeration and drying of the excreta, and a more even distribution even in winter.

Urine is sanitised through storage, and the faeces are dried. It is assumed that the intense cold will support the die-off of pathogens contained in the faeces. Both urine and faeces will be reused for the local production of vegetables.

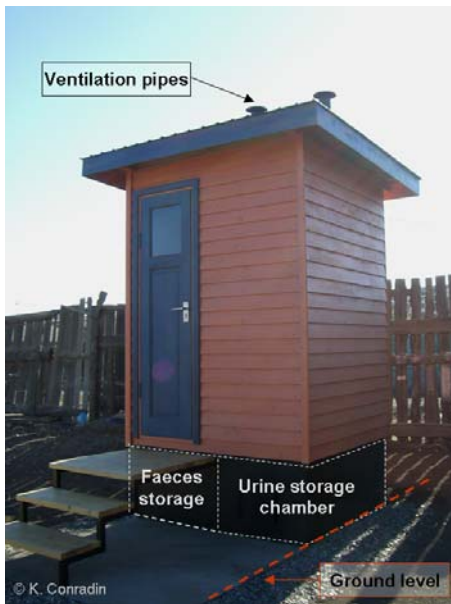

Source/Photo: K. CONRADIN

**Photo 3: Outside view of the GTZ ecosan toilet in Ulaanbaatar**



Source/Photo: K. CONRADIN

**Photo 4: View of the GTZ toilet from inside**

The above photos show the GTZ toilet from outside and inside. The whole toilet is built above ground. A cement slab prevents infiltration of leachate into the ground. The ventilation pipes and the collection chamber are both painted in black to absorb as much solar energy as possible. The toilet seat and the urinal visible in Photo 5 can be moved if the faecal collection chamber below the toilet is full.

The results so far are promising to what concerns the acceptance. No systematic interviews on the acceptance of the toilet were done on behalf of the author. At least the beneficiary of the visited pilot project toilet, Mrs. Chuluuntsetseg, a social activist and gardener, was very happy about her new toilet, and was very much willing to reuse the fertilizer generated by the toilets (CHULUUNTSETSEG 2007).

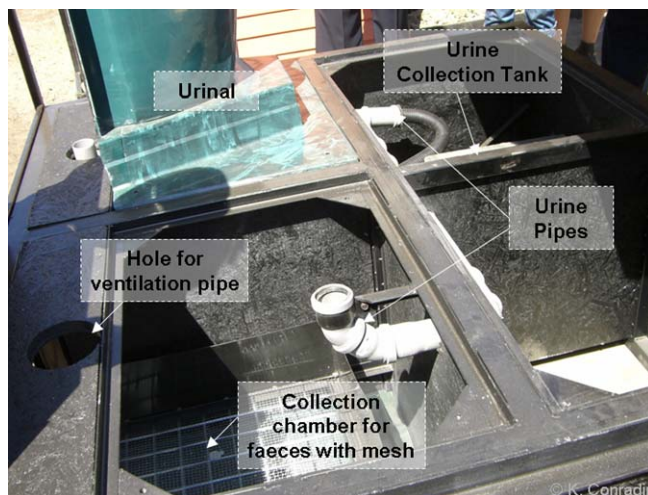

Source/Photo: K. CONRADIN

**Photo 5: Assembling of the GTZ toilet**

Through the modular build-up of the toilet, it can be erected within a few hours. The urinal and the toilet seat can easily be exchanged if one collection vault for the faeces is full.

It cannot be confirmed whether this attitude is shared by other users, but according to Mrs. Erlbeck, director of the integrated urban development and construction sector programme of the GTZ, there was indeed a great demand for good fertilizer and compost (ERLBECK 2007). The target groups for the toilets are very openly defined, including schools, elder citizen's homes, hospitals, tourist infrastructure, in fact, all those not connected to central sewerage. However, due to the high price of this toilet model, which at the moment lies at about 900'000 MNT (ca. 530€), it will be unaffordable for the

largest share of the poor ger area residents without subsidisation. Furthermore, greywater concepts have not yet been established; options are being investigated this year.

## **4 PROCEDURE AND METHODOLOGY**

This being a study carried out in a remote and rather unfamiliar, it seemed most adequate to use a multitude of methods to get a balanced picture for analysis. This study applies methods that are not only used by geographers, but also by anthropologists, sociologists, or ethnologists. Yet, the focus of the study – the provision of adequate sanitary infrastructure and its adaptation to specific spatial environments – is geographical in its core. This study stands on three pillars, based on three important groups affected by decisions on sanitation within the Lake Khuvsgul area: lodge owners, tourists and local people. In the analysis of lodge owners' perception, the research focus lied both on the assessment of current practices, their current evaluation of the environmental situation, their acceptance of new systems and their willingness to implement alternative sanitation technologies. The second group (tourists) are essentially the clients, and have a large influence on lodge's decisions with their support or rejection of certain management procedures and concepts regarding the environment. The third group are the local people; they are the ones who experience the consequences of any kind of decision most directly. Additional important data was gathered by constructing a trial garden, which served both to research the effects of urine fertilizer in this specific area and to demonstrate this to local people and tourists.

Lodge owners were interviewed in qualitative, semi-structured in-depth interviews, which form the core of the lodge owners study. This data was supported by a quantitative survey on the current sanitation situation of almost all the lodges in the Khatgal area. Tourists were interviewed with a standardised quantitative questionnaire. Additional data was collected in countless informal communications and discussion with dozens of tourists. The data on the local population stems both from two day-long, interactive community meetings, from informal talks to the locals, and from observation. The research as a whole was complemented with various expert interviews.

### **4.1 Procedure**

The idea for this whole study sprang from a visit to Lake Khuvsgul area in autumn 2006. During this journey, it became clear to the author that this unique and pristine, but not yet overly developed area would be an excellent opportunity to implement ecological sanitation concepts. If applied soon, it would be possible to prevent problems and pollution resulting from lacking sanitation instead of dealing with it in hindsight. By a great coincidence, the author met Kent Madin, a lodge operator in Khatgal who was actually planning to install a pilot urine-diversion dehydration toilet within the compound of his lodge. Accordingly, after innumerable emails and phone calls, a research design was developed in cooperation with Jacqueline von Arx, MSc Candidate in Geosciences, and at a later stage, Oyunmunkh Byambaa, a MSc Candidate in Biology from the National University of Mongolia.

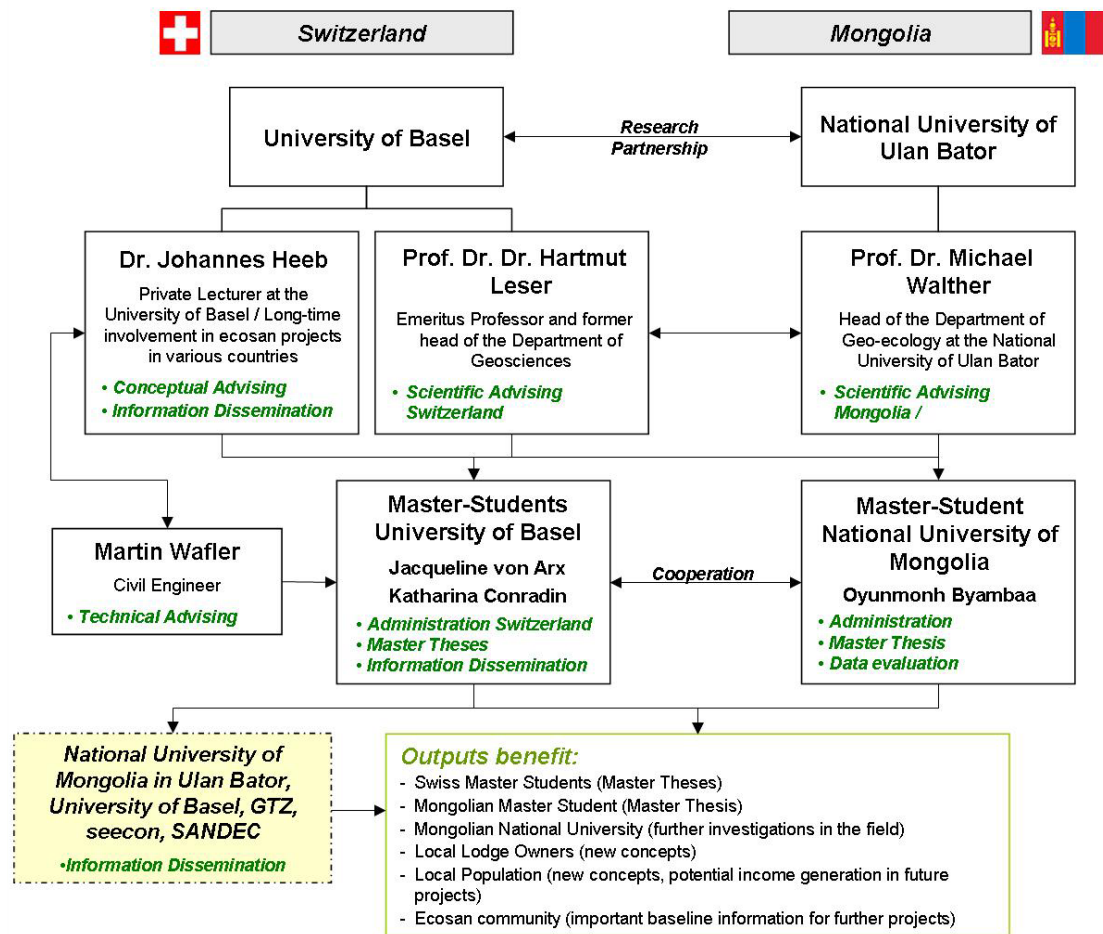

Source: K. CONRADIN & J. VON ARX

**Fig. 6: Structure of the research partnership**

The research partnership involved partners from Switzerland, Austria and Mongolia and made a smooth and efficient project procedure.

Academic support in the planning and designing of the study was given by Prof. Dr. Hartmut Leser from the Department of Geography, University of Basel, Prof. Dr. Michael Walther from the Mongolian Landscape Research Centre, National University of Mongolia in Ulaanbaatar, and Dr. Johannes Heeb. Specific counselling on technical issues of ecosan was given by Martin Wafler. In order to work on the research issues in an efficient and professional manner, a research partnership between the two abovementioned institutions was formed. With regard to financial support for this study, a project proposal was submitted to the Commission for Research Partnerships with Development Countries KFPE<sup>14</sup>, who granted the three researchers with a total of 9'820 CHF in April 2007.

The fieldwork in Khatgal took place from June to September 2007, in order to allow for sufficient time in the field and to cover the largest part of the vegetation period (trial garden). During the fieldwork, the team was supported by practical advice and mentoring from Prof. Dr. M. Walther. Data analysis for this thesis was performed from August until November 2007.

<sup>14</sup> The KFPE is a project of the Swiss academies, "dedicated to promoting research partnerships with developing and transition countries. In this way, it wishes to contribute to sustainable development." The organisation receives financial support from various Swiss educational and charitable organisation

## 4.2 Theoretical Framework

In order to get comprehensive and well balanced results from this study, an array of different methods was used. This process of drawing on different sources and methods is called triangulation (FLICK 2006: 331 and VALENTINE 2001: 45), and does not only serve to validate study results, but enriches and completes the insights gained (FLICK 2006: 331). In this study, there was a triangulation of methods (both qualitative and quantitative), but also a triangulation of data, i.e., data from different sources was analysed and compared.

### 4.2.1 Qualitative Research

#### ***Characteristics and Advantages of Qualitative Research***

Qualitative research focuses on so called “soft facts”; it is used to elucidate human environments, individual experiences, or social processes. Qualitative methods are used

[...] in different conceptual frameworks to reveal that which has previously been considered unknowable – feelings, emotions, attitudes, perception and cognition. Overwhelmingly, qualitative methods have been used to verify, analyse, interpret and understand human behaviour of all types (WINCHESTER 2005: 15).

Rather than focusing on an extensive numerical approach, it favours an in-depth, intensive approach, and seeks “subjective understanding of social reality instead of statistical description or generisable predictions” (Dwyer & Limb 2001: 6). In contrast to methodologies that test pre-existing theories, qualitative research is used to actually develop “grounded theory” by systematically and inductively analysing the collected data (IBID.: 6).

#### ***Limitations, Reliability and Validity***

All the same, qualitative research needs to be reflected critically. A point that is often raised is that the results of qualitative research are made understandable to the reader by offering only selective and illustrative quotes or anecdotes (Flick 2006: 318). But qualitative research is more than just quoting: In order to produce reliable and valid data, it is necessary to clearly document their collection and accomplishing, and use a well structured and traceable approach for the data analysis. Producing valid research results does not only start with writing, but much rather comprises “sensible acting” (FLICK 2006: 328) throughout the whole research process.

### 4.2.2 Quantitative Research

In contrast to qualitative research, quantitative research is positivist and uses deductive methods. Data is generated by using standardised approaches on a range of variables and then trying to identify patterns of causal relationship between these variables (Henn, Weinstein & Foard 2006: 117). The most commonly used technique is the sample survey, using standardised questionnaires.

While quantitative are well suited to analyse measurable phenomena, they are less adapted to generate a valid assertion on attitudes, emotions or causalities dependent on human behaviour. Though often termed more “scientific”, even statistical data is subject to the researcher’s interpretation. A well structured research approach is crucial: this starts with designing a non-influencing questionnaire and ends with the researchers’ ability to see proper causalities and disqualify implausible ones.

### 4.2.3 Considerations for Qualitative and Quantitative Research

#### ***Ethical Considerations***

Conducting both quantitative and qualitative research involves interactions with research subjects. However, the relationships created in qualitative research are usually more personal. The researcher must allow participants to refuse participation or certain answers, should not ineptly invade their private space, and must sensibly interpret and/or use the collected data. The purpose of the study must be made clear to the interviewees, and they must have the option to opt in or out of the study. This criterion is called “informed consent”, and means that the informants know what they are consenting to (SKELTON 2001: 91).

Issues of power are of concern especially in cross-cultural research. Researchers should get away from colonising approaches by employing “postcolonial” research methods

that contribute to ‘others’ self-determination [...] through methodologies and the use of research findings that value their rights, knowledge, perspective, concerns [...] and are based on open and more egalitarian relationships. (HOWITT & STEVENS 2005: 329)

An often employed strategy to overcome these issues is participatory research. Participatory research makes an effort to involve the “others” (i.e. local people) as an integral part of the project. Qualitative research is not only *about* people and their perceptions, but is research that is carried out *with* people. Thus, it is essential to continually reflect what is being done, why the research is being conducted, and what it actually means to and how it influences other people.

#### ***Sampling***

Cases or participants should be selected carefully such as not to bias the research results. Common approaches include typical case sampling, where so called “typical” or “average” cases are selected (such as typical upper-class, middle-class and budget lodges). Convenience sampling involves selecting cases or participants on the basis of access, i.e. tourists who stayed at the Khuvsgul Inn, whereas the selection of “critical” cases targets those participants who can exemplify and clarify the collected data and which are important for its evaluation, e.g. experts (FLICK 2006: 109f.).

#### ***Data Analysis***

Interpreting qualitative data involves the summarising and categorisation of the primary data, i.e., its coding. During this process, recurring terms (codes) are attributed to the empiric material. The purpose of coding is on the one hand the abstraction and reduction in size of the existing data, and on the other hand the structuring of the generated results. It makes the analysis more systematic and allows the researcher “to build up an interpretation through a series of stages, avoiding the temptation of jumping to premature conclusions” (JACKSON 2001: 202). Systematic coding through various levels of abstractions encourages a thorough analysis of the transcripts and helps to increase the validity of the results by making clear that the “researchers have [not] simply selected a few unrepresentative quotes to support their initial prejudices” (IBID.: 202).

### **4.3 Qualitative Methods**

Qualitative methods used in this study were used principally to generate more insight into the cultural acceptability of ecological sanitation, and to draw conclusions on the necessary adaptations of the existing ecosan approach to make it suitable to the respective area. Qualitative methods were chosen because the questions at hand deal largely with attitudes, emotions and beliefs; furthermore, they allowed getting a deeper insight and understanding of the whole situation. Due to the limited knowledge and the lack of previous exposure of the research subjects to ecosan, it was essential not to carry out the research based on pre-existing assumptions, but to allow theories to emerge on site, and to continuously validate the generated results.

The study focussed mainly on environmental issues and did not involve private details about the population. Given that the researcher used a sensible ethical approach as described above and adhered to accepted codes of conduct and a responsible handling of the research results, the study was not overly critical from an ethical point of view. Great care was given to the fact that this was not just a foreign-operated research project, but also involved Mongolian research institutes and other Mongolian students. Capacity in sustainable sanitation is extremely limited in Mongolia; this project involved research, but also contributed to raising these issues in Mongolia, and could give a further impact for capacity building in the field of sustainable sanitation within Mongolia. In this specific case of a tourism area, it can be argued that it is the responsibility of the visiting tourist – i.e., also a foreign researcher – to support actions that mitigate the negative impacts of tourism. As the problems in relation to sanitation were widely recognized, most research participants were actually very happy about the research carried out.

Qualitative methods used in this study included semi-structured interviews with lodge owners and local population, participatory research with the local population, additional expert interviews with non-local experts, and observation.

#### **4.3.1 Semi-Structured Interviews**

Semi-structured interviews or guided interviews are based upon a rough guideline of questions. This allows for a flexible process where the interview is structured along pre-defined thematic issues, but the specific focus of the interview can be adapted according to the situational needs. Semi-structured interviews allow interviewees to express their own ideas and attitudes better than standardised interviews (FLICK 2006: 117). They contain open questions to which the interviewee can respond freely (e.g., what do you think about the ecosan concept? What are the advantages or disadvantages of this system in your view?). Additionally, the interview also contains questions based on theories and hypotheses (such as: Would you favour an individual management of the ecosan toilet or a professional, centralised service?). Here, the interviewee receives a selection of answers which he can accept or refuse (IBID. 2006: 128f.). Limitations exist inasmuch as the interpretation of data generated through semi-structured interviews can prove difficult due to the specificity and the individuality of the answers. This is however not the case here as the answers given by the individual respondents proved to be quite similar and relational.

### **Data Collection**

Semi-structured interviews were carried out in July 2007 with the owners or managers of 18 of totally 43 lodges operating in the Khatgal area (of which four were not in use). These lodges were selected according to their geographical location (several samples from each area, see Map 5, p.55) and their classification (i.e. upmarket, middle, or budget). Lodges were visited personally by the author and her co-researcher and translator B. Oyunmunkh. The managers or owners were explained the purpose of the study and asked if they would be willing to participate in this research. Then, a date for the interview was set, but mostly the participants agreed to conduct the interview on spot. In addition to the interviews, quantitative data on the lodges (such as their date of establishment, the number of guests per season, and their current wastewater management practices) was collected.

In order to explain the ecosan concept, the researchers additionally used pictures and cross-sections of the toilet, if the interviewees had not previously seen the ecosan pilot project toilet. Most of the interviews were conducted in Mongolian, and the questions and answers were translated on site, but some were directly carried out in English. The interviews were taped and later transcribed and complemented with notes taken during the interview session. The interviews usually lasted about one to two hours.

The interviewing was continued until “theoretical saturation” was reached. This means that no more information or insight that further elucidates the research question significantly could be found (GLASER & STRAUSS 1967/1998 quoted in FLICK 2006: 104).

### **Data Analysis**

In the analysis of the semi-structured interview, open coding was used. The data was first segmented into meaningful units, which could be a simple sequence of words, a sentence or a short paragraph. Keywords used by the informants were highlighted and noted at the margin.<sup>15</sup> Like this, a deeper understanding of the text was generated. These initial codes were further abstracted in a second stage and categorised within each interview. A third step involved the comparison and cross-checking of the individual interviews and the construction of so-called meta-codes (JACKSON 2001: 203). This coding process over various stages allows for a detailed and rigorous analysis of the text that enables a thorough and valid dissection of the core message of the text and assures that its interpretation stands on solid ground.



Photo: K. CONRADIN

#### **Photo 6: Interview with a lodge owner**

Interviews with lodge owners were carried out in their own lodges or homes. If the interviewees had not previously seen the ecosan toilet, pictures and cross sections of the pilot project toilet were shown to deepen the interviewees understanding of the concept.

<sup>15</sup> Words or expressions used by the informants themselves that are used as codes are called ‘in vivo’ codes. However, the use of this word is dubious here, as it was often worked with translations of the original utterances (COPE 2005: 224).



### 4.3.2 Participatory Research: Community Meetings



Source: K. CONRADIN

**Photo 7: Guided tour to the toilet**

Participants of the community meetings were all shown the toilet and the trial garden on a guided tour. The mode of operation was explained to them in depth.

Ideally, participatory research approaches involve research *with* people, rather than *on* people. They are about “[...] generating data and working in ways that increases participants’ ability to bring about positive change in their own lives” (KESBY, KINDON & PAIN 2005: 144). The participatory approaches used for this study did not involve such kinds of participation, but rather groups of local people in producing their own maps, diagrams and drawings and analysing and discussing them. Rather than this being action research in itself, the method applied could be the basis for further, intensified participatory research within this area. All the same, the meetings and field visits to the local ecosan toilets

enabled local people to get knowledge which they did not have previously and also started a lively discussion in the village how such approaches could be implemented and adapted to the local setting, and how reuse aspects could be incorporated in such a way as to benefit the local community. At least one family has already started to implement an ecosan toilet on their own and has been very keen in demonstrating it to others. Thus, the research carried out did not only produce results for the researcher itself. Participatory research has the advantage that a wide ranges of issues can be covered relatively quickly; drawing diagrams has furthermore the advantage that complex connections and influences can be expressed more readily than with conventional approaches (IBID. 2005: 151), and makes cross-cultural research more mutually understandable.



Photo: K. CONRADIN

**Photo 8: Participants of the first community meeting drawing a map**

The participation on the community meetings was very good. Both men and women were involved actively in the discussions. During the meetings, important aspects on environmental problems, tourism, ecological sanitation and reuse options, but also strategic issues like local people’s (lack of) participation in decision making processes were raised.

#### **Data Collection**

Two community meetings with a total of 33 participants were held on the 16<sup>th</sup> and the 17<sup>th</sup> of July 2007 (participants are listed in Appendix 4). The meetings each lasted one full day and included a guided tour to the pilot project toilet and the trial garden. The people were informed about the meeting by word-of-mouth advertisement. In total, 17

men and 16 women of different social statuses and strata took part in the meetings in a local café. During the meetings, people either worked independently on their drawings, or were moderated by Mrs. Oyunmunkh. Another person, Mrs. Otgonnyam, took supplementary notes, while the author of this study itself aided in the moderation, the topical guiding, and in analysing the participation of the locals. The following techniques were used:

- **Community mapping:** Mapping is used as a tool that helps to visualise important information about the community as such. The main purpose is not to produce an accurate map but to get useful information about the locals' perceptions of their town, i.e., Khatgal and its surroundings. Here, a specific focus lay on information about the environment and environmental problems present in the village. The participants developed the content and the symbols of the map on their own, according to what was important to them.
- **Influence / rich picture diagram:** Influence and rich picture diagrams are participatory research techniques that use visual representations (simple drawings, symbols, arrows, lines etc.) to identify interrelationships and influences between important elements of a particular issue (HAWKINS, MARMER & MOIR 2006). The participants of the community meetings were asked to draw (or to give inputs for drawing) symbols or pictures that represent particular elements of a certain topic and then to connect these elements with arrows that indicate cause/effect relationships and interdependencies, both positive and negative. Participants discussed these relationships as a group and identified resulting feedback loops between the elements themselves. This tool was used to analyse the human impact on the environment in the Khatgal area (including respective actors), tourism, the ecosan concept and different reuse options. Influence and rich picture diagrams proved to be especially helpful when discussing complex issues and topics that are perceived to have a number of impacts and influences.
- **Problem tree:** To identify and discuss problems related to wastewater management, participants were asked to brainstorm wastewater and sanitation issues within their region. This was done using the shape of a "problem tree" as a guide. A problem tree takes the shape of a tree to analyse different aspects of problems: the problems are listed on the stem of the tree, the roots represent the ultimate causes of the problems, and the crown contains the "fruits", i.e., the potential results and consequences of the problems. Around the tree is room for noting down decisions and possible ways of dealing with these problems.

During the community meetings, observatory notes were taken by the author. Important parts of the discussion were additionally taped and later transcribed. Pictures were taken of all drawings immediately upon their completion, and again after they had been translated and transcribed into English.

### **Data Analysis**

A large part of the analysis of the picture was done during the meeting by the participants themselves, as they discussed influences and potential results and outcomes of the current situation on their own. The pictures offer in themselves a very rich interpretation of the current situation as it is perceived by the local people, including environmental problems,

attitudes towards tourism, problems related to sanitation. Notes supply additional necessary information. Transcripts of the discussion parts can be analysed with the same coding methods as described above.

### **4.3.3 Expert Interviews**

An expert interview is a special form of a qualitative interview where the focus lies not on the person as such but on the function of this person as an expert for a certain field (FLICK 2006: 139). This kind of interview was conducted to collect supplementary information on the field of sanitation within Mongolia and included government officials (hygiene and environmental inspectors), Lake Khuvsgul National Park officials, representatives of various NGOs, the GTZ, professors of agriculture and biology, meteorologists, and medical doctors. The selection of these experts was a continuous process during the research. The interviews were carried out at various stages within the research process. Most of the expert interviews were held in English. The interviews were conducted with a semi-structured guideline of questions specifically prepared for each interview. All interviews were taped and later transcribed.

The analysis of expert interviews was carried out analogous to the procedure described for semi-structured interviews (i.e., coding procedures, chapter 4.2.1). However, in contrast to this procedure, more focus can be laid on individual quotes from the interview, as the expert is regarded as an individual representative for his field of activity.

### **4.3.4 Participant Observation**

The three abovementioned qualitative research methods were complemented with observations and detailed field notes taken every day. Participant observation involves “living and/or working within a certain community in order to understand how they work ‘from the inside’” (COOK 2005: 167). However, it must be noted that this was a supplementary part of this thesis and as such carried out in a rather open manner, whereby the author took a role as an overt observer, not that of an active participant within the community. This task involved noting the observations as field notes in a research diary and complementing these notes with number of photographs. Access to the community was gained mainly through the involvement with various local people in the lodge and through word-of-mouth advertisement of the local people about the project. This part of the research was made much easier by the fact that Mongolian people are generally exceptionally hospitable and welcoming, and were extremely helpful in explaining and demonstrating day-to-day practices with wastewater management.

## **4.4 Quantitative Methods**

Quantitative methods were used in this study for the analysis of the tourists’ attitudes and perceptions on ecosan, and to collect data on the lodges. In order to interview tourists, a questionnaire with both open and closed questions was used (see Appendix 2), was used. Additional quantitative data was collected by a short questionnaire on the lodges in the Khuvsgul area (Appendix 3).

#### **4.4.1 Tourists' Questionnaire**

##### ***Data Collection***

For the interviewing of tourists, a questionnaire with 14 questions plus questions on personal data was developed. The questionnaire was pre-tested with several tourists in early June and then finalized. A total of 104 questionnaires were filled out. Most of the tourists were interviewed directly by the researcher, only a few filled out the questionnaire themselves (e.g., if there were several people at one time). Every person who was interviewed got a guided tour to the toilet and the trial garden and was explained the ideas and concept behind this urine-diversion toilet in depth. As most of the interviewees were on holidays and were generally quite interested in this new concept, an explanation with subsequent questioning could easily take half an hour. Thus, the data collection was much more time-consuming expected. Furthermore, tourists could only be interviewed in the morning or evening hours before or after they set out for their daily activities, which made a fast progress difficult.

##### ***Data Analysis***

A full data analysis was performed with SPSS® 13.0 and Microsoft® Excel XP. The analysis of the quantitative data is for the most part descriptive, and frequency distributions prevail. As all of the data had a nominal level of measurement, correlation or regression analyses were not possible. The results of the data analysis were graphically illustrated by using Microsoft® Excel XP.

#### **4.4.2 Lodges' Data**

In order to collect additional data that supplemented the interviews with the lodge owners, a short questionnaire on the lodges was created, containing information on the lodges' date of establishment, the number of tourists visiting each year, their current sanitary techniques etc. (Appendix 3). This questionnaire also served to get an overview of the development and structure of tourism on Lake Khuvsgul, data which was not available from other sources. In addition to the statistical data, the location of the lodges and other tourist infrastructure was indicated on a map.

##### ***Data Collection***

This short questionnaire was translated to Mongolian, so that the author could work independently. Like this, the data on an additional 18 lodges was collected (the same questions had previously been posed to lodge owners who had agreed to take part in the semi-structured interviews). The total number of lodges on which this data is now available is 36 out of 43.

##### ***Data analysis***

The data analysis was performed analogous to the methods described in chapter 4.4.1. Additionally, a map (Map 5) was drawn using ESRI® ArcGIS 9.2.

#### **4.5 Methods and Procedure for the Trial Garden**

In addition to being a scientific experiment on the effects of urine-fertilization and irrigation in the Khatgal area, the trial garden had – much more important – demonstrative and illustrating effects for the people involved in this study, be it lodge owners, local people, or tourists.

Through an extensive literary research and discussions with local experts<sup>16</sup>, the plant species for the trial garden were defined. These included the naturally occurring vegetation, alfalfa, oats and barley. All plants have been used in agriculture in Mongolia, though their prevalence has declined after the downfall of communism. Additionally, Siberian Sea Buckthorn was planted, but due to its slow growth, no experiments with visible results could be carried with this plant out within one year; this could be the focus of further research.

#### 4.5.1 Layout

The layout of the trial garden was designed in such a way that the influences of different amounts of water and fertilizer could be tracked. Nothing was sowed in row A; the natural steppe vegetation with various grasses and ambrosia was growing there. This allowed comparing the growth of the sown crops to the growth of the natural vegetation under the same conditions. In row B, alfalfa was sown – a plant that is traditionally used as animal forage in Mongolia. In rows C and D, oats and barley were grown – both cereals that are quite resistant to cold. While no earthmoving measures were carried out in row A, the grass was removed within the area for rows B, C and D, and the earth was dug up and loosened. In each row, there were six columns that each received different amounts of fertilizer (Fig. 7).

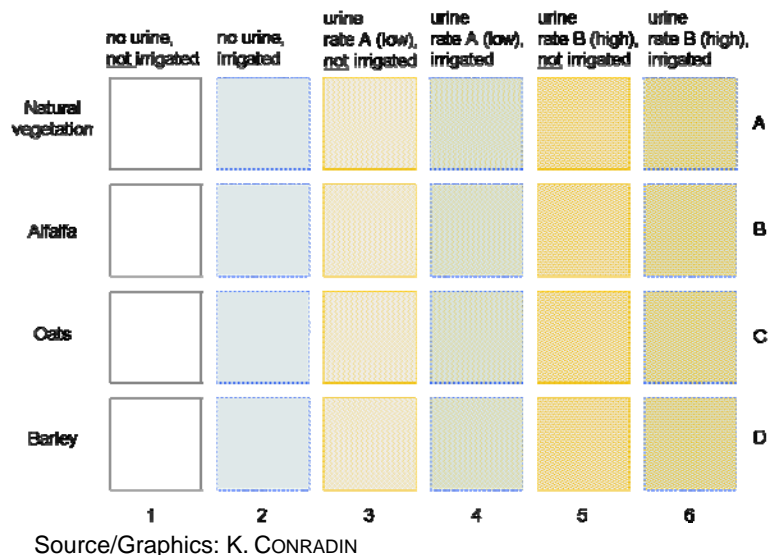

**Fig. 7: Layout and fertilizing plan for trial garden**

Four rows with different plant species, each containing six trial plots measuring 1x1 m, were created. The six resulting columns each received different amounts of fertilizer and/or water. While column 1 was a test column where there was no interference in the natural growth, column 2 was only irrigated. Columns 3 and 4 both received a low rate of fertilizer, but only column four was additionally irrigated. Column 5 and 6 received a high rate of fertilizer with only column 6 receiving additional irrigation. Like this, the influences of fertilization and irrigation could be clearly distinguished in each test plot.

For each plant species, there were six test plots measuring 1x1m. Like this, differences in growth and appearance not only between fertilized and non-fertilized crops, and depending on whether the plants were irrigated or not, could be discerned.

<sup>16</sup> Including Professor Suran of the Department of Biology, National University of Mongolia, Mr. G. Enkhtuvshin, Head of the Mongolian Organic Farmers Association and Mr. N. Battogtokh, president of the 'Holistic Management Centre', an environmental NGO.

#### 4.5.2 Fertilization and Irrigation

- The first two columns (No. 1 and 2) received no urine fertilizer at all, while the first one received nothing at all, and the second one was additionally irrigated when necessary.
- Column 3 and 4 received a low rate (A) of fertilizer, i.e., 1.5 L / m<sup>2</sup> per growing season (i.e., one year). Column 3 was not irrigated, and column 4 was irrigated when necessary.
- Column 5 and 6 received a high rate (rate B) of fertilizer, i.e., 6 L/m<sup>2</sup> per growing season (i.e., one year). Column 5 was not irrigated, and column 6 was irrigated when necessary.

Fertilizer was given in three doses at the beginning and in the middle of the vegetation period (dose one on June 14<sup>th</sup>, dose two on July 15<sup>th</sup>, and dose three on August 7<sup>th</sup>).

All irrigated columns received the same amount of water when they were irrigated. Fertilizer was diluted at a ratio of about 1:8 to prevent that the small plants were damaged. Accordingly, also those columns that were not irrigated received some water. This amount was however limited, as the fertilizer was given in three doses. Hence, these plots maximally received about 24 L/m<sup>2</sup> more water during the whole growth period than those test plots that were not irrigated at all.

#### 4.5.3 Documentation

The growth of each plant species within each plot was continuously analysed and documented photographically. At the end of the growth period, the plants were measured. In addition to this, soil samples were taken from each test plot to analyse the influences of the fertilization and irrigation on the soil characteristics (see VON ARX 2008).

## 5 RESEARCH AREA

The research area for this study lies in the north of Mongolia, in the Khuvsgul Province. Mongolia is located in the heartland of Central Asia and stretches between the latitude of 42° and 52°N and the longitude of 87 and 120°E. The surface area of Mongolia is 1'564'116 km<sup>2</sup>, which makes it almost five times as large as Germany (BLUNDEN 2004: 3). To the north, Mongolia borders on Russia, to the west, south and east on China. Politically, Mongolia is divided into 21 aimags (provinces); the capital territory of Ulaanbaatar city and the cities of Darkhan and Erdenet are municipalities with a province level status. The aimags are again subdivided into soums (rural districts), and these again into baghs (communities) (IBID.: 10f). The population of Mongolia was estimated to be 2.95 Mio. in 2006 (CIA 2007, Internet), which makes it the most scarcely populated country on earth (1.9 inhabitants per km<sup>2</sup>). The country can be divided roughly into three ecological zones: barren drylands and the Gobi desert cover the southern third of the country; the central areas are mainly dominated by steppe, and the northern provinces Khuvsgul, Bulgan, Selenge and Khentii contain some of the few forests of the country.



Source: Adapted from CIA 1996, Internet

### Map 2: General map of Mongolia

Mongolia lies in the heartland of Central Asia between Russia in the north and China in the south. The country is divided into 21 aimags (provinces), the cities of Erdenet and Darkhan, and the capital territory of Ulaanbaatar. The research for this study took place near Lake Khuvsgul in the Khuvsgul Province in Northern Mongolia.

The Khuvsgul aimag, on which this study is focused, is the northernmost province in Mongolia, bordering on the Tuvan and Buryat republics of the Russian federation. Its surface area is 100'600 km<sup>2</sup>, and its population 124'500 (BLUNDEN 2004: 307).

## 5.1 Physiogeographical Aspects

Khuvsgul aimag is named after Lake Khuvsgul, the largest lake in Mongolia in terms of volume: the lake is 136 km long, 20 to 40 km wide and about 260 m deep (TUMURTOGOO, KARABANOV & MONGONTSETSEG 2006: 1). It contains roughly 1% of the world's surface freshwater (HARPER, GRUIS & BROWN 1998: 11). The lake lies at an altitude of 1648 m and is ultra-oligotrophic. There are 96 permanent or temporary flowing tributary streams entering lake Khuvsgul, and one outflow, the Eg river (GOULDEN ET AL.2006: 1ff.).

Lake Khuvsgul lies at the southern end of the Baikal rift system. This system began to form following the collision between the Eurasian continent and the Indian sub-continent. It is estimated that the lake has begun to form some two to five million years ago.



Source: Adapted from HEAD OFFICE OF GEODESY AND CARTOGRAPHY OF THE USSR 1983

### Map 3: Topographical map of the Lake Khuvsgul area

The northern part of the Khuvsgul Province is dominated by Lake Khuvsgul. To the west of the lake lay the Khoridol Saridag Mountains which slope down to the Darkhan Depression. To the north, the Sayan Mountain range forms a natural border to Russia. The landscape east of Lake Khuvsgul is dominated by forested hills. The border of the National Park is roughly outlined in red.

The western and northern parts of the Khuvsgul region are rather mountainous, with peaks between 2500 and 3000 m above sea level. In the north, the Sayan range forms the border



to Russia. Its highest peak is the Munkh Saridag Mountain with 3491 m. West of Lake Khuvsgul lie the Khoridol Saridag Mountains which slope down westwards to the Darkhan Depression with an intricate system of wetlands and lakes. To the east of the shore lies a more gentle, rolling landscape of mixed forest and steppe grassland. The steep mountains to the west are uplifted dolomite; the gentler terrain to the east resulted from volcanic activity (CONSERVATION INK 2004). In the southeast of the province, the larger rivers of Ider, Delger Muren and Eg all join the Selenge River; this river is the major river draining north-central Mongolia and eventually flows into lake Baikal.

The areas around Lake Khuvsgul are underlain by discontinuous permafrost. The active zone thickness (the zone of surface soil that melts each summer) ranges from 3.5 m at Khatgal in steppe to approximately 1 to 1.5 m on north-facing slopes and some valley bottoms in forested areas (GOULDEN et. al. 2006: 13).<sup>17</sup>

### **Vegetation**

The Lake Khuvsgul area lies at the southern border of the taiga forest. To the south of the Lake Khuvsgul basin, forests are usually restricted to the northern slopes of the hills (see Photo 9). These forest patches are surrounded by steppe vegetation and form the transition between the taiga to the north and the steppe to the south. In contrast to this, around Lake Khuvsgul and north of Khatgal, forests are more dominant. They generally surround meadows on the lower south sides of the mountains; the higher parts of the dolomite mountains are mostly barren. Farther to the north, forest covers both south and north slopes. The forests primarily consist of Siberian larch, with few pines, birches, aspen, and willows close to riverbeds. The meadows are a habitat for a number of alpine flowers (Photo 10).



Photo: K. CONRADIN

#### **Photo 9: Forests on north slopes of mountains**

South of the Lake Khuvsgul basin, forests are usually limited to the north slopes of mountains, and surrounded by steppe vegetation.

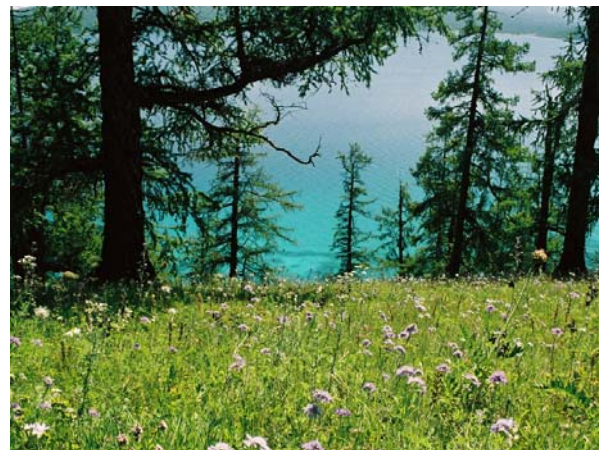

Photo: M. KROPAC

#### **Photo 10: Alpine meadow surrounded by larch**

Around lake Khuvsgul, small alpine meadows are surrounded by larch forest; forest also grows on south facing slopes.

<sup>17</sup> For a more detailed account on the geography and geo-ecology of the area, see VON ARX, J. (2008): Geo-ecological Research in the Khuvsgul Area, Northern Mongolia. Master Thesis (in German). Department of Geosciences, University of Basel.

### **Climate**

The climate in the Khuvsgul area is extremely continental, with short warm summers between June and August, short falls and springs and long, cold and dry winters in which temperatures can plunge to  $-40^{\circ}\text{C}$ . Due to the high elevation, the average temperature remains below zero from October until May, and even the average July temperature is only  $10^{\circ}\text{C}$ . High winds, especially in spring, cause dust storms and cold northerly winds can cause temperatures to drop below freezing even in mid-summer. At higher elevations, snowfalls can occur in any month of the year. The short rainy season lasts from mid-July to September, and most of the annual precipitation falls then. During that time, heavy rains can cause mudslides and flooding (HARPER, GRUIS & BROWN 1998: 11). The average precipitation in Khatgal is roughly 300 mm, the average annual temperature  $-4.9^{\circ}\text{C}$  (GOULDEN ET AL. 2006: 11).

### **Soil Cover**

The soil cover in the Khuvsgul area is quite diverse “because of mountainous features, differences of exposure, the influence of permafrost, the forest and the soil-forming sediments” (BATKHISHIG 2006: 93). In general, the soil cover is not very thick. Kastanozems, Parachernozems, Gleysols, cryomorphic soils and Rendzinas are the predominant soil types.

### **Research Area Location**

The actual research area was located at the southern end of Lake Khuvsgul. It included the western shore of Lake Khuvsgul up to about 35 km from Khatgal, the area around Khatgal, and the very southern parts of the eastern shore. These are the main areas where the lodges are located (see also Map 5, p.55).

### **National Park**

Lake Khuvsgul National Park was established in 1992. National Parks within Mongolia denominate “places of historical and educational interest; fishing and grazing by nomadic people is allowed and parts of the park are developed for tourism” (KOHN 2005: 41).<sup>18</sup> In 1997, the park was expanded on its south-western side by the Khoridol Saridag Strictly Protected Area. Today, it covers an area of 1’026’704 ha, the entire watershed of the lake, (CONSERVATION INK 2004) and hosts a wide variety of animals and plant species, some of which are endemic.

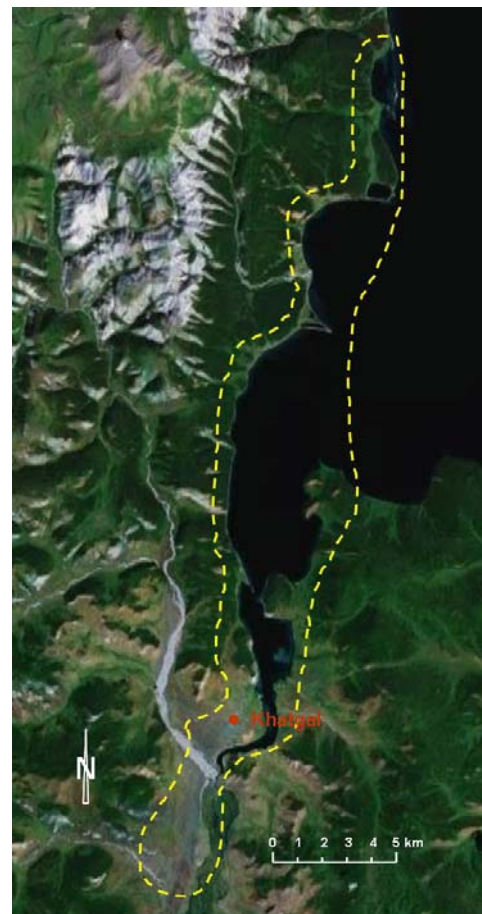

Source: GOOGLE EARTH, OCT. 25<sup>th</sup> 2007

Graphics: K. CONRADIN

#### **Map 4: Map of the research area**

The research area included the town of Khatgal, the western shore up to about 35 km north of Khatgal, and parts of the eastern shore in the very south of Lake Khuvsgul. These are the areas where the bulk of the lodges are situated.

<sup>18</sup> In contrast to this, strictly protected areas shelter “very fragile areas of great importance; hunting, logging and development is strictly prohibited and there is no established human influence” (KOHN 2005: 41).

## 5.2 Socio-Cultural Aspects

Khuvsgul is a rural province where most of the income is generated by animal husbandry and timber industry (BLUNDEN 2004: 307) Three quarters of the population still live in rural areas (NSOM 2003: 34). The aimag capital is Muren, a town with about 35'000 inhabitants. The small town of Khatgal, the centre of the research area, lies about 100 km north of Muren.

### ***Development***

Khatgal was founded in 1727 as a camp for Manchu Soldiers defending their territory against Russia. In 1911, the first steamship began operating, and the village became an important port town. During the Soviet Rule (from 1924 to 1990), a large part of the international trade with Russia was carried out over Lake Khuvsgul, in summer by boat, and in winter with trucks over the frozen lake (HARPER, BROWN & GRUYS 1998: 14). Alongside this trade, industry was developed: Khatgal had a brick and a wool-washing factory, several warehouses, a hospital, and was connected to electricity and telephone. The population peaked at about 10'000 in the late 1980s (ENKHTAIVAN 2007). During this time, large areas were deforested to meet the high energy demand of the local industry. With the downfall of communism, both trade and industry collapsed. Nowadays, only crumbling ruins and old chimneys rise up into the sky; electricity and private telephone connections are no longer available. The population sank drastically and currently lies at about 2'700 (BATBOLD ET AL. 2004: 16). Recently, Khatgal has gained importance through the development of tourism.

### ***Livelihood***

After the collapse of the Soviet Union, many people lost their jobs, and Khatgal now features a high unemployment rate (GANBAATAR 2007). The primary sources of income are animal husbandry and government services (HARPER, BROWN AND GRUYS 1998: 21). Most of the local families own at least some animals (e.g. yaks, cows, sheep or goats). Some own summer houses (wooden sheds) outside of Khatgal, or move to the countryside with their gers in the summer to find additional grazing grounds for their animals. However, the number of livestock in the immediate surroundings of Khatgal is rather high; it causes soil degradation and prevents the re-growth of young trees in the forests. In order to supply additional fodder to the animals in the winter, hay is cut at the end of summer in the meadows around Lake Khuvsgul.

### ***Environmental Consciousness***

Traditional Mongolian belief considers water as sacred. The pollution of water is regarded as an offence to water spirits, and many legends and folk tales revolve around this subject. This belief probably springs from the fact that many parts of Mongolia are dry, and as nomads, people have to deal wisely with water. Yet, surprisingly, this does not prevent the pollution of water sources in general. Rivers and water sources close to cities are usually heavily polluted. A quote from A. SCHENK<sup>19</sup>, illustrates this: "Mongolians generally lack consciousness for their surrounding environment: Though they have a passion for their sites of natural beauty and sing countless songs about them, environmental sins are hardly ever rated as such" (2006: 165).

---

19 Amélie Schenk is a Swiss Ethnologist who lived in Mongolia for many years.

### **Tourism in the Lake Khuvsgul Area**

After the downfall of communism, tourism got increasingly important in the Lake Khuvsgul area. The number of tourist has continuously risen since then, but has only significantly developed after the year 2004, when the country recovered from a severe economic crisis in the 1990s (due to the abrupt change from communism to a free market economy) and when the SARS (Severe Acute Respiratory Syndrome) epidemic was overcome. While only approximately 32'000 tourists visited Mongolia in 2001 (ROSSABI 2005: 88), the number has risen to 385'000 in 2006 (MINISTRY OF ROAD, TRANSPORT AND TOURISM 2006, Internet). The number of tourists visiting Mongolia each year is growing by 15 to 20% each year (IBID.)

The same development can be observed in the Khuvsgul region and can be illustrated by the establishment of lodges on the shores of Lake Khuvsgul. Until the year 1990, only two lodges existed in the Khatgal area. Between 1991 and 2000, another six lodges were built, while the last six years (from 2001 until 2007) brought a total of 28 (!) new lodges into the area (OWN SURVEY 2007). The development of tourist infrastructure seems to be largely unrestricted, with lodges being established more and more directly on the shores of the lake (see Map 5 on the following page).

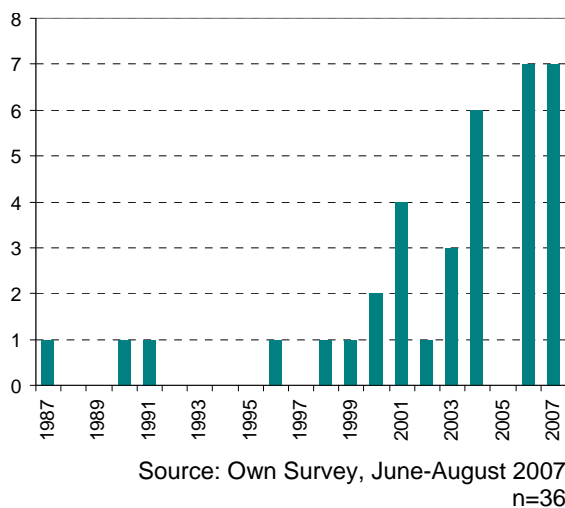

**Fig. 8: Newly established lodges per year in the Lake Khuvsgul area since 1987**

The number of newly built lodges has increased significantly since the year 2000. Half of the tourist accommodations that currently exist in the Khuvsgul area were built in the last four years.

While it is clear that the number of tourists has grown in the Khatgal area, it is not clear whether the number of lodges increases in accordance with the development of tourism, or whether far too many lodges are being built. Based on the observations in summer 2007, the latter seems to be more probable: almost half of the lodges accommodate fewer than 200 tourists per year (OWN SURVEY 2007), and only a very small number of well developed ger camps accommodates the main share of tourist.

It is hard to get figures on the number of tourists visiting the Lake Khuvsgul area. The only source of information is the log-book at the entrance of the national park, but not all tourists are registered and the control is very lax; it remains unclear whether tourists who arrive by plane (and therefore do not pass the entrance post) are even registered at all. This log-book states that about 8'000 tourists visited the area in 2004, about 6'000 in 2005, and about 9'000 in 2006; usually, around 60% are domestic tourists. The estimations of the lodge owners add up to about 10'000 tourists for the 2007 season<sup>20</sup>, but this is only a very rough indication. Though they are only approximations, these figures make clear that tourism has become more and more important in this area. There is no indication that this trend will stop or slow down in the next few years. Considering this, it is crucial to initiate a development of ecologically friendly and sustainable tourism as soon as possible.

<sup>20</sup> This does not include people who camp.

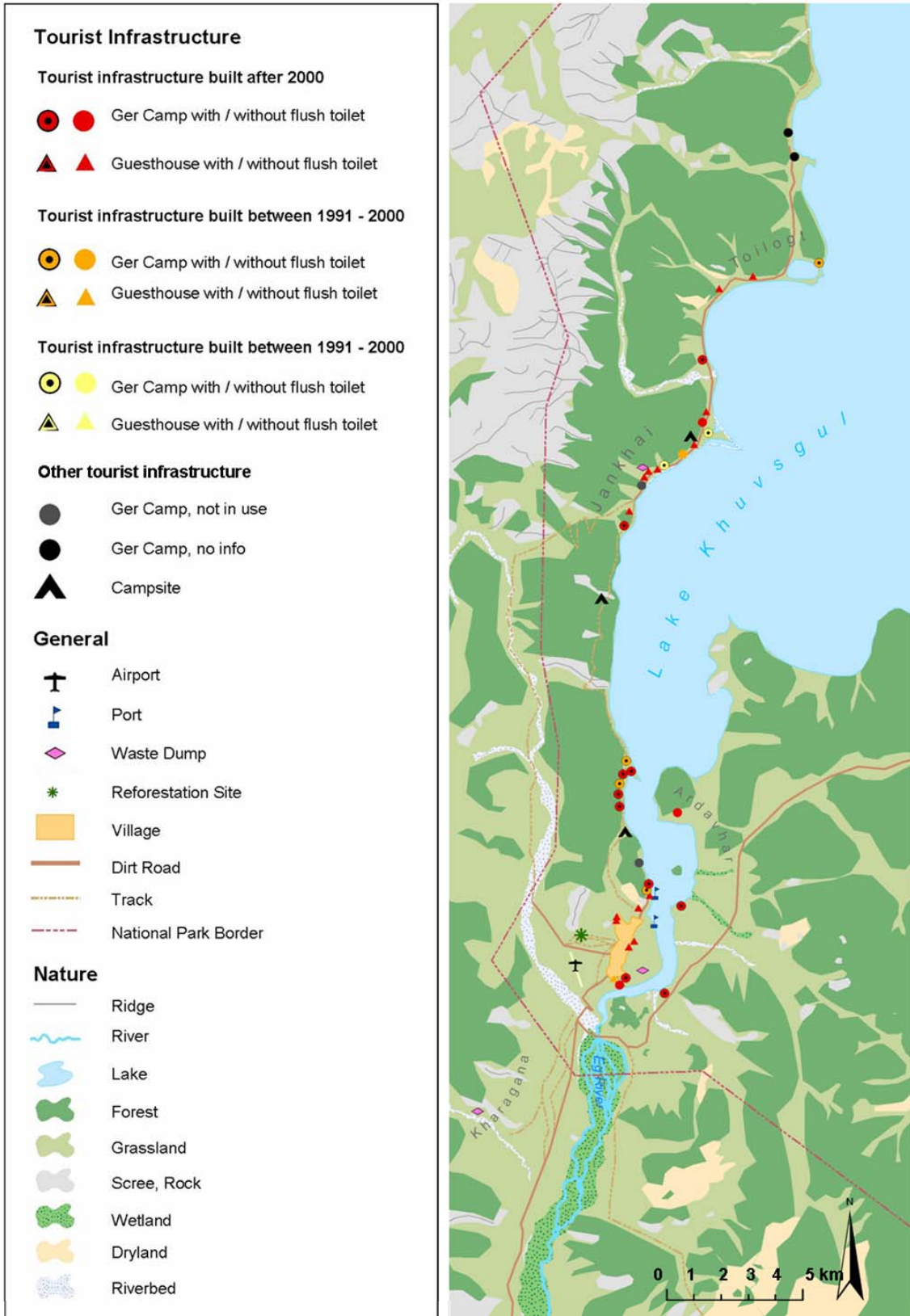

Base Map: GOOGLE EARTH, OCT. 31<sup>ST</sup>.2007

Cartography: K. CONRADIN

**Map 5: Research area and tourist infrastructure**

The above map shows the research area in detail, including the locations of the ger camps (circles) and guesthouses (triangles) researched for this study, place names, waste dumps, and general infrastructure. The colours yellow, orange and red indicate the time when the tourist infrastructure was built: the darker the colour, the more recent the development.

## 6 KHUVSGUL INN ECOSAN PILOT-PROJECT, KHATGAL

Current practices of wastewater management in the Khatgal area are not sustainable, and there are inherent risks not only for water pollution, but also for the attractiveness of Lake Khuvsgul National Park as such. Deplorably, most lodge owners are not aware of more suitable alternatives. However, the operators of Khuvsgul Inn, a relatively new lodge at the southern end of Lake Khuvsgul, broke new ground this summer and built a UDD toilet based on the ecosan concept. After the author and Mr. Madin had got to know each other, the plan for the toilet was refined and adapted more closely to the ecosan concept during winter and spring 2007. The toilet was built at the beginning of June 2007.

### 6.1 Design

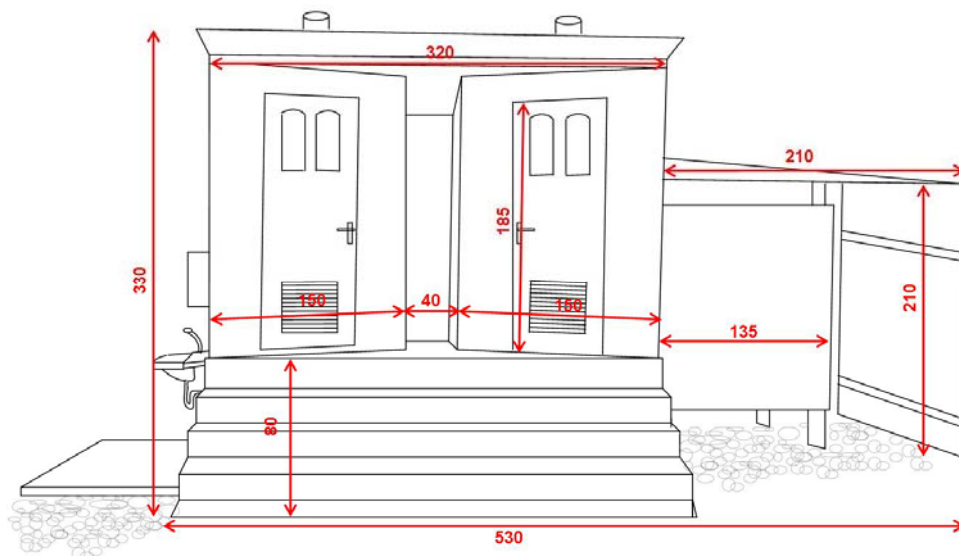

Source: K. CONRADIN

**Fig. 9: Front view of the toilet at Khuvsgul Inn (plan)**

The UDD toilet at Khuvsgul Inn was built entirely above ground level; this makes it much easier to remove urine canisters or faeces containers. After the toilet was built, a urinal for men was added on the right side. The sink for hand washing is located on the left side (water brought by bucket). Red figures indicate the measurements in centimetres.

The toilet at Khuvsgul Inn is built entirely above ground; no digging is required. Thus, it is much easier to perform maintenance operations such as emptying the urine containers. To the left of the toilet, a sink with a small water container for washing hands was mounted, to the right, a men's urinal was added. The toilet was built entirely out of wood, which is locally available and inexpensive (for Photos, see page 58f.).

Urine flows down the toilet and in a short pipe or hose into the closed 20 L collection container. This was emptied regularly and transported into larger barrel, where the urine was stored for some weeks to further hygienise it. Faeces fall down directly into the metal bins that are placed below the toilet. If the faeces container is full, it is pushed to the back and a new container is placed under the toilet. No new faeces are added to the full container, and the contents are allowed to dehydrate completely. By means of this procedure, it is not

necessary to build two vaults for dehydration<sup>21</sup>. At this stage, it cannot be said exactly how long the hygienisation will take in this specific project; however, the WHO guideline recommends storage for at least one year to render the product sufficiently safe for further handling. Samples should then be taken to determine the need for further storage or a secondary treatment in order to get a hygienic end product (Fig. 10).

Each storage compartment contains a chimney for aeration. The back of the toilet faces southwards;

both the chimneys and the lids of the storage compartments are painted in black so that they absorb as much solar heat as possible. This accelerates in the drying process. Additionally, when the chimney is warmed up, air rises in it. The toilet

cubicle is more or less airtight except for the louvers in the door. If air rises in the chimney, there is a slightly lower pressure in the storage compartment. Consequently, air is sucked through the louvers, down the toilet and up through the chimney. This prevents smells in the toilet, transports humidity out of the collection chamber and hence speeds up the dehydration of the faeces (Fig. 11).

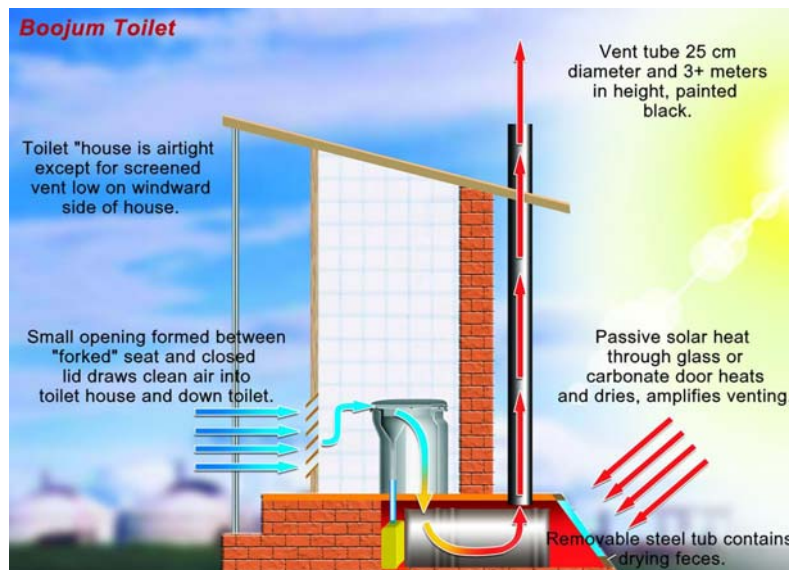

Graphics: BOOJUM EXPEDITIONS

**Fig. 11: Cross section of the toilet at Khuvsgul Inn**

The back of the toilet faces south. Through solar energy, the storage chamber and the chimney are warmed up. Warm air rises through the chimney, cold air is sucked through the louvers in the door and down the toilet (the cubicle is more or less airtight otherwise). This prevents smell in the toilet and aids the dehydration process.

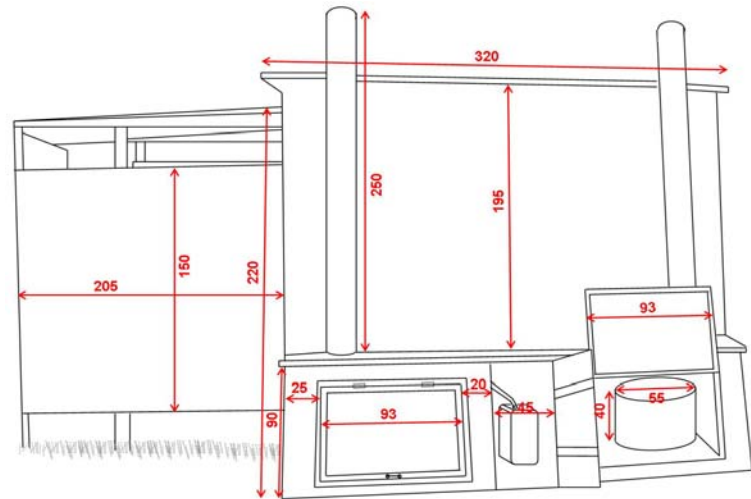

Graphics: K. CONRADIN

**Fig. 10: Back view of the toilet at Khuvsgul Inn (plan)**

While urine is collected in two canisters in the middle storage compartment (the urine flows into the canister through a short pipe), faeces fall into the metal bins. The backside of the toilet faces south. Red figures indicate the measurements in cm.

The floor of the storage compartments is cement-lined. On the one hand, this

<sup>21</sup> Normally, a UDD Toilet is built with two vaults; if one vault is full, it is locked and left untouched until the faeces are hygienised. Either, there has to be a movable toilet seat, or two cubicles have to be constructed which are used alternately. The solution with a movable container makes this unnecessary.

prevents humidity from entering the dehydration chamber from the ground (i.e. when it rains) on the other hand, it makes the infiltration of liquids into the soil impossible.

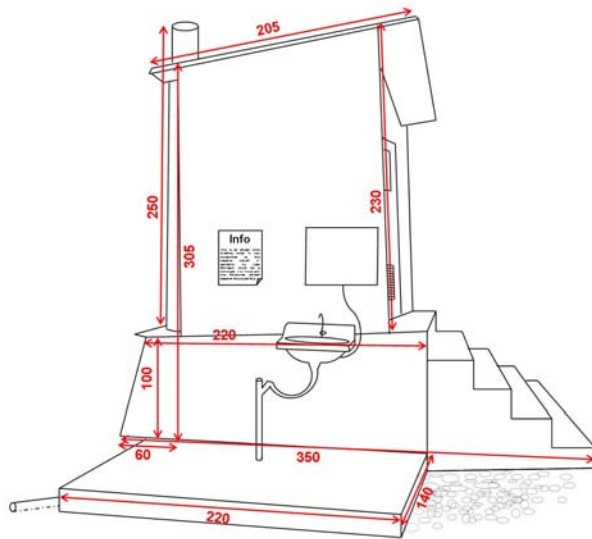

Graphics: K. CONRADIN

**Fig. 12: Side view of the toilet at Khuvsgul Inn (plan)**

A sink for hand washing was attached to the left side of the toilet. Water was filled by bucket in the small tank. This greywater was infiltrated the ground with a drainage pipe. Next to the sink, information on the toilet was posted.

Both the roof and the floor of the toilet are sealed to make it waterproof, and the wood is lacquered to make it more weatherproof. To the left of the toilet, a sink for washing hands is attached. The water is provided in a small tank which is refilled by hand. This greywater directly infiltrates the ground with a perforated pipe about 3 m long. The ditch for the drainage pipe was filled with gravel to prevent the clogging of the holes. Next to the sink, information leaflets on the toilet in particular and on ecosan in general were attached.

Similarly, people were informed about the proper usage of the toilet in the toilet cubicles, where a sign with rules was hung. It was explained that it is necessary to sit down to allow for a complete separation of urine and faeces, that paper needs to be thrown in a waste bucket because it would not decompose in a dehydration toilet, that no liquids should be emptied in this toilet, and that some ash should be sprinkled over the faeces to help the hygienisation process.



Photo: K. CONRADIN

**Photo 11: Front view of the ecosan toilet**

The ecosan pilot project toilet comprises two cubicles and a men's urinal. The sink is located on the left side. The design of the toilet is relatively simple; it was built by one carpenter and several local labourers in about five days. The whole toilet is built entirely above ground and primarily made from locally available material.





Photos: K. CONRADIN

**Photo 12: Back view of the ecosan toilet**

The back of the toilet faces south. Both the chimneys and the storage compartment lids are painted in black so that they absorb a maximum of the solar heat.



**Photo 13: Back view of the ecosan toilet, close-up**

Urine is collected in 20 L containers, faeces fall into the black half-barrels, where they are left to dry. The floor of the storage compartment is lined with cement.



Photos: K. CONRADIN

**Photo 14: Separating seat**

In a separating seat, urine is collected in a funnel in the front and lead away with a hose, while faeces fall down in the back.



**Photo 15: Toilet cubicle**

The air goes down through the forked seat and is pulled up the chimney by thermal processes. This prevents smell and aids the drying process (see Fig. 11).



**Photo 16: "Flushing" with ash**

A cup of ash is added to cover the faeces and prevent vectors to land directly on them. Ash raises the pH of the faeces and thus helps in the hygienisation process

## 6.2 Cost

The costs for the materials of this pilot project toilet were recorded in detail. Naturally, they are higher than the usual costs for a toilet in serial production. The toilet was specifically made look very nice so that the people who used it (both tourists and local people) would get a good first impression of this previously unknown concept. This inevitably made the toilet more expensive. It would without doubt be possible to cut down the costs substantially if only a very basic model of a UDD toilet was built.

### **Material**

The total cost for the material of the whole toilet with two cubicles was 1'247'700 MNT (roughly 730€). This price comprises all the materials. The seat for the pilot project toilet was

imported from South Africa, as no suitable separation seats were available at the time of planning in Ulaanbaatar. While the heavy materials (such as wood, cement, metal barrels etc.) were bought in Muren, more sophisticated parts (prefabricated doors, tiles, chimneys, sinks etc.) had to be brought from Ulaanbaatar. However, for a simple toilet, all materials, except for a prefabricated seat, would be available on the market in Muren. Presumably, the material for a toilet with one cubicle could be built for about roughly half the price of the double toilet (ca. 365€).

### Labour

The costs for the labour were insignificant in comparison to the total costs of the toilet. Roughly five people worked on this toilet for about five days. Some of these workers were hired for the whole summer by the lodge; the work they contributed to the toilet was included in their monthly wage. Unskilled labourers who aided in the construction usually earn about 5'000 MNT per day.

## 6.3 Concept

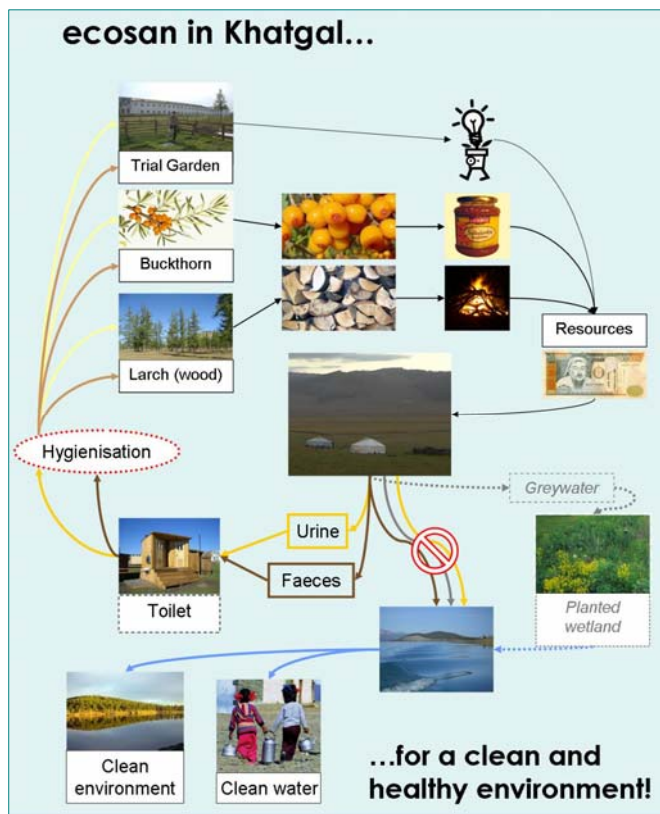

Graphics: K. CONRADIN

**Fig. 13: The ecosan loop for Khatgal**

This locally adapted ecosan reuse cycle was used to inform the toilet visitors about the toilet's benefits for the environment and the possible reuse ways for ecosan fertilizer.

and for the reforestation project in the future. Sea buckthorn was only fertilized at a very low rate this year. It does generally not react well to nitrogen fertilizer and could be better fertilized with hygienised faeces in the following years.

After the urine was collected and hygienised through storage, it was reused in various ways: The trial garden mainly had demonstrative effects but also served to prove the effectiveness of urine fertilizer in this area (see 8.4). The fertilization concept for trees was developed during the actual research time, when it was recognized that there was a large need for reforestation, and when it was clear that this reuse option enjoyed a high acceptance among all user groups. Hence a small reforestation project was initiated by J. von Arx and the author (see Appendix 5). The planted trees on an area of 800 m<sup>2</sup> were too fertilized with urine from the ecosan toilet. Faeces were not used this year, as they first have to dehydrate completely; this will take at least until next year. Presumably, they will be used both for a small sea buckthorn plantation in the compounds of the Khuvsgul Inn,

## 6.4 Problems and Suggestions for Improvement

The toilet built in Khuvsgul Inn is the first of this kind in the Khatgal area. Out of the problems during the first season of operation, suggestions for improvement could be deducted.

### **Watertightness**

During the first few weeks in operation, the toilet worked fine, though there was more liquid in the left faeces container. After two or three days with heavy rainfall, there was even more liquid in the toilet, and it was found out that the water entered the storage compartment through cracks in the wooden floor. This problem did not occur in the right storage compartment. It is thus necessary to improve the left compartment by making it completely watertight. Similarly, the chimneys of the storage chamber should be capped off against rain.

### **Faeces Container**

During the operation, it became obvious that the faeces container could be improved in order to create more favourable conditions for drying. Currently, it is a metal barrel cut in half, with a volume of roughly 95 L). Aeration is only possible from above. While the barrel as such is a good idea, as it is a simple and economic adaptation of the two vault concept normally applied for dehydration toilets, it could be improved to facilitate a faster drying process.

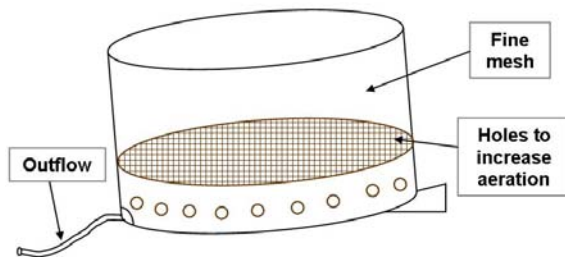

Graphics: K. CONRADIN

**Fig. 14: Improved faeces storage container**

In order to allow for a better and faster dehydration of the collected faeces, some adaptations in the design of the current method are necessary. The container could be retrofitted with a mesh and holes could be drilled in the side. A little hose or drain would allow potential liquid to infiltrate the ground.

In order to increase the airflow, the container should be retrofitted with a small mesh some centimetres above the bottom. In between the bottom and the mesh, holes that measure a few centimetres should be drilled to allow the air to circulate below the mesh. A small hole at the bottom of the container that is slightly raised on one side could be connected to a hose that leads out of the storage compartment into the soil, and potentially emerging liquid could be infiltrated<sup>22</sup>. It is important that the infiltration takes place below

the surface of the ground, in order to make it more hygienic. Alternatively, there could be a small drain in the cement lining of the storage chamber, where potentially emerging liquid could be drained away. This system would be similar to the design developed by the GTZ (see 3.4.2); good results were yielded with this.

### **Further Adaptations**

- The chimneys should be retrofitted with fly screens so that no flies can enter the processing chamber.
- In the first weeks, some problems concerning the cleaning emerged. The staff must clearly understand the functionality of the toilet, and that as little water should be used for cleaning as possible.
- Also the staff should use the ecosan toilet, the pit toilet should be eliminated.
- In a next model, the stairs should have wider steps and should be less steep.

<sup>22</sup> As these are only minimal amounts, this is not problematic from a hygienic point of view.

## 7 CURRENT WASTEWATER AND WASTE MANAGEMENT

In order to judge the potential of ecosan in the Khuvsgul area and to fully understand the results of the acceptance study, it is necessary to get an understanding of how sanitation and related issues are currently dealt with. This chapter shall give this overview. At the same time, it supplies information that is crucial to understand the respective research group's attitude towards new sanitation technologies.

### 7.1 Lodges' Current Sanitation Technologies

The largest share of the lodges (without low-budget accommodations) in the Khuvsgul area has flush toilets; the less upmarket accommodations usually have conventional pit latrines that are both used by tourists and staff. The data presented here stems from an own quantitative survey (see Appendix 3) with 36 of the totally 43 lodges, and from observation.

#### 7.1.1 Regulatory Framework

In order to legally operate a tourist lodge, certain sanitation standards have to be fulfilled. The current sanitation standard for the Khuvsgul area obliges lodges to collect all wastewater – i.e., both greywater and blackwater (see also Box 2) – in holding tanks. The toilets and holding tanks must be located at least 300 m away from the shoreline of the lake (OTGONBAYAR 2007). According to the environmental inspector of Khatgal, Mr. Batbayar, this regulation exists since the beginning of this decade and was recently replaced by more stringent requirements to the effect that holding tanks now either have to be made out of cement, or the metal holding tanks have to be placed within a cement lined container (BATBAYAR 2007). Unlined pit toilets are not a legal option for lodges. Nevertheless, this regulation does not necessarily imply that the lodges have to have flush toilets; it is merely a regulation that the wastes have to be collected and prevented from infiltrating the ground. However, hardly any of the more upmarket ger camps provide their guests with dry toilets; they mostly opt for flush toilets. Yet, the regulation is generally not implemented for smaller lodges and budget guesthouses: they mainly have conventional pit latrines and only few of them have holding tanks.

#### 7.1.2 Current Practices

In summer 2007, there were a total of 43 lodges in the Khatgal area, of which four were not in use. There were a total of 19 ger camps and 17 guesthouses.<sup>23</sup> Almost half of the tourist lodges have flush toilets (44%), about 40% have conventional pit latrines. If just talking about the more upmarket ger camps, then the figure is much higher: 85% of the ger camps have flush toilets. Similarly, the figure is higher for pit latrines if only analysing guesthouses: 77% of the guesthouses use exclusively this kind of toilets.

---

<sup>23</sup> When talking about tourist infrastructure, 'lodges' is used as the general term for all tourist accommodations. Ger Camps denominates the more up-market camps where tourists sleep in individual gers. Ger camps are larger in size (here: up to 27 gers) and include services such as own restaurants, hot showers, and sometimes sauna. Guesthouses, on the other side, are smaller (here: max 7 Gers), with a limited range of services, and usually also offer dorms to sleep in. Gers are usually shared with other tourists.

Three lodges (8.3%) currently have compost toilets, which consist of simple metal barrels placed under the toilet seat; urine and faeces are covered with sawdust. However, composting is not done properly, and the content of the barrels is, just as the wastewater of other lodges, transported to the central dump; the composting process is not finished at this point. Environmental and hygiene inspectors do currently not allow it to reuse this compost in any way.<sup>24</sup>

Those who rely on flush systems pump the water from the lake into elevated tanks; it is then further distributed by gravity. The generated wastewater is collected in holding tanks, their contents are regularly emptied by tanker trucks. The wastewater is brought to the central waste dump in Kharagana, about 8 km south of Khatgal. Those lodges which do not use flush toilets usually also rely on the wastewater truck, because the greywater from showers has to be carried away. Only low-budget accommodations such as small family-run guesthouses neither have a holding tank for black- or greywater (33.3%).



Photo: K. CONRADIN

**Photo 17: Wastewater truck**

One of the two wastewater trucks used in Khatgal. The capacity of one of these trucks is about 4000 L.

This practice of transporting the wastewater away from the lodges to a central dump is a better solution than just letting each lodge infiltrate its untreated wastewater on site – however, it is not sustainable and could be greatly improved. In fact, the current practice generates considerable costs for the lodges:



Photo: K. CONRADIN

**Photo 18: Water transport in Khatgal**

Some lodges still get their water for showers and toilets by horse cart. Here, water is filled into the elevated container by hand.

Of those who could give an indication on how often the wastewater truck pumps out their wastewater, almost half (45%) said they have to do so once a week or more often. Still another fifth has to pump wastewater more than once a month; the other 40% about once a month or less. The costs for one transport are between 30'000 and 80'000 MNT (ca. 20 to 50€) for a load of roughly 3'500 L (the average capacity of a wastewater truck), depending on how far the lodge is located from the dump. This amounts to considerable costs: on average, the lodges that took part in this survey spend more than 500'000 (ca. 300€) MNT every season just for wastewater transport; a significant amount of money in Mongolia, especially for smaller lodges! This is a very conservative estimation that was

<sup>24</sup> The toilet in Khuvsugul Inn was officially approved by the National Park authorities and hygiene inspectors. However, the general reuse of sanitised urine and faeces is not yet part of an official standard.

calculated with the lodges' own indications of how often they use the wastewater truck per season, figures that often seemed very low and sometimes even implausible.

To these costs, water costs are added. This is especially expensive for those lodges that are not located directly on the shoreline and cannot pump their water from the lake. One barrel (about 200 L) of water currently costs about 500 MNT; the water is usually transported by horse and filled into the elevated containers by hand; a very laborious process. If the lodge uses flush toilets, substantial amounts of water have to be transported every day.

Despite the current regulation, almost all lodges (94.1%) still have a pit latrine for their staff and for the winter. The standard obviously just applies to tourists' toilets. Considering the low utilisation of some of the lodges, and the relatively high number of staff working in each lodge, more excreta might actually accumulate from staff (who is there all summer) than from tourists who only stay in the lodge for a few days. As most lodges are located relatively close to the lake, the infiltration of pollutants and pathogens may actually pose a problem despite the regulatory standard for tourists' toilets. Research by OYUNMUNKH (2008) on the water quality of Lake Khuvsgul has for instance shown higher levels of ammonia close to some lodges.

The largest amount of the lodges' greywater is collected in holding tanks and transported to the dump. However, most lodges do *not* dispose of the *kitchen* greywater in the holding tanks, but just pour it in the worker's pit latrines or in the nearby forest. This might be due to the fact that greywater collection tanks are usually located close to the showers and toilets, and not to the kitchen. Most lodges do not have running water in the kitchen, and thus also no pipe connections that lead to the holding tank. The greywater would consequently have to be transported by hand to the holding tanks (which are usually underground), but it is often easier and more convenient to just dispose of the greywater in a spot close to the kitchen (such as staffs' toilets). Though it is not a very big environmental issue if the greywater is discharged on a meadow or in the forest, it is problematic if large amounts of greywater are discharged into pit latrines, as this significantly increases the infiltration rate.



Photo: K. CONRADIN

**Photo 19: Emptying of greywater in existing pit latrines**

In lodges, kitchen greywater is often emptied into the staff's pit toilet (here) or just disposed of in a nearby forest in the absence of a soak pit; families do the same with their greywater.

### 7.1.3 Problems Resulting from Current Practices

There are several consequences of this current system:

- **Illegal dumping:** It is likely that not all of the collected wastewater is discharged where it should be. There is quite a high incentive for truck drivers to get rid of the heavy load somewhere in a hidden in the forests instead of driving with a fully loaded truck all the way to the dump. Drivers are paid in advance; if they do not transport the full load to the dump, they can save a lot of gasoline, i.e., money. This concern was raised by several interviewees (both lodge owners and local people). Furthermore, lodge owners might

purposely have leaking tanks in order to reduce the costs for the wastewater transport. Recently, controls are more restrictive: There were cases when lodges were closed by inspectors due to leaks in their wastewater holding tanks (KHATGAL COMMUNITY MEETING 2007a), but all in all, not much is being done to prevent these illegal activities

- **Soil degradation:** The transport of wastewater in trucks on virtually non-existent roads is a major cause of soil degradation. The trucks are much heavier than conventional vehicles and consequently cause greater degradation (erosion, soil compaction, see Photo 20). The transport of wastewater alone makes several hundred journeys necessary every year in this fragile environment.

- **Limited suitability:** There are a few lodges that open for some time during the winter, especially for the ice festival that is held in January or February each year. Lodge owners complained that they cannot use their current systems in the winter, because all the pipes freeze. Tourists then have to use the conventional pit latrine. A technology that could be used all year round would improve this situation.



Photo: B. OYUNMUNKH

**Photo 20: “Road” at the western shore of Lake Khuvsgul**

The “road” at the southern end of Lake Khuvsgul is in extremely bad condition. Due to this, it is much wider than it would actually need to be. This leads to increased soil erosion, especially when it rains during summer and when the traffic is at its high point at the same time. Transport of wastewater contributes a considerable part to this problem.

- **Flooding / Permafrost:** Many of the holding tanks are just buried in the ground. The freezing and thawing of the

ground can cause damage to the tanks, so that many of them are probably not longer watertight. Besides, waste containers may be lifted in the ground with raising groundwater levels during heavy rains; this damages the containers and creates leaks.

Though the current practice effectively prevents the pollution of the lake in situ, it is no solution to dealing with wastewater issues. The problem is essentially just transferred to another place. Besides, the discharge of significant quantities of wastewater in one locally limited area can lead to a deterioration of groundwater quality in the dump area.

## 7.2 Local People’s Current Sanitation Technologies

Though the Mongolian government officially only recognizes *lined* pit latrines as adequate (apart from sewer connected, septic, or pour flush systems), the people in Khatgal exclusively have conventional, unlined pit latrines with a wooden superstructure. A common pit for one family measures about 2x3x2 m; when a family of five uses it, it takes about ten years to fill (KHATGAL COMMUNITY MEETING 2007b). When the pit is full, it is covered with soil

and a new pit is dug, whereby the value of a property decreases with every additional pit that is dug (ARIUNBOLD 2007). Permafrost and high groundwater tables make it difficult in some



Photo: K. CONRADIN

**Photo 21: Tilted pit toilet**

If simple pit latrines are not reinforced properly, they often tilt to the side when the permafrost ground thaws or gets soft due to the high groundwater table.

locations to build a stable pit latrine; the pits often have to be reinforced with wooden boards. If they are not reinforced, many of them tilt to the side. Furthermore, pit latrines are very unpleasant in summer (smell), and in the wintertime, there intense cold leads to the build-up of excreta-stalagmites that have to be broken with hammers or axes – not such a pleasant job.

Most houses in Khatgal are located several hundred meters from the shoreline of the lake (Map 5, p.55), and even the outflow of the lake still has drinking water quality. The naturally occurring filtration of the leachate in the underlying soil and gravel *currently* seems to be sufficient for this small population number.

If there are showers, the greywater is normally infiltrated directly into the ground. Greywater within the house is usually disposed of somewhere within the compounds, or just poured into the pit latrine. The latter is questionable, as it significantly increases the infiltration rate for pit toilets.

### 7.3 Current Solid Waste Management

Though solid waste management is not the prime focus in this study, it is included here because wastewater and solid waste management are closely connected in the Khatgal area. This issue was very frequently mentioned in the local people's discussions and interviews; thus a short overview should be given here. Moreover, solid waste management is crucial for the prevention of lake pollution.

Solid waste management is a real problem in the Khuvsgul area. Currently, the responsibilities concerning solid waste management are not totally clear. Some years ago, a private donor sponsored a solid waste collection truck for the National Park, but according to the local people, this truck was not used for its actual purpose, but in road construction instead. Then, another solid waste project was initiated by the organisers of the Mongolia "Sunrise to Sunset Race", an annual marathon held on Lake Khuvsgul. In cooperation with the Khovsgol Travel Company, an Ulaanbaatar based tour operator, this project finances a waste truck (including the driver), hands out a garbage bag and information to all tourists who enter the National Park, and organises the solid waste collection for the lodges. Though this waste collection works very well for the lodges, it unfortunately does not function for the local people. It remains unclear whether the truck driver is just not collecting the wastes of the local people, or whether they are not paying their fees for the waste collection, or whether the local people are simply not informed about this project. The wastes from the campsites are not collected, as nobody feels responsible for those. Local people either burn their



After the wastes are collected, they are transported to a dump and just discharged there. While all liquid waste must be transported to Kharagana (Photo 22), there is a second waste disposal site for solid waste in Jankhai on the western shore of Lake Khuvsgul (see Photo 23). There is no separation of wastes in both dumps: glass, plastic, paper and biodegradable waste are all dumped in the same spot. Both disposal grounds are only insufficiently separated from the surrounding environment, and leachate can infiltrate unhindered into the groundwater. If it is windy, the wastes are blown around. This year, the central dump in Kharagana was, after all, fenced off, so that livestock cannot enter it any more, but the protection is still insufficient. There are rumours that livestock had previously fallen ill or died after having entered the dumping site and eaten waste.

The central dump in Kharagana is guarded during the day by a watchman. This watchman issues a receipt to every truck which is disposing of waste, and notes the kind and amount of the waste. This practice functions as a controlling mechanism to find out if lodges are bringing all their wastes to the dump: if the statistics for a lodge are very implausible at the end of the season, then this lodge is fined. In the second waste dump, there is no such regulation or control; everyone can just dispose wastes there.



Photos: K. CONRADIN

**Photo 22: Kharagana waste dump south of Khatgal**

Both wastewater and solid waste from the lodges are deposited in this dump 8 km south of Khatgal. The dump is only insufficiently protected with a fence made out of wooden poles and barbed wire. Water can infiltrate the ground unhindered.



**Photo 23: Solid waste disposal site in Jankhai**

Solid waste of lodges that are located further north of Khatgal in the Jankhai and Toilogt area is dumped in this small site in Jankhai. The site is not fenced off at all and is located only about 100 m from the lakeshore. Sawdust is used to cover the wastes and to make it look more appealing.

Though the central waste dump in Kharagana is situated quite far from the village and water sources, its location is not ideal, as it lies in an ancient riverbed. The disposal site in Jankhai is very unsuitable; it is a relatively deep hole that is located just about one hundred meters from the lakeshore. Leachate unavoidably seeps into the lake water.

Concluding, both the solid and the liquid waste management in the Khatgal are momentarily rather inefficiently organised and are, especially when considering that the area lies within a national park, in need of significant improvement.

## 8 ECOSAN IN KHATGAL

Though certain regulations and standardised procedures for managing solid and liquid waste exist, the current system does not satisfy all needs. Concerns are uttered by lodge owners, local people and tourists. For: apart from a general consciousness about the pristine ecosystem, it is not least the problems that result from current practices that shape the attitude towards new sanitation system considerably.

### 8.1 Lodge Owners and Ecosan



Photo: K. CONRADIN

**Photo 24: Ger camp at Lake Khuvsgul**

View of a ger camp on the western shore of Lake Khuvsgul. Most ger camps consist of a central administration building, a restaurant and a shower house; the “rooms” are traditional Mongolian gers.

The interest of lodge owners in new sanitation technologies was larger than had been expected previous to this study. This can probably mainly be put down to financial and maintenance reasons; but quite a few lodge owners also assert environmental motives. Nevertheless, the attitudes towards ecosan and their motivations varied largely.

The information for this chapter is based on interviews with roughly half of all lodge owners. All interviews are attached in Appendix 1.

#### 8.1.1 Awareness of Environmental Problems

Despite their rather bad reputation in the view of the local people, lodge owners are aware of environmental problems in the Lake Khuvsgul area. Many are also interested in alternative sanitation options to minimise the impact on the environment. In relation to sanitation, lodge owners are worried about the following aspects:

- Many deplore that “other” **lodges are built too close to the shoreline**; potential infiltration of leachate from toilets could lead to a pollution of the lake. It was additionally suggested that some lodges would not actually adhere to the current standards, that their tanks would leak or would not be emptied properly and that they would thus pose a threat to the environment. Lodge owners pointed out that liquid wastes might be discharged illegally somewhere in the forests. Some argued for stricter regulations that would not allow lodges to be built so close to the water.
- A few lodge owners pondered over the efficiency of the **central dump**: Essentially, they argue that the problem was just shifted, but not solved. For, “what is the difference between dumping the wastes untreated into the nature there or in some other place?” (NARANCHIMEG 2007) Those lodge owners who were concerned about the dump also suggested that solid wastes should be separated and, if possible, recycled, and that the

dump should be improved. It was stated that the dump's location was unsuitable, as it is placed in an ancient riverbed: during heavy rainfall, wastes could be washed away.

- A significant share of the lodge owners thought the **campers** were the main culprits. Tourists (especially the domestic ones) would not respect any regulations, and would not make use of the provided toilets and or take their garbage with them. They would wash themselves and their cars directly in the lake and would therefore pollute the water. Many called for **stricter regulations and better management** of the **campsites**. At the moment, these are perceived to be an almost extralegal sphere where tourists can do whatever they please, and for which nobody is responsible.

Furthermore, lodge owners showed their concern for the environment also by expressing the following worries.

- In the past 70 years, a lot of **trees were cut down** around the village. More recently the main logging activities have shifted to the places where most new lodges are built (Jankhai). There is a need to reforest these areas; especially the woods near the airport had an important function in protecting the village from the wind; today, it no longer exists. This wind now frequently brings a lot of dust into the village, as it passes over a dry riverbed.
- A better **solid waste management**, where the local people are included as well was considered crucial (see also 7.3). It was also demanded the local people have to adhere to certain rules in connection with solid waste.
- The **roads** along the shore of the lake are an important cause of soil erosion; they should be improved.

However, there was also a small number of lodge owners who are not at all aware of problems. They think that they **themselves fulfil the standards**, and that therefore, their impact on the environment was virtually eliminated. They exhibited an "out of sight, out of mind"-mentality that does not consider the wastes problematic any further than the point when they actually leave the tourist camp's grounds.

### 8.1.2 Problems with Current Sanitation Systems

The lodge owners' attitude towards new sanitation technologies is shaped by their perception of the current methods and the problems they cause:

- Most of the lodge owners complained that the current regulation was a significant **financial burden for them**, especially during low season (see also chapter 7.1.3). As Mrs. Selenge, a lodge manager from Ulaanbaatar states: "I think that the administration of Khatgal should decrease the price for the truck. Then it would work better for us.



Photo: K. CONRADIN

#### Photo 25: Logging in Jankhai

In Jankhai, an area on the south-western shore of Lake Khuvsgul where many lodges are built, a lot of logging takes place nowadays, be it for building ger camps or for firewood. Generally, logging is not allowed in the National Park, but special authorisations are issued by the local authorities.

Sometimes we do not have any guests and thus no profit, and then this truck is very expensive for us” (SELENGE 2007). Lodge owners currently lack the knowledge for alternative systems; flush toilets and holding tanks are regarded as the only available solution for tourist sanitation. Without the knowledge about alternative technologies, they are basically forced to build holding tanks and pay for their time- and resources-consuming maintenance.

- It was contended that the current regulations and the management make it difficult for the lodges to fulfil the standards all the time, because the **wastewater trucks may not always be available** when needed. The tenor of the lodges would appreciate systems that would make them less dependent on outside management.
- A further problem is that the current systems do not work all year round. Flush toilets **cannot be used in wintertime** as it is much too cold. Most lodges get their water from the lake, which is covered with ice several meters thick in the winter. The pipes of most lodges are not buried, the water would instantly freeze. Nevertheless, more and more lodges want to develop winter tourism in the area and need an adequate sanitation system.
- A further problem are **heavy rains** during the summertime; the road to Jankhai and Toilogt then becomes impassable. As this is the time when the utilisation of the lodges is highest, a delay of the emptying of a few days can easily lead to the fact that tanks overflow. Furthermore, rising groundwater tables during rainfall can cause damage to the holding tanks if they are not sufficiently anchored.



Photo: K. CONRADIN

**Photo 26: Outside plumbing**

The plumbing of most lodges is outside. On this photo, the water pipes on the house, the water tank behind it, and wastewater pipes in the front of the picture are visible.

### 8.1.3 Attitudes towards Ecosan: Advantages

As demonstrated, problems result for lodge owners from current sanitation practices. Accordingly, many lodge owners showed a considerable interest in alternative sanitation techniques. The following aspects shape the attitudes towards ecosan:

- **Economic aspects** (see also 7.1.3) are considered a crucial advantage over conventional systems. They were mentioned by most lodge owners: With ecosan systems, lodges could save significant sums on water and transport costs after a reasonable initial investment.

At the moment, most lodges build pit toilets for their staff in addition to the tourists' flush toilets. This is also for cost reasons, as the wastewater holding tanks would fill up much too quickly if all the staff would use them. With ecosan systems, this would not be necessary, both staff and tourists could use ecosan toilets.

- The second biggest advantage, which was mentioned by roughly half of the lodge owners, was **maintenance**. It was argued that ecosan would make lodges more

**independent from the communal wastewater management**, given that greywater treatment systems are implemented at the same time as ecosan toilets. The management of wastewater is obviously a very serious issue. Most likely, it is not always only the lodge managers who are to blame if wastewater is leaking into the ground near the lodges; much rather, it seems that they often have to wait for the wastewater truck. There are only two trucks: if they do not call early enough, or if the truck is busy or cannot reach the area (e.g. due to heavy rains), wastewater tanks can overflow. It was perceived to be a large benefit that the ecosan system could be managed more autonomously.

Most lodge owners contended that the ecosan toilet would be clean and hygienic to handle and that maintenance works could be carried out by their own staff. Containers could be changed independently whenever necessary. It is interesting to see that lodge owners perceived the maintenance of the ecosan toilet to be an advantage, while this was frequently mentioned as a disadvantage both by local people and tourists. This can probably be explained by the fact that lodge owners would not be the actual ones who carry out maintenance work. Much rather, they could delegate these tasks to their own staff instead of having to count on the unreliable communal services.

- Similarly, more than half of the lodge owners also stressed that it would be **easy to implement** simple dehydration toilets by themselves, that it is not a system that would need great engineering skills, and that most of the material necessary to build a UDD toilet (except the separation seat) would be locally available.
- Many lodges would like to implement systems that are **more environmentally friendly**. Ecosan systems could help to protect the lake from pollution because there is no infiltration of any dangerous liquids and it poses an alternative to the often-leaking tanks. However, this attitude may not only be based on the lodge owners' own environmental friendliness, but also because they understand that the pristine nature is the basis and resource for tourism; eco-tourism is a promising field which they would like to enter. A few lodge owners viewed the production of fertilizer as an environmental benefit. Though this was a relatively rarely uttered opinion, it reflects traditional Mongolian, Buddhism-inspired thinking that all material flows are circular.
- Budget guesthouse owners face similar problems as the local people do: they **can often not build conventional pit toilets** due to high groundwater tables or permafrost. They are thus interested in solutions for which these conditions would not pose obstacles. The same point is important for those lodges that still own a conventional pit toilet for their staff. Besides, ecosan offers a sustainable alternative to those budget lodge/guesthouse owners for which flush toilets with holding tanks are a far too big investment.
- Ecosan toilets are more **adapted to the local environment** and can be used in wintertime as well. Several lodge owners deplored that they could not use their flush toilets in the winter, and that tourists would then have to put up with the conventional Mongolian pit latrines. As the proposed ecosan toilets can be constructed entirely above

ground, they do not suffer damage from freezing ground, and are not in danger of inundation during heavy rainfalls.

- A few found advantages concerning the comfort of the toilet: because there are no bad smells in a properly managed UDD toilet, it offers a **high level of comfort** and can easily also be constructed for tourists.

An important point when considering attitudes towards ecosan is that most of the lodge owners are **waiting for legal standards** that would enable them to get away from the current flush toilets systems. A quote by Mr. Ganbaatar, a local guesthouse owner, exemplifies this:

All guesthouses and tourist camps are just waiting for a good new standard and good ideas for sanitation. The standard now [flush toilets] does not work here under this weather conditions and with the current infrastructure. The pipes freeze in the winter, and it needs a lot of water. Furthermore, we do not know where to put this water afterwards. So it will be a good idea to use this kind of [no-mix] toilets. It is good because we save water, and because we have less pollution ... it is good in any way! [laughs]. All tourist camps are waiting for the one good standard practice of dealing with wastewater. If we use this toilet, we can prevent many problems: we do not have to be afraid of faeces, we do not have to be afraid of smells or of pollution, and we do not have to be scared of the inspectors! (GANBAATAR 2007)

It is very important to consider that though many lodge owners were quite positive towards ecosan as such – mainly for economic, environmental and maintenance reasons – ecosan will only be applied on a wider scale if it is accepted as a sanitation standard by the hygiene and environmental inspectors. Only then is it actually a legal solution and lodge owners will not come into conflict with the law for not adhering to standards.

#### 8.1.4 Attitudes towards Ecosan: Disadvantages

- Just as roughly half of the lodge owners deemed the easy maintenance and larger autonomy an advantage, the other half contended that the **maintenance of ecosan toilets was more labour intensive**, and hence a disadvantage. Some of these answers can be put down to the design of the current pilot project toilet. As it is located in a relatively small ger camp, 20 L containers were used for urine collection; these had to be emptied quite often. Owners of larger lodges were afraid that they would have to empty their tanks daily. Others deplored that while now, the main labour would be done by the truck driver who pumps out the wastewater holding tanks, they would have to invest own human resources in the maintenance of the toilet. Some bemoaned the manual handling of human excreta (though merely urine is handled, faeces are only removed from the toilet when they are dry and exhibit a soil-like texture).
- Several lodge owners were concerned about the **limited size** of the demonstration toilet. They thought it would not be suitable for larger lodges and that it could only be implemented for small guesthouses. For larger lodges, there would be too much maintenance work, and too large volumes. In order to convince these lodge owners, it would be necessary to have a somewhat larger demonstration object that shows that ecosan can be very well adapted in scale and can be a solution both for small guesthouses and large ger camps.

- Another concern that was frequently uttered was that the whole change to UDD toilet would not be beneficial if there was not, at the same time, a **system to treat greywater** on site. Without this, there would be no point for the lodges to install ecosan toilets, as they would still have to rely on the wastewater truck. They felt that by merely constructing dry toilets, their volume of wastewater would not be significantly decreased. This argument is certainly true, although already the implementation of non-flush toilets would probably result in significant water savings, (as wastewater in this area is mainly composed of two parts: wastewater from showers and from toilets).
- Quite a few lodge owners expressed their concern about the **safety of this new ecosan toilet**. Some thought that these systems came from southern countries and might not be adapted to the harsh climate of Mongolia. They were afraid that the hygienisation would not work as explained, and that the end product would still contain pathogens that could be harmful when reused. Hence, it was argued that the sanitisation of the human excreta should not be left to the individual lodge owners, but should be carried out professionally in order to create a hygienically flawless end product.
- A small number thought that the ecosan toilet might not offer as much **user comfort** to the tourists as flush toilets do. They were afraid that such a simple toilet would make them look backwards in the tourist business. They were worried that the toilet would smell just like a pit latrine, something they do not wish to offend their clients with. It would be motivating to confront these lodge owners with the results from the tourists' survey which clearly shows that most of them would be happy to see more environmentally friendly toilets, and that they did not perceive them to be less comfortable than flush toilets. In addition, it would be necessary to demonstrate that ecosan is not only a low-tech approach, but can include an array of technologies of various levels of sophistication.
- Despite all this criticism, roughly a **third of all lodge owners could not see any disadvantage** in the new ecosan toilet; one person even summed up the whole discussion with the statement that "there is nothing bad about this toilet. It has many advantages, and it is even profitable!" (SELENGE 2007) However, a point raised was also that these toilets would only be beneficial to the environment if everybody participates: In order to change the situation fundamentally, a concerted effort would be needed.

### **8.1.5 Organisation and Maintenance of Ecosan Toilets**

Concerning the organisation of future ecosan systems, there were two opposing opinions:

- About half of all owners argue for a **centralised management** of ecosan toilets. They put forward that it would make the whole system more professional and that it would eliminate the risk of mismanagement and potential pollution. They also think that during tourism season, they would not have time to take care of the ecosan toilet properly; and they argue that they would have neither the room nor the resources to properly reuse the ecosan fertilizer. An argument in support of this attitude is that there is no urgent need for fertilizer in the Khatgal area; thus, there would be a certain high risk that lodges just dump the (maybe only partly hygienised) contents of the collection chambers

somewhere in the forest whenever they are full. A centralised servicing would guarantee the professional management of excreta.

- The other half contended that a **private management** would make more sense. They argued that it would not be feasible to establish a service provision authority that would be responsible for the management of the toilets in the Khatgal area. Some of this group actually *also* favoured a central management authority, e.g. an NGO, but just considered this solution unrealistic. However, some others thought that it would simply be better if everybody would be responsible for the full management of the toilets themselves: only this solution would give them more autonomy and make them less dependent from service providers who were, in their present experience, rather unreliable. It would also help them to keep the costs as low as possible. A few would like to make use of the fertilizer themselves, as they regard it as beneficial.

### 8.1.6 Preconditions and Support

In order that lodges implement ecosan systems, some precondition have to be fulfilled:

- The most frequently mentioned requirement was the acceptance of ecosan by the hygiene and environmental inspectors and the **existence of an officially approved legal standard** for ecosan toilets. Understandably, the lodges are not ready to switch to a new system – even if they see a number of benefits – if this would bring them into conflict with the law. Given that there is a standard that makes the construction of ecosan toilets an eligible solution, many lodges would readily change to ecosan. Most likely, more local research will have to be carried out to get such an official approval; however, this could be achieved by other organisations (such as for instance the GTZ) which are already working in this field and enjoy a good reputation.
- Another necessary precondition is that the lodges would like to get **more factual information** on the ecosan toilets: they would like to know more about the actual mode of operation, hygiene and safety aspects, more adapted designs, and construction plans or cross sections for ecosan in Mongolia.
- A very practical and necessary precondition to build ecosan toilets is, of course, the local availability of **urine-separating toilet seats** at an affordable price. Currently, there is one manufacturer of fibreglass-moulded separation seats in Ulaanbaatar; but these are quite expensive. Nevertheless, other producers might enter this field and produce other models at lower costs, especially if other GOs and NGOs keep on promoting alternative, urine separating sanitation solutions.
- It was mentioned that given there is central service provider for the collection, hygienisation and reuse of the fertilizer, this person/organisation should have an **economic gain** from these tasks, apart from the payment received for the pick-up of the excreta. This would not only make sure that the reuse of the ecosan fertilizer is processed in a professional manner, but it would also make the system more reliable than the communal system.

Most lodge owners thought that the main support they needed for actually implementing ecosan toilets would be more in-depth information. The construction of the toilet as such was



regarded as relatively easy, but the lodge owners would like to learn more about the whole ecosan concept, safety and hygiene aspects or operation and maintenance approaches in order to prevent that more pollution results from the new toilet than from the current wastewater management systems. Some, especially the owners of low-budget guesthouses, thought that some financial support was necessary for them to implement such toilets.

### 8.1.7 Acceptance of Reuse Concepts

Lodge owners were asked to state their opinion on various reuse options. The following potential options were considered suitable:

- The **planting of trees** enjoyed the largest acceptance. Trees are a good option mainly because they will not be eaten afterwards. Many lodge owners are quite sceptical to reuse sanitised human excreta on food products, and believe that the acceptance of food crops that have been fertilized with ecosan fertilizer will be very low. Furthermore, trees are often used as scenic elements on the lodges' compounds. With ecosan, it would be easy to use the fertilizer right on site. Still, some argue that it would be OK to reuse the fertilizer for trees, but that this should be done well away from human settlements in order to prevent the spreading of diseases if the fertilizer was maybe not totally hygienic. Trees were considered an adequate solution also because agriculture and horticulture are difficult to practise locally due to the short vegetation period and high number of days with frost.
- **Berries, sea buckthorn or fruit trees** were mostly considered acceptable as well, as they grow above the ground and are not in direct contact with the ecosan fertilizer. Sea buckthorn is a local fruit bush that can tolerate extreme cold and does not have high water requirements (THOMAS & MCLOUGHLIN 1997: 11). It is grown commercially in various areas in Mongolia, and the worldwide demand is increasing due to the high vitamin and mineral contents of the fruit and the high quality oil gained from the seeds.
- Interestingly, there were also quite few lodge owners thought it would be a good option to reuse the fertilizer for **gardens and vegetable production**. They argued that even now, a large part of the vegetables available in Mongolia were imported from China and were fertilized with human excreta anyways; so it would be better to reuse their own and properly sanitized excreta as a fertilizer. Others thought that this kind of fertilizer was better than chemical one, or that it would not be so different from using animal dung. A reason why the reuse for food crops enjoys a higher recognition among lodge owners might be that they now have to buy expensive vegetables from Muren or even Ulaanbaatar to satisfy the tastes of tourists. Vegetables are often imported by plane and in consequence quite expensive. Planting vegetables in own greenhouses and increasing the harvest by using own fertilizer could make it easier for lodge owners to get seasonal, high quality and fresh vegetables at a reasonable cost.
- A fourth group of lodge owners would consider it the best solution if the sanitised human excreta would just be brought to the **central waste dump, or buried** somewhere in the forest. In their opinion, this would still improve the environmental situation on site, as, in contrast to the current system, only inoffensive end products would be disposed of in nature. Moreover, the plants that are growing where the excreta are disposed would still

benefit from the fertilizer effect. In consequence, the nutrient cycle would be closed. They mostly regard it as too time consuming to reuse the ecosan fertilizer, saw no need for it, or thought there would be no benefits from the reuse.

## **8.2 Tourists and Ecosan**

In order to investigate tourists' perceptions of the current situation and their attitude towards ecosan systems, more than one hundred mainly foreign tourists were interviewed with a standardised questionnaire in summer 2007. Tourists uniformly greeted the introduction of more environmentally friendly and sustainable sanitation technologies in Khatgal. They were aware of the influences tourism has on the environment of the Lake Khuvsgul area, and supported measures that limit the negative impacts of tourism on the environment.

### **8.2.1 Demographic Aspects**

A total of 104 tourists participated in the survey during the months of June, July and August 2007. Both men and women were equally represented, with 48.1% males and 51.9% females. Most of the participants (46.1%) were between 20 and 29 years old, and 21.6% were between 30 and 39 years old. There were few participants below 20 years of age, and only a total of 17.7% that were over 50 years old. This distribution is in part due to the fact that many people who were staying in the budget accommodation M.S. Guesthouse next door to Khuvsgul Inn. This kind of guesthouse naturally attracts a younger clientele. Persons from a total of 20 nations, including Mongolia, were interviewed. About one quarter came from either the USA or Canada, two thirds (65%) from various European countries, and 8.7% from Asia (mainly Japan and Korea). For an overview of the survey procedure, see 4.4.1.

### **8.2.2 Survey Biases**

#### ***Mongolia Attracts Environmentally Conscious Tourists***

Mongolia as a tourist destination and especially such a remote place as Khatgal attracts rather uncomplicated persons who all share a passion for nature<sup>25</sup>. This definitely influences the outcome of the acceptance study, as the interviewees were probably more concerned about nature and environment than a public at another tourist destination. Furthermore, most tourists who travel to Mongolia are well aware that there will be some curtailments in comfort, and therefore might have lower requirements than an average tourist elsewhere in the world. Though this is certainly a bias, it does not matter much in the context of this study, as these biases are likely to be the same in most rural tourist places in Mongolia.

#### ***Inclusion of Participants from M.S. Guesthouse***

At first, only tourists staying at the Khuvsgul Inn were interviewed. However, as there were not sufficient tourists there, also tourists from the neighbouring lodge (Munkh Saridag Guesthouse, M.S. Guesthouse for short) were asked to participate in the study. This may have influenced the following points:

---

<sup>25</sup> Lake Khuvsgul is the gem of the Khuvsgul National Park. Also called the "Blue Pearl", it offers endless larch forests alternating with meadows bursting with alpine flowers in the summer, rolling hills and snow-covered peaks, but no other tourist attractions in a more "cultural" sense.

- While Khuvsgul Inn is a rather upmarket ger camp, M.S. Guesthouse is *the* budget destination in town, attracting globetrotters with limited spending power from all around the world. The inclusion of tourists from this guesthouse probably lowered the amount tourists specified they would be willing to pay more for staying in a lodge with an environmentally friendly toilet system.
- Younger travellers generally put up with less comfortable conditions than older, more affluent ones; they may thus have lower expectations on a toilet, and the outcome of the question on the design of the toilet may have been positively influenced.

### ***Lower Expectations in Remote Place***

Though the tourists were asked to compare the ecosan UDD toilet to a regular flush toilet to judge the design, hygiene, smell and user comfort, they were obviously influenced by the experiences they have had before. Many of them were saying that this toilet was way better than anything they had used so far in Mongolia; so it is likely that some of them were biased by the rather unpleasant experience of using a simple pit latrine. The results for this questions were probably also affected by the remote setting, where people naturally do not expect as much comfort as in an urban upper-class hotel.

### ***Trial Garden***

The trial garden may have biased the outcome of the question on advantages. As the effects of the fertilizer were visualised in situ, tourists may have been influenced to consider fertilizer as very advantageous; they may not have mentioned this so frequently in the absence of the garden.

## **8.2.3 Awareness of Environmental Problems**

### ***Sanitation Problems around Lake Khuvsgul***

Roughly 40% of the tourists were aware of problems in relation to sanitation around Lake Khuvsgul or could imagine what kind of problems there could be (Q1, n=103, 1 missing). This relatively low number is not surprising as the lake itself is still very clean. The official wastewater management practice – the discharge of untreated wastewater from lodges into a centralised dump – is not visible for tourists. The population of Khatgal is relatively small and the lake is huge; so most people assume that the environment can assimilate the generated wastes. This holds true for the moment, but an increase in the number of tourists and tourist facilities built directly on the shoreline poses risks for the future. Research by OYUNMUNKH (2008) this summer has shown that first impacts of human activities are measurable in the waters at the western shore of Lake Khuvsgul.

Those people who were aware of sanitation problems (n=41)<sup>26</sup> mainly regarded the potential infiltration of pathogens into the soil and groundwater or the pollution of the environment through excreta as a problem (together 46.7%) (Q1.1, open question, multiple answers possible). Other issues that were considered critical include the potential pollution of drinking water (17.6%), or the discharge of untreated wastewater into the environment (13.3%). A few (5.6%) were thinking about the impact of a growing tourism industry.

<sup>26</sup> If not otherwise stated, no answers were missing. Figures that are significantly lower than 104 represent sub-samples, i.e., answers such as comments or specifications, or answers of the type: "If yes, please specify..."

**Current Wastewater Management Practices**

When explained about the current practice of wastewater management for the lodges, i.e., that collected wastewater is discharged untreated into a central dump, almost 70% of the tourists expressed their concern or open disdain about these practices (Q2, n=101). The following points of concern were raised most frequently (Q2.1, n=70, open question, multiple answers possible):

- The interviewees were afraid that the practice will lead to pollution of the lake, the ground, or that it could potentially infiltrate and threaten groundwater reserves or people further downstream (31.7%).
- About 13% were concerned that the practice is highly unhygienic, as untreated sewage is disposed openly into the environment (13.4%).
- Some deplored that this is no solution for wastewater management, as the problem is just shifted somewhere else, and stated that there must be better solutions for it (11%).
- Yet, many were of the opinion that though the practice is everything else than ideal, it was still better than letting the lodges discharge their wastewater directly into the lake, or closer to the village (13.4%).

It was also recognized that the problem will aggravate if the influx of tourists increases in the future. Others stated that the practice is unsustainable, highly inefficient (long transport distances) and short-sighted, and regretted that the people in charge lacked the knowledge of dealing with wastewater management in a more sustainable way. The point was raised that tourists pay entrance fee for the National Park, and they expect the authorities to use this money to deal more efficiently and sustainably with such issues.

**8.2.4 Importance of Environmentally Friendly Sanitation Technologies**

**Q3: How important is it to you that the lodge you are staying at uses environmentally friendly sanitation technologies?**

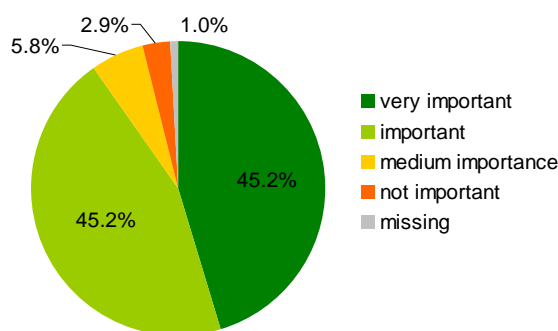

n=104, 1 missing  
Source: Own Survey, June-August 2007

**Fig. 15: Importance of environmentally friendly technologies**

For more than 90% of the interviewed tourists, it is either very important or important that the place where they are staying uses environmentally friendly sanitation technologies.

Environmentally friendly sanitation technologies are attributed great importance by the tourists visiting the Lake Khuvsgul area. They seem to be aware of the fragility of the local ecosystem. But more importantly, they recognize that they have a certain influence on the tourist industry, as many people stated to investigate this aspect before embarking on a journey.

For nine out of ten tourists, it is either very important or important that the place where they are staying uses environmentally friendly sanitation technologies (Fig. 15, Q3, n=104). Of

course, there is a difference between considering this aspect theoretically important and actually choosing a place according to whether a good technology is used.

However, tourists did not simply make this statement so that they would look good; (Q4, n=104) most of them stated (80.2%) that they are also willing to accept the consequences of their decision and pay more to stay at a place that offers environmentally friendly technology, with no noteworthy difference between men and women.

Although there is certainly a difference between saying this and actually paying more, this could be an important argument for lodge owners, as they would be able to cover the extra costs of more environmentally friendly technologies with a small increase in their rates. Apart from real budget travellers, a small price rise of a few dollars per night would most likely not prevent tourists from choosing a certain lodge if the services provided justify this increase.

**Q 4.1 How much more would you be willing to pay per night for staying in a lodge that uses environmentally friendly sanitation technology?**

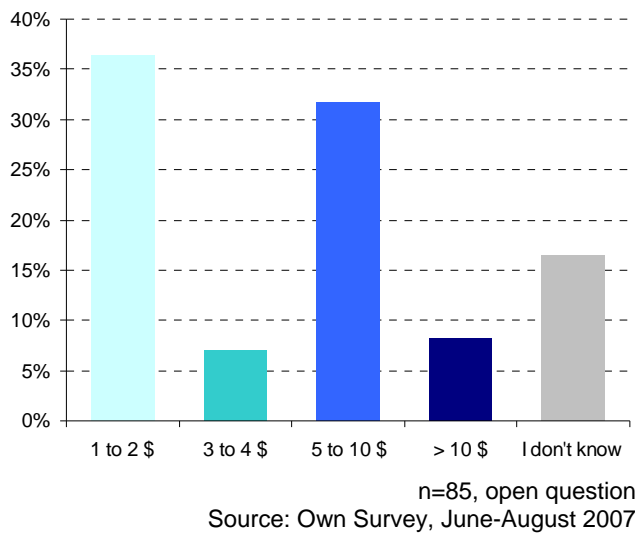

**Fig. 16: Willingness to pay more for a lodge with environmentally friendly technology**

More than 80% of the interviewed tourists said that they were willing to pay more for staying in a lodge with environmentally friendly sanitation technology. The graph above shows how much more they indicated they would be willing to pay. A night in a budget accommodation cost about 5\$, in a “top end” location, it can cost up to 30\$.

foreign tourists. This puts the tourists’ utterances into perspective: Though not all of them would probably really chose the more expensive but environmentally friendly lodge if they actually had a choice, a small increase in price would probably only deter a part of real low budget travellers (of which there are not yet so many in Mongolia), while most others would probably not bother about amounts of a few dollars (especially when considering that tourists generally do not stay longer than a few nights in this area). As mentioned in chapter 8.2.2, there is a bias in that sense that many of the interviewed tourists were young budget travellers. However, if already these travellers are stating that they would be willing to pay 20 to 40% more, it can be assumed that regular travellers could also afford this amount.

Some tourists argued that environmentally friendly technology must not necessarily be more expensive. This is certainly true; nevertheless, it would be an investment for most lodges to

Figure Fig. 16 shows the additional costs tourists would be willing to cover. Of all those who said they would be willing to pay more (Q4.1, n=85, open question), 36% were willing to pay 1 to 2\$ per night, 7% would give 3 to 4\$ more, 32% could defray 5 to 10\$, and 8% were willing to add more than 10\$ to the current price. At first sight, the amounts tourist indicated seem to be small. However, one has to consider that the price level in the countryside in Mongolia is relatively low. A night in a budget accommodation, including breakfast, cost around 5\$ in summer 2007. The price for the most expensive lodges around the lake was about 30\$ per night. Looking at it like this, a few dollars pose a significant amount of the current price, but still make accommodation very affordable for

switch to a new system. The results of this survey show that these costs need not be covered entirely by the lodges themselves, but that tourists are willing to pay their share in order to make tourism more sustainable.

### 8.2.5 New Ecosan Urine-Diversion Toilet at Khuvsgul Inn

All of the interviewees were shown the toilet before the interview. At first, only tourists staying at Khuvsgul Inn, who had a chance to actually use the toilet were questioned (though there was also a regular VIP toilet that tourists could use). However, as there were not enough tourists to interview in Khuvsgul Inn, the tourists from the neighbouring M.S. Guesthouse were also asked to participate in the survey. Those tourists naturally did not always have to use the toilet when they were shown it (Q5.1, n=104)<sup>27</sup>. In total, roughly half of the people actually used the toilet (44%). Only those answers were considered in the analysis.

Generally, most people judged the new no-mix toilet positively (Q6, n=45). Four fifths found the design of the toilet to be better than (37.8%) or about the same (42.2%) as that of a regular flush toilet. This might be influenced by the fact that they did not only judge the design from an aesthetic point of view, but also considered the purpose of separating. Women generally rather thought the design to be about the same as that of a conventional flush toilet, while men found it more often better. Still 27.6% of the participants thought the no-mix toilet scored better in hygienic aspects, and 53.3% found it to be about the same as a regular flush toilet. However, men generally found the hygiene of this toilet better than a regular one (55%), while only 8% of the women thought so (they mostly considered it the same).

**Q6: How do you find the no-mix toilet in comparison to a regular (flush) toilet?**

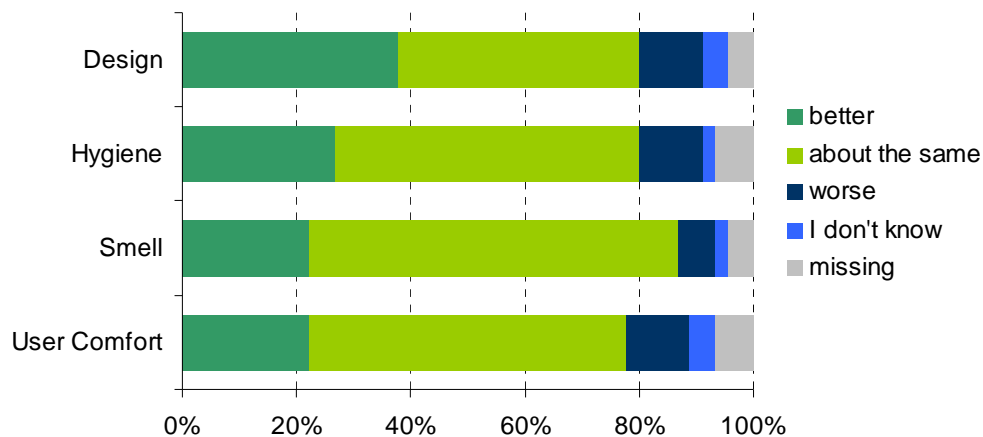

n=45, 1 missing in row 1 and 3, 3 missing in row 2 and 4  
Source: Own Survey, June - August 2007

**Fig. 17: Tourists' rating of the design, hygiene, smell and user comfort of the new ecosan UDD toilet**

In general, more than half of the interviewees found the design, smell, hygiene and user comfort of the ecosan UDD toilet to be better or about the same as a regular (flush) toilet. Only very small percentages of all users found it worse.

<sup>27</sup> This question has been adapted from question six of the questionnaire on no-mix toilets used by J. Lienert and T. Larsen to determine the acceptance of no-mix toilets. Their questionnaire was developed in 2006 by the Interfakultäre Koordinationsstelle für Allgemeine Ökologie (IKAÖ) of the University of Berne, and the Swiss Federal Institute of Aquatic Science and Technology EAWAG.

Interestingly, almost a quarter (22.2%) of the participants thought the urine-diversion toilet smelled better than a regular toilet, and a noticeable 64.4% thought it smelled just the same as a regular toilet. These figures are a very good illustration to combat the prejudice that waterless toilets offer less user comfort. This is most likely due to the fact that the toilet was very well ventilated. Air coming in through louvers in the door was sucked down the toilet by thermal processes and then went outside through a chimney. Like this, there was always plenty of fresh air in the toilet cubicle.

Nearly four fifths (77.8%) thought that the toilet offered a better or similar general user comfort in comparison to a regular toilet. In fact, after people use a separating toilet for the first time and notice that is not altogether different from using a regular toilet, biases in what concerns the comfort of this toilet are usually smoothed out.

All in all, more interviewees found this basic UDD toilet to be better than or comparable to a regular flush toilet. These are indeed promising figures that could help to convince those lodge owners that were worried that their clients would have to put up with less comfort.

### **8.2.6 Ecosan Concept**

#### ***Rating of the Ecosan Concept***

Only about a third of the survey participants (29.8%) knew about the concept behind urine-separating toilets before they were told so during their interview (Q7, n=104). In that sense, interviewing involved a lot of explaining and awareness raising for ecosan. Most of those who did know about the concept (Q7.1, n=30, open question, multiple answers possible) had seen one of these toilets somewhere else or had read or heard of this concept from other sources. They knew that human excreta can also be used as a fertilizer. Many of those who answered the question in the affirmative had been to China, where the practice of using human excreta in agriculture is widespread.

Almost all of the interviewees thought it was a good concept (97.1%, Q8, n=104).

#### ***Ecosan in Lake Khuvsgul National Park***

Most people responded in the affirmative to the question what they thought of the idea of introducing ecosan toilets to this area. Of all interviewees, 96.2% greeted this option (Q9, n=104). Nobody thought it was a bad idea to introduce ecosan toilets, but 3.8% were insecure.

The reasons why tourists perceived it as a good idea to introduce ecosan to the Khuvsgul area (Q9.1, n=74, open question, multiple answers possible) were similar to those presented in the previous question, however, with a different distribution.

Protecting the pristine nature in the National Park and preventing pollution (45.9%) were the main argument for introducing ecosan to the area. One quarter (27%) specifically mentioned the lake, not only the main attraction of the area, but also the only source of water. In particular, tourists stressed the risk of pollution of groundwater and subsequent infiltration into the lake. Roughly one tenth appreciated the augmented cleanliness, hygiene and comfort that come along with the implementation of new toilets. Other arguments for ecosan toilets in Khuvsgul are awareness raising: many tourists come to the area each year, so that many people would learn about this new concept. Others mentioned the fact that the

problems and pollution will increase with higher tourist numbers if no adequate and sustainable solutions are found now.

**Q 9.1 Please specify why you think it is good/bad to introduce ecosan to the Lake Khuvsgul area?**

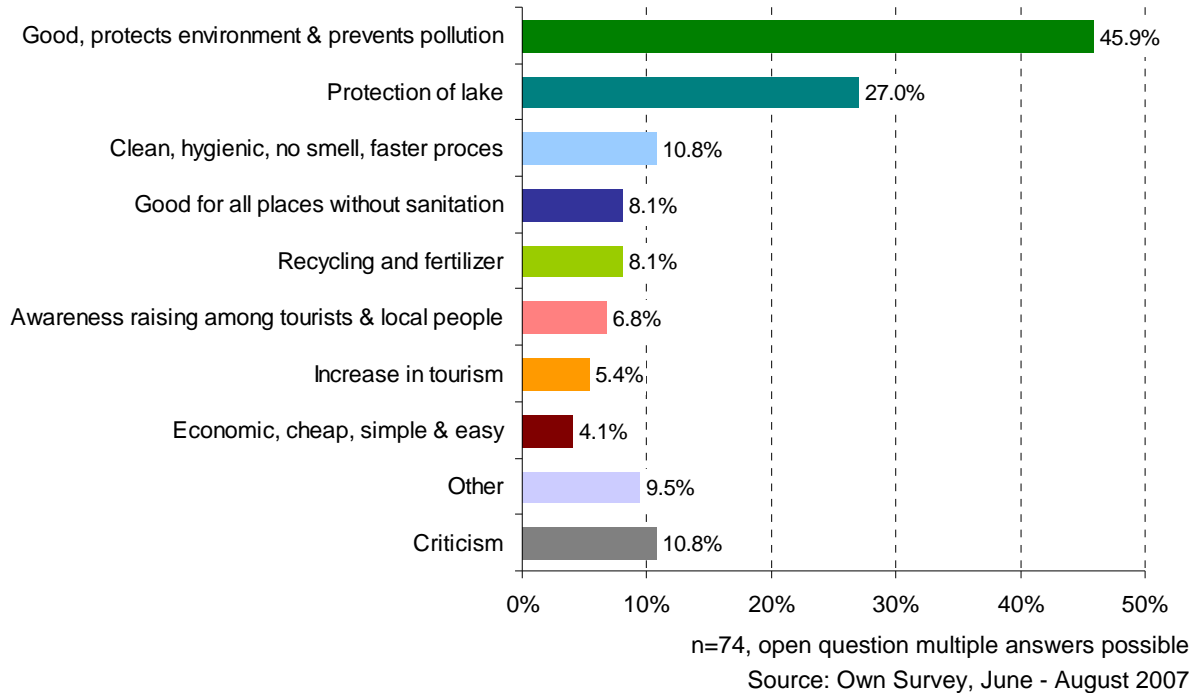

**Fig. 18: Reasons for introducing ecosan to the Khuvsgul area, tourists' evaluation**

Most people found it a good idea to introduce ecosan to the Lake Khuvsgul area (96.2%, n=104). Of those who specified their answer, the argument that was most often brought forward was that it helps to protect the local environment and prevents pollution. Other reasons included hygienic aspects, awareness raising and the need for adequate sanitation solutions, especially with increasing tourist numbers.

Those who had some more critical inputs wondered about the sustainability of this project, e.g., whether it would continue to be maintained properly without supervision. Furthermore, it was acknowledged that it is not that easy to get a completely hygienic end product, and that there is a need for much more education and awareness raising among the local population and lodge owners.

## 8.2.7 Advantages and Disadvantages of the Ecosan Toilet in Khuvsgul Inn

### *Advantages of the Ecosan UDD Toilet*

In question ten (Q10, n=103, open question, multiple answers possible), tourists were asked to indicate the biggest advantages of ecosan in their own view. The question was formulated openly so that the tourists would not be influenced by predefined answers. The answers covered a wide spectrum of benefits (Fig. 19)

Tourists thought the biggest advantage when talking about ecosan was the production of fertilizer and the closing of material flow cycles (49.5% of all tourists). Before seeing this toilet, most of the tourists had never heard of ecological sanitation, and had probably never heard that excreta can be something else than waste. Thus, many of them were very impressed by the fact that human excreta can actually be reused, and that it can improve soil fertility.

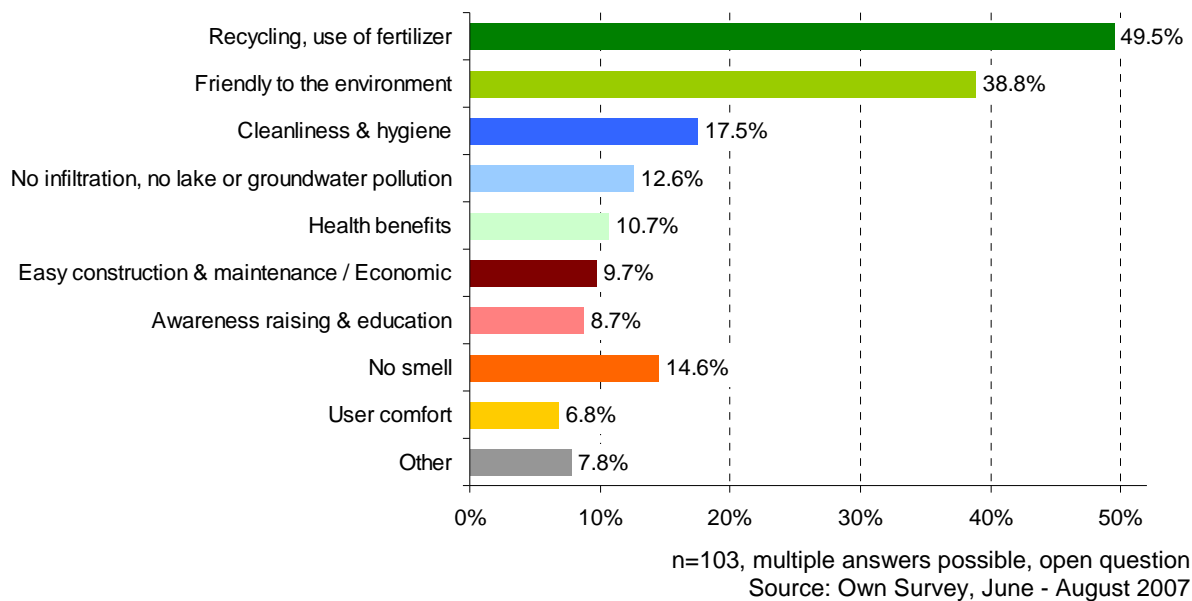

**Q10: In your view, what are the biggest advantages of the ecosan toilet in Khuvsgul Inn?****Fig. 19: Biggest advantages of ecosan, tourists' evaluation**

When asked to name the biggest advantages of ecosan in their own view, the interviewed tourists came up with a wide range of answers. For most, the reuse of the nutrients (in general) and the closing of material cycles was the biggest advantage, followed by environmental benefits. Other aspects were mentioned fewer, but nevertheless included important points such as hygienic improvement, health benefits, maintenance aspects and awareness raising.

Another aspect that was held high was the toilet's environmental friendliness. This is of course regarded as important because the pristine nature is the main attraction in the Lake Khuvsgul area and must be protected. But also health and hygiene aspects, such as cleanliness (17.5%), the absence of groundwater infiltration and lake pollution (12.6%) or health benefits (10.7%) were considered important advantages. Others mentioned the easy construction and economic attractiveness for lodge owners (see chapter 8.1.3). Awareness raising and education are considered advantageous, as a number of tourists could be educated. If ecosan toilets would be placed strategically in public buildings, also the local population could benefit and learn about this new concept. A last group of advantages is rather personal, i.e., the increased comfort (6.8%) an ecosan urine-diversion toilet offers over a conventional pit toilet, specifically through a lack of smell (14.6%).

***Disadvantages of the Ecosan UDD Toilet***

Though most tourists were very enthusiastic about the ecosan UDD toilet, they also identified some disadvantages, as Fig. 20 shows (Q11, n=103 open question, multiple answers possible):

The disadvantage that was named most was the suspected higher cost of the ecosan toilet (35.1%), which they perceived to be a burden for local people and a deterrent for lodge owners. Another drawback that was frequently mentioned (24.74%) was the surplus in maintenance work that was required to keep the toilet functioning. This is most likely also due to the specific design of the UDD toilet built in Khuvsgul Inn (see chapter 6), where small urine containers made a frequent emptying necessary.

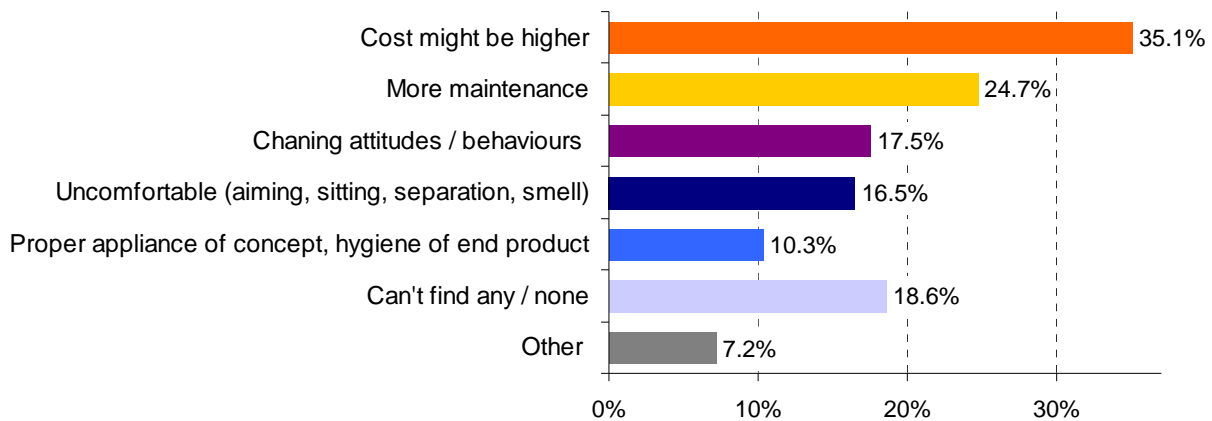
**Q 11: In your view, what are the biggest disadvantages of the ecosan toilet in Khuvsgul Inn?**

n=103, multiple answers possible, open question

Source: Own Survey, June - August 2007

**Fig. 20: Biggest disadvantages of ecosan, tourists' evaluation**

Tourists view the additional maintenance work that is required for a UDD toilet as the biggest disadvantage. Other disadvantages are the potentially higher cost (especially for local inhabitants), changing attitudes, a different "toilet behaviour" and the proper appliance of the concept without supervision.

Other disadvantages that were less often mentioned included the fact that this system requires a change in attitude and behaviour (17.5%), and that it is difficult to make sure that the concept is applied properly and a hygienic end product is produced (10.3%); they thought that proper education was necessary. Some interviewees deplored a decline in comfort (16.5%). Some of them were unhappy about the stairs to the toilet. Some did not like the fact that they had to sit down on a public toilet, an issue that is always debated, especially among women. Others found it difficult to aim so that the separation was complete.

However, though some drawbacks were identified, there were quite a significant number of people who said they could not think of any disadvantages, that they did not know, or that they simply thought there were none (18.6%).

### 8.2.8 Acceptance of Reuse Concepts

Most of the tourists were amazingly open concerning reuse concept (Q12, n=104) and had a very high tolerance towards nutrient reuse for food products. This may be caused by the fact that many travellers had been to China already, where the practice of using excreta to fertilize vegetables is very common (but treatment is not always adequate).

Nearly all tourists (98%) accepted wood as a reuse option, while 85.3% thought meat and milk from animals that had eaten forage fertilized with human excreta was fine. Also agricultural produce such as cereals, i.e., products that are normally eaten in a highly processed form, enjoyed a high acceptance (81.4%). Interestingly, most interviewees did not even have concerns about vegetables: still more than two thirds (68.8%) indicated that they would eat vegetables that have been fertilized with human excreta. Berries and fruits, generally foods that grow above the ground, again enjoyed a higher acceptance, with more than 85% willing to eat berries and fruits fertilized with human excreta. Generally, this question proved to be one where almost everybody had a very opinionated point of view: Only two persons did not answer this question at all, one did not know what do respond, and one totally rejected the concept of using human excreta as a fertilizer. The results of this

study correspond well to the outcomes of an acceptance study carried out in Switzerland in 2000/2001 (PAHL-WOSTL ET AL. 2003: 62), where the majority (72%) was willing to buy food fertilized with human urine. In the same study, 80% stated that they would prefer vegetable fertilized with urine to artificial fertilizer.

**Q 12: Would you use/eat the following products that have been fertilized with sanitised human excreta?**

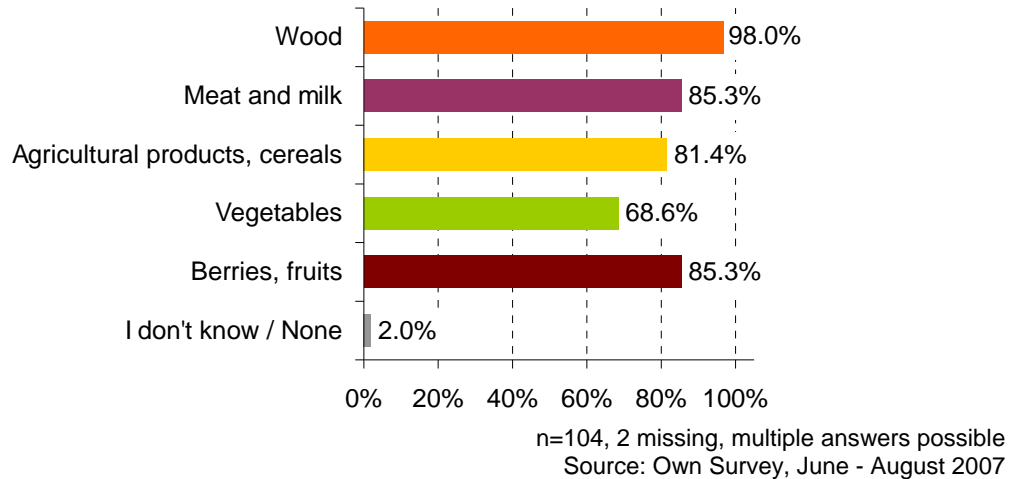

**Fig. 21: Accepted products fertilized with sanitised human excreta, tourists' evaluation**

Most tourists were very open when it came to the reuse of the treated humane excreta and had high tolerance levels. Wood, berries/fruits or meat and milk from animals that ate fodder fertilized with treated human excreta were most widely accepted. However, also agricultural products such as cereals and even vegetables would be eaten by more than three quarters of all tourists.

Among the reasons why people would eat or use one of the abovementioned products (Q12.1 n=73, open question, multiple answers possible) fertilized with human excreta, the naturalness of the product was the biggest motivator to approve of the reuse. One fifth (20.5%) found that human excreta are just about the same as animal dung, which has a long-standing tradition as fertilizer in agriculture; another 16.4% thought it was better to use human excreta than to use chemical fertilizer. However, roughly a quarter (28.8%) state that they would find additional tests necessary or would have to have more proves that it is safe in order to eat vegetables with an easy conscience. One tenth (9.6%) of the interviewees said that they would only consider eating food products fertilized with human excreta if they heard more expert opinions on it and would have informed themselves very well about the topic. The same fraction said that they would only eat products that were not in direct contact with the soil. Another tenth (12.3%) simply responded the question why they would eat or not eat specific products with the answer that there was no reason against doing so, and that they did not see any problems at all with this practice.

### 8.2.9 Legal Framework for Ecosan

Most of the tourist support legal actions for making tourism more sustainable (Q13, n=104): 85.6% of the respondents stated that they would support a law that made ecosan tourists mandatory for tourist infrastructures within Mongolian National Parks, or that ecosan would at least become a legal option for tourist lodges to chose from (see 7.1.1). The main argument for supporting legal actions (Q13.1, n=91, open question, multiple answers possible, was the imperative to preserve this pristine area, and the fact that tourist operators make use of the resource "nature" and should thus also be willing to preserve it. However, though most people supported legal action, they were also very much aware of the fact that decisions

Only 2.9% did not find legal actions to promote ecosan a good idea, and another 11.5% did not know; those mostly thought that imposing decisions will not lead to achieving the goals, but that the efforts should much rather come from the lodge owners themselves.

The results of this question must be interpreted as a clear sign that foreign tourists visiting Mongolia wish for a stricter and more environmentally friendly management of the natural resources according to the polluter-pays principle, and that they wish to minimise the impact of tourism on the fragile ecosystems wherever possible.

### 8.2.10 Other Measures to Protect the Environment

Though the Lake Khuvsgul National Park is still quite unspoilt, the impact of human beings and tourism is visible. One of the most obvious problems is the litter lying around everywhere; but also other aspects could be improved (Fig. 22).

More than half of the tourists (50.5%) spontaneously mentioned solid waste management when asked about other measures to protect the environment in the Khuvsgul area (Q14, n=91, open question, multiple answers possible). Of course, this is a problem that is quickly visible and severely disturbs the aesthetic harmony of a National Park. Though some efforts are made by private organisations, waste management concepts only seem to work well for lodges; the local population is not well integrated in these projects (see chapter 7.3), and their garbage is generally not collected. There is a lack of public waste bins, which makes it difficult to dispose of garbage properly. Suggestions related to the issue of solid waste management include limitations for the use of plastic bags and bottled water, education, and a strict separation and recycling of waste as practised by the informal sector in urban areas.

#### Q 14: What other measures to protect the environment would you suggest and support?

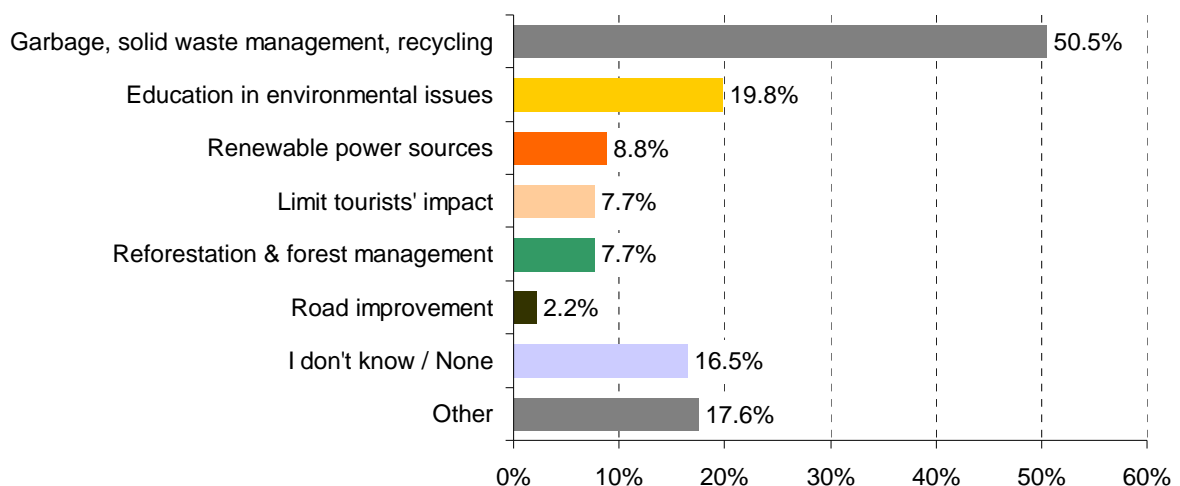

n=91, open question, multiple answers possible  
Source: Own Survey, June - August 2007

**Fig. 22: Measures to protect the environment, tourists' suggestions**

Tourists suggested an array of other measures to protect the environment. The most important measures in their opinion were a better solid waste management, and education in environmental issues.

Education in environmental issues, both for tourists and local people, is acknowledged to be crucial (19.8%). Topic suggestions include waste separation and recycling, education about sanitation and greywater issues, more and better signage in the National Park, training courses to make the local population acknowledge the value of their natural resources, and better herding and forest management practices.

Other suggestions include the installation and use of alternative and renewable power sources (now, mostly gasoline generators are used) (8.8%), and a limitation of the tourists' impact (7.7%), e.g., by restricting their numbers, by introducing stricter standards on eco-tourism, limiting the building of new tourist infrastructures, or by inflicting stricter laws on what is and what is not allowed within the National Park's borders. Some found that roads should be improved: in the absence of paved roads, a whole network of unpaved tracks is quickly established. Every time one track is not good any more, drivers just open up another one a few meters to the side; a practice that contributes to soil erosion.

Suggestions summarised under "others" (17.6%) included the use of biodegradable detergents, a limited use of cars, improvements water transport, or the prevention of air pollution and garbage burning (see also OYUNMUNKH 2008).

### **8.3 Local Population and Ecosan**

Both the community meetings and the observation of sanitation practices showed that there are some problems in relation to sanitation, and that local people are concerned about these issues. They perceive the problems of lodges in relation to sanitation to be bigger than their own sanitation issues, due to the fact that most lodges are usually built very close to the water and use flush toilets. However, local people lack the knowledge about alternative solutions; and they also lack the power to change the situation, as they are usually not involved in any decision making processes.

#### **8.3.1 Awareness of Environmental Problems**

The relationship between humans and nature, or how the environment is perceived as such, is basic information for the development of adequate sanitation solutions. Accordingly, this was the first topic in the community meeting on July 16<sup>th</sup>, 2007. In order to find out more about how the local people from Khatgal perceive their community and their environment, the participants of the first community meeting were first asked to draw a map on Khatgal. The whole group was split in two: one group focused on the town of Khatgal, and the other on the camping area north of Khatgal. The two groups were given the instruction to draw their map with a focus on environmental problems that exist within this area.

##### ***Community Maps of the Town of Khatgal and the Camping Area North of Khatgal***

On the **Khatgal map** (Map 6), it is especially the solid waste problem that becomes apparent. A number of waste dumps are shown at various points within the village (black triangles). As the waste of the local people is not brought to the central dump (see description of current practices, chapter 7.3), it is disposed of in various places within the village, often in crumbling Soviet buildings (Photo 27 and Photo 28), or natural swales.



Photo: J. VON ARX

**Photo 27: Waste dump within the village of Khatgal**

Solid waste management is an unsolved issue in Khatgal. As currently no authority feels responsible to pick up the waste of the local people, their wastes are just dumped in the environment, here, on the foundation of an old building. The location is unsuitable: it lies between the village and the lake, only about 200 m from the shoreline.



Photo: K. CONRADIN

**Photo 28: Waste dump in an old building in Khatgal**

Solid waste is often discharged in old (Soviet) buildings. In order to make it look nicer, the waste is sometimes covered with sawdust.

The waste is frequently covered with sawdust to make it look more appealing. The Khatgal map (Map 6) shows that local people are concerned about the infiltration from the toilets within their compounds: the question mark within the grids that symbolise local people's compounds stands for infiltration and "soil pollution". However, in contrast to the campsite map (Map 7), this infiltration is not always shown to influence the lake directly. What is seen as problematic for the lake are on the one hand the lodges, and on the other hand the boats.

The families' compounds merely contain the sign for soil infiltration, but not for infiltration from toilets. All the families have dry pit latrines and are located quite far from the lake, whereas most lodges' sanitary infrastructure is usually situated very close to the shoreline of the lake; as a consequence, they perceive their own latrines to have less or no influence on the lake. The map on Khatgal furthermore shows a need to plant trees; this is because a lot of dust from the road traffic and the airport is blown into town in dry periods. Trees could help keeping the dust away from the village. Different people stated that since the forest in the airport area has been cut down since the 1950s, there is a lot more wind in the village.

It is noteworthy that the local people see the old rusty boats and the small boat / yacht traffic as a potential threat to the lake water quality. Most of the motors are very unclean two-stroke motors where oil and gasoline drips into the water when the motor is running. Both during the talks with the local people but also with lodge owners, the concern was uttered that the increased water transport activities (due to tourism) could be harmful to the lake and the fish. It was stated by local people that the number of fish have become scarcer in the last 20 years. The reason for this was unambiguously seen in the development of tourism.

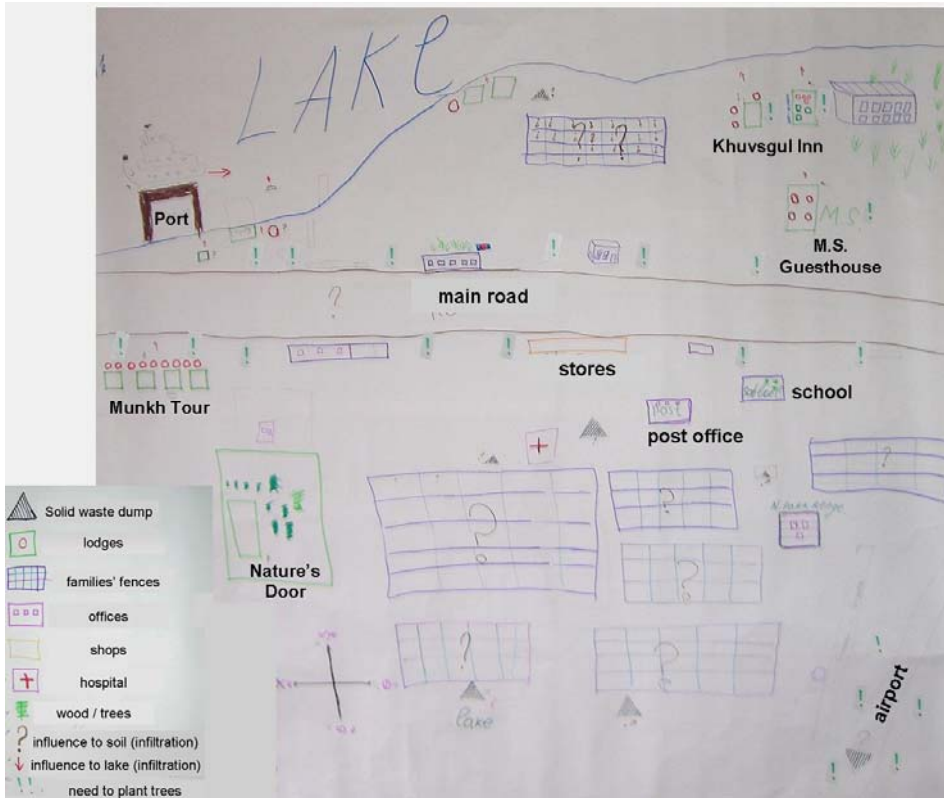

Source: KHATGAL COMMUNITY 2007a

**Map 6: Community map of Khatgal**

The participants of the first community meeting were asked to draw a map of their town. There was a specific focus on environmental issues. The map shows the many illegal waste dumps, and how they influence the soil and eventually the lake (through infiltration). This map also indicates locations where the local people would like to have trees planted.

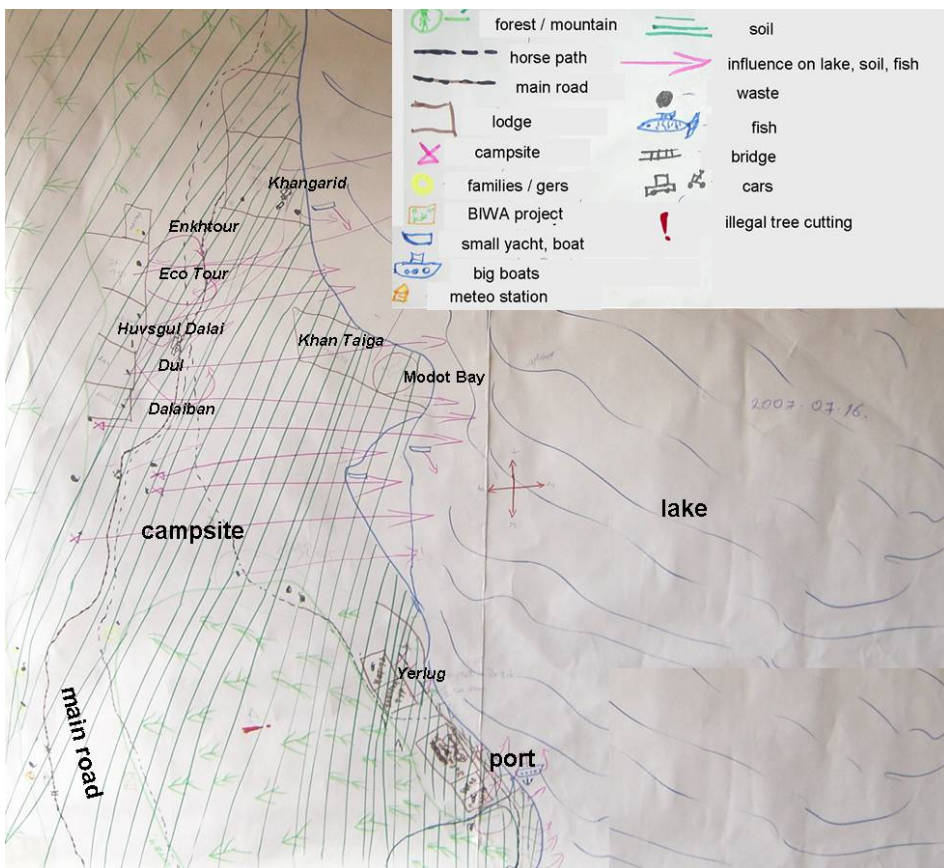

Source: KHATGAL COMMUNITY 2007a

**Map 7: Community map of the camping area north of Khatgal**

The figure on the left shows a map of the camping area north of Khatgal, drawn by participants of the first community meeting, with a focus on environmental problems. The map visualises how lodges – which are all located very close to the lake – and campsites are perceived to influence the lake through infiltration of liquid wastes and runoff from solid wastes.

The **map of the camping area** (Map 7) shows the area to the north of Khatgal. All along the shoreline between Khatgal and Toilogt, there are official camping sites, though they do not usually offer more than a sign and a pit latrine (Photo 29, Photo 30 and Photo 31).



Photos: K. CONRADIN

**Photo 29: Old toilet at campsite north of Khatgal**

This toilet is not in use any more. It is now used as a waste dump. Local people feel that leachate from this toilet could infiltrate the soil and later the lake, as it is not very far from the lake.



**Photo 30: Campsite north of Khatgal**

View in south-eastern direction from the campsite north of Khatgal. Many, especially Mongolian tourists, stay at this campsite which is not too far from town and easily accessible by car.



**Photo 31: Current campsite toilet**

The current toilet at the campsite is a simple pit latrine. It was an often heard claim that campers do not use this toilet, but instead simply use nature to relieve themselves.

The campsites close to Khatgal are the most frequented. This community map made clearer connections between infiltration of liquid waste and the lake: all lodges and campsites are shown to influence the lake by infiltration (pink arrows). Both the toilets in use (of the lodges and the campsites) and the ones that are not in use any more are felt to negatively affect the water quality through infiltration. This was also attributed to the fact that the lodges are usually located much closer to the shoreline than it would be allowed.

Though those who drew this map did not feel like there was any need for reforestation in this area, they noted that there wood was illegally cut in the forest just north of Khatgal. The main road which passes west of the campsite was regarded to cause severe soil degradation and erosion.

### ***Human Impact on the Environment***

In a second task, environmental problems and the human impacts on the environment were discussed. The complex interrelationships between humans and the environment are made explicit by a diagram on human influences on the environment (Fig. 23).

It is worth mentioning that the lake was basically always at the centre of the attention. Nevertheless, the discussion soon revealed conflicts between the various administrative units that are involved in the management of the National Park; these conflicts cause a considerable amount of friction and inhibit the efficient implementation of laws and regulations protect and make sustainable use of nature.

- The first concern of the community meeting participants is **solid waste**. All practices related to solid waste are perceived as negative: air pollution results when the wastes are burnt, the infiltration of liquids from dumps leads to a pollution of the soil, and potentially the water. The current waste dump is viewed as a temporary solution that



needs to be improved, and there should be a possibility to separate and recycle garbage (see also 7.3).

- The second point of importance is **sanitation**, both of the local people and the lodges. Sanitation is viewed as being of pivotal importance for the lodges, because the leaking holding tanks pose a significant threat to the quality of the lake water, which again, leads to a decreasing number of fish and in the end negatively affects humans. The participants were also concerned that there are only two wastewater trucks, and that this was not enough to transport the wastes of all the lodges; illegal dumping and infiltration are the consequences.
- Local people and tourists can negatively influence the **lake** if they wash clothes or cars in the lake, and if they use harmful chemicals.
- Local people can also **positively influence the environment**; one suggestion was for instance reforestation. It was stated that a balanced land coverage could have positive influences on the groundwater level; alternatively, the cutting of large parts of forest could lead to falling groundwater levels and an imbalance in the water household of the area.
- **Lodges** are viewed as a central actor in the man-environment relationship. They influence nature negatively with leaking wastewater containers, cause an increased volume of traffic, which, again, leads to soil erosion along the roads, and occupy an ever increasing area that was previously used as pasture. Furthermore, they often do not adhere to the environmental laws and standards.
- The impact of *foreign tourists* is perceived as relatively small, (though, of course, they travel in cars too), as they usually respect the environment, obey the rules and take their garbage with them. Mongolian tourists, on the other hand, would not care about the environment and would not respect any regulations.
- Another important issue for local people is the **soil erosion** that results from the higher traffic volume due to tourism, and the lack of a good traffic regulation.
- Frequently, also the **decreasing area that is available for grazing** livestock was mentioned; though this may not be an environmental problem per se, it demonstrates the importance of a balanced and sustainable land use.
- Another central point of the discussion was conflicts between the **different administrative units** in the Khatgal area. Through this inefficient management, resources are not spent there where it would be necessary, and an efficient protection of the environment is made impossible. Administratively, Khatgal is a bagh (community) that belongs to the Alag Erdene soum. Within this political framework, also the National Park administration and the Ministry of Nature and Environment have their say, but the responsibilities and powers are not clearly defined, and the people of Khatgal perceive that decisions which affect them are often made without their involvement by the soum administration or the ministry.

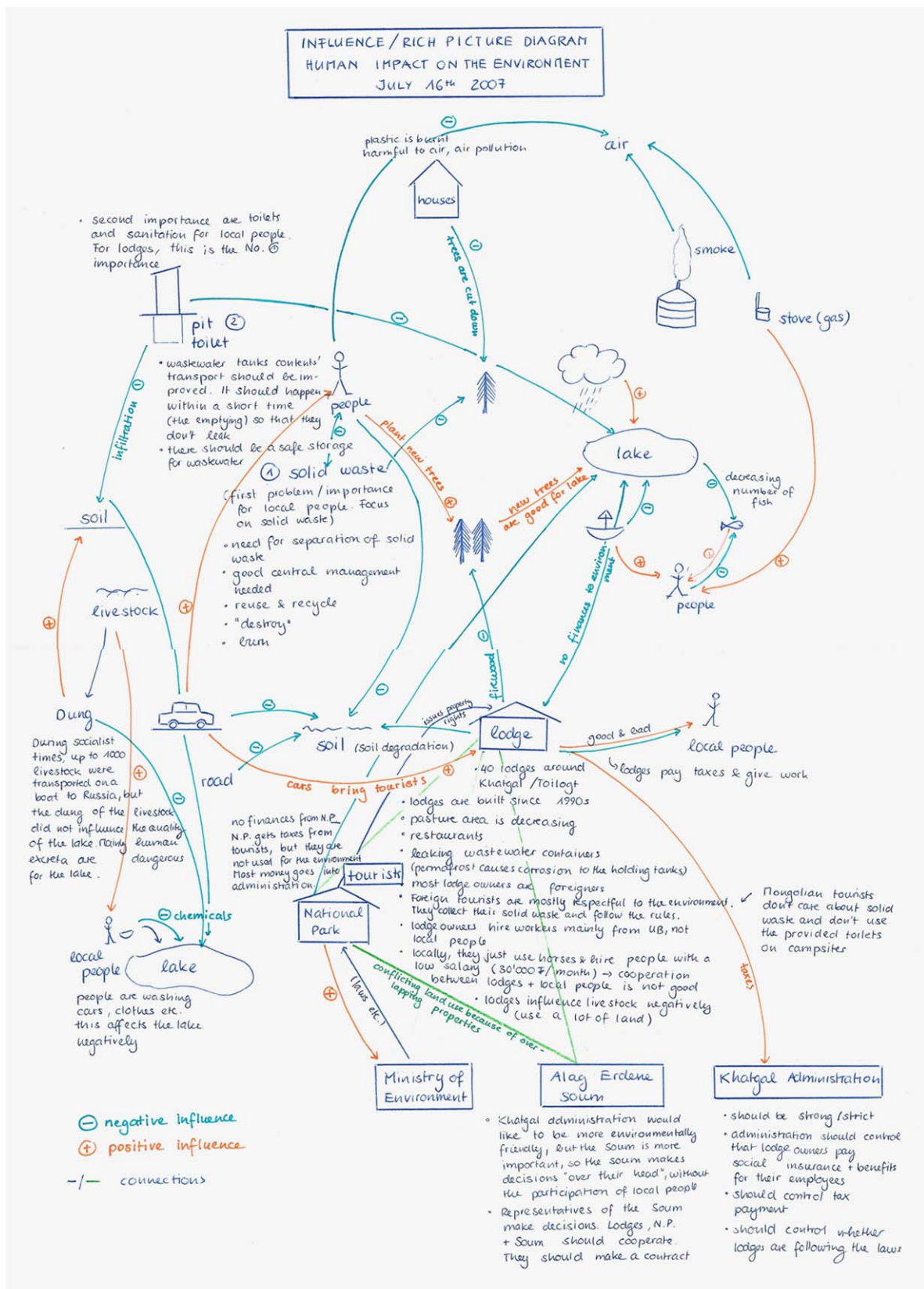

Source: KHATGAL COMMUNITY 2007a

**Fig. 23: Rich picture/influence diagram on human impacts on the environment**

In the first community meeting, local people have described a variety of factors how humans impact the environment in a very complex manner. Orange arrows describe positive influences, blue arrows describe negative influences. The influences are also shaped by the ways the area around Khatgal is administered and managed. It is visible that conflicts between different administrative units lead to a decreased efficiency in the management of protected areas.

- Local people deplore a **lack of involvement** in decision making processes within the Khatgal community itself. Consequences of these conflicting and unclear responsibilities are the non-implementation of existing environmental laws, a weak control, and a series of land use conflicts where the same land is appropriated to different parties.

These problems are mostly not adequately tackled because of weak law enforcement, unclear responsibilities between the different administrative units, inflexible and mal-adjusted governance and/or management structures and a general lack of local people's participation in decision making processes.

### 8.3.2 Influences of Tourism in the Lake Khuvsgul Area

Though tourism certainly is an important economic factor in Mongolia, the local population of Khatgal does not only view it positively. As the implementation of new sanitation technologies for tourists also affects the local population, it is relevant to quickly assess the general influences of tourism on the local population from their perspective.

- Tourism enables local people to generate **additional income**. Local people benefit from operating their own, small guesthouses, from selling handicrafts, by having more clients in food stores or restaurants, and by working as guides. The employment in lodges is not a major source of income.
- It is **criticised** that lodges **do not hire many local people**, and that they mostly bring their own staff from Ulaanbaatar. If lodges hire local people, they are often employed only in the lowest positions, or as guides, where the largest share of what the tourists pay remains with the lodges. Additionally, it was criticised that lodges do not issue contracts for the employees. If employees stand up for their rights (i.e., working hours, social benefits, adequate wages etc.) lodge owners usually lay them off. They can easily find a substitute among the many unemployed who are willing to work for a very low payment. The non-compliance with existing laws is not prosecuted, neither by the administration of Khatgal nor the Alag Erdene soum.
- Tourism has led to increasing conflicts over **land use**. Large parts of the areas that were previously used as pasture for animals have now been converted to lodges. The local people additionally deplore that they are disadvantaged in land issues, as land is rather given lodges, which will pay taxes.
- A large part of the discussion was devoted to **campsite management**. This is perceived as largely inexistent and very ineffective, not at least because the rangers that are responsible for this in addition to their regular jobs, do not get any financial benefits for their surplus work. Sanitation on campsites is perceived as a really big issue, because the toilets are usually located close to the lake and not maintained well. Thus, many tourists just relieve themselves in nature.

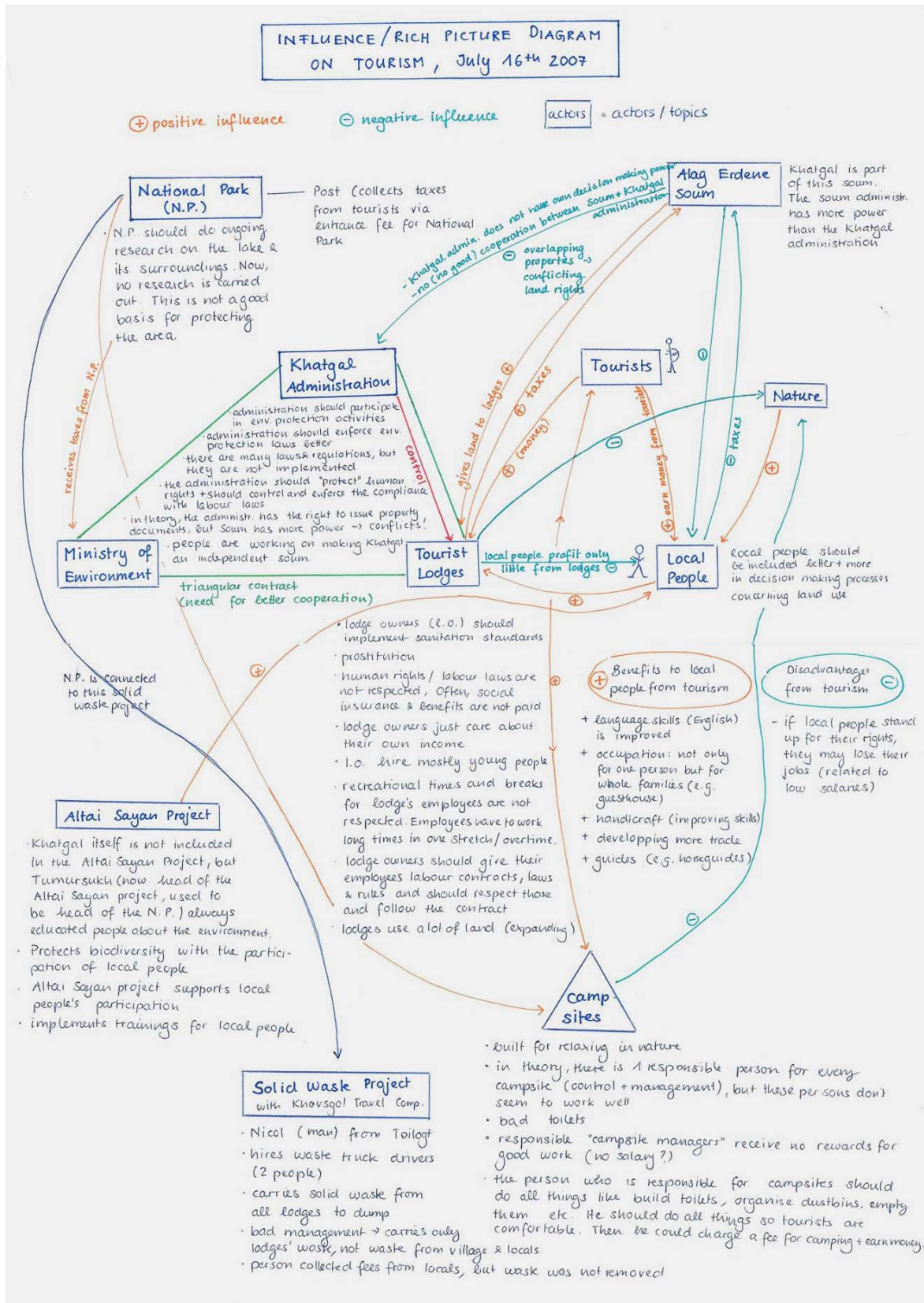

Source: KHATGAL COMMUNITY 2007a

**Fig. 24: Rich picture/influence diagram on impacts of tourism**

The above influence diagram shows the interrelationships between tourism and the local people. Orange arrows show positive influences, and blue arrows negative ones. Conflicts between the different administrative units over responsibilities are crucial.

- Again, there was a lengthy discussion on rights and duties of the different administrative units, and the **unfair and intransparent distribution of taxes** (from lodges and tourists' entrance fees to the National Park) between the soum, Khatgal, and the National Park. It was furthermore criticised that the National Park would not spend generated money on environmental protection, and that its work remains mainly invisible for the local people. There is a general desire to be more included in decision making processes, and the cooperation between the National Park, the Khatgal administration, lodges, and the ministry of nature and environment (which is involved in land use decisions) should be improved.

### 8.3.3 Problems with Current Sanitation Systems

An important factor for the acceptance of new sanitation system is whether the current system fulfils all needs and is satisfactory. If there are problems with the current system and people are looking for alternatives, they will be more ready to switch to alternative systems.

In order to find out about difficulties with current sanitation systems, the participants of the second community meeting on July 17<sup>th</sup>, 2007 were asked to list their concerns in a problem tree (see Fig. 25).

- The largest issue in relation to current sanitation practices are **hygienic risks**. Though the participants said that there were not many cases of illnesses, and that it could not be clearly stated whether these illnesses are actually caused by unhygienic sanitation practices and leakage, they are very concerned about infiltration of leachate into the soil and the lake.<sup>28</sup> Local people are especially worried about the lack of sanitation at the campsites, and lodges' current practices (leaks, infiltration of untreated wastewater). Families' practices are not deemed critical, as they all use dry toilets and are all located far away from the lake. Though nothing has happened *yet*, local people are extremely worried about the potential pollution of their living space and their only source of drinking water and greatly welcome systems that would prevent pollution at its roots.
- Related to this is the issue of **lacking management and control** and poorly defined responsibilities. Tourist lodges often evade the regulations. Furthermore, there are not enough trucks to transport all the wastewater of the lodges. In any case, local people view the transferral of liquid waste to the central dump as a provisional solution, and the dump itself in need of serious improvement (e.g. lining and prevention of infiltration). Local people would favour solutions that make the sanitation of lodges and campsites safer and easier to control, and suggest that the responsibility for waste management should be transferred to a person who is independent from the local administration.

<sup>28</sup> An interview with a team of Korean doctors that were present in Khatgal during one week in August 2007, confirmed this. Dr. Myung stated that diarrhoeal diseases are not very common in Khatgal. Nevertheless, they also state that while they had no case of diarrhoea or gastrointestinal diseases in the Darkhan Valley, a very remote and extremely scarcely populated valley northwest of Khatgal, they had about 20 cases during their time in Khatgal (out of a total of 800 patients) (MYUNG 2007).

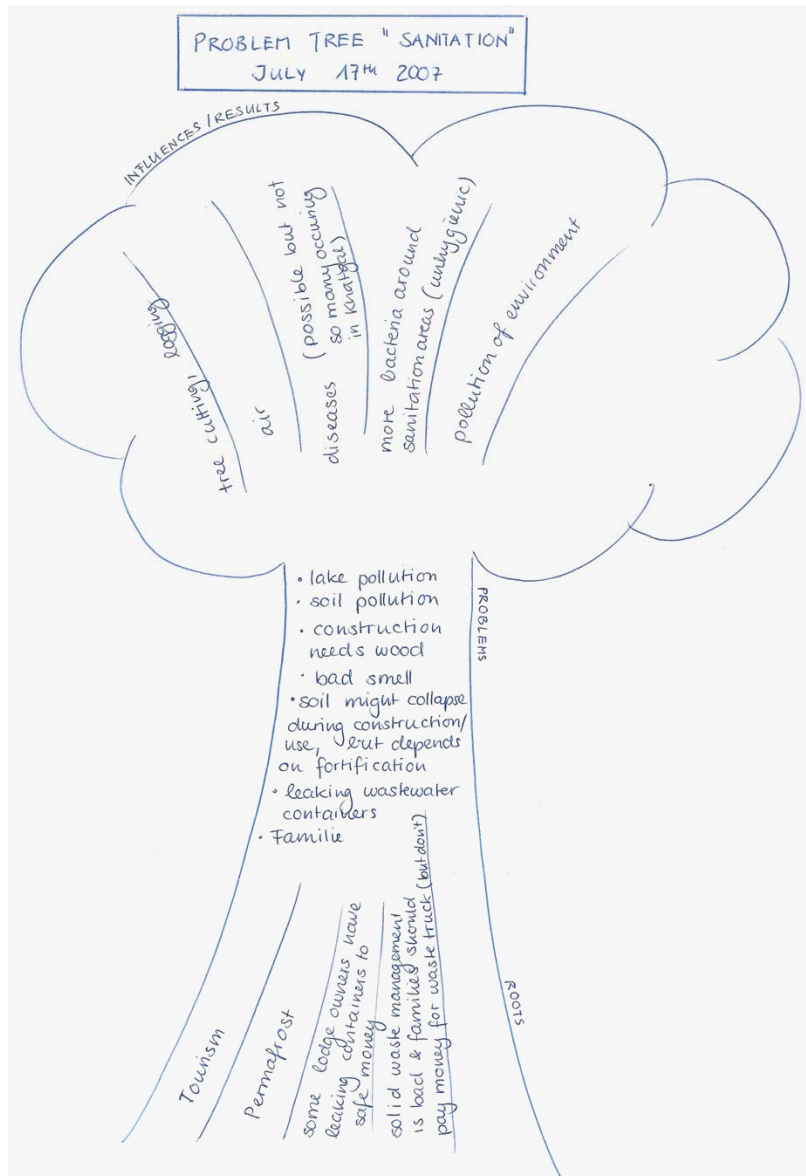

Source: KHATGAL COMMUNITY 2007b

**Fig. 25: Problem tree on sanitation**

The participants of the second community meeting were asked to draw the problems they perceive with current sanitation technologies in the shape of a problem tree. The roots symbolise the roots of the problems, the stem shows the problems as such, and the crown contains potential results and/or consequences of the problem. Local people see problems on several levels: pollution, problems in relation to the construction of the toilets, and problems concerning the lodges' sanitation.

- Further problems relate to user comfort, especially the stench of the toilets during the summer. This is perceived to be a very big problem. Improvements in user comfort would be very welcome.
- The construction of toilets is difficult due to permafrost and high groundwater tables. This makes it necessary to fortify pits: a laborious process that is not always successful. For this reason, local people were very interested in alternative solutions that would allow them to build toilets completely above the ground level.

### 8.3.4 Attitude towards Ecosan

As has been shown in the previous subchapter, there are problems in relation to current sanitation practices, and local people are very worried about those issues. As described, local people are genuinely interested in alternatives because they think ecosan toilets would lead to

- hygienic improvements and prevention of pollution,
- a better management and easier control,
- increased user comfort,
- and would help to tackle current construction problems.

However, also the following issues have a great impact on the attitude towards ecosan in the Khatgal area as well. As in the case of lodge owners, maintenance is the most debated issue:

- In general, local people think that the **maintenance** of ecosan toilets could be administered by the families themselves. It is assumed that local families would maintain the ecosan toilets in a responsible and proper way. However, it must be considered that this view might be influenced by the fear of additional costs for a central management. In addition, there is a distrust in central management from the local people's point of view because – as the example of solid waste shows – it only seems to work well for lodges.

Despite this reasoning, the majority of the local people seem to favour a centralised and professional management of the excreta for reuse for all ecosan toilets. This has several reasons: Firstly, it reflects the deep distrust that local people feel towards lodges and their management. They repeatedly expressed the concern that though the concept as such would be very environmentally friendly, the lodges would not adhere to it and would just empty non-sanitised excreta wherever in their surroundings. This would of course lead to a deterioration of the current situation. Secondly, there is still a certain scepticism whether excreta are really properly hygienised after their in-situ treatment process (dehydration and storage for faeces and urine, respectively). Local people believe that a centralised management could make sure that everybody's toilets are managed properly and could guarantee that the necessary standards and procedures are obeyed. Thirdly, a centralised treatment has a psychological effect similar to the one of a black box: Wastes are removed, something happens to them (that is not quite thoroughly understood, but trusted), and a clean and hygienic product which has lost all its similarity to what it originally was results; it thus greatly heightens acceptance. Fourthly, local people opted for a new structure in how this centralised maintenance should be planned: It should not be an organisation that is under the control of the Khatgal administration, but an independent enterprise that could guarantee a high level of safety and high quality work both to local people and to lodges. A fifth point is that an ecosan toilet is more labour intensive than a simple pit latrine. If there were a professional service provider, this disadvantage could be eliminated.

- A second issue with a great influence on the future acceptance of ecosan toilets are their **costs**. Currently, a common, simple pit latrine for families with a pit the size of

2x2x3 m can be locally built for about 100'000 MNT: about 40'000 MNT for digging the pit, and about 50'000 MNT for the wood (KHATGAL COMMUNITY 2007a). A very basic, one-vault UDD toilet, would cost about 50% more, i.e. 150'000, if the seat is constructed locally, and if labour is not included in the costs (BAYANJARGAL 2007). Though sanitation is regarded as a crucial issue, most families will not be able or willing to pay much more for an environmentally friendly toilet, especially because they believe that it is not them who are responsible for the pollution, but the lodges and campsites.

- A good, independent and professional **control** of ecosan systems is the third factor which has to be considered vital for a successful implementation from the outcomes of the community meetings. Local people have to be sure that this system leads to an improvement of the hygienic situation and can prevent pollution. A rigid implementation of sanitation standards and systematic controls on the end product are essentially crucial for raising the acceptance of reuse.
- Likewise, and corresponding to the former point, it is very important that the research results concerning hygienic aspects are made **public**. The acceptance of any new system or procedure is in any case essentially based on a mutual trust and a thorough understanding of the ideas and processes behind this alternative, but is the more important for systems that deal with tabooed subjects. Local people specifically wished to be involved in decision making processes and implementation of ecosan systems.
- There is a need for **awareness raising and education**, both for the construction, maintenance and the actual use of the toilet. Education and awareness raising was also perceived crucial for the acceptance of different reuse concepts.
- It would make sense to build **urinals for men**. Men would not have to sit down to use the toilet, and the easy and totally separate collection of urine is facilitated. This would boost men's acceptance of separation toilets. Care should be taken that the material for the urinal is frost resistant.

### 8.3.5 Ecosan in Winter

A substantial part of both ecosan discussions was dedicated to the issue of ecosan during the wintertime. The following suggestions were discussed:

- At temperatures that regularly drop to -40°C or less in the winter, the **design** of the toilets has to be adapted carefully. Currently, all toilets are located outside, and it is not probable that this will change in the near future. Therefore, toilets that are going to be used in the winter as well should get by without any pipes, as urine would freeze in the pipe. It is necessary that the urine funnel of the UDD toilet is large enough so that it does not freeze right away. As evaporation is not an issue during winter, urine containers could just be left open, though it may be possible that more ammonia forms in this way (RICHERT-STINTZING 2007: 13f.).
- Similarly, the **seats** of the toilet must be equipped with heat insulating materials (such as Styrofoam) to increase the user comfort.
- The **reuse concept** has to be adapted. Either, people need a storage volume that is large enough to be used all winter (which should not be problematic for faeces), or one



must be able to remove the frozen urine in wintertime. Though the solution discussed during the community meeting might at first seem amusing, it does indeed make sense at a second thought: Instead of taking canisters to store the urine in the wintertime, simple buckets which are tapered at the bottom could be placed under the toilet. These buckets would then freeze, and the frozen urine could be popped out of the bucket like an oversized ice cube<sup>29</sup>. These “urine cubes” could then be placed directly at the plants that need fertilization and thaw in the spring together with the snow. Frozen urine cubes could easily be transported on a simple truck in the winter. Several participants mentioned that where there is no possibility to dig a new latrine, pit latrines were often emptied in the winter when their contents are frozen. The practice of applying frozen excreta to agricultural fields is common in northern China, Tibet or Siberia (ENKHTUVSHIN 2007). This solution would make it unnecessary for families to buy a large number of storage containers – a concern that was often raised because it can get quite expensive. For lodges, it would be possible to build tanks with a sufficient volume for the whole winter, and urine could be pumped when it has again thawed.

- Similarly, the **design for the collection of faeces** has to be adapted. Good results were made by the GTZ pilot project in Ulaanbaatar (see 3.4.2), where an additional mesh in the faeces collection chamber provided such good aeration that the formation of excreta “stalagmites” could be prevented through an excellent air flow. Given this, it should not be difficult to provide a storage volume that suffices for the whole winter, as the volume of faeces is relatively small.
- Another option – though more expensive – would be to install **solar panels** to heat the toilet buildings (which would of course make a solid insulation necessary) as described in LINDBLOM (2006: 51).<sup>30</sup>

### 8.3.6 Acceptance of Reuse Concepts

As was expected, the participants of the two community meetings were sceptic towards the reuse of ecosan fertilizer for vegetables. However, the detailed analysis of the two discussions on ecosan in both community meetings (see Fig. 26 and Fig. 27 on the following pages) also showed that certain reuse concepts should be very well feasible even in Mongolia.

#### ***Silviculture and Reforestation***

The planting of trees and their fertilization with ecosan fertilizer is clearly the most widely accepted reuse option. Both community groups evidently favoured this concept, as the fertilizer is not needed for anything that might be eaten afterwards. The participants of the community meetings recognized a need to manage the forests sustainably. Silviculture and reforestation can be recommended unrestrictedly in the Khatgal area.

<sup>29</sup> This idea was also extensively discussed on the ecosanres discussion forum, e.g. by MADIN (2006, Oct. 15<sup>th</sup>. Internet) <http://tech.groups.yahoo.com/group/ecosanres/>

<sup>30</sup> More information on urine diversion in cold climates can be found in the following publication: RICHERT STINTZING, A. ET AL. (2007): Urine Diverting Toilets in Climates with Cold Winters. Technical Considerations and the Reuse of Nutrients with a Focus on Legal and Hygienic Aspects. Utrecht & Munich: WECF (Women in Europe for a Common Future).

***Berries and Sea Buckthorn***

Berries and sea buckthorn were considered the second best alternative in the Khatgal region. The predominant opinion was that both the soil and roots of the plants filter the ecosan fertilizer, so only beneficial components of the fertilizer would be taken up. The same was said of all fruit trees or berries. Nevertheless, it was argued that the fertilizer could change the structure and characteristics of the plant, and experiments should be carried out locally before applying this concept on a wider scale. It was suggested that the use of ecosan fertilizer for sea buckthorn could result in economic benefits due to the better harvest.

***Agriculture and Animal Forage***

The acceptance for agricultural produce and animal fodder was low. This is mainly due to climatic reasons: In Khatgal, it is too cold for agriculture; it is not practised and was not thought to be a sensible reuse option. Local people saw no need for producing additional animal fodder, as they can get sufficient hay and grass from the meadows surrounding Lake Khuvsgul, a tradition that has been practised for hundreds of years. This reuse option will not receive much support, neither by the local population, nor by lodge owners.

***Vegetable Production***

The acceptance for vegetables produced with ecosan fertilizer was, as expected, low. Though vegetables are eaten in Mongolia, they usually do not constitute an important part of the local diet. Most people thought further experiments were necessary to show that using ecosan fertilizer on vegetables was safe before they would be willing to accept them. This is understandable because root crops such as potatoes, carrots, beets, onions, turnip etc., which would be in direct contact with the fertilizer, are the main vegetables that grow in Khatgal. Still, some people argued (analogous to the lodge owners) that Mongolia now obtained much of its vegetable imports from China, where one did not know at all what was put on the vegetables to fertilize them. Those people contended that it would actually be safer to use the own ecosan fertilizer, where one knew that it had been hygienised and was safe. They generally thought that with awareness raising and a demonstration garden, it would be possible to convince local people. They also stated that other sorts of vegetables could be grown in greenhouses (e.g. tomatoes and cucumbers). However, the prime focus in Khatgal should not lie in promoting vegetable production; due to the short growth period and the limited consumption, it will most likely not be overly successful on a family level.

It furthermore has to be taken into account that quite large areas are necessary for the reuse of fertilizer: If no local recommendations can be obtained, a rule of thumb [for urine] is to apply the urine produced by one person during one day (24 hours) to one square metre of land per growing season. If all urine is collected, this will fertilize 300 to 400 m<sup>2</sup> of crop per person/year with nitrogen at a reasonable rate. For most crops, the maximum application rate, before risking toxic effects, is at least four times this dosage. If the application rate is chosen to replace the phosphorus removed, even larger areas can be fertilized (JÖNSSON ET AL. 2004: 1). Plant species that grow locally usually have relatively low nutrient requirements, and the short growth period naturally limits the uptake of nutrients, all of which makes the space requirements for reuse in Mongolia larger than in other countries. The area used for faeces for this is usually much smaller, especially when used to improve the soil structure.

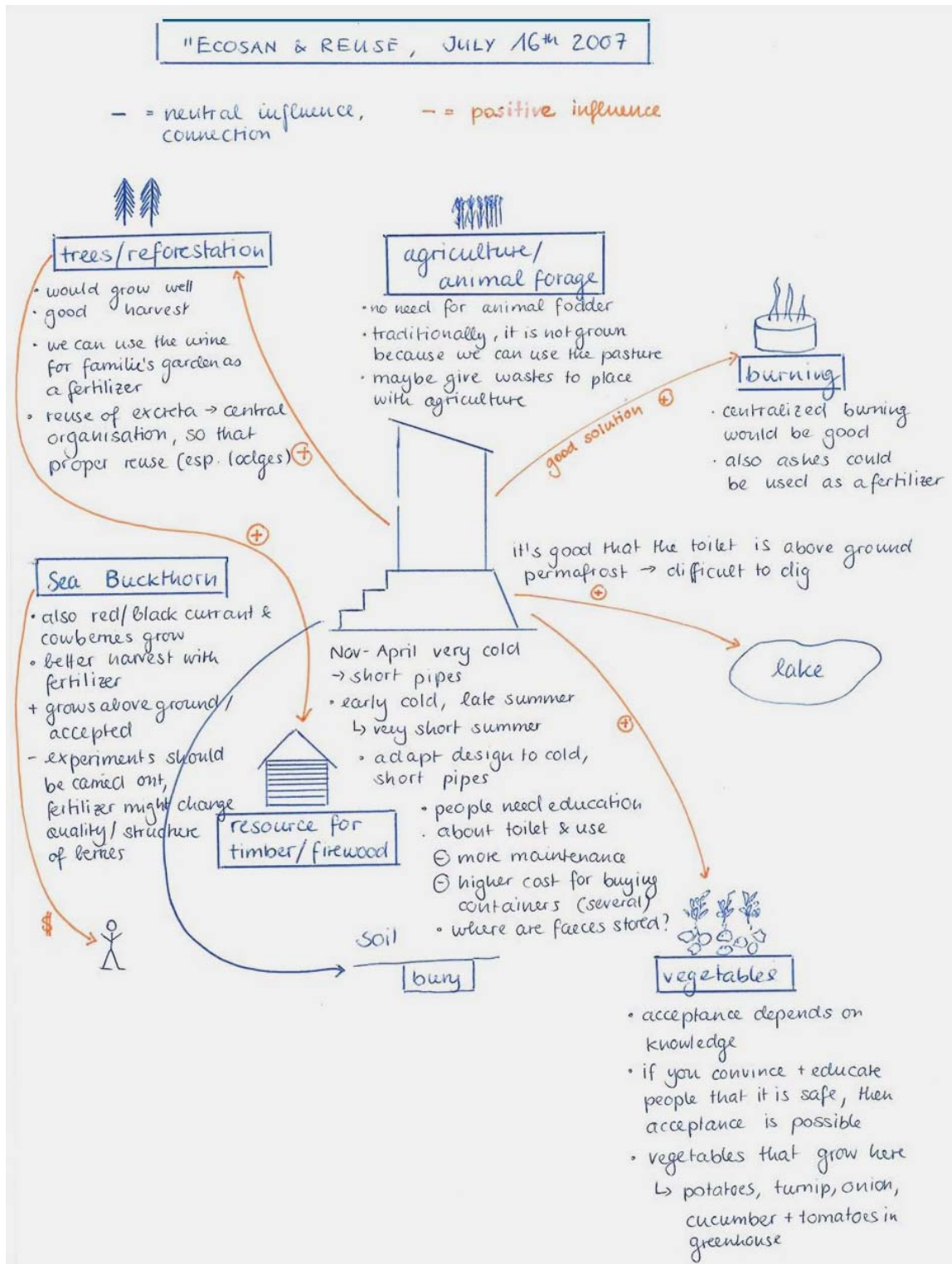

Source: KHATGAL COMMUNITY 2007a

**Fig. 26: Advantages and disadvantages of ecosan, first community meeting**

After the participants of the first community meeting had seen the ecosan pilot toilet on a guided tour, they were asked to discuss the advantages and disadvantages of ecosan and various reuse concepts. A simple drawing with the ecosan toilet in its centre served as a basis. The participants then discussed issues and aspects of reuse according to their own interests. They viewed the effects of the toilet and fertilizer as beneficial per se. The reuse options that were most widely accepted were reforestation and sea buckthorn. Some people argued it would be easiest to just burn the dried faeces and not bother about reuse, although other also noted the economic advantage of using ecosan fertilizer, e.g. for sea buckthorn.

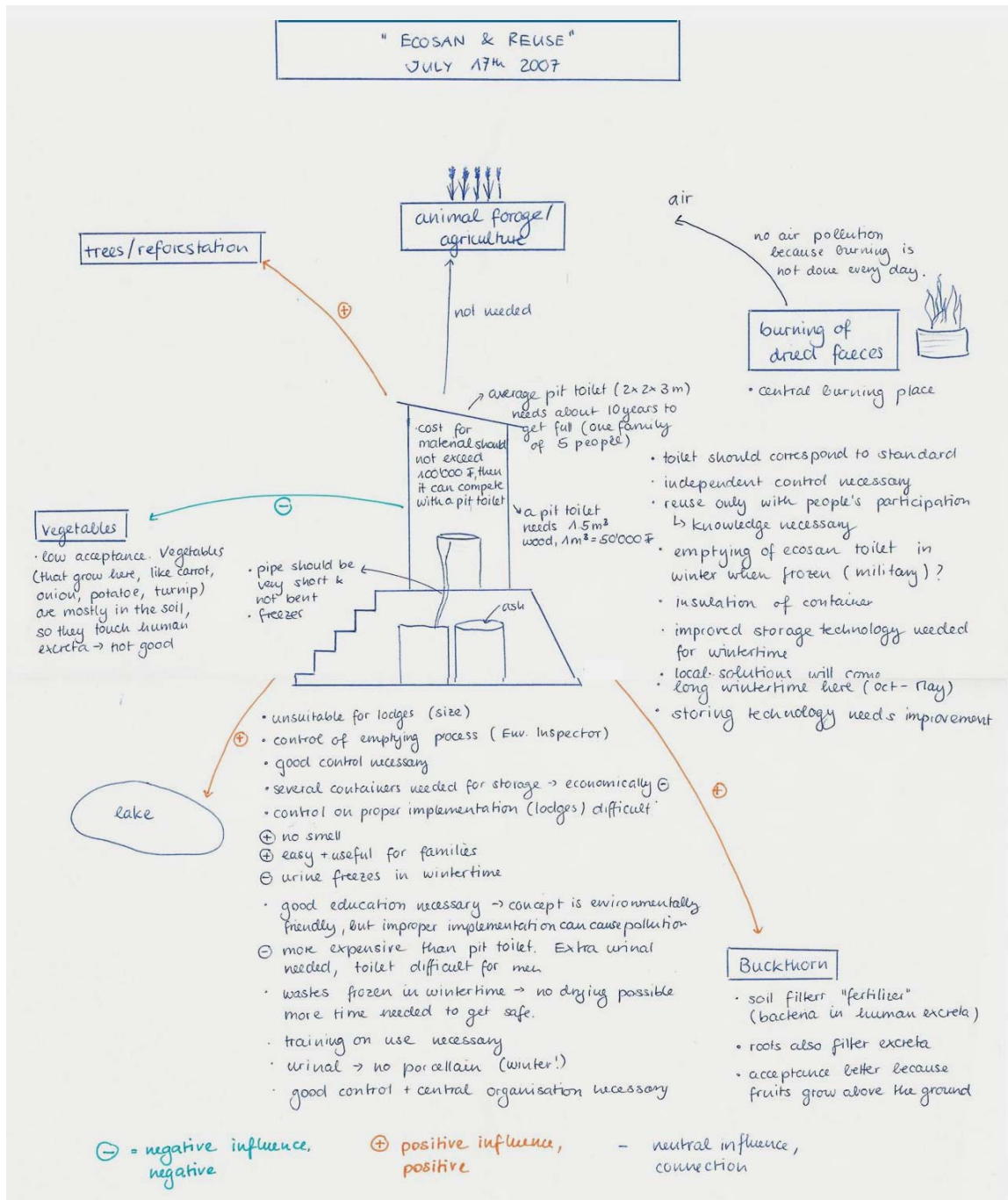

Source: KHATGAL COMMUNITY 2007b

**Fig. 27: Advantages and disadvantages of ecosan, second community meeting**

Also the participants of the second community meeting were shown the toilet and then asked to discuss ecosan and its various influences on the environment, the effects of ecosan fertilizer, and advantages and disadvantages of the ecosan concept. Again, most influences were seen as positive, but in contrast to the first group, the second group was totally averse to vegetable production. There were some people in the second group who thought it the easiest solution to burn the faeces. However, the acceptance for berries or reforestation was equally high.

***Other Ideas Exclusive of Reuse***

The above analysis shows that certain reuse options are very well feasible in Mongolia; and the community meeting participants had low to no inhibitions to reuse urine. The acceptance for the reuse of sanitised faeces was generally lower. Some participants argued that it would be the easiest solution to just burn the dried faeces. This would render an absolutely safe product where none of the pathogens survive. An obvious reason for this is probably that it is a very simple solution and does not need additional labour for reuse. Furthermore, some people thought that there would be no need to reuse the nutrients contained in human excreta, as there would be enough animal dung locally. But hidden in this idea is probably also the ulterior motive that this would be an easy and practicable option also for lodges; like this, they would not discharge untreated excreta into the environment.

Other people argued that the end product could simply be buried or disposed of in the forest when it was sanitised; they put forward that nutrients were also brought back into the environment like this. Again, this is most likely due to the fact that individual reuse is seen as an additional burden.

Nevertheless, in general, the value of fertilizer and the benefits it can have on plants was very well recognized, and the acceptance for centralised reuse-concepts which involve non-food crops is certainly quite high.

**8.4 Trial Garden**

The trial garden that was established in Khatgal served to study the effects of fertilizer in a soil that was previously not used for agricultural purposes in northern Mongolia. However, in order to make a conclusive statement on the growth of the plants, larger plots and a longer test period over several years would be necessary; the results of this part of the study hence rather have an illustrative character. The chemical analyses of the soils are described in VON ARX 2008. The main purpose of this garden was to demonstrate local people and tourists, who were both visiting the toilet in significant numbers, the effects of urine fertilizer.

The fertilization with urine clearly proved to be effective (for an exact description of methods, see chapter 4.5). After ten weeks of growth, significant differences were visible (Fig. 28). Each column received different amounts of fertilizer and water: Column 1 and 2 were not fertilized at all, with only column 2 irrigated when necessary. Column 3 and 4 received a low rate of fertilizer (1.5 L/m<sup>2</sup> per growing season), with only column 4 receiving additional irrigation. Column 5 and 6 were given a high rate of urine (6 L/m<sup>2</sup> per growing season), with column 6 receiving additional irrigation

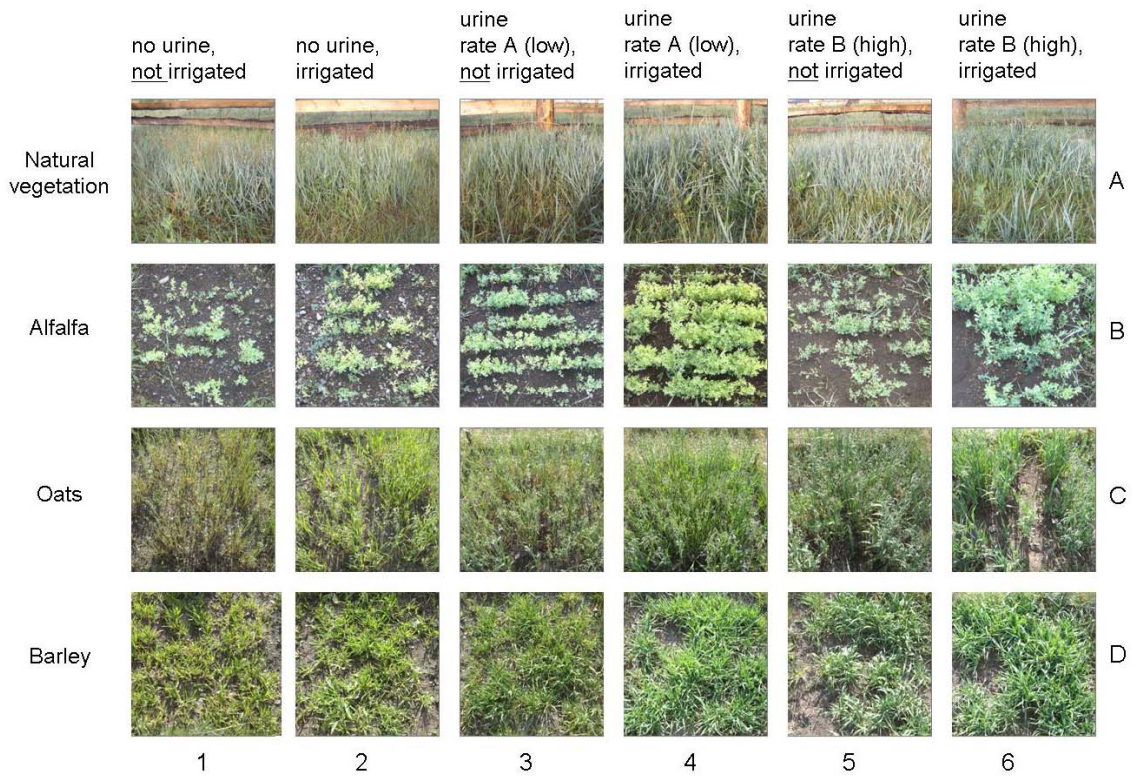

Photos and Graphics: K. CONRADIN

**Fig. 28: “Aerial view” of the trial garden after ten weeks of growth**

The different columns each received different amounts of fertilizer and water. The results in growth density can be clearly tracked from left to right. Rows on the left side tend to have yellowish leaves (due to drought stress, and possibly a lack of nutrients) and a less dense growth, while rows on the right are deep green and dense.

The colour and growth density differences of the individual rows become more clearly apparent in the following picture (Fig. 29):

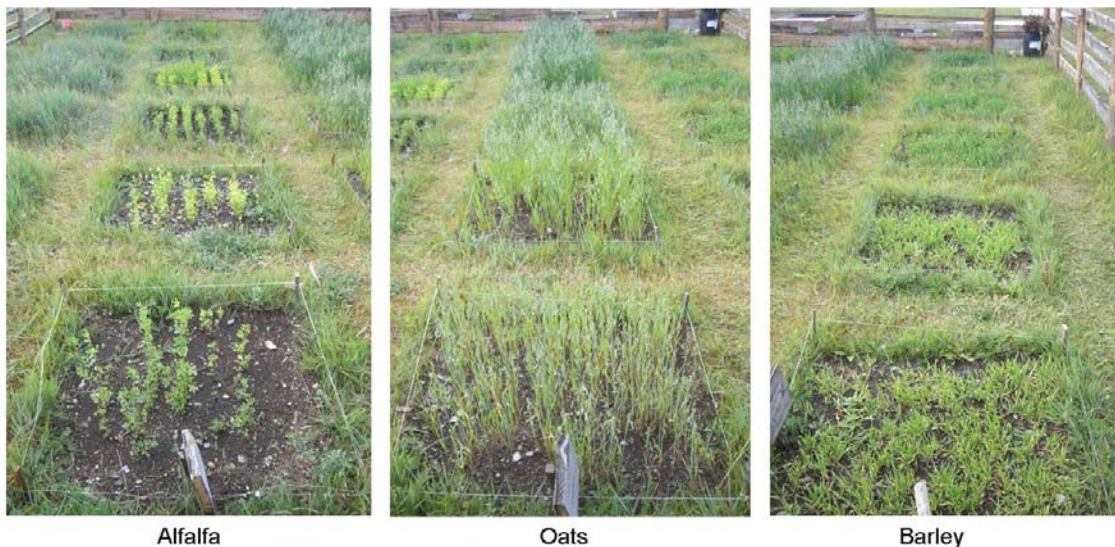

Photos: K. CONRADIN

**Fig. 29: Alfalfa, oats and barley after ten weeks of growth**

The first plots represents column one, which neither received fertilizer nor water. The last plot visible is column six, which was given a high rate of fertilizer and was additionally irrigated. The differences in colour and plant density are clearly visible, especially with oats.

As the following figure (Fig. 30) shows, there were significant height differences in the test fields after ten weeks of growth. These differences can be unambiguously put down both to the additional irrigation and the fertilization.

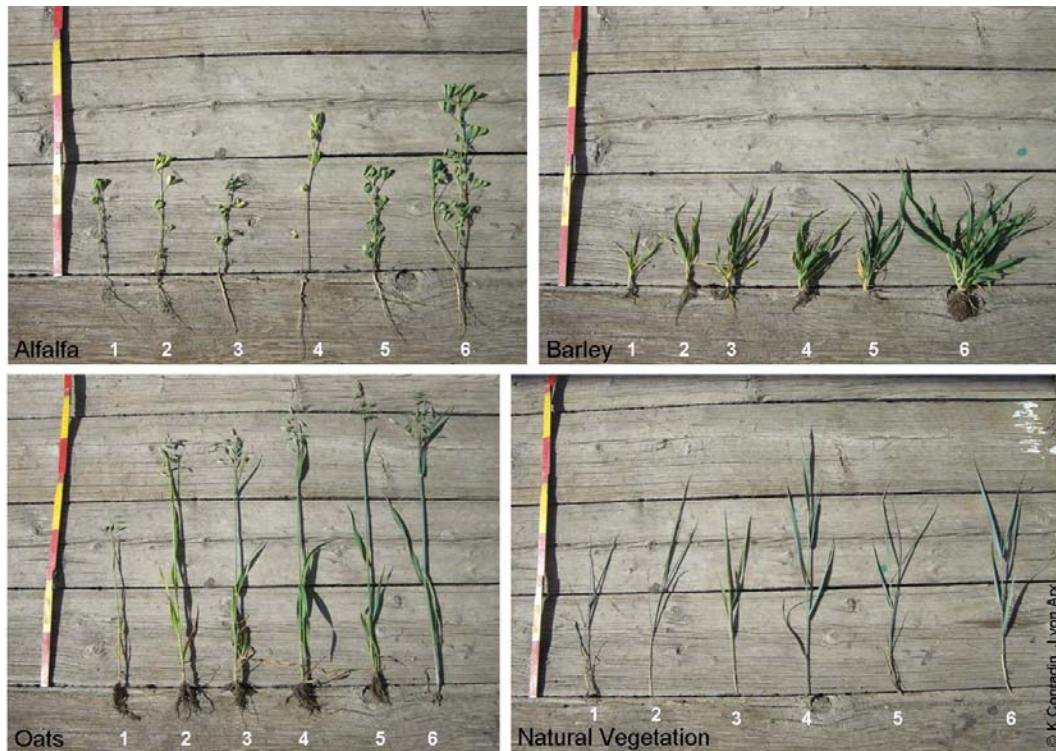

Photos: K. Conradin

**Fig. 30: Individual fertilized and non-fertilized plants after ten weeks of growth**

The rows were irrigated and fertilized according to the scheme described above. While very good results are visible with oats and barley, corresponding exactly to the amount of fertilizer and water received, the height of the alfalfa plants is heavily influenced by irrigation. It is difficult to see clear results with the natural vegetation here, though some trend (darker colour, greater height) is visible from left to right in the test plots.

#### 8.4.1 Alfalfa



**Photo 32: Individual alfalfa plants**

Individual alfalfa plants after ten weeks of growth. The fertilization was carried out according to the scheme described above. The different growth heights were mainly due to irrigation, and less to urine fertilization.

fields 2 and 4 were lighter than plants in other plots; an anomaly that can possibly be explained by a soil analysis (see VON ARX 2008).

Column four in the following table highlights the differences by comparing the average height of the plants (it must, however, be noted that this is only a comparison of heights and does not into account other factors such as colour, plant density or ramification). The average

plant in plot 6 is 75% bigger than the average plant in plot 1; and substantial differences in growth were detectable between those plots that were irrigated and fertilized: the plants in plot 4, which was irrigated and given a low dose of fertilizer were on average 17% bigger than the plants in plot 2, and the plants in plot 6 were on average 75% bigger than the plants in plot 2.

No.	Fertilization and Irrigation	Height	Avg. Height % of plot 1	Colour	Plot condition	Other remarks
			August 14 <sup>th</sup>			no blossoms at all
1	no urine, <b>not</b> irrigated	10 – 30 cm, all slightly different	20cm 100%	light green	quite a few stones	few plants
2	no urine, irrigated	15 – 25 cm, mostly 16 – 20 cm	20cm 100%	light green	quite a few stones	relatively few plants
3	urine rate a (low), <b>not</b> irrigated	10 – 20 cm, mostly 15 – 17 cm	15cm 75%	green	hardly any stones	many plants
4	urine rate a (low), irrigated	17 – 30 cm, mostly 20 – 25 cm	23.5cm 117%	(light) green	hardly any stones	many plants
5	urine rate b (high), <b>not</b> irrigated	10 – 22 cm	16cm 80%	dark green	hardly any stones	relatively few plants
6	urine rate b (high), irrigated	25 – 45 cm	35cm 175%	dark green	hardly any stones	plants concentrated on one side

**Table 1: Analysis of alfalfa growth in different test plots**

### 8.4.2 Barley



**Photo 33: Individual barley plants**

Individual barley plants after ten weeks of growth. The fertilization was carried out according to the scheme described above. Different growth heights are both due to fertilization and irrigation.

Barley responded very well both to fertilization and irrigation (Table 2 and Photo 33). The plants in the different test plots are increasingly bigger and stronger from left to right, i.e., with increasing fertilizer and water amounts. Here, the effect of the fertilizer is clearly visible. The plants in those columns which received urine fertilizer are persistently larger and more ramified. There is also a colour difference: the plants in the first column are yellowish and light, and the plants in the last column dark green. This is possibly an indicator that the plants in the natural soil lack certain nutrients and/or suffer from drought stress.



Barley						
No.	Fertilization and Irrigation	Height	Average Height % of plot No. 1	Colour	Plot condition	Other remarks
			August 14 <sup>th</sup>			no blossoms at all
1	no urine, not irrigated	5 – 10 cm, mostly 7 cm	7.5 cm 100%	light green	some stones	many yellowish leaves
2	no urine, irrigated	8 – 12 cm, mostly 10 cm	10 cm 133%	light green	little stones	sporadically yellow leaves
3	urine rate a (low), not irrigated	11 – 19 cm, mostly 15 cm	15 cm 200%	(light) green	some stones	
4	urine rate a (low), irrigated	13 – 21 cm, mostly 17 cm	17 cm 226%	green	little stones	
5	urine rate b (high), not irrigated	15 – 24 cm, mostly 17 cm	19.5 cm 260%	dark green	little stones	
6	urine rate b (high), irrigated	15 – 30 cm, mostly 20 cm	22.5 cm 300%	dark green	some stones	

**Table 2: Analysis of barley growth in different test plots**

As Table 2 shows, the average plant height gets increasingly bigger; a clear indicator that the plants responded well both to irrigation and fertilizer, but best to a combination of those two factors. The average plants in plot 4 are 126% bigger than the plants in plot one, the plants in plot 6 are 200% bigger. The demonstration of urine fertilizer efficiency can hardly be displayed more obviously, and farmers could very easily augment their harvest with this cheap and balanced fertilizer.

### 8.4.3 Oats



**Photo 34: Individual oat plants**

Individual oat plants after ten weeks of growth. The fertilization was carried out according to the scheme described above. Different growth heights are both due to fertilization and irrigation.

Similar results were achieved for oats (Table 3). A large difference is visible between the first and the second plot, which is an indicator that irrigation was crucial in this climate (although it has to be noted that summer 2007 was rather dry). This is also supported by the fact that the plants in column 3, which were not irrigated, were smaller than the plants in plot 4, although they received the same amount of fertilizer. Fertilisation clearly influenced the colour of the oats, with the plants getting darker the more fertilizer they received. Those two columns where the plants received a high rate of urine also showed the highest growth.

Column 4 of the following table highlights the height differences of the average plants in the individual plots. Plants in plot 6 were on average almost 50% bigger than the plants in plot one. But as the large difference between the plants in plot one (without anything) and two (only irrigation) shows, it was not only the fertilizer which had an effect on the height, but also the irrigation. The fertilizer effect was more clearly visible in the colour differences – the plants in columns 5 and 6 were distinctly darker than the plants in plot 1 or 2.

Oats						
No.	Fertilization and Irrigation	Height	Avg. Height % of plot 1	Colour	Plot condition	Other remarks
			August 14 <sup>th</sup>			no blossoms at all
1	no urine, not irrigated	mostly 25 – 40 cm, maximally 40 cm	32.5 cm 100%	light green	quite a few stones	very limited growth, few & brown leaves
2	no urine, irrigated	mostly 40 – 55 cm, maximally 60 cm	47.5 cm 146%	light green	some stones	
3	urine rate a (low), not irrigated	mostly 30 – 50 cm, maximally 60 cm	40 cm 123%	green	some stones	less biomass than 4, smaller than 2
4	urine rate a (low), irrigated	mostly 35 – 55 cm, maximally 60 cm	45 cm 138%	green	some stones	
5	urine rate b (high), not irrigated	mostly 40 – 60 cm, maximally 65 cm	50 cm 154%	dark green	some stones	actually higher than 6, biomass +/- equal
6	urine rate b (high), irrigated	mostly 45 – 55 cm, maximally 60 cm	50 cm 145%	dark green	some stones	

Table 3: Analysis of oat growth in different test plots

### 8.4.4 Natural Vegetation



Photo 35: Individual grasses

Individual grasses after ten weeks of growth. The fertilization was carried out according to the scheme described above. Different growth heights are both due to fertilization and irrigation.

The effects of fertilization and irrigation on the test plots with natural vegetation were more difficult to discern. There is a tendency that the plants grow bigger the more fertilizer they get, although the plot in the 5<sup>th</sup> column does not fit into this scheme. The effect of irrigation was clearly noticeable; the grass in the plots in column 2, 4 and 6 is consistently larger than in the comparable plots 1, 3 and 5 that were not irrigated. Fertilization seemed to result in more ramified grasses with slightly darker colours, but these subtleties were really hard to discern.

Column 4 in Table 4 highlights the height differences, which are slightly less distinct here than in the cases above. Plants get increasingly larger with irrigation and higher fertilizer amounts. Plants in the 6<sup>th</sup> plot were on average almost 50% bigger than the plants in plot 1.

Natural Vegetation						
No.	Fertilization and Irrigation	Height	Avg. Height % of plot 1	Colour	Plot condition	Other remarks
			August 14 <sup>th</sup>			no blossoms at all
1	no urine, not irrigated	Artemisia 30 – 50 cm, Grass 25 – 40 cm	36.25 cm 100%	mixed	not visible	
2	no urine, irrigated	Artemisia 30 – 45 cm, Grass 35 – 55 cm	41.25 cm 114%	mixed	not visible	dry, relatively little biomass
3	urine rate a (low), not irrigated	Artemisia ca. 40 cm, Grass 40 – 50 cm	43.3 cm 119%	mixed	not visible	relatively little biomass
4	urine rate a (low), irrigated	Artemisia 40(– 50) cm, Grass 35 – 45 cm	42.5 cm 117%	mixed	not visible	slightly more grass
5	urine rate b (high), not irrigated	All ca. 35 cm, 45 to 55 cm	45 cm 124%	mixed	not visible	lots of Artemisia, quite lush
6	urine rate b (high), irrigated	Artemisia up to 55 cm, Grass 50 – 55 cm	53.3 cm 147%	mixed	not visible	dense growth, mainly (bluish) grass

Table 4: Analysis of the growth of the natural vegetation in different test plots

In general, the trial garden clearly demonstrated the effects of urine fertilizer. There were significant differences not only in the height of the plants, but also growth density and in colour, which is most probably an indicator of the (possibly imbalanced) nutrient content of the soil. On the whole, the visitors were very impressed by the trial garden. One Mongolian lodge owner, who did not believe in reuse at the beginning of the author's stay in Khatgal, even had to contend at the end that he now saw that urine actually works as a fertilizer, and that he now thought it was possible to recycle the nutrients contained in human excreta.

For a detailed and scientific analysis of the trial garden, the study would have to be carried out with larger test plots and with a higher number of test plots in general, and it would have to include several growth periods. At the moment, there were too many external factors which may have influenced the growth of the individual plants, above all, the dry climate in summer 2007. Furthermore, the soil characteristics varied at a very small scale: in some plots, there were considerably more stones than in others; this should be acknowledged in future research.

## **8.5 Intermediate Conclusion**

Concluding, the acceptance of new sanitation technologies was larger than could be estimated from the framework conditions (low to no pollution of the lake, more or less functioning wastewater management systems). The user groups involved in the study all showed a substantial concern for the environment, and were generally willing to change their current behaviour to protect Lake Khuvsgul from pollution. Nevertheless, it became visible that each user group is putting the blame for pollution on another party: the lodge owners think that the campsites are the major source of pollution, tourists believe that lodges would not take their responsibility towards the environment and the polluter-pays principle serious enough, and the local people assume that the main source of pollution comes from the lodges. Yet, all user groups showed a substantial interest in new sanitation technologies: Lodge owners mainly for economic reasons, tourists because they greeted technologies which lessen the impact on the environment, and local people because they support the introduction of simple and feasible technologies to tackle lodges' and their own sanitation problems. All groups share a concern about potential pollution of the lake if current practices prevail, and if the pressure on this fragile area through increases through a higher influx of tourists.

## 9 SYNTHESIS

Ecosan is generally a feasible solution for Khatgal, in particular for tourist lodges. It is well accepted by lodge owners, tourists, and local people. However, there are certain limitations and unresolved points of discussion that have to be taken into account.

### 9.1 Discussion

The pilot project in the Khuvsgul Inn and the research carried out with lodge owners, tourists, and the local population in Khatgal revealed that ecosan could be a well adapted, sustainable solution for wastewater management in Khatgal. The following factors are crucial to the core question: “In how far could ecosan be a suitable alternative to conventional wastewater management in the Khatgal area, and what particular characteristics and features would have to be considered in order to adapt ecosan to the specific socio-cultural and nature-spatial framework conditions?”

#### 9.1.1 Natural Framework Conditions

Natural conditions favour the implementation of decentralised sanitation concepts in Mongolia. In the Khuvsgul region, the construction of conventional wastewater management infrastructure is limited by high groundwater tables, permafrost, and an extremely continental climate where temperatures lie below zero for almost nine months of the year. This makes it almost impossible to build underground structures such as pipes; furthermore, conventional wastewater treatment methods relying on biological activity generally have a very low efficiency at such low temperatures. Similar limitations apply all over in Mongolia. In addition, widespread water scarcity should actually prohibit the construction of sewer based sanitation (see also chapter 3.3 on the rationale for ecosan in Mongolia).

More sophisticated methods within the framework of ecosan could potentially be applied in cities (such as liquid composting, an exothermic aerobic treatment of wastewater), but are, due to their high costs and technical complexity, not feasible in scarcely populated areas. Biogas, another treatment option (anaerobic treatment of wastewater through bacteria, endothermic), is not feasible due to the low temperature level. Composting toilets would be another option, but also these work better in warmer regions. UDD toilets are thus probably the simplest, most economic and convenient treatment option available; they can easily be adapted to the continental climate. The dry climate speeds up the dehydration and hygienisation, and no expensive technical equipment is needed. The hygienisation can either take place in situ, or can be semi-centralised. Other, more advanced options in more densely populated areas should be the focus of further research.

#### 9.1.2 Legal and Institutional Framework

A suitable legal framework is crucial for the implementation of ecosan. At the moment, ecosan toilets *with* reuse are not officially a lawful option in the Khuvsgul region<sup>31</sup>. An interview with hygiene inspectors from Muren showed that they are greatly concerned about

---

<sup>31</sup> The toilet in Khuvsgul Inn was officially approved by the National Park authorities and hygiene inspectors. However, the general reuse of sanitised urine and faeces is not yet part of an official standard.

the hygiene and proper implementation of ecosan concepts (NARANTSETSEG, TSERENPAAGMA & DAVASUREN 2007); not least because they lack information on these alternative systems for wastewater management. In order to make ecosan more widely applied, national standards and guidelines have to be established.

In addition, the roles and responsibilities in the field of sanitation are poorly defined. A large number of governmental and private institutions and organisations try to tackle the issue without proper coordination. In all institutions, there is generally a lack of skilled and trained staff, and knowledge on alternative sanitation solutions is mostly inexistent. These framework conditions inhibit the implementation of ecosan on a larger scale and should be tackled in the near future.

### **9.1.3 Social Acceptance**

#### ***Acceptance***

As has been shown, the acceptance of the ecosan concept as such was high. Lodge owners were particularly interested because the current system is perceived as an economic burden that is additionally environmentally unfriendly – though, concerning the second argument, it must be kept in mind that there is a difference between terming something actually environmentally unfriendly and acting against it. Tourists greeted the introduction of a technology that would minimise the impact of tourism on the fragile environment, and local people were happy to learn about simple and effective solutions both for lodges and for themselves that would prevent the pollution of the lake.

The fact that it is a core aspect of ecosan to prevent the pollution of the environment – the very basis of people's existence in rural areas – may aid the general acceptance of ecosan. In addition, Mongolians are in general a rather pragmatic people: centuries of living very independently in a harsh environment and in a place that is not overly fertile have taught people to deal wisely with resources at hand. Nevertheless, Mongolia has never been an agrarian society, and the concept of using fertilizer, let alone human excreta, is alien to Mongolians. The acceptance of ecosan nutrient recycling thus stands and falls with the reuse concept that is chosen.

#### ***Information and Participation***

The information of end users and their participation in decision making processes are crucial. In Khatgal, local people specifically wished to be involved in decision making processes and implementation of ecosan systems. The acceptance of ecosan will be inevitably greater if people – both lodge owners and local people – are allowed to make their own choices, based on a thorough understanding of their alternatives. Essentially, the acceptance of any new system or procedure is based on a mutual trust and a thorough comprehension of the ideas and processes behind this alternative, but is the more important for systems that deal with tabooed subjects. In the end, the end users can be very good multipliers for new technologies, but only in a positive sense if they understand the new system and are fully convinced by it.

## 9.1.4 Operation and Maintenance

### Organisation

The mode of operation of ecosan toilets is perhaps the most critical factor for the success of ecosan in the Khatgal area in particular, and in Mongolia in general. As has been shown, the acceptance of the reuse-based ecosan concept as such is sufficient for the implementation of this alternative for wastewater management, but the surplus of maintenance work is considered a disadvantage. It is likely to keep some people from changing to ecosan systems.

If compared to a family pit toilet, it is clear that an ecosan UDD toilet requires more work. However, it must be considered that this toilet is a one-time installation. Pit toilets have to be replaced every few years. This is hard work in areas with a high groundwater table, rocky soil, or permafrost – all of which conditions apply in Khatgal. With ecosan, this work would be eliminated and replaced by the less exhausting, but more frequent emptying of reuse containers and storage compartments.

The case looks quite different for lodges, where the current system requires a lot of maintenance (frequent emptying of blackwater holding containers, see 7.1.3). Given that lodges would install a urine tank with a substantial volume, along with an on site greywater treatment system, the maintenance (especially emptying) and cost could be cut down enormously. The workload for ecosan toilets depends heavily on whether private management of ecosan toilets is chosen, or whether a professional service provider is hired.

Table 5 discusses the advantages and disadvantages of these two options for lodges and local people.

Private Management	
Advantages	Disadvantages
<ul style="list-style-type: none"> <li>Private management would have the advantage that lodge owners are truly more independent from any outside management, and the economic gain could be even larger.</li> </ul>	<ul style="list-style-type: none"> <li>It is not sure whether a sufficiently high level of safety can be reached with private management, especially if the value of the end product (fertilizer, soil conditioner), is limited in the absence of an established agricultural or horticultural tradition. If the direct benefits of the fertilizer are not tangible, it is likely that the handling and reuse process will be done in a rather lax manner, consequently constituting a risk for those involved, and eventually a risk of environmental pollution.</li> </ul>
<ul style="list-style-type: none"> <li>Private management is more cost efficient and thus affordable both for households and small guesthouses.</li> </ul>	<ul style="list-style-type: none"> <li>The private management of ecosan toilets may deter lodges from installing an ecosan toilet, as they believe they do not have the time and the resources to properly manage such a toilet.</li> </ul>
<ul style="list-style-type: none"> <li>In permanent settlements, it is now and then seen that people plant cabbage or potatoes in their compound areas (SCHENK 2006: 175). The private reuse of urine (the reuse of faeces will most likely not be accepted) could increase amount and quality of the harvest. This could, especially in poor ger areas, contribute to the food security on a family or neighbourhood basis.</li> </ul>	<ul style="list-style-type: none"> <li>Local people may find it too time consuming to maintain an ecosan toilet, as their benefits from the fertilizer are limited where agriculture is not common.</li> </ul>

<ul style="list-style-type: none"> <li>• The proper and hygienic reuse of nutrients on a private level requires the careful and long-term monitoring and counselling of the participating family/lodge in order to make sure that hygiene guidelines are applied and that no risk results from the reuse.</li> </ul>	
--	--

<b>Professional Service Provider</b>	
<b>Advantages</b>	<b>Disadvantages</b>
<ul style="list-style-type: none"> <li>• Professional servicing would increase the acceptance of those local people and lodge owners who are averse to ecosan because of the surplus in maintenance work</li> </ul>	<ul style="list-style-type: none"> <li>• The establishment of a professional service provider is probably very difficult. A whole new organisation or company would have to be established. Though there are certainly benefits from reusing ecosan fertilizer, potential investors may be reluctant because they doubt the acceptance of products fertilized with human excreta</li> </ul>
<ul style="list-style-type: none"> <li>• Professional servicing could improve the safety of the system by preventing lodges and/or families from dumping insufficiently treated excreta improperly.</li> </ul>	<ul style="list-style-type: none"> <li>• With a professional service provider, the often mentioned advantage that lodges would be more independent in their management, is to a certain extent invalidated (though fewer transports would be necessary with source separation and without flush toilets).</li> </ul>
<ul style="list-style-type: none"> <li>• Professional servicing makes sure that excreta are managed in a safe, hygienic and professional manner, so that a high quality end product is generated.</li> </ul>	<ul style="list-style-type: none"> <li>• A professional service provider may be too expensive for local families and small guesthouses.</li> </ul>
<ul style="list-style-type: none"> <li>• The amount of fertilizer produced by one lodge or one family may be too large to be applied within the compounds of lodges or family homes. A professional service provider could make sure that all nutrients are reused in the proper dosage.</li> </ul>	<ul style="list-style-type: none"> <li>• If the service provider is again dependent on (e.g. hired by) the currently mal-functioning administrative management structures, and is paid independent of his services, there is a high risk that those illegal practices that prevail today (illegal dumping) are continued.</li> </ul>
<ul style="list-style-type: none"> <li>• Professional management would make sure that the emptying and reuse of the ecosan fertilizer is done in a competent, safe and sustainable manner with the lowest possible risks for humans and environment. This would open up new business opportunities in transport, hygienisation, reuse and sale of fertilized products, and could thus strengthen the local economy and create jobs.</li> </ul>	<ul style="list-style-type: none"> <li>•</li> </ul>
<ul style="list-style-type: none"> <li>• A profitably operating company is probably the best incentive to provide high quality and reliable services to all parties involved</li> </ul>	<ul style="list-style-type: none"> <li>•</li> </ul>

**Table 5: Advantages and disadvantages of professional and private management of ecosan toilets**

### **Waste Flows**

For lodges, ecosan systems in the Khatgal area will only prove successful if greywater treatment systems are implemented at the same time. Greywater constitutes the largest part of the wastewater. By not producing blackwater from toilets, the reduction of the total amount of wastewater will only be partial. Without the inclusion of in situ greywater treatment, the

system will not be changed sufficiently to reduce the number of waste transport considerably and to motivate lodge owners to switch to ecosan from a cost perspective. Simple gravel filters or planted wetlands are relatively easy to install, and have a high efficiency also in cold climates; in any case, most water will accrue during the summer. According to JENSSEN (2007), the interruption of the water flow in the winter should not pose a problem for the functioning of simple greywater systems.

Greywater treatment for families is of secondary importance at the moment. In the absence of piped water supply, the amount of greywater is very small, and its infiltration through the soil or in soak-pits should not pose a hygienic risk, as private homes are all located quite far from the lake. However, the practice of infiltrating greywater in pit latrines should be strongly discouraged by local authorities, as it leads to a faster infiltration of pathogens.

### ***Prevention of Pollution***

At the moment, the water quality in Lake Khuvsgul is still very good. However, as research by B. OYUNMUNKH (2008) shows, first negative impacts are visible, especially close to lodges on the western shoreline of the lake. With the current flush sanitation systems, it can be assumed that the more pollution will result from lodges that are located very close to the lake in the future.

By proposing a dry system, ecosan (UDD toilets) could prevent the leakage of wastewater into the lake. However, it must be made absolutely sure that the application of the concept is sound and according to the standards. Just as the improper management of conventional sanitation approaches can the improper and careless operation of ecosan toilets lead to a deterioration of the environmental situation. It is crucial that those who operate an ecosan toilet – be it lodge owners, local people, or professional service providers – have a well-founded knowledge on the proper handling and maintenance of the excreta.

## **9.1.5 Economic Factors**

### ***Construction Costs***

Costs are another central factor that is crucial for the successful and broad implementation of ecosan. The (supposedly) higher costs for an ecosan toilet are an important aspect influencing the decision for or against ecosan.

Especially among **local people**, it was an often heard argument that ecosan was more expensive than conventional sanitation. Apart from the fact that a UDD toilet as built in Khuvsgul Inn offers a much higher user comfort and health benefits, a well designed, simple UDD toilet does not have to be that much more expensive than a pit latrine. As stated, a simple pit latrine for families with a pit the size of 2x2x3 m can be locally built for about 100'000 MNT, without costs for labour. A very basic, one-vault UDD toilet, would cost about 50% more, i.e. 150'000, if the seat is constructed locally (see Photo 36), and if the labour done by the owners themselves (BAYANJARGAL 2007). This is because slightly more wood is needed for a UDD toilet to construct the storage compartments. If a pre-fabricated seat is installed, the total costs depend very much on the seat. Plastic-moulded urine separating seats could probably be manufactured in Ulaanbaatar for about 40'000 to 70'000 MNT at the





Photos: K. CONRADIN

**Photo 36: Locally made urine-diversion toilet**

One family in Khatgal was so impressed by the ecosan concept that they started to build an own ecosan toilet at once. They displayed amazing skills in fabricating an own model of a urine diverting seat by taking an old tree trunk and fitting it with metal sheets and a funnel.

possible if local families are the target group. Though sanitation is regarded as an important issue, most families will not be able or willing to pay much more for an environmentally friendly toilet.

The case is of course different for **lodges**. The present model at the Khuvsgul Inn cost about 1.2 Mio. MNT (see chapter 6.2). Considering that the more upmarket ger camps spend significant amounts each season (some lodges spend up to 2.5 Mio. MNT) for the transport of the wastewater, an ecosan toilet could prove economically very attractive. Furthermore, tourists seem to be willing to pay slightly more for staying in a lodge that uses environmentally friendly technology. This argument is especially important if a concerted effort to change to ecosan would be made: then, all lodges could slightly increase their rates, and nobody would be disadvantaged due to higher prices. Thus, the costs of an ecosan toilet should definitely rather be an incentive than a deterrent for lodges. The investment costs could be amortised within a very reasonable time.

**Maintenance Costs**

If a system is not maintained by the users themselves, costs for the services provider arise. When talking about costs of ecosan systems in semi centralised systems, there are three ways in which the external costs of wastewater management can be internalised. These approaches depend essentially on the value and profitability of fertilizer in a given society, according to the law of supply and demand:

- If there is a very high demand for fertilizer in a given society, the actual producers of raw fertilizer (i.e., families) are paid for giving their excreta to a central service provider, who, in his turn, can sell the hygienised product (compost, urine) directly, or can make profit by using the soil conditioner himself. This is essentially the narrowest interpretation of the ecosan thought which truly implements the basic premise that excreta are a resource.

moment, but it is assumed that their price could be cut down significantly with a higher production rate (ARIUNBOLD 2007). The cost of storage containers must be added to the total cost. However, if it is considered that a pit latrine has to be replaced after a few years, the difference between these two options is relatively small. Nevertheless, the cost factor is crucial for local families, and it is absolutely essential to keep the cost for prefabricated parts (seats, urinals) as low as

- If the demand for fertilizer is moderate to high, the service provider could remove the raw product for free; the consumers (lodge owners, families) “pay” the service provider for the removal of the excreta with their raw product, and the service provider can still make profit from selling a processed and hygienic end product or reusing it himself and selling fertilized produce.
- If the value of the fertilizer is relatively low, and a service provider cannot expect to make large benefits from the sale of the sanitised fertilizer or from the production of produce with ecosan fertilizer, it is likely that the consumers have to pay for the service of removing excreta. The income of the service provider is constituted by these fees and by the sale of fertilizer and/or produce.

Which model is chosen is in the end the business decision of the service provider itself. It depends on how much profit can be made from the reuse of the ecosan fertilizer, but also from the existence of additional financing schemes. In any case, it must be made sure that centralised solutions are affordable for all user groups, including low income families.

### **9.1.6 Sustainability of Reuse Concepts**

The acceptance of reuse concepts is probably the most crucial factor for the success of any ecosan concept, even more so within a non-agrarian society. In addition to being socially accepted, the chosen reuse concepts should be adapted to the environment and economically profitable in order to be truly sustainable. The different proposed reuse concept shall here – very briefly – be analysed from the point of view of sustainability, not only for Khatgal, but also for other regions within Mongolia.

#### ***Silviculture and Reforestation***

Reforestation and silviculture enjoy the largest acceptance by all user groups. In the Khatgal area, they are also among the most environmentally adapted solutions, as agriculture is only possible to a very limited extent due to climatic reasons.

Large parts of the forests in the immediate surroundings of the village have been cut down in the last decades. As a consequence, Khatgal faces much stronger winds and more frequent dust storms. The existing forests show severe signs of overuse: all dead wood is collected by local families to supply their needs, and there are hardly any young trees. The resulting microclimate is unsuitable for young seedlings to grow (too much wind, lower humidity). The surroundings of Khatgal are intensively used by livestock, further preventing re-growth of young trees. Two strategies would be possible: to actively reforest the logged areas, or to plant trees in a plantation to decrease the exploitation of natural forests. This option could of course also be economically interesting. When regarding the whole of Mongolia, it has to be considered that there is a substantial need for wood in Mongolia, but large forests grow only in the northern provinces, due to the limited precipitation in most other areas. The planting of trees is thus geographically quite limited. Irrigation is always critical (in terms of salinisation and waste of water through evaporation) and should be done in a very considerate way only.

Further thought has to be given to the tree species chosen: Naturally, the forests around Khatgal are made up almost exclusively by larches; a few willows grow along riverbeds, and aspen, birch and pine occur from time to time. Larches naturally do not have a very high

nutrient demand and are hence maybe not the most suitable plant for a nutrient-reuse concept. Willows, for instance, have a higher demand in nutrients, but also have a high water demand on the other hand. Which species is planted in the end should be carefully evaluated, according to the local ecosystem conditions.

When planting trees and considering the reuse of excreta for fertilizer, trees should be planted in shallow pits. This does not only help to keep the moisture, but would also facilitate the application of frozen fertilizer that thaws in the spring (see 8.3.5).

### **Berries and Sea Buckthorn**

Mongolia is among the three largest producers of sea buckthorn (*Hippophae Rhamnoides*) commodities. The plant is well adapted to the Mongolian environment because it is resistant to drought and tolerates soil salinity and low temperatures down to  $-45^{\circ}\text{C}$  (SMALL, CATLING & LI 2002). Sea buckthorn grows best in areas with 300 to 400 mm annual precipitation. Riverbanks, lakeshores, steep slopes, and other susceptible terrain can benefit from the establishment of sea buckthorn. Sea buckthorn is a nitrogen fixing plant that rapidly develops an extensive root system; it is therefore suitable for preventing soil erosion and land reclamation, and can help to prevent desertification (LI 1999: 335). Its wood can also be used as firewood, and the plant could potentially be used for the green wall project in the Gobi Area and Inner Mongolia<sup>32</sup>. Sea buckthorn is promising economically, since its berries are highly nutritious and the juice and seed oil have medical qualities.



Photo: R. TUOMAINEN

#### **Photo 37: Sea Buckthorn (*Hippophae Rhamnoides*)**

Sea buckthorn is a winter hardy, deciduous shrub with yellow or orange berries. It grows in Central Asia, Europe, and North America. It develops best in areas with an annual precipitation of 300 to 400 mm, and is resistant to the extreme cold.

compounds and phosphorus) or ash fertilizer. It would, due to its own nitrogen-fixing abilities, respond less to urine, as nitrogen fertilization can adversely affect root nodulation (LI 1999: 336). However, further practical research would be necessary to prove this.

Due to the abovementioned qualities and its high acceptance among all user groups, sea buckthorn would be a well adapted crop to facilitate a balanced reuse of ecosan fertilizer in Mongolia. The plants require adequate soil nutrients for a high yield of good quality fruits.

It responds well to phosphorus fertilizer, and compost and manure are frequently used as a fertilizer in commercial plantations. Best growth occurs in deep, well drained, sandy loam with ample organic matter (THOMAS & MCLOUGHLIN 1997: 4). Sea buckthorn could potentially be a plant to reuse dried and composted fertilizer from faeces (high in organic

<sup>32</sup> In hopes of preventing desertification and minimizing the impact of dust storms coming from Central Asia, a "wall" of thousands of tree and shrub saplings is planted in Inner Mongolia and the Gobi area. While the project is deemed a success by some scientists, others criticise that the project does not address the roots of the problems – exploitation and overpopulation – and would put an additional stress on the already scarce water reservoirs in the area.

### ***Agriculture and Animal Forage***

Due to its low acceptance and climatic unsuitability, the reuse of ecosan fertilizer in agriculture would not be a sustainable option in the Khatgal area. From an ecological and economical point of view, it could, however, be a realistic option in those areas of Mongolia where agriculture is already practised (mainly Bulgan and Selenge aimags). Furthermore, the production of animal forage would surely lessen the pressure on the natural vegetation and could be an additional measure to decrease soil degradation and desertification in those areas – but in any case, the limited suitability of many areas in Mongolia for arable farming (see also 3.3.2) has to be respected. Nevertheless, according to Mr. Enkhtuvshin, head of the Mongolian Organic Farmer's Association and Professor at the Agricultural University of Mongolia, the Mongolian government encourages small scale farming to lessen its dependence on food imports from China and Russia (ENKHTUVSHIN 2007). It is also a fact that Mongolia imports several thousand tons of fertilizer (FAO 2004: 1, Internet) which could potentially be substituted by ecosan fertilizer. This could be an economic incentive for farmers: cheap fertilizer imports from Russia are no longer available; fertilizer is bound to the world market price and the prices are increasing every year. According to Mr. Enkhtuvshin, fertilizer is commonly used in the Selenge and Bulgan aimags, where farmers also produce additional fodder for their livestock on dairy and meat farms. Although it cannot be concluded from this study whether the use of ecosan fertilizer in agriculture would be a culturally acceptable solution for local farmers, Mr. Enkhtuvshin argues the farmers in these provinces would be very eager to learn about new methods that could improve their yields (ENKHTUVSHIN 2007).

Not only the results from the trial garden (see 8.4), but also international research prove the effectiveness of urine fertilizer. In field experiments in Sweden, “barley yields in plots fertilized with human urine amounted to about 80 to 90% of those in plots fertilized with mineral fertilizer following normal nutrient doses for a spring barley crop” (JOHANSSON ET. AL. 2000: 26). Urine fertilizer is thus about as effective as artificial fertilizer. Faeces could additionally improve the soil structure of the agricultural area.

### ***Vegetable Production***

Taking the lodge owners' position, where the acceptance of vegetables is relatively good, it would make sense in the Khatgal area to decrease the energy intensive vegetable imports by plane from Ulaanbaatar (mostly imported Chinese vegetables). While urine could be a suitable fertilizer for vegetables, due to its generally low risks of disease transmission, the use of sanitised faeces for vegetables should rather be discouraged in this specific setting. In order to be able to reuse ecosan fertilizer on vegetables, a very high quality fertilizer with the lowest possible



Photo: K. Conradin

#### **Photo 38: Farmland in Selenge aimag**

Arable farming is not practised in many parts of Mongolia, but certain aimags such as Bulgan, Selenge and Kenthii in the north offer suitable conditions

pathogen count would be needed. A secondary treatment of the dried faeces would be essential, and it remains doubtful whether such a high quality could be produced by individual lodges or families. Besides, vegetables that can be produced in the Khatgal area include mainly root crops, which carry an inherently higher risk of disease transmission as they are in direct contact with the soil. However, one very suitable alternative could be cabbage, which needs high amounts of nitrogen fertilizer; and research has shown that cabbage responds just as well to urine fertilizer as to artificial fertilizer, with no differences in taste (COLWELL 2007, Internet).

Despite its rather low acceptance among local people, vegetable production could prove economically interesting for small scale farmers in Khatgal during the summer, considering the relatively high demand by tourists. The range of vegetables sold in the local stores is usually very low and includes at best potatoes, cabbage, carrots, onions and turnip and a few cucumbers in summer, but most of the time, only potatoes and onions are available. A higher variety in vegetables would not only benefit the local nutrition, but could also offer income generating possibilities for the local population during the summer months when there are many tourists who generally consume more vegetables. However, reasonable harvests are mainly reached in greenhouses, which is an impediment for this reuse option. Even though vegetable production with urine for the consumption of tourists could be a way to generate additional income (possibly with the creation of a label) for the local population, it remains doubtful whether such an approach would be accepted on a larger scale.

Other areas in Mongolia would be well suited for small scale vegetable farming, but the same hygienic limitations apply. Furthermore, the production of vegetables is often only possible with irrigation, which could put additional strain on the limited water sources.

Concluding, it can be stated that vegetables would be a sensible reuse option to diversify income possibilities and perhaps to improve the local population's nutritional situation. However, the production of vegetables with ecosan fertilizer is not well accepted by the Mongolian population, and will – maybe apart from professionally managed projects that produce food not for their own consumption – most likely not prove very successful in the short run.

### ***Burning and Burying of Sanitised Faeces***

Burning and burying of sanitised faeces are not actually reuse options, and preference should be given to options which facilitate the reuse. However, these options shall shortly be discussed here as they were often raised in the discussions with lodge owners and local people, and would be well accepted solutions.

**Incineration** will minimize the risk for transmission of diseases since essentially all pathogens will be removed. The ash can be reused and is still a potent fertilizer with phosphorus and potassium retained, but large parts of the nitrogen and sulphur will be lost, and organic matter is degraded (JÖNSSON ET AL. 2004: 13). Especially the last point is an argument against burning, as organic matter is crucial for the amelioration of the soil structure and its moisture retention potential; crucial factors for soils in Mongolia (as described in 3.3.1).

While other options that make use of the nutrients contained in human excreta should be given preference, burning could be an option in areas where there is really no possibility in reusing the nutrients, or where the acceptance of ecosan toilets could be significantly raised by this technology. The latter could be the case in Khatgal, where many local people and lodge owners came up with this option by themselves. Of course, this attitude is also based on the fact that excreta are waste, and that this waste needs to be eliminated somehow – a mindset that the ecosan approach actually tries to alter. Nevertheless, it can be argued that the implementation of ecosan toilets with an incomplete reuse of nutrients is still a significant improvement of the current situation with conventional pit latrines which do both not make use of any nutrients and pose a risk for water pollution. In the specific case of sea buckthorn, ash could even prove a more effective fertilizer than dehydrated faeces. Ash contains less nitrogen, to which sea buckthorn generally does not respond too well, but still high amounts of phosphorus, which is very important for the plant's root formation.

Similar arguments can be brought forward for **burying sanitised faeces**. While the benefits that result from reuse will be lost (including economic benefits), implementing ecosan toilets still causes a significant improvement of the hygienic situation. Notwithstanding this, care has to be taken that the faeces that are buried are actually properly hygienised. Otherwise, the whole system will not be a large improvement from conventional pit toilets. In any case, other options are preferable.

### **Other Reuse Possibilities**

In interviews with various experts, other Mongolia-specific reuse options that were not discussed with the local population of Khatgal or with lodge owners were brought forward. Some of these options seem very promising in Mongolia and shall be briefly illuminated:

- Mining is an important economic factor in Mongolia: in 2000, 40.5% of its foreign earning came from the mining sector (WHEELER in BLUNDEN 2004: 47). According to Mongolian law, the **mining sites need to be restored** after their exploitation is completed. Though the topsoil should be removed and set aside when mines are opened, this is hardly ever done in practice. Accordingly, the restoration of mining sites is usually limited to technical recreation, i.e., the closing of holes and caverns. According to Mr. Baatarbileg, president of the Mongolian Mining Recreation Association (an Ulaanbaatar based NGO), compost from ecosan toilets could be a great resource to facilitate that ex-mining sites can be re-planted again (BAATARBILEG 2007). The need for compost from ecosan toilets would be almost infinite (which would of course require the installation of ecosan toilets in large numbers, or in large institutions). It is to be expected that there are low acceptance barriers with such a kind of reuse, as no food crops will be grown on these areas later on. Still, the reuse of good-quality compost could facilitate the re-growth of vegetation on abandoned mining sites and could help in restoring local ecosystems.<sup>33</sup>
- Likewise, ecosan fertilizer from faeces could also be used for the establishing of **recreational sites in urban areas**. Similar to the laws for mining companies,

<sup>33</sup> From an agricultural perspective, it would of course be better to bring the fertilizer aback to the areas where it has been removed from the soil. All the same, this chapter tries to show reuse possibilities that might facilitate a higher acceptance of ecosan and the reuse of nutrients in a non-agrarian society.

construction companies that build large projects in urban areas have an obligation to create some recreational areas to compensate the loss of green areas. The construction of parks or flower beds requires substantial amounts of good quality soil, which is often not available in urban areas. Composted and sanitised faeces could be used to improve the quality of inner urban lives by providing an important soil conditioner and fertilizer for urban green areas (BAATARBILEG 2007, ENKHTUVSHIN 2007). An advantage of this solution could be that the fertilizer is actually needed in cities, were it is produced in the largest quantities and would not have to be transported far.

## 9.2 Conclusion

In response to the core questions posed in chapter 1.3, the following conclusions can be drawn:

### (1) What is the different user groups' (lodge owners, local population and tourists) respective attitude towards ecosan systems?

In spite of their rather bad reputation, **lodge owners** are generally well aware of existing environmental problems. They have a significant interest for new ecological sanitation solutions. The reasons to switch to a more ecological and sustainable alternative are not necessarily rooted in a care for the environment, but rather because they wish for solutions that are more cost effective. The current system is perceived by many as an environmentally non-friendly technology that additionally constitutes a significant financial burden for lodges, especially smaller ones.

The biggest advantages in the lodge owners' perspective are that ecosan is economically more attractive than the current system, that it would enable lodges to be less dependent on the communal management (if greywater management systems are implemented at the same time), and that it could be used year round. The largest drawbacks are that ecosan is perceived to be more labour intensive, and that the new concept could actually lead to a deterioration of the environmental situation if it is not applied properly.

A significant number of lodges showed a genuine interest to switch to ecosan toilets. However, this will not be possible before ecosan is not officially accepted and made into a standard by the environmental and hygiene inspectors. Though some lodge owners were willing to carry out all maintenance aspects themselves, the system would probably enjoy a greater acceptance if the reuse would be organised centrally for a competitive price.

Though not all **tourists** are aware of problems and difficulties related to sanitation, they are concerned about the impact of tourism in general and current wastewater management in particular. They wish for more sustainable solutions, better management and stricter regulations. All in all, tourists' acceptance of ecosan as an alternative to the current practices in wastewater management is very high. The majority of tourists stated that they were willing to support lodges' endeavours in providing more environmentally friendly services and infrastructure by putting up with slightly higher prices for accommodation. The respondents view ecosan as a good solution and a practice that should be employed more, especially within National Parks in Mongolia. They see many advantages of the ecosan toilets, most importantly, the protection of the environment and the prevention of pollution along with the

beneficial effects of compost. Yet, they also recognize some drawbacks, such as the need for education and the plus in maintenance work for ecosan toilets. The acceptance of products fertilized with sanitised excreta is unexpectedly high: almost all tourists view such products positively, as long as the proper guidelines are followed. They think that reuse and production of wood, berries, or vegetables in greenhouses could prove to be an additional source of income for local people.

The study with **local people** of Khatgal showed that solid waste and sanitation issues constitute the most prominent concerns, whereby sanitation issues of lodges and campsites are perceived to be more important than their own problems. Generally, local people showed a high interest in alternatives, though it must be kept in mind that for them, sanitation is only of second importance. A crucial reason for their support is that conventional pit latrines are difficult to build under the current conditions with high groundwater tables and permafrost. The main advantages were considered to be hygienic improvements and the prevention of pollution, an improvement in management of the lodge owners' sanitation system, increased user comfort, and the tackling of current construction problems. The most limiting factors for the acceptance of ecosan are on the one hand the higher cost of ecosan toilets, and on the other hand the maintenance work, especially concerning reuse. If the reuse would be organised centrally, ecosan would enjoy a very high acceptance, though few could contribute to this financially. Further improvements and adaptations in the design are necessary to make the ecosan system useable in winter.

**(2) Which options are most suitable – socio-culturally, ecologically and economically – to facilitate the reuse of nutrients contained in human excreta?**

As was expected, those reuse concepts that involved non-food crops enjoyed the highest acceptance among all user groups. Considering the high consumption of wood in Mongolia, and the high speed of deforestation – the forest area has decreased from about 14 Mio. ha in the early 1990s to little over 8 ha in 2005 (MARRIOT 2005a: 23) – the use of fertilizer or compost in tree plantations would be a sensible option, especially in areas where there is enough precipitation. The production of animal fodder was not regarded as an appropriate option in the Khatgal area, due to the climatic conditions that severely limit agricultural activities. Furthermore, local people get enough fodder from surrounding meadows. It could, however, be an option in those areas in Mongolia, where agriculture is more common. Generally, also fruit trees or berries (sea buckthorn) were very well accepted in the Khatgal area, as the berries are not in contact with the soil or fertilizer. Vegetables were not well accepted by the local people, but some lodge owners view it as a feasible option. It remains to be clarified whether it would for instance be an alternative for lodges to buy locally grown produce for their restaurants. Local people then could further profit from tourism by growing produce with ecosan fertilizer, possibly with an own label. However, a very high quality fertilizer would be needed for this, and it remains doubtful whether this can be achieved locally.



**(3) What do lodge owners and local people perceive as environmental problems, specifically in relation to water and sanitation?**

Lake Khuvsgul is clearly at the centre of every environmental concern, both of local people and of lodge owners. Local people perceive the lacking solid waste management (including the central dump) and the non-adherence to sanitation standards of lodges to be the biggest problems, though they assert that also their pit toilets and waste dumps pose a potential threat to the lake. They feel that they are not sufficiently involved in decision making processes and that they lack the knowledge on alternative solutions. The lake is of pivotal importance for them; it is the only water source they have.

Lodge owners perceive the lacking management of campsites, and the location of some of the lodges too close to the lake as the biggest environmental problems. They are afraid that leachate from campsite toilets, or from the wastewater holding containers/toilets of those lodges that are close to the shoreline may infiltrate the lake and pollute it. The management of solid waste from lodges is not perceived as a serious problem, as it is regularly removed from there. Nevertheless, they see a need to improve the central waste dump. Motivations for lodge owners to protect the lake have two reasons: On the one hand, the lake too constitutes the only water source for the lodges, but on the other hand, it is also the main reason for tourists to visit the area.

**(4) What are the effects of different amounts of urine fertilizer and water given to the test plots in the trial garden?**

As had been stated in the hypothesis, the plants that were fertilized reacted with increased growth; the combination of water and fertilizer proved to be most effective. The results from the trial garden are promising, and the main goal of demonstrating visitors the benefits of ecosan fertilizer was clearly reached. However, no final scientific conclusions concerning the effects of urine can be drawn from the experiments in the trial garden. For this, the test period is too short, and too many other factors could have influenced the growth of the plants (natural precipitation, temperature, soil conditions, etc.). For further information on this aspect, refer to VON ARX 2008.

**(5) In which way could ecosan contribute to a sustainable tourist development in the area?**

Ecosan could be a part of an array of combined efforts to make tourism in the Khuvsgul area more sustainable, if it is used properly and on a larger scale, and if the reuse concept is chosen sustainably. Accordingly, environmentally friendly sanitation options should be integrated into the concept and standards for eco-tourism. By implementing ecosan on a larger scale in the lodges around lake Khuvsgul, this area could become one of the first eco-tourism areas in Mongolia. The further pollution of the lake could be prevented rather than dealt with in hindsight. If reuse concepts are chosen in such a way that they are socially acceptable, the local population could establish further, ecologically friendly income possibilities; locals would thus be more closely linked to tourism and could benefit from it.

**(6) Is ecosan with its reuse based concept also feasible in non-agrarian societies?**

All in all, and as the discussion in chapter 9.1.6 shows, reuse-based ecosan concepts can also be implemented in non-agrarian societies. The reuse of nutrients is feasible, but it is crucial to design nutrient loops that are not too narrow. Concepts that involve non-food crops, or food crops that are not in direct contact with the fertilizer, or are processed, are more likely to be accepted. However, the introduction of ecosan with reuse will be more time consuming and will require more awareness raising, counselling and training than in societies where agriculture and fertilization with various conditioners is already practised.

With the necessary adjustments in the design of the toilet so that it can also be used in the extreme cold, and with a sensibly chosen, adapted and sustainable reuse concept, ecosan can be a socially acceptable, economic, and environmentally friendly solution to overcome the current problems with wastewater management in the Khuvsgul region.

**9.3 Recommendations**

Based on the results chapter and the discussion, a set of recommendation was developed. These recommendations can serve as a guideline to all those organisations and institutions that would like to implement ecosan solutions in Mongolia:

***General Recommendations***

- The **connection between environment, tourism and waste management** must be understood more clearly. In most areas in Mongolia, the pristine environment is the only basis for tourism. Tourists will fail to appear if the environment is polluted, i.e., if solid and liquid waste are not managed properly. Tourism should be an incentive for both lodge owners and local people to protect their environment. For a sustainable development of tourism in Mongolia, it is crucial that all those involved in the tourism business recognize this connection and implement it on a legal and real-life level, respectively. The concept of eco-tourism – for which Mongolia is a prime destination – should not remain a simple slogan, but must be filled with contents. The economical use of resources (in the sense of sanitation: water for flushing, gasoline for transportation) and the sustainable dealing with waste must in any case be implemented in this concept such as not to endanger the actual basis of tourism. This could set Mongolia aside from other tourist areas where nature is the prime attraction by proposing a truly sustainable tourism.
- Individual projects will only have a very local effect. For a larger influence, **concerted efforts** are needed. These depend to a large extent on whether the ecosan approach can be rooted in politics.

For any further ecosan project, it is thus necessary that a **clear regulatory framework** exists. It is essential to include those authorities who issue and actually put sanitation guidelines into practice, and who are in charge of the implementation of sanitation standards in educational programmes on alternative sanitation. Only then can the current legislations be changed, and can ecosan and the reuse of sanitised faeces become a legal or preferred sanitation option. Results from the tourist survey clearly

support these views: tourists actually call for the implementation of stricter rules and regulation, because they would like to protect this unspoiled nature from degradation through (too intensive) tourism. Mongolia is no mass-tourist destination yet; there would be time to implement stricter laws and prevent that this beautiful country is getting exploited by travellers, as can be seen in so many other tourist destinations.

- In order to support the creation of new local sanitation guidelines, an **unrestricted disclosure of research results** by all organisations working in this field, especially concerning the hygiene and safety of ecosan toilets under the given conditions, is necessary. Based on these results and international standards, local standards for ecological sanitation should be issued.
- The **reuse concept** must be chosen sensibly and in cooperation with all stakeholders. In particular in a non-agrarian society, the reuse factor is the most crucial aspect of the ecosan concept. In the best case, the reuse of ecosan fertilizer could be the starting point of a value-added chain, e.g. with organic wood or sea buckthorn products. This could create additional income possibilities.
- The organisation of the **maintenance of the ecosan toilets** and the reuse of the sanitised excreta is another crucial factor. In general, a centralised system will be more widely accepted, but is also more expensive. The private maintenance, on the other hand, is the most economical option, but requires careful instruction and ongoing counselling. In any case, it is important that the chosen solution is accepted by the end users.
- The **design** of the installed pilot project toilet is not completely fit for being used in the wintertime. More research is necessary to develop a toilet that is winterproof and had an affordable cost (see also 8.3.5, ecosan in winter). In particular, the freezing of pipes, the storage of urine in the wintertime, the build up of frozen excreta, the toilet insulation, the dewatering of excreta by freezing and thawing and the storage of urine must be considered.
- In dehydration toilets, **additives** are often added to the faeces. This practice is not absolutely necessary, but it also can aid the drying process, prevent that insects land directly on excreta, and can speed up hygienisation. In Khatgal, it was first proposed to use dried horse dung. It would suck up moisture and distribute it more evenly, and would raise the organic content; on the other hand, it further enlarges the volume in the collection chamber, and does not have an influence on hygienisation. In areas where wood ash is commonly available, this seems to be the better option. Ash increases the pH of the collected faeces and hence aids the sanitising process; furthermore, ash can be dosed more sparingly, so that the volume of the excreta is not unnecessarily increased.

#### ***Khatgal in Particular***

- The **current practice** of dealing with wastewater should be substituted by a more sustainable option. The transport of huge amounts of wastewater from tourist lodges on the road is very energy intensive and leads to degradation of the soils in the area. Moreover, it often results in illegal dumping due to the high costs of this system for

lodge owners. Though the collection of the wastewater in a place far away from the lake protects the lake as such, this study demonstrates that more cost efficient and environmentally friendly solutions exist, and should be embraced immediately. With such an approach, the pollution of Lake Khuvsgul could be prevented, instead of dealing with it in hindsight.

- In order to convince more lodge owners of the suitability of ecosan also for larger lodges, it would be good to implement more demonstration projects. In the best case, this could be a **fully-fledged eco-lodge** that can be used as a demonstration ground for various environmental technologies. Such a lodge could also be an importance practice example for those that are educated in eco-tourism (eco-tourism is actually a subject that is offered in Mongolian further education programmes).
- The implementation of ecosan on a larger scale in the Khatgal could promote a more **sustainable tourism** in the area. Hygiene and environmental inspectors, in cooperation with the National Park authorities should implement new sanitation standards that discontinue the currently environmentally damaging practice as soon as possible. In the Khatgal area, ecosan could even be made into the legally preferred option. Lodge owners clearly favour the installation of standards that are more economical, tourists evidently expressed their desire for more ecological options, and local people also supported the concept. The implementation of ecosan on a larger scale would not even be very expensive, as many lodges are ready to switch to ecosan on their own and would not need financial support. Due to the limited number of lodges in the area, it would be feasible to include the largest part of the lodge owners without excessive temporal or financial investment. Like this, the Khatgal region could become the first real eco-tourism area in Mongolia; and it would be distinct from other tourism areas with similar offerings. A sustainable ecosan concept with the involvement of all stakeholders could even become Khatgal's unique selling proposition.
- In accordance with the abovementioned argument, it is of pivotal importance that the reuse concept is well accepted and supported by all involved stakeholders. The **local reuse of ecosan fertilizer** produced in this area could close the nutrient loop and could link the local population closer to tourism, e.g. by means of a value-added chain with organic wood or sea buckthorn products. This could improve people's participation in the tourism business, which is also an important part of the sustainability of tourism. Interviews with local people show that they actually would like to be more involved in this economy, and tourists are usually happy to support local industries where they travel.
- In any case, the **involvement of lodge owners and the local population** in decision making processes is critical for the success of ecosan, as it is a solution that needs more involvement of the end user than conventional, waste-based sanitation does. If people opt for certain ecosan solutions, it is essential that they understand the purpose and benefits, but also the inherent risks and safety guidelines.

Concluding, ecosan has to be regarded holistically: it is not only a sanitation concept, but a paradigm that involves environmental, social, and economic factors. All aspects of ecosan – design, planning, maintenance, operation, and reuse – must be looked upon under the basic conditions of sustainability: they must be socially acceptable, economically viable and environmentally friendly. If this is done, ecosan could indeed prove as a very attractive solution to the wastewater management problems in Khatgal, and could additionally lead to an array of positive side effects.

## 10 SUMMARY

Mongolia is primarily known for its pristine nature and vast infinity: boundless steppes, endless blue skies, and crystal-clear lakes. Being the country with the lowest population density in the world, few people give environmental problems in Mongolia much thought. However, mining, an exploitative land use, urbanisation and a growing tourism industry have increasingly negative influences. In regard to the latter two points, the question of wastewater management is largely unsolved. Few people have yet given thought to alternatives to conventional wastewater systems, which are generally not suitable for Mongolia. This thesis thus focuses on assessing the acceptance of ecological sanitation – or ecosan, for short – as an alternative to conventional wastewater management by means of a pilot project in the Lake Khuvsgul region in northern Mongolia.

### **Context**

The sanitation situation in Mongolia is critical: only roughly a third of the population have access to adequate sanitation. The consequences are grave: due to seepage, the groundwater in urban areas is heavily polluted, and gastro-intestinal diseases kill hundreds of people every year. While it is clear that the high population density in urban areas coupled with inexistent sanitation infrastructure leads to environmental problems, rural areas are often neglected in such considerations. But also rural areas face problems. Tourism industry, though claiming to be ecological, is often everything else than environmentally conscious, and the question of wastewater management for tourist areas is largely unresolved. The polluter-pays principle is hardly ever implemented, and often, the local population has to bear the negative impacts of tourism: solid waste and water problems are common.

The framework conditions for providing adequate sanitation in Mongolia are, however, more difficult than in other countries. Natural conditions such as the extremely continental climate with temperatures below zero for the larger part of the year and permafrost make the construction of underground pipes impossible. A conventional wastewater treatment is inefficient at cold temperatures. Furthermore, water resources are very limited in most parts of the country, and flush sanitation should not be proposed due to the widespread water scarcity. The settlement patterns with few urban centres, and an otherwise very scarcely scattered population prevent the construction of a centralised infrastructure. Similarly, the rapid urban growth has made it impossible for governments to provide sanitary infrastructure at an adequate speed in densely populated areas. Given these conditions, it is clear that conventional, sewer-based and centralised wastewater systems are not the most adapted and adequate solution for Mongolia. Much more, decentralised and individually adaptable solutions, as they are available within the framework of ecological sanitation, are needed.

### **Ecosan**

Ecosan is a new paradigm in sanitation that moves away from the linear approach of conventional sanitation, where a small amount of excreta is allowed to pollute thousands of litres of water, where nutrients are wasted instead of reused, and where large amounts of energy are needed to clean water which would not have had to be polluted in the first place. Instead, ecosan regards excreta as something beneficial. What humans excrete still contains

many nutrients that are not available to their bodies, but are a perfect fertilizer for plants. However, excreta need to be hygienised before they can be reused. Thus, the basic principles of ecosan are separation, hygienisation and reuse. Separation is necessary because each fraction (urine, faeces, or only slightly polluted greywater from showers or sinks) can be treated best if they are pure, and because water should not be used as a means to transport wastes. After treatment, for which there are various methods, the sanitised excreta and greywater can be used in agriculture. The nutrients that eventually come from the soil are put back into the soil, and the loop is closed.

However, ecosan has so far been mostly applied as a low-tech option in tropical countries, while more sophisticated methods were applied in colder regions. Furthermore, ecosan with its reuse based approach has not been applied widely in areas where agriculture is not common. This study thus aimed at filling this gap by researching the acceptance of ecosan in northern Mongolia by means of a pilot project in Khatgal, the village at the southern end of Lake Khuvsgul.

### ***Pilot Project***

In summer 2007, a first UDD toilet was installed in Khuvsgul Inn in Khatgal to demonstrate alternative options for wastewater management, and to get away from the current, environmentally polluting practices. The pilot project consisted of a urine-diversion dehydration toilet that was located within the compound of Khuvsgul Inn. It comprised two cubicles. Urine was collected in 20 L containers, and then reused in a trial garden, where the effects of urine as a fertilizer were demonstrated to visitors (local people and tourists). Faeces were collected in two metal barrels. If a barrel is full, it is pushed to the back and left untouched until the faeces are completely dry. Faeces could not be reused this year, as there was no sufficiently long hygienisation period.

### **Current Sanitation Practices**

Currently, the wastewater management is organised as follows: Most upper-class ger camps have flush toilets, while cheaper guest houses generally have simple pit toilets. Lodges are obliged to collect their wastewater (both greywater and blackwater) in holding tanks. These holding tanks are regularly emptied by tanker trucks; the wastewater is then discharged untreated in an open dump some kilometres south of Khatgal. This practice is not only highly energy consuming, but is also very expensive for lodges

### ***Acceptance of Ecosan***

The acceptance of ecosan as an alternative to current wastewater management practices was researched by means of semi-structured interviews with lodge owners, a questionnaire for tourists, and community meetings with the local population during a time span of three months in summer 2007.

In spite of their rather bad reputation, **lodge owners** are generally well aware of existing environmental problems. They have a significant interest for new ecological sanitation solutions. The reasons to switch to a more ecological and sustainable alternative are not necessarily rooted in a care for the environment, but rather because they wish for solutions that are more cost effective. The current system is perceived by many as an environmentally

non-friendly technology that additionally constitutes a significant financial burden for, lodges, especially smaller ones.

The biggest advantages in the lodge owners' perspective are that ecosan is economically more attractive than the current system, that it would enable lodges to be less dependent on the communal management (if greywater management systems are implemented at the same time), and that it could be used year round. The largest drawbacks are that ecosan is perceived to be more labour intensive, and that the new concept could actually lead to a deterioration of the environmental situation if it is not applied properly.

A significant number of lodges showed a genuine interest to switch to ecosan toilets. However, this will not be possible before ecosan is not officially accepted and made into a standard by the environmental and hygiene inspectors. Though some lodge owners were willing to carry out all maintenance aspects themselves, the system would probably enjoy a greater acceptance if the reuse would be organised centrally for a competitive price.

Though not all **tourists** are aware of problems and difficulties related to sanitation, they are concerned about the impact of tourism in general and current wastewater management in particular. They wish for more sustainable solutions, better management and stricter regulations. All in all, tourists' acceptance of ecosan as an alternative to the current practices in wastewater management is very high. The majority of tourists stated that they were willing to support lodges' endeavours in providing more environmentally friendly services and infrastructure by putting up with slightly higher prices for accommodation. The respondents view ecosan as a good solution and a practice that should be employed more, especially within National Parks in Mongolia. They see many advantages of the ecosan toilets, most importantly, the protection of the environment and the prevention of pollution along with the beneficial effects of compost. Yet, they also recognize some drawbacks, such as the need for education and the plus in maintenance work for ecosan toilets. The acceptance of products fertilized with sanitised excreta is unexpectedly high: almost all tourists view such products positively, as long as the proper guidelines are followed. They think that reuse and production of wood, berries, or vegetables in greenhouses could prove to be an additional source of income for local people.

The study with **local people** of Khatgal showed that solid waste and sanitation issues constitute the most prominent concerns, whereby sanitation issues of lodges and campsites are perceived to be more important than their own problems. Generally, local people showed a high interest in alternatives, though it must be kept in mind that for them, sanitation is only of second importance. A crucial reason for their support is that conventional pit latrines are difficult to build under the current conditions with high groundwater tables and permafrost. The main advantages were considered to be hygienic improvements and the prevention of pollution, an improvement in management of the lodge owners' sanitation system, increased user comfort, and the tackling of current construction problems. The most limiting factors for the acceptance of ecosan are on the one hand the higher cost of ecosan toilets, and on the other hand the maintenance work, especially concerning reuse. If the reuse would be organised centrally, ecosan would enjoy a very high acceptance, though few could contribute



to this financially. Further improvements and adaptations in the design are necessary to make the ecosan system useable in winter.

### ***Reuse Options***

Non-food crops such as trees generally enjoyed the highest acceptance by all different stakeholders. These results must be seen in connection with the need for reforestation and sustainable forest management, which is widely recognized. Using ecosan fertilizer for reforestation projects within Mongolia could be a very sensible option to counter the continuing deforestation of the country. Also native plants such as sea buckthorn could be a suitable choice; the plants are very well adapted to the local environment and climate, are not overly demanding in what concerns irrigation, and are also potential cash crops. Berries and fruits that grow above the ground are also well accepted. An option that was not well liked in Khatgal was animal forage, as it is too cold for agriculture. Nevertheless, this could be a feasible alternative in the arable regions in Mongolia to lessen the pressure on grasslands. Vegetables are definitely not the reuse option which is primarily recommended, both due to the fact that many people have difficulties in accepting the reuse of excreta on food crops, and because many of the vegetables that are eaten in Mongolia are root crops, which are more critical from a hygienic point of view. It could be an alternative as a professionally run businesses in urban areas, where as strict control can be exerted – but as a family alternative, it is rather inauspicious. Options that were also mentioned included burning or the burying of the sanitised excreta; however, this should rather be regarded as a last resort, as many nutrients are lost.

### ***Discussion***

Among others, the following aspects are crucial for the success of ecosan: The reuse concept must be chosen in such a way that it can be accepted by all stakeholders. Furthermore, the way how the maintenance of the toilets is organised (centralised or private), is crucial. There are arguments in favour or against each of these two options; it is a decision that must be made by the involved user groups. In addition, costs are a crucial factor; while ecosan proves to be attractive for lodges, it must be considered that the level of poverty is high in Mongolia – many families recognise the importance of sanitation, but are not able to pay much more for an environmentally sustainable solution. These factors are vital to take into account when new ecosan projects are implemented in Mongolia.

With the necessary adjustments in the design of the toilet so that it can also be used in the extreme cold, and with a sensibly chosen, adapted and sustainable reuse concept, ecosan can be a socially acceptable, economic, and environmentally friendly solution to overcome the current problems with wastewater management in the Lake Khuvsgul region. It could even prove a chance for the wider implementation of the eco-tourism concept.

# 11 REFERENCES

## 11.1 Print Sources

- ALSÉN, K.W. & JENSSEN, P. (Eds.) (2004): Ecological Sanitation: for Mankind and Nature. Ås, Norwegian University of Life Sciences: 1-35.
- ARIUNBOLD, D. (2007): Personal Interview, Member of Agriculture and Rural Development Project (NGO), August 28<sup>th</sup>, 2007.
- VON ARX, J. (2008): Geo-Ecological Research in the Khuvsgul Area, Northern Mongolia. Master Thesis (in German). Department of Geosciences, University of Basel.
- BAATARBILEG, P. (2007): Personal Interview, President of the Mongolian Mining Recreation Association, August 28<sup>th</sup>, 2007.
- BATBAYAR, Ch. (2007): Personal Interview (Environmental Inspector Khatgal), July 17<sup>th</sup>, 2007.
- BATBOLD, KH., TUUL, Z. & OYUN, B. (2004): Access to Water and Sanitation Services in Mongolia. A Joint Report by the Government of Mongolia, UNDP Mongolia, UNICEF & WHO. Ulaanbaatar, UNDP Mongolia: 1-84.
- BATKHISHIG, O. (2006): Soils of the Lake Hövsgöl Area and its Watershed. In: Goulden, C. E., Sitnikova, T., Gelhaus, J. & Boldgiv, B. (Eds.): The Geology, Biodiversity and Ecology of Lake Hövsgöl (Mongolia). Leiden: Backhuys Publishers: 93-113.
- BATIMA P., NATSAGDORJ L., GOMBLUUDEV P. & ERDENETSETSEG B. (2005): Observed Climate Change in Mongolia. (= AIACC Working Paper No.12). Ulaanbaatar: Institute of Meteorology and Hydrology, 1-26.
- BATIMA, P., BATNASAN, N. & BOLORMAA, B. (2004): Trends in River and Lake Ice in Mongolia. (= AIACC Working Paper No. 4). Ulaanbaatar: Institute of Meteorology and Hydrology, 1-12.
- BATJARGAL, Z. (1997): Desertification in Mongolia. In: ARNALDS, O. & ARCHER, S. (Eds.) (1999): Case studies of Rangeland Desertification. Proceedings of the Rangeland Desertification, International Workshop, September 1997, Iceland. (=RALA Report No. 200) Reykjavik: Rala, 107-113.
- BAYANJARGAL (2007): Personal Interview, Khatgal Community Member and Environmental Activist, July 16<sup>th</sup>, 2007.
- BLUNDEN, J. (2004): Mongolia. The Bradt Travel Guide. London: Bradt Travel Guides: 1-390.
- CHULUUNTSETSTEG (2007): Personal Interview (Vegetable Producer and Owner of a GTZ Ecosan Pilot Project Toilet in Ulaanbaatar), May 25<sup>th</sup>, 2007.
- CIDP – COMMUNITY-LED INFRASTRUCTURE DEVELOPMENT PROJECT (2006): Hygiene and Sanitation Situation Report for Ger Areas, Mongolia. Ulaanbaatar: City of Ulaanbaatar, 1-28.
- CONRADIN, K. (2006): "Slum Cities" und "Cities of Hope": Problemlagen und Perspektiven südasiatischer Grossmetropolen am Beispiel einer illegalen Squattersiedlung im südindischen Bangalore. Unpublished Paper for the Advanced Seminar "Global Cities-Megacities – Herausforderungen und Perspektiven" in the Winter term 2006/2007. Institute of Geography, Albert-Ludwigs Universität Freiburg i. Br, 1-30.

- CONSERVATION INK (Ed.) (2004): Khovsgol National Park. Map and Guide. Jackson, Wyoming: Conservation Ink.
- COOK, I. (2005): Participant Observation. In: FLOWERDEW, R. & MARTIN, D. (EDS.): *Methods in Human Geography. A Guide for Students Doing a Research Project*. Harlow: Prentice Hall, 167-188.
- COPE, M. (2005): Coding Qualitative Data. In: HAY, I. (Ed.): *Qualitative Research Methods in Human Geography. Second Edition*. South Melbourne, Victoria: Oxford University Press, 223-233.
- DORE, G., NAGPAL, T. (2006): Urban Transition in Mongolia: Pursuing Sustainability in a Unique Environment. In: *Environment: Science and Policy for Sustainable Development* 48 (6): 10-24.
- DWYER, M. & LIMB, C. (2001): Introduction: Doing Qualitative Research in Geography. In: LIMB, M. & DWYER, C. (EDS.): *Qualitative Methodologies for Geographers: Issues and Debates*. London: Arnold, 1-21.
- ECOSANRES (2003): Closing the Loop on Phosphorus. (= Ecosanres Fact Sheet No. 4.). Stockholm: Ecosanres & Stockholm Environment Institute, 1-2.
- ENKHTUVSHIN, G. (2007): Personal Interview, Head of the Foreign Affairs Division of the Mongolian Organic Farmer's Association, August 28<sup>th</sup>, 2007.
- EPA – UNITED STATES ENVIRONMENTAL PROTECTION AGENCY, OFFICE OF WATER (2006): Wastewater Management Fact Sheet: Energy Conservation. Washington: EPA, 1-7.
- ESREY, S. A. (2000): Towards a Recycling Society. Ecological Sanitation – Closing the Loop to Food Security. In: *Proceedings of the 1<sup>st</sup> Int. Symposium on Ecological Sanitation in Bonn 30<sup>th</sup> – 31<sup>st</sup> October 2000*. Eschborn: GTZ, 30-40.
- ERLBECK, R. (2007): Personal Interview, Director of the Integrated Urban Development and Construction Sector Programme of the GTZ, May 30<sup>th</sup>, 2007.
- FLICK, U. (2006): *Qualitative Sozialforschung. Eine Einführung. Vollständig überarbeitete und erweiterte Neuauflage, 4. Auflage*. Hamburg: Rowohlt Taschenbuch Verlag, 1-446.
- GALLATI, M. (2007): Ozonierung modernisiert die Abwasserreinigung. In: *Schweizer Gemeinde* 9/2007, Vol 44 (9): 19-20.
- GANBAATAR, B.-O. (2007): Personal Interview, Owner of the M.S. Guesthouse and Khatgal Resident, July 3<sup>rd</sup>, 2007.
- GOM & UNDP – GOVERNMENT OF MONGOLIA & UNITED NATIONS DEVELOPMENT PROGRAMME (2003): *Human Development Report Mongolia 2003: Urban-Rural Disparities in Mongolia*. Ulaanbaatar: UNDP Mongolia, 1-79.
- GOULDEN, C.E., TUMURTOGOO, E., KARABANOV, E. & MONGONTSESTEG, A. (2006): The Geological History and Geography of Lake Hövsgöl. In: GOULDEN, C. E., SITNIKOVA, T., GELHAUS, J. & BOLDGIV, B. (EDS.): *The Geology, Biodiversity and Ecology of Lake Hövsgöl (Mongolia)*. Leiden: Backhuys Publishers, 1-19.
- HAMMER, M. & OTTERPOHL, R. (2006): Pharmaceutical Residues in the Environment. Advantages and Disadvantages of Conventional Wastewater Treatment and Ecological Sanitation Systems. In: *Proceedings of 4<sup>th</sup> International Water Forum "AQUA Ukraine -*

- 2006" and International Forum "Ecological Technologies - 2006", September 19th - 21<sup>st</sup>, 2006. Kiev: (s.n.), 474-477.
- HARPER, M., GRUYS, R. & BROWN N. (EDS.) (1998): Lake Hovsgol National Park. A Visitor's Guide. Ulaanbaatar: Discovery Initiatives, 1-75.
- HAWKINS, R. MARMER, P. & MOIR, K. (2006): Final Report of the Participatory Rural Appraisal in the Southern Gobi, November 12th to 23rd, 2006. (s.l): (s.n), 1-40.
- HEAD OFFICE OF GEODESY AND CARTOGRAPHY OF THE USSR (1971-1983): Map of Mongolia, Scale 1:500'000, Sheet M-47-b (Khuvsgul). Moscow, Glavnoe Upravlenie Geodezii i Kartografii (GUGK).
- HEEB, J. & GNANAKAN, K. (2003): Source Separation - New Toilets for Indian Slums. In: Proceedings of the 2<sup>nd</sup> Int. Symposium on Ecological Sanitation in Lübeck, April 7<sup>th</sup> – 11th 2003. Eschborn: DWA & GTZ: 55-62.
- HENN, M., WEINSTEIN, M, & FOARD, N. (2006): A Short Introduction to Social Research. London: Sage Publications, 1-285.
- HOWITT, R. & STEVENS, S. (2005): Cross-Cultural Research: Ethics, Methods and Relationships. In: HAY, I. (ED.): Qualitative Research Methods in Human Geography. Second Edition. South Melbourne, Victoria: Oxford University Press, 30-20.
- JACKSON, P. (2001): Making Sense of Qualitative Data. In: LIMB, M. & DWYER, C. (EDS.): Qualitative Methodologies for Geographers: Issues and Debates. London: Arnold, 199-214.
- JENSSEN, P. (2007): Personal Communication, Professor, Agricultural University of Norway, October 28<sup>th</sup>, 2007.
- JENSSEN, P., ET AL. (2004): Ecological Sanitation and Reuse of Wastewater. Ecosan. A Thinkpiece on Ecological Sanitation. Ås: Agricultural University of Norway, 1-18.
- JENSSEN, P., GREATOREX, J. M. & WARNER, W.S. (2004): Konzeptionen dezentralisierter Abwasserreinigung und Stoffstrommanagement. Skript zum Kurs WH33, Weiterbildendes Studium Wasser und Umwelt der Universität Hannover. Sommersemester 2004. Hannover: Universität Hannover, 1-65.
- JOHANSSON, B. (2004): Foreword to the 2<sup>nd</sup> Edition of Ecological Sanitation. In: WINBLAD, U. & M. SIMPSON-HÉBERT (EDS.): Ecological Sanitation. Revised and Enlarged Edition. Stockholm: Stockholm Environment Institute, VI.
- JOHANSSON, M. ET. AL. (2000): Urine Separation – Closing the Nutrient Cycle. Final Report of the R&D Final Report on the R&D Project: Source-Separated Human Urine – A Future Source of Fertilizer for Agriculture in the Stockholm Region? Stockholm: Stockholm Vatten, Stockholmshem & HSB National Federation: 1-40.
- JÖNSSON, H., RICHERT STINTZING, A., VINNERÅS, B. & SALOMON, E. (2004): Guidelines on the Use of Urine and Faeces in Crop Production. (= Ecosanres Publication Series 2004-2). Stockholm, Stockholm Environment Institute: 1-35.
- KESBY, M., KINDON, S. & PAIN, R. (2005): 'Participatory' Approaches and Diagramming Techniques. In: FLOWERDEW, R. & MARTIN, D. (EDS.): Methods in Human Geography. A Guide for Students Doing a Research Project. Harlow: Prentice Hall, 144-166.

- KHATGAL COMMUNITY MEETING (2007a): Community Meeting in Khatgal on the 16<sup>th</sup> of July 2007. 19 participants, as listed in Appendix 4.
- KHATGAL COMMUNITY MEETING (2007b): Community Meeting in Khatgal on the 17<sup>th</sup> of July 2007, 14 participants, as listed in Appendix 4.
- KOHN, M. (2005): Mongolia. Victoria, New South Wales: Lonely Planet Publications-Pty Ltd. 1-296.
- KVARNSTRÖM, E. ET AL. (2006): Urine Diversion: One Step Towards Sustainable Sanitation. (= Ecosanres Publication Series 2006-1). Stockholm, Stockholm Environment Institute: 1-64.
- LANGE, J. & OTTERPOHL, R. (2000): Abwasser: Handbuch zu einer zukunftsfähigen Wasserwirtschaft. 2. überarbeitete Ausgabe, herausgegeben von MALLBETON GmbH. Donaueschingen-Pföhren: Mall-Beton GmbH, 1-301.
- LARSEN, T. A., PETERS, I., ALDER, A., EGGEN, R. I., MAURER, M., & MUNCKE, J. (2001): Re-engineering the toilet for sustainable wastewater management. In: Environ. Sci. Technol. 2001, 35 (9): 192A-197A.
- LI, T.S.C. (1999): Sea Buckthorn: New Crop Opportunity. In: JANICK, J. (ED.): Perspectives on New Crops and New Uses. Alexandria, Virginia: ASHS Press, 335–337.
- LIENERT, J. & LARSEN, T. A. (2006): Considering User Attitude in Early Development of Environmentally Friendly Technology: A Case Study of NoMix Toilets. In: Environ. Sci. Technol. 2006, 40 (16): 4838-4844.
- LINDBLOM, H. (2006): Designing Local Sanitation Facilities for Mongolia. Master's Thesis, Department of Civil and Environmental Engineering, Division of Sanitary Engineering, Luleå: Luleå University of Technology, 1-74.
- MARRIOT, P. (2005a): Executive Summary and Recommendations. In: GANKHUYAG, U. (ED.): Economic and Ecological Vulnerabilities and Human Security in Mongolia. Ulaanbaatar: UNDP Mongolia, 1-18.
- MARRIOT, P. (2005b): Ecological Vulnerability and Human Security in Mongolia. In: GANKHUYAG, U. (ED.): Economic and Ecological Vulnerabilities and Human Security in Mongolia. Ulaanbaatar: UNDP Mongolia, 67-95.
- MARTI, W. J. (2007): Mit der Jurte nach Ulaanbaatar. - In: Neue Zürcher Zeitung, 14./15 April 2007, 5.
- MCCANN, B. (2005): The Sanity of Ecosan. In: Water21, 3 (2), April 2005: 28-30.
- MORGAN, P. (2007): Toilets that Make Compost. Low-cost, sanitary toilets that produce valuable compost for crops in an African context. Stockholm: Stockholm Environment Institute & EcoSanRes Programme: 1-99.
- MYUNG, N. C. (2007): Personal Interview, Medical Doctor and President of Well International (Korean Health Care Organisation) August 17<sup>th</sup>, 2007.
- NARANCHIMEG (2007): Personal Interview, Manager of Khovsgol Travel Company Ger Camp in Toilogt, July 10<sup>th</sup> 2007.

- NARANTSETSEG, TSERENPAAGMA & DAVASUREN (2007): Personal Interview. Hygiene Inspector of Khuvsgul Province in Muren, and Environmental Inspectors in Muren, Khuvsgul. July 19th, 2007.
- NBC, STC & UNICEF – NATIONAL BOARD FOR CHILDREN, SAVE THE CHILDREN & UNITED NATIONS CHILDREN'S FUND (2003): Summary Report: The Living Conditions of the Children in Peri-urban Areas of Ulaanbaatar. Ulaanbaatar: UN-Mongolia, 1-61.
- NLM – NORWEGIAN LUTHERAN MISSION (2004): The Ecosan Activity within Health Development Project – Selenge/Darkhan. Evaluation Report. (s.l.): (s.n.) 1-25.
- NSOM – NATIONAL STATISTICAL OFFICE OF MONGOLIA (2003): Mongolia 2003 Statistical Yearbook. Ulaanbaatar: NSOM.
- OTGONBAYAR (2007): Personal Communication, Ulaanbaatar Ger Camp Owner and Biologist, July 12<sup>th</sup>, 2007.
- OYUNMUNKH, B. (2008): Ecological Vulnerability on the Western Shoreline of Lake Khuvsgul, Khuvsgul National Park. Master Thesis. Mongolian Landscape Research Centre, National University of Mongolia, Ulaanbaatar.
- PAHL-WOSTL, C., SCHÖNBORN, A, WILLI, N., MUNCKE, J. & LARSEN, T.A. (2003): Investigating Consumer Attitudes towards the New Technology of Urine Separation. In: Water Science and Technology, 48 (1): 57–65.
- RALOFF, J. (2004): Dead Waters. Massive Oxygen-starved Zones are Developing Along the World's Coasts. In: Science News. 165 (23): 360-365.
- RICHERT STINTZING, A. ET AL. (2007): Urine Diverting Toilets in Climates with Cold Winters. Technical Considerations and the Reuse of Nutrients with a Focus on Legal and Hygienic Aspects. Utrecht & Munich: WECF (Women in Europe for a Common Future), 1-41.
- RIDEDERSTOLPE, P. (2004): Introduction to Greywater Management. (= Ecosanres Publication Series 2004-4). Stockholm, Stockholm Environment Institute: 1-19.
- ROSSABI, M. (2005): Modern Mongolia. From Khans to Commissars to Capitalists. Berkeley: University of California Press, 1-397.
- SCHENK, A. (2006): Mongolei. Mit einem Vorwort von Galsag Tschinag. (= Becksche Reihe Länder). München: C.H. Beck: 1-225.
- SCHÖNNING, C. & STENSTRÖM, TH. A. (2004): Guidelines on the Safe Use of Urine and Faeces in Ecological Sanitation Systems. (= Ecosanres Publication Series 2004-1). Stockholm, Stockholm Environment Institute: 1-38.
- SELENGE (2007): Personal Interview, Manager of the Blue Pearl Ger Camp in Jankhai, July 10th, 2007
- SIEGRIST, H. ET AL. (2003): Mikroverunreinigungen: Abwasserentsorgung vor neuen Anforderungen? In: Eawag News 57, 30 (2): 7-10.
- SKELTON, T. (2001): Cross-Cultural Research: Issues of Power, Positionality and 'Race'. In LIMB, M. & DWYER, C. (EDS.) (2001): Qualitative Methodologies for Geographers: Issues and Debates. London: Arnold: 87-100.

- STEEN, P. (1998): Phosphorus Availability in the 21st Century: Management of a Nonrenewable Resource. *Phosphorus and Potassium* 217 (5): 25–31.
- STENSTRÖM, T.A. (2001): Reduction Efficiency of Index Pathogens in Dry Sanitation Systems Compared with Traditional and Alternative Wastewater Treatment Systems. Proceedings of the 1<sup>st</sup> Int. Conference on Ecological sanitation in Nanning, China, October 2001, 1-5.
- TAUXE, R.V. & COHEN, M.L. (1995): 'Epidemiology of diarrheal diseases in developed countries.' In: BLASER, M.J., SMITH, P.D., RAVDIN, J.I. & GREENBERG, H.B. (EDS.): *Infections of the gastrointestinal tract*. New York: Raven Press Ltd, 37-51.
- THOMAS, S.C. & M'CLOUGHLIN, C. (1997): *Sea Buckthorn Production Guide*. Peachland BC, Canada Seabuckthorn Enterprises Limited: 1-19.
- TIESSEN, H. (1995): Introduction and Synthesis. In: TIESSEN, H. (Ed.): *Phosphorus in the Global Environment: Transfers, Cycles and Management*. (= *Scope*, 54). Chichester, John Wiley & Sons: 1-6.
- UN – UNITED NATIONS (2002): *Plan of Implementation of the World Summit on Sustainable Development*. World Summit on Sustainable Development, September 4<sup>th</sup>, 2002. New York: UN, 1-62.
- UN WWAP – UNITED NATIONS WORLD WATER ASSESSMENT PROGRAMME (2003): *World Water Development Report*. CD-ROM. Paris: United Nations.
- UNDP – UNITED NATIONS DEVELOPMENT PROGRAMME (2006): *Human Development Report 2006. Beyond scarcity: Power, poverty and the global water crisis*. Published for the United Nations Development Programme (UNDP). New York, Palgrave Macmillan: 1-422.
- UNEP – UNITED NATIONS ENVIRONMENT PROGRAMME (2004): *Financing Wastewater Collection and Treatment in Relation to the Millennium Development Goals and World Summit on Sustainable Development Targets on Water and Sanitation*. 8<sup>th</sup> Special Session of the Governing Council/Global Ministerial Environment Forum in Jeju, Republic of Korea, March 29th-31st, 2004. (s.l): UNEP: 1-26.
- UNESCO/IHP & GTZ – INTERNATIONAL HYDROLOGICAL PROGRAMME OF THE UNITED NATIONS EDUCATIONAL, SCIENTIFIC AND CULTURAL ORGANISATION & GERMAN AGENCY FOR TECHNICAL COOPERATION (2006): *Capacity Building for Ecological Sanitation. Concepts for Ecologically Sustainable Sanitation in Formal and Continuing Education*. Paris, Eschborn: UNESCO IHP & GTZ: 1-156.
- UN-Habitat – UNITED NATIONS HUMAN SETTLEMENTS PROGRAMME (2003): *The Challenge of Slums – Global Report on Human Settlements 2003*. Earthscan Publications, London: 1-310.
- UN-WATER (2006): *UN Water Thematic Initiatives: Coping with Water Scarcity*. Geneva & New York: UN-Water, 1-12.
- URBANSKY, S. (2007): *Der Traum der Zelter vom Beton*. – In: *Neue Zürcher Zeitung*, 21./22. Juli 2007, B3.
- VALENTINE, G. (2001): *At the Drawing Board. Developing a Research Design*. In: LIMB, M. & DWYER, C. (EDS.): *Qualitative Methodologies for Geographers: Issues and Debates*. London, Arnold: 41-55.

- VINNERÅS, B. & JÖNSSON, H. (2003): Separation of Faeces Combined with Urine Diversion – Function and Efficiency. In: Proceedings of the 2<sup>nd</sup> Int. Symposium on Ecological Sanitation in Lübeck, April 2003: 579-586.
- VINNERÅS, B. (2002): Possibilities for Sustainable Nutrient Recycling by Faecal Separation Combined with Urine Diversion. Doctoral Thesis, Swedish University of Agricultural Sciences. (= Acta Universitatis Agriculturae Sueciae, Agraria 353). Uppsala, Swedish University of Agricultural Sciences: 1-88.
- VOSTOKOVA, E. A. & GUNIN, P. D. (EDS.) (2005): Ecosystems of Mongolia Atlas. A joint production of the Russian Academy of Sciences, Institute of Ecology and Evolution, and the Mongolian Academy of Sciences, Institute of Botany. Moscow: Russian Academy of Sciences, 1-48.
- WERNER, CH. ET AL. (2003). Reasons and Principles for ecological Sanitation. In: Proceedings of the 2<sup>nd</sup> Int. Symposium on Ecological Sanitation in Lübeck, April 2003: 23-30.
- WHO – WORLD HEALTH ORGANISATION (2006): WHO Guidelines for the Safe Use of Wastewater, Excreta and Greywater. Geneva: WHO, Volumes I – IV. Geneva: WHO.
- WHO/UNICEF JMP – THE WHO AND UNICEF JOINT MONITORING PROGRAMME FOR WATER SUPPLY AND SANITATION (2000): Global Water Supply and Sanitation Assessment 2000 Report. Geneva & New York, WHO & UNICEF: 1-80.
- WINBLAD, U. & M. SIMPSON-HÉBERT (EDS.): Ecological Sanitation. Revised and Enlarged Edition. Stockholm: Stockholm Environment Institute, 1-141.
- WINCHESTER, H. P. M. (2005): Qualitative Research and its Place in Human Geography. In: HAY, I. (ED.): Qualitative Research Methods in Human Geography. Second Edition. South Melbourne, Victoria: Oxford University Press, 3-18.
- WORDEN, R. L. & SAVADA, A. M. (EDS.) (1991): Mongolia: A Country Study. 2<sup>nd</sup> Edition. Washington: Federal Research Division, Library of Congress, 1-320.
- WORLD BANK (2002): Mongolia Environment Monitor 2002. Ulaanbaatar: World Bank Mongolia Office: 1-38.
- WORLD BANK (2004): Mongolia Environment Monitor 2004. Environmental Challenges of Urban Development. Ulaanbaatar: World Bank Mongolia Office, 1-33.



## 11.2 Internet Sources

- ADB – ASIAN DEVELOPMENT BANK (2007): Mongolia 2007: A Fact Sheet. Ulaanbaatar: Asian Development Bank, 1-4. URL: [http://www.adb.org/Documents/Fact\\_Sheets/MON.pdf](http://www.adb.org/Documents/Fact_Sheets/MON.pdf) (accessed September 17<sup>th</sup>, 2007).
- CIA – CENTRAL INTELLIGENCE AGENCY (2007): The World Factbook: Mongolia. URL: <https://www.cia.gov/library/publications/the-world-factbook/geos/mg.html#People> (accessed September 17<sup>th</sup>, 2007.)
- CIA – CENTRAL INTELLIGENCE AGENCY (1996): General Map Showing Province Boundaries, Names, and Capital Cities. Washington, D.C.: Central Intelligence Agency. URL: [http://commons.wikimedia.org/wiki/Image:Mongolia\\_1996\\_CIA\\_map.jpg](http://commons.wikimedia.org/wiki/Image:Mongolia_1996_CIA_map.jpg) (accessed November 11<sup>th</sup>, 2007).
- COLWELL, C. (2007): Human Urine Safe, Productive Fertilizer. In: The Washington Post. October 8<sup>th</sup>, 2007. URL: <http://www.washingtonpost.com/wp-dyn/content/article/2007/10/08/AR2007100801028.html> (accessed October 24<sup>th</sup>, 2007).
- FAO – FOOD AND AGRICULTURE ORGANISATION OF THE UNITED NATIONS (2004): FAO Statistical Yearbook. Country Profiles: Mongolia. URL: [http://www.fao.org/es/ess/yearbook/vol\\_1\\_2/pdf/Mongolia.pdf](http://www.fao.org/es/ess/yearbook/vol_1_2/pdf/Mongolia.pdf) (accessed September 19<sup>th</sup>, 2007)
- ILLI, M. (2005): Abwasser. In: Historisches Lexikon der Schweiz. URL: <http://www.hls-dhs-dss.ch/textes/d/D7861.php> (accessed June 21<sup>st</sup>, 2007).
- MADIN, K. (2006, October 15th): RE: [EcoSanRes] Dry Sanitation in Cold Climates. [Msg. 1581ff]. Message posted to: <http://tech.groups.yahoo.com/group/ecosanres/msearch?query=pee+cube&pos=30&cnt=10> (accessed October 15<sup>th</sup>, 2007)
- MINISTRY OF ROAD, TRANSPORT AND TOURISM (2006): Official Tourism Website. Tourism Sector Profile. URL: <http://www.mongoliatourism.gov.mn/index.php?action=menudata&id=7> (Accessed Oct. 29<sup>th</sup>, 2007).
- SVGW & BUWAL– SCHWEIZERISCHER VEREIN DES GAS- UND WASSERFACHES & BUNDESAMT FÜR UMWELT, WALD UND LANDSCHAFT (2005): Wasserverbrauch im Haushalt. URL: <http://www.trinkwasser.ch> (accessed: January 6<sup>th</sup>, 2007.)
- UB POST (2007): Millionth Citizens Welcomed. UB Post 10.05.2007. URL <http://ubpost.mongolnews.mn/> (accessed May 24<sup>th</sup>, 2007)
- UNICEF – United Nations Children’s Fund (2007): At a Glance: Mongolia. URL: [http://www.unicef.org/infobycountry/mongolia\\_statistics.html](http://www.unicef.org/infobycountry/mongolia_statistics.html) (accessed September 19<sup>th</sup>, 2007).
- WHO/UNICEF JMP – The Who And Unicef Joint Monitoring Programme For Water Supply And Sanitation (2006): Coverage Estimates Improved Sanitation – Mongolia. Updated in June 2006. URL: [http://www.wssinfo.org/pdf/country/MNG\\_san.pdf](http://www.wssinfo.org/pdf/country/MNG_san.pdf) (accessed September 18<sup>th</sup>, 2007)

# APPENDIX

## ***Contents Appendix***

<b>APPENDIX 1</b>	<b>Interviews with Lodge Owners .....</b>	<b>141</b>
A 1.1	MS Guesthouse .....	141
A 1.2	Bayangol Guesthouse,.....	143
A 1.3	Turt Ger Camp .....	144
A 1.4	Khatgal Guesthouse .....	146
A 1.5	Ashiai Ger Camp.....	147
A 1.6	Dalaiban Ger Camp .....	147
A 1.7	Huvsgul Dalai Ger Camp .....	149
A 1.8	Huvsgul Dul Ger Camp .....	150
A 1.9	Huvsgul Eco Tour Ger Camp .....	151
A 1.10	Blue Pearl Ger Camp .....	152
A 1.11	Nature's Door Ger Camp .....	153
A 1.12	Toilogt Ger Camp.....	156
A 1.13	Khuvsgul Inn .....	157
A 1.14	Nature's Door Guesthouse .....	159
A 1.15	North Port Ger Camp .....	160
A 1.16	Yerlug Ger Camp .....	161
A 1.17	Bonda Lake Guesthouse .....	163
A 1.18	Sunway Guesthouse .....	165
<b>APPENDIX 2</b>	<b>Tourists' Questionnaire.....</b>	<b>166</b>
<b>APPENDIX 3</b>	<b>Questionnaire for Lodges .....</b>	<b>168</b>
A 3.1	Short Questionnaire for Lodges, Mongolian Version .....	168
A 3.2	Short Questionnaire for Lodges, English Translation.....	169
<b>APPENDIX 4</b>	<b>Community Meeting Participants .....</b>	<b>170</b>
A 4.1	Participants of the 1 <sup>st</sup> Community Meeting, July 16 <sup>th</sup> , 2007 .....	170
A 4.2	Participants of the 2 <sup>nd</sup> Community Meeting, July 17 <sup>th</sup> , 2007 .....	170
<b>APPENDIX 5</b>	<b>Green Future Reforestation Project .....</b>	<b>172</b>
A 5.1	Information Letter for Tourists .....	172
A 5.2	Project Information .....	173

# APPENDIX 1 INTERVIEWS WITH LODGE OWNERS

## A 1.1 MS Guesthouse

<u>Name of the camp:</u> Munkh Saridag Guesthouse (MS Guesthouse)	<u>Location (Map) No:</u> 1
<u>Name of camp owner:</u> Mr. Ganbaatar	<u>Name of interviewee:</u> Mr. Ganbaatar
<u>Capacity of the camp:</u> 40 tourists (7 gers, 1 dorm)	<u>Existing since:</u> In this location since 2003, before for three years in a different place
<u>Open through:</u> all year	<u>Current wastewater practice:</u> Ventilated improved pit toilet with a holding tank. Separate tanks for greywater and blackwater.
<u>Utilisation:</u> 600 to 700, mainly foreign	<u>Classification:</u> budget
<u>Interview date:</u> July 3 <sup>rd</sup> , 2007	

*KC (K. Conradin): Are you aware of current sanitation problems around Lake Khuvsgul?*

**Mr. Ganbaatar:** Yes. Especially the places that are close to the lake and the all the campsites near the lake need to be very careful and need a good sanitation system with a very high quality. In the town centre, I feel that it is not so much a problem because there are many families around that just use pit toilets anyways. However, an environmentally friendly toilet is always better.

A good standardisation of the new system is very important. Any kind of good idea in relation to sanitation will be a lot easier to implement both for the people who are using a new toilet system and for the environmental inspectors if there are standards. Even if somebody has a very good idea [in relation to sanitation], if the inspectors don't agree, it will never work.

*What is the biggest advantage of the no-mix toilet?*

It's a good idea, because it is much cleaner [to handle]. To use for planting, maybe as a Mongolian, I don't like this so much, but still, I can carry out two separate things of the toilet, and this is much easier than to empty a conventional holding tank. I only need a jeep with a trailer, and then I can carry it on my own.

*What is the biggest disadvantage of this toilet, what don't you like about it?*

I saw it at the Khuvsgul Inn, and the container that holds the faeces is open. This is not a good idea, it's not good to carry it out of the toilet like this. This toilet comes from Africa, doesn't it? I think here, the weather condition is much cooler, and I think it doesn't dry up. But let's see. Maybe it doesn't dry quickly in this weather. But the good thing is that I can check on this toilet [referring to the toilet in Khuvsgul Inn], because it is just right here in Khuvsgul inn, at my neighbour's place, so I can go there all the time and see what it looks like.

*Would you be willing to build such a toilet, are you thinking about building one?*

Sure, if the inspectors say that this kind of toilet, this design and style are fine, then yes. I strongly recommend you to make this toilet agreed by the inspector. Otherwise, it will be very hard to establish this kind of toilets here.

*Are there any other preconditions for you to build this toilet?*

I don't know, I don't have any idea.

*How much should a toilet like this cost maximally?*

I think it should cost around 500'000 Tugrik for two toilets (two cubicles).

*How do you think the reuse should be organized?*

At the moment, the only way to use it is if we reuse it privately, for private planting. Because right now, we don't have any NGO who is working on this. Maybe it would be a good idea to have an NGO that is responsible for the planting, and could help in replanting degraded soils, or reforestation.

*Where do you think should the urine and faeces be reused?*

I think we should put it at the same place where we dump the dirty water, at some distance from the town. This place lies about 8 km South of Khatgal.

*Would it be an option to reuse it on trees?*

Yes, but only if it is far away from human settlements. Because, if we reuse the faeces, and somebody maybe has a stomach disease, then it would not be a good idea if this was close by human settlements. Did you check this? Because, we need to know this; it is very important for us to get research results. It is especially important that the inspectors get these research results, because we are not professional people. We respect what the inspectors declares the safest, and the cleanest and most ecological way to build toilets, and the same applies to the reuse concepts.

*So if the inspectors say that these toilets are good, and that the sanitised excreta are safe to reuse, would you reuse it then, for instance on trees?*

Yes, sure I would. I would like to say that it is very good that we can see this toilet at Khuvsgul Inn as a demonstration object. It is a very good checking point, to find out how it works in this kind of weather conditions.

After having seen this toilet, we maybe also come up with improvements or alterations to the way the toilet is built at Khuvsgul Inn. It serves as a good example and demonstration ground.

*If the inspection committee agrees to this kind of toilets, would you support that these toilets are made mandatory in the National Park?*

Yes, every lodge and tourist camp can build this toilet. All guesthouses and tourist camps are just waiting for a good new standard and good ideas for sanitation. The standard now [flush toilets] does not work here under this weather conditions and with the current infrastructure. The pipes freeze in the winter, and it needs a lot of water. Furthermore, we do not know where to put this water afterwards. So it will be a good idea to use this kind of [no-mix] toilets. It is good because we save water, and because we have less pollution ... it is good in any way! [laughs]. All tourist camps are waiting for the one good standard practice of dealing with wastewater. If we use this toilet, we can prevent many problems: we do not have to be afraid of faeces, we do not have to be afraid of smells or of pollution, and we do not have to be scared of the inspectors! What other measures to protect the environment would you suggest?

Planting trees would be very important. My parents tell me that when they moved here in the 1940s, the hills west of Khatgal, and the area west of the town, east of the hills, near the airport all used to be forested. Also the place where the airport is located today used to be covered by forest. This was a good protection against wind. Now, there is much more wind. So planting trees would be a very good idea.

*So it would actually be a good idea to reuse the excreta from the toilet to replant these trees?*

Yes, if some kind of NGO or organisation could do this, it would be a very good idea. Our town has many unemployed people who can work on this. [Discussion in Mongolian]

But what shall we do about the greywater?

*Well, greywater is not so dangerous from a pollution point of view – what is really dangerous are the faeces. They should not just be dumped into the environment without treatment. But for greywater, there are simple and very efficient treatment option.*

What is really important is that the inspectors get the result of your research, so they understand this. You should explain this all to them, and then we listen to them. This [meaning: sanitation] really makes some noise at the moment, but it is not a problem. If we have a very good standard that is good for the health of humans, that is ecological and with a low impact on nature, if we have such a standard, then everybody would love to follow it.

*How much did you invest in your current toilet?*

Around 300'000 Tugrik. This was in 2004. The toilet I have now works well, its safe for the humans and it economically very cheap. Concerning nature, we are still looking for ways how we can improve it.

*What is the current system?*

[It is currently a lined pit latrine – when full, the contents are sucked out and dumped on the central waste dump]. The blackwater holding tank has a volume of 1.5x3.5 m and is 2 m deep (10.5 m<sup>3</sup>). We never had to empty it so far. We have never emptied this tank so far. We wanted to empty it once but there was nothing, it was pretty dried up.

*Is it filling up?*

No, it is not filling up. We wanted to empty it, but there was nothing. The greywater tank is 3x2 m and is 2.5 m deep (15 m<sup>3</sup>). We have to empty this three times a summer. One emptying service cost 40'000 to 50'000 Tugrik. Currently, the rule is that we are not allowed to reuse this greywater.

At the moment, we don't know whether we will keep this toilet or whether we will build another one.

If you want to do this kind of environmental work, you should do research, and then you have to explain this to the inspectors and make standards. Now we are not allowed to use this greywater. Let the inspectors know, and let them agree to this systems, and let them know about the research results, and also give some information on how you practically reused the excreta. Otherwise, how should they know? Information is really crucial for the inspectors. Then we are ready to follow. If you offer something, and the inspector doesn't agree, then ... no way. We cannot say: "Oh, its good water, we can reuse it," because we are not professionals. The agreement of the inspectors is a must. I can also not say "this toilet looks good" – if someone had a bad disease, then maybe it can spread, so it has to be very hygienic.

## A 1.2 Bayangol Guesthouse,

<u>Name of the camp:</u> Bayangol Camp	<u>Location</u> (Map) No.: 5
<u>Name of camp owner:</u> Mrs. Khuhii, Mr. Bayanjargal	<u>Name of interviewee:</u> Mrs. Khuhii
<u>Capacity of the camp:</u> 2 gers, 8 tourists	<u>Existing since:</u> 2007
<u>Open through:</u> all year, mainly summer	<u>Current wastewater practice:</u> pit latrine
<u>Utilisation:</u> ?? (first year)	<u>Classification:</u> budget
<u>Interview date:</u> July 4 <sup>th</sup> , 2007	

*KC (K. Conradin): What are your reasons for being interested in the no-mix ecosan toilet?*

**Mrs. Khuhii:** Where my home is located, there is permafrost and water, the groundwater table is just about 1.6 m below the surface. So when we dig a pit for the toilet it always fills up with water. That is why we think this system [no-mix ecosan toilet above ground] would be very good for us.

I have already organized everything to open up a guesthouse, but just the toilet is lacking. I don't want to dig a hole. Then my daughter told me that there is this new system here, and I am very happy about this. I really had a problem with building a toilet. We dug a hole, but it is already half-collapsed and filling up with groundwater. I am very glad to see this ecosan toilet and to meet you and learn about this!

But About the greywater, what shall we do? We already built a shower...

*Well, I think for now, the regulation is that it is not allowed to infiltrate the greywater if you have a guesthouse... We have to think of something here.*

We have already built a bathroom with a shower but we don't know what to do with the greywater. At the moment, we are just infiltrating it. The shower is not only for the tourists, we are using the shower all year round also for our family. So far, we just emptied our greywater into the pit latrine.

You know, I had three children who were all of similar age. In the last few years our children were all students, so we had a very hard live. My husband is already retired; I work in the local bank. This is the first year that we are a bit better off and can invest something in the guesthouse. My son Baterdene is helping here to do all the building, with the bathroom and the toilet etc..

*Are you aware of any problems with sanitation around lake Khuvsgul, or do you know about water pollution?*

I think that the water is pure in this area, but a bit further up the lake (north), where there is more water transport, there is more pollution. The boats usually leak some petrol. You should go there and take some water samples there! I have also seen that there are now some algae growing on the surface of the rocks in that area – these stones always used to be clean. Generally you should go further up the lake to find pollution.

We can then also show our toilet to the local people as a demonstration object, and to show that it can easily be built from locally available material. My son can also easily build it.

*What further questions do you have about this ecosan toilet? What support do you think is necessary to build this toilet?*

We don't have any further questions. My son can build the toilet, no question. We would like to build two toilets. Currently, there is no information on this toilet; but I work at the bank, and I will tell all my clients about this new toilet.

*Do you see any possibility in reusing the urine as a fertilizer?*

We have already planted some trees within our fence, so I think it can be very useful to use the urine as a fertilizer. I also think that we should expand that tradition and I want to tell other people. [Mrs. Khuhii and her husband have a small garden in front of their house, where they planted several fruit trees (blackcurrant, cowberry), willow etc. They also planted some larches.]

*You know, we also had this idea that tourists can adopt a tree. They can buy a certificate for 10'000 Tugrik, and then from that money a tree could be planted and the costs for taking care of the tree could be covered. What do you think of this idea?*

[Laughs] But it is a very interesting idea. My husband Bayanjargal could be very interested and could think it is a good idea. He is a hunter and so he loves nature, and he also knows a lot on nature, and medicinal plants. So you should tell him again when you come to our house!

*What do you think is the biggest advantage of the ecosan toilet?*

The biggest advantage is that we don't destroy the soil because we don't have to dig a hole, so we are very friendly to nature. The second thing is that it is easier to maintain – we can easily empty it ourselves. The third advantage is that we can build this toilet ourselves. We just somehow need to buy the toilet seat.

*But you could maybe also build the toilet seat yourselves from locally available material....*

There is a construction material we can use to make this seat. This material is also used to make sculptures. The material is also used for cars and roads, special material, but I don't know the name. When it is dried it is like stone, but it is not cement. We will see. [In the end, the family built the toilet seat of a tree trunk and used a metal sheet to construct the diversion.]

And what do you think is the biggest disadvantage of a toilet like this?

Nothing... [laughs]. I am very happy that I met you and that I learned about this toilet.

How expensive should this toilet maximally be?

I think the maximal cost should be 150'000 Tugrik, we could build it for that if we do everything ourselves.

What is the main support that you need to build this toilet?

We just needed to learn about the concept. Otherwise we can build it ourselves.

And will you also be able to do the reuse yourselves, or do you think a professional person should do this?

There is no need for a professional maintenance, because we have the opportunity to reuse the excreta ourselves. We have some trees, and we also have vegetables. I want to reuse the excreta for the vegetables. However, my son does not like this. He thinks it is not acceptable to put the excreta on vegetables.

But you yourself think that it is a good idea?

Yes, it is a good idea, because now we also use the cow dung like that.

What vegetables do you grow?

I grow potatoes, but we also have some fruit trees. I know very well about all the plants. If we put the excreta on the soil, the plants will filter it again – they just use the beneficial parts of the excreta. So why shouldn't we put the excreta on potatoes and vegetables? [laughs]

Yes, we just have to make sure that it is all hygienic and safe, and you need to store the excreta until they are totally dry. This will take a full year or more.

Yes – I can manage these things alright.

I like this concept because my mother's sister told us you just to dig the wastes from the toilet and then to put them away. But I think, if they just put it anywhere, then it will pollute the environment, because these wastes "are oxidised" and become bad, so we pollute nature. So I am very very glad to do this in such an environmentally friendly way, this is much better!

The advantage of this toilet is also that it is very suitable to this area because this area has permafrost. My old toilet was collapsing because the permafrost there melted. Thus, after some time, our toilet collapsed. But this ecosan toilet has a big advantage that it is above the ground and we can empty and maintain it ourselves. This toilet cannot be destroyed by permafrost. I am very happy about this type of toilet. Of course, the acceptance will vary between different people, but I hope that the others will be like me. You should introduce this toilet very well and teach them to be like me, so that they understand the concept as well as I do. I had just one problem with opening up my guesthouse, and this was the toilet. So I told my sister that of course you can empty also the pit toilet, but then there is smell, and flies, and it pollutes the environment if we just put it anywhere after emptying.

Did you already have to empty your old toilet once?

No no, we just buried the old toilet and dug a new hole. But now our next pit is full. and we need to dig another one. So it's good that they learned of this concept now.

What other environmental issues are faced here?

Well, we don't have a well. We have to carry the drinking water from the Egiin Gol [people on Khatgal refer to the lower, narrower part of the lake near the village already as Egiin Gol even before it is actually a river]. Therefore, wastewater and solid waste management is important to us. We need to make sure that the lake stays clean!

At the upper part of the Egiin Gol [again referring to the more northern part of the outflow of the lake], there is the water transportation area, which I think is polluted. There are algae growing – this did not use to be like that!

**This family built their own ecosan UDD toilet including the separating seat, all from locally available material.**

## A 1.3 Turt Ger Camp

<u>Name of the camp:</u> Turt Ger Camp	<u>Location (Map) No.:</u> 4
<u>Name of camp owner:</u> Mr. Lhagvadorj	<u>Name of interviewee:</u> Mr. Lhagvadorj
<u>Capacity of the camp:</u> 25 (2007), 30 (2008) 5 gers (2007), 6 gers (2008)	<u>Existing since:</u> 2007
<u>Open through:</u> summer	<u>Current wastewater practice:</u> flush toilets with mixed blackwater and greywater holding tank
<u>Utilisation:</u> ?? (first year)	<u>Classification:</u> middle
<u>Interview date:</u> July 5 <sup>th</sup> , 2007	

### General Information

The Turt Guesthouse was newly built this year. It comprises five gers a, kitchen and a shower- and bathhouse. Mr. Lhagvadorj already owns the Turt Hotel in Muren. Behind the shower house, there is a blackwater holding tank that is roughly ca 3x3x2.5 m (=22.5 m<sup>3</sup>). The shower house contains flush toilets. Both blackwater from the

toilets and greywater from the showers will go to the holding tank. He wanted to build the holding tank deeper so that they would not have to empty it so often, but this was not possible, because there was groundwater at a depth of roughly 2.5 m. However, there is no permafrost there.

The standard is that lodges have to have a holding tank, either both for the blackwater and the greywater (separately) or together. This holding tank must be lined with cement (10 to 20 cm thick).

KC (K. Conradin): Where do you get the water from?

**Mr. Lhagvadorj:** The water is carried to the tank on the shower house by horse, from the lake.

What do you think about the no-mix ecosan toilet?

It's good to build and implement because it is easy to maintain, and easy to build and it is also economically efficient. Like this, I need to pay much less for getting the water.

And what do you think about reusing the human excreta as a fertilizer?

Well, by the picture you show me [the ecosan loop Khatgal] it is possible to reuse. I just started to build this guesthouse, so of course we will plant trees for decoration. So I think I could use the fertilizer for my trees.

So you think that trees are probably the best way to reuse the excreta?

Yes, we can do this.

And what do you think about vegetables?

I don't know about that. I don't think it is possible. If somebody else tried to reuse for the vegetables, then it's ok, but I would prefer the trees. Because I think it is a little difficult that we eat our own excreta.

How expensive should such a toilet be?

I think it depends on the toilet seat. The other material needed to build the toilet is not expensive (wood etc.). We are now building our own toilet, but I cannot say exactly how expensive it will be. I cannot really estimate how expensive this toilet should be; because, for instance, we do not need flushing water etc.

[On the way here, we talked about the price of the toilet as well and he said that 500'000 to 600'000 would be ok. His current system (just the toilets and the holding tank, without the shower) cost him about 500'000, but of course there is a lot of maintenance cost that has to be added, such as paying for the water and for frequent emptying services.]

How should the reuse be organized – could you do that yourself or should it be centralised?

I think it is better when some professionals deal with it, because maybe there are some technologies to hygienise that we cannot do ourselves. If there would be some centralized body that would deal with the wastes of all lodges this would be better and easier and for the lodges. Then, there is no additional time needed for taking care of the toilet and for the reuse.

Do you think this toilet has a chance to be established here, are they a good idea for the National Park?

Of course they are suitable. There is no smell, and so this is good.

What do you think is the biggest advantage of this toilet?

The main point is that there is no smell. This is good. Especially in the tourist business, we need good and nice toilets. Furthermore, it is economically efficient. We don't have to get water for the toilet, this is much less work. The idea considers both business (economical aspects) and environment at the same time, so this is good.

And what are the disadvantages?

I just saw this toilet for the first time, so I cannot say whether there are any disadvantages. Disadvantages will only get visible when one is actually using the toilet.

Are you planning to expand his camp?

Yes, I will build one more ger next year. However, my property is quite small, so I cannot expand in an unlimited way.

Is this camp open all year round?

No, it is only open only during the summer months. In Muren, I own the Turt Hotel and Pub – we are there in the winter.

Is this the first year that you are operating this camp?

Yes, this has opened up in 2007.

Are there any other points you would like to discuss?

Yeah, we also have problems with permafrost and water. We wanted to dig a very deep hole so we don't always have to empty (pump out) the pit, because this costs so much. But when we were digging, there was always water, so we couldn't make the holding tank as big as we wanted. So your toilet is good, because it is above the ground – then we don't have these problems.

What would be the necessary preconditions to build an ecosan toilet?

I will follow environmental inspector's standard, this is very important. Only if the environmental inspector gives this standard, can we build an ecosan toilet. If this standard changes, I'm even willing to exchange our flush toilets for ecosan toilets. I could still use the holding tank to store urine and excreta. So it is important that you meet the inspectors and the Governor of Khatgal to discuss these issues. I will support these toilets, I think the toilets are a good idea.



Why did you ask us to help you with your toilet (as you just built a new flush toilet)?

I really like the idea, because it is very economical and environmentally friendly, so if the environmental inspector says that it is OK that you can use them, I can change my current system. I would just need general cross section pictures – everything else, we could do ourselves, it is not so complicated to build.

## A 1.4 Khatgal Guesthouse

<u>Name of the camp:</u> Khatgal Guesthouse	<u>Location (Map) No.:</u> 6
<u>Name of camp owner:</u> Gerelee	<u>Name of interviewee:</u> Gerelee
<u>Capacity of the camp:</u> 10 tourists, 2 gers	<u>Existing since:</u> 2006
<u>Open through:</u> summer	<u>Current wastewater practice:</u> Pit latrine, unlined. Shower with greywater infiltration.
<u>Utilisation:</u> ca. 50	<u>Classification:</u> budget
<u>Interview date:</u> July 7 <sup>th</sup> , 2007	

KC (K. Conradin): Do you know anything about sanitation problems around the village?

**Mr. Gerelee:** There are many tourist camps, so this is maybe not good for nature. Especially if the camps are built very close to the water, this is problematic. Some of the tourist camps are also illegal and not adhering to the standards, so this is very bad for nature.

Did you have to get a permission to open this camp?

Yes, I got a of permission from the Ulaanbaatar Guesthouse association. However, I didn't get the official "stamp" yet, because that person dealing with it is very slow.

What do you think about the ecosan toilet, what is the best thing about it?

The best thing is that urine and faeces are separated. This is very good. If urine and faeces are mixed, it will not dry, and this is not good. If they are separated, this is very good for drying. This makes it much more hygienic.

Additionally, we don't have to dig a hole. This is also a big advantage. It is also easy to maintain. If the toilet gets full, I can easily change the container. It is also a big advantage over the conventional pit latrines – there, I have to dig a new pit every time. Maybe if we are using this toilet for a year or so, and this toilet is going well, and people can also see this, more people in Khatgal will want to have this toilet.

And what do you think is the biggest disadvantage?

I don't know.

If you build such a toilet, do you think you can reuse the urine for yourself, or should it be a centralized organisation that comes and picks up the urine and faeces and deals with them professionally?

I want to use it for just for my own advantage, e.g. trees. I can do this myself.

So what do you think is the best reuse option?

I don't know what is best, I heard a few things, but I can't really judge the opinions. But personally I think trees are a good option.

How much should this toilet cost?

I don't know the exact cost, I can only say this when I have built the toilet. I think I could invest between 300'000 and 400'000 Tugrik.

And do you think other measures to protect the environment are needed here?

The best thing would be that if tourists are travelling they are protecting the nature. They should travel in a responsible way and should not leave traces. Mongolians nowadays don't know how to protect nature. They [the Mongolians] might need some training and lectures. It would also be a good idea to inform them by using pictograms. It is very important to educate people. Communism still influences our thinking, and many people don't know about environmental protection. So the best thing would be to give them very good examples. The foreign tourists could be role models. I have seen many Mongolians who drink some water and then they just throw the waste out of the (car) window. But I have seen many foreign tourists who keep their plastic things. They are doing this better than Mongolians. In general, solid waste and solid waste management is a big problem.

Do you think this toilet have a chance to be established here?

You should give people very good information about nature and environment. If you give very good information and advice, and if you educate people properly, then maybe in the future they will build this toilet. Now they do not understand this, and didn't know about this concept before. But I think they should use it, and they will use it, if they are educated.

## A 1.5 Ashiai Ger Camp

<u>Name of the camp:</u> Ashiai	<u>Location (Map) No.:</u> 11
<u>Name of camp manager:</u> Mrs. Bayarjarhal	<u>Name of interviewee:</u> Mrs. Bayarjarhal
<u>Capacity of the camp:</u> 9 gers	<u>Existing Since:</u> 1998 (old camp). Under the current management, it was bought in 2006 and is operating since summer 2007.
<u>Open through:</u> July - September	<u>Current wastewater practice:</u> Flush toilet, shower, two blackwater holding tanks, 3 t and 10t
<u>Utilisation:</u> ?? (first year)	<u>Classification:</u> upmarket
<u>Interview date:</u> July 8 <sup>th</sup> , 2007	

*KC (K. Conradin): Are you aware of current sanitation problems around the lake?*

**Mrs. Bayarjarhal:** I don't really know about it, since I am relatively new in the area. However, just this year we built a flush new toilet with a holding tank, so it shouldn't influence the lake. Like this, we don't pollute the lake. We also collect all the solid waste on our camp ground. The solid waste is picked up by the garbage truck and brought to the central dumping place, so no pollution of the environment occurs here.

*What do you think of the waste dump?*

I don't really know much about this place, and, frankly speaking, I haven't given it any thought so far. I just know that the truck comes and picks up their blackwater and solid wastes.

*How is your current wastewater practice?*

We have two holding tanks, one 3 t, for blackwater, and one 10 t for the greywater from the showers. The truck for the wastewater costs 80'000 Tugrik every time. The tanks have to be emptied once every two weeks. This is of course an average; it depends on how many guests we have. The truck for the solid waste costs 20'000 Tugrik. The truck for the solid wastes comes irregularly, normally we wait until there is a truckload full of waste. I don't know the exact size of the solid waste truck, but it is quite a big truck.

We just recently rebuilt the toilet, so at the moment, it is not so attractive to us to build a new toilet. We invested about 2'000'000 Tugrik in our new toilet and shower – about half of this was for labour – but I don't really know this all so well. [There was a building and four flush toilets, but the building obviously was not newly built, so this amount does not reflect the total cost]

*What do you think are the biggest advantages of the no-mix ecosan toilet?*

Well, the most important thing is that it is very environmentally friendly. I think it is a very good and nice concept.

*And what do you think are the disadvantages?*

I am a little bit afraid that the tourists think that this toilet is not clean because it does not operate with water. Then, there might also be smell, and it is not so technically advanced.

*What are necessary preconditions for you to build an ecosan toilet?*

Well, of course the seats are necessary. Furthermore, the greywater problem is not dealt with. If the greywater is not dealt with, we still have to rely on the truck to take away the greywater. So this should be organised.

*How should the ecosan system be organised – could you do the maintenance yourselves, or should there be a professional service provider?*

Some professional service provider should be responsible for the maintenance and reuse. The thing is, if we have many tourists during the summer, we have no time to deal with the toilet, then we are very busy. So a professional person would be better

*What do you think is the best way to reuse the nutrients?*

I think trees are a good reuse option. But if possible, the fertilizer can also be used for vegetables. However, vegetables don't grow so well here.

## A 1.6 Dalaiban Ger Camp

<u>Name of the camp:</u> Dalaiban	<u>Location (Map) No.:</u> 7
<u>Name of camp manager:</u> Mr. Batsukh	<u>Name of interviewee:</u> Mr. Batsukh
<u>Capacity of the camp:</u> 10 gers	<u>Existing since:</u> 2007
<u>Open through:</u> summer and winter festival	<u>Current wastewater practice:</u> Flush toilet with 5'000 L blackwater holding tank, plus shower. Empties tank once a week, which costs 45'000 MNT.
<u>Utilisation:</u> Doesn't know.	<u>Classification:</u> upmarket middle
<u>Interview date:</u> July 8 <sup>th</sup> , 2007	

*KC (K. Conradin): Are you aware of sanitation problems around Lake Khuvsgul?*

**Mr. Batsukh:** Yes, but think that tourism camps are not involved in this. We empty our tank every week so it is not a problem, there is no infiltration. Also, for water is not a problem, because we can get as much water as we like from the lake, we don't have to save water. But the big problem is greywater. The tank fills up very quickly from the greywater. I think it doesn't make a difference whether things are separated or not, because this container doesn't fill because of faeces and urine, but because of greywater. So if we have some technology for the greywater, this would be a great idea. Otherwise, this whole issue is not so important for me.

*What do you think are the advantages of this ecosan no-mix toilet?*

I don't think there are any advantages. Separating makes no difference because these fractions are only a very small part of the total wastewater volume generated. It may be good for the wintertime – with the flush toilets, the pipes freeze and we cannot use it. It might also be an improvement for the worker's toilets.

*And what do you think are the disadvantages of this toilet?*

I think that the reuse should not be done individually. We cannot deal with this. People will not deal with the reuse properly, and then it will lead to more pollution. I think that it is not good that every toilet has its own collection tank for the faeces.

*So you think that the reuse and maintenance should be organised centrally?*

Yes, someone should arrange the reuse, we cannot deal with it on our own. This toilet could be a substitute for the worker's pit toilet, but we cannot use it for the tourists. I don't think it is comfortable enough, and maybe the tourists will not like it.

*What do you think about the ecosan concept?*

Well, I already know about these kinds of toilet – however, I think that the biggest part of the problem is the greywater, as it is the biggest fraction. We need a system to treat the greywater, this is our biggest problem. I know about systems in China where they use vacuum toilets and then a biogas plant, and then we reuse the gas for fire. I think this is funny [laughs].

*How much should this toilet cost maximally?*

Well, is there just one toilet or could several toilets be connected? And could the urine be collected in one central storage container? But the think is if we don't use water to flush, then the faeces cannot go into one container. Well, I can't say how much it should cost.

*What would be necessary preconditions for you to build such a toilet?*

It is important that this toilet should be accepted by inspectors, otherwise we cannot do it. I also think that there should be some economic gain from the reuse – if people separate and work for this toilet, then someone should eventually buy the fertilizer.

*What do you think is the best reuse concept?*

I think biogas systems are really good. If we use biogas for heating the water, then maybe lodges would be very interested. Then they can actually gain something from these toilets. But isn't there a lot of smell when we reuse the urine?

*Do you think that these toilets have a chance in the National Park once they are accepted by the inspector and if there is a centralised reuse service?*

I think that biogas would be very beneficial, because it has a clear economic advantage. If there are economic advantages from the ecosan toilet over conventional toilets, then the lodge owners would really like it. Biogas could be used for heating, and this would greatly reduce the amount of wood needed. This is an economic advantage.

But, I have to say this again, greywater treatment is very important. It would be very nice if we could solve this problem. This makes up the biggest part of the wastewater and thus causes the biggest part of the cost for the transport.

I don't agree that pathogens and nutrients can be infiltrated into the lake via groundwater. Nature, i.e., the soil filters the wastewater, so pathogens cannot infiltrate the water.

I have the following idea: I think that the pit toilet is good. The standard is that they have to be located at least 250 to 300 m away from the lake. Then I think that the pit toilet is safe. The liquid filters into the ground and is cleaned by plants. The solid part is retained in the pit and if we put ashes there to dry this is a good system. So we don't really need to change anything.

## A 1.7 Huvsgul Dalai Ger Camp

<u>Name of the camp:</u> Huvsgul Dalai Ger Camp	<u>Location (Map) No:</u> 9
<u>Name of camp manager:</u> Mrs. Buyankhishig	<u>Name of interviewee:</u> Mrs. Buyankhishig
<u>Capacity of the camp:</u> 17 gers	<u>Existing since:</u> 2000
<u>Open through:</u> June - September and winter festival	<u>Current wastewater practice:</u> Shower, flush toilet, and 10'000 L holding tank.
<u>Utilisation:</u> ca.500 tourists per year 200 domestic, 300 foreign.	<u>Classification:</u> upmarket middle
<u>Interview date:</u> July 8 <sup>th</sup> , 2007	

*KC (K. Conradin): Are you aware of sanitation problems around the lake?*

**Mrs. Buyankhishig:** There is a problem with wastewater that could potentially infiltrate the lake from the toilets, and there is a big problem with solid waste management. Both these wastes can eventually pollute the lake.

*What do you think about the dumping place?*

I don't like this waste dump. The tank carries the waste away from our place, but they are just dumped in some other place. Again, the wastes just get into the environment untreated. So eventually, the problem is just shifted to another place. I also think that solid waste should be separated from the other wastes, e.g. excreta.

*What do you think about the ecosan concept?*

I think it is a good idea for the worker's toilets. I would like to implement such a toilet for the staff. However, I am a bit worried that there might be some smell, so I am not so sure about implementing this for the tourists. Also what happens to the greywater in this system? The greywater is very important for us too.

*What do you think are the biggest advantages of this system?*

The first thing is that the toilet is easy to maintain. We can maintain this system by ourselves and don't have to rely on the wastewater truck. The wastewater truck is always problematic – sometimes it cannot come when we need it. Furthermore, it is environmentally friendly and has economic advantages. It's not good that the National Park sets up rules and regulations that we have to follow, which are not economically friendly at all. The flush toilet is very expensive for us! For the hygiene inspectors, the flush toilet with a holding tank and the lined pit toilet are the standards. However, the flush toilet is quite expensive to maintain, as we have to rely on the wastewater truck.

Furthermore, this system [the current one] is also not very suitable for the wintertime.

It would be a big advantage for us if we could manage and handle the wastes on our own and if we wouldn't have to wait for the wastewater truck.

*What do you think are the biggest disadvantages of this system?*

At the moment I cannot say whether there are any disadvantages. I will have to see this once the system is established. I would like to build such a toilet for the staff. I'm very happy that one of the problems that we have here is being tackled, and that somebody recognizes the problems with sanitation.

I also think that there should be a big central tank for the urine collection. The current system that you have in the pilot project toilet with the small urine tanks [canisters of 20 L] is a disadvantage; they need to be emptied very frequently

*What is your current wastewater system?:*

Currently we have a wastewater holding tank with a volume of 10'000 L. We have to empty this three times a month. Every emptying costs 50'000 Tugrik. However, I don't know where the wastewater goes eventually. In the cold season, we use the pit toilet, because the pipes of the flush toilets freeze.

*What are the necessary preconditions to build an ecosan toilet?*

The system should be agreed upon by the inspectors, and it should be standardized. Only then can we implement it, otherwise we will have troubles with the inspectors.

*How should the excreta be reused?*

I think that they can be reused both for trees and vegetables. Vegetables are also fine. Currently, Mongolia imports a lot of vegetables from China, and in China, I don't know whether the excreta are actually treated before they are reused as a fertilizer. It is also unclear what exactly they put on their fertilizer. [So knowing exactly that the excreta have been sanitized in a proper way and that they are safe to reuse makes the use of own excreta more attractive than eating the "polluted" Chinese vegetables.]

Last year, I also tried to grow some vegetables, but they did not grow – maybe it is too cold here. However, I think that it is absolutely fine to reuse the treated excreta for vegetables.

*How should the maintenance of the ecosan toilets be organised?*

I think that establishing a central collection and maintenance system will take a very long time. In cities, it could easily be centralized, but in this area it is difficult. So people should be responsible for their own reuse.

## A 1.8 Huvsgul Dul Ger Camp

<u>Name of the camp:</u> Huvsgul Dul Ger Camp	<u>Location (Map) No.:</u> 8
<u>Name of camp owner:</u> Mr. Purev	<u>Name of interviewee:</u> Mr. Purev
<u>Capacity of the camp:</u> 17 gers (max. ca. 85)	<u>Existing since:</u> 2003
<u>Open through:</u> June - September and winter festival	<u>Current wastewater practice:</u> Shower, flush toilet, sauna and 20'000 L holding tank.
<u>Utilisation:</u> roughly ca. 1000 tourists per year (700 domestic, 300 Foreign)	<u>Classification:</u> upmarket
<u>Interview date:</u> July 8 <sup>th</sup> , 2007	

*KC (K. Conradin): Are you aware of any problems with sanitation around Lake Khuvsugul?*

**Mr. Purev:** Yes. Especially the campsites pose serious problems. People who camp go to toilet everywhere, they don't dispose of solid wastes properly, and we are generally not very considerate and respectful to nature. This area is very sensitive, and this is a very big problem.

*What do you think of the current practice with a centralized dumping place?*

The dumping place is not good. It is not well separated from the environment. If there are heavy rains, everything is flushed to the river. So this is not good at all; it should be organised better. We should separate the different solid wastes (glass, plastic, paper), and then it should be recycled and taken care of properly. Also the fence around the dump is not good, it should be improved. We should build a better fence, and a very tall one. Furthermore, it should also have smaller holes so that the garbage doesn't get blown around. Additionally, this dump is located in a ditch, so wastes get easily washed away to the river. Maybe we should build some dams around this ditch to close it off better from the environment. If the dump is improved in such a way, then it could be used – but now, I am not very happy with it.

There is an American project going on. This organisation donated some big trucks that normally used in road construction to the National Park. However, these trucks are not used in the proper way (i.e., to collect solid wastes). We are used to build roads and to build the central hole in the dumping place. Furthermore, these trucks are also rented to people. These trucks are not used in the way we were meant to (i.e., to collect waste).

Today, the wastewater truck came here to his camp. We pay 60'000 Tugrik for one truckload. The truck has a capacity of 3 t. On average, we have to get this truck once in three weeks. If there are no tourists, we only need it once a month – but of course it depends on the number of tourists. In June, there were not many tourists, but now [beginning of July] it is filling up.

There is no control whether the truck really puts the wastes to this centralized dump. The truck driver just collects the money and then we don't know where the waste is dumped. Maybe he just dumps it anywhere.

*What do you think about this concept?*

It's a good concept; we can easily build it if we get the seats. The availability of these special seats is a limitation/obstacle for people to build it. If it is possible to produce these seats in Mongolia, this is great. We always use ashes for sanitising the excreta in the pit latrine, so we wouldn't have to change our behaviour for this.

*What are the advantages of this ecosan-no mix toilet / what do you like about it?*

I think it's a good concept [but he didn't specify any specific advantages]. I trust you that if you say that it is a good concept that it then really must be a good concept!

*And what are the disadvantages of this ecosan-no mix toilet?*

Maybe it is difficult to implement this concept for many people, or on a larger scale.

*How should the reuse be organised – should it be done individually or centralised?*

There should be several containers to carry out the wastes. A centralised organisation and maintenance service for many people would be better.

*What would be the best way to facilitate the reuse of the nutrients?*

If it would be possible here, the excreta could be used for agriculture, but as agriculture is very difficult here, it should be reused for trees. I think that vegetables are more difficult – it is difficult to eat our own excreta. I don't like the thought of putting excreta on my vegetables. We have a small greenhouse where we use animal dung for fertilizer. We grow cucumber, potatoes and tomatoes, but we are trying this the first time this year. There are also some cabbages for decoration, and we planted some wild onion. I think that vegetables cannot be grown well because of permafrost, so it is difficult to grow anything. We also dug a storage cellar, but there is always permafrost (in 70 cm depth). This storage room is very good to store vegetables and other products, it is a natural refrigerator.

*What other measures to protect the environment would you suggest?*

There are several rangers, but they cannot take care of all the areas, there are really not enough to take care of all this area. A good idea would be that every lodge, plus also local people get the responsibility for a certain area. Then, they should protect this specific area.

I am really concerned about the campsites. But also soil erosion and degradation through roads are a big problem. If the wastewater truck would not have to come to the camps so often, then there would also be less pressure on the road.

## A 1.9 Huvsgul Eco Tour Ger Camp

<u>Name of the camp:</u> Khuvs gul Eco Tour Ger Camp	<u>Location (Map) No.:</u> 10
<u>Name of camp owner:</u> Mr. Olfokh	<u>Name of interviewee:</u> Mr. Olfokh
<u>Capacity of the camp:</u> 18 gers 6 wooden houses	<u>Existing since:</u> 2001
<u>Open through:</u> summer & special occasions	<u>Current wastewater practice:</u> Flush toilet and shower, blackwater holding tank 6 t, for greywater 8 t. Pit toilet for workers and for wintertime winter
<u>Utilisation:</u> ca. 400 persons per year	<u>Classification:</u> middle upmarket
<u>Interview date:</u> July 8 <sup>th</sup> , 2007	

*KC (K. Conradin): What is your current sanitation practice?*

**Mr. Olfokh:** We have flush toilets with a blackwater holding tank of 6000 L, and we have a greywater holding tank with a volume of 8000 L. The emptying depends on how many guests there are, but usually has to be done once per week. The price for the emptying is between 50'000 and 60'000 Tugrik.

*Are you aware of sanitation problems around lake?*

No answer to this question.

*What do you think of the wastewater dump?*

It is not good to carry the wastewater away from here and just dump it to another place untreated. Like this, untreated waste gets into the environment. There should be stricter control and established standards on dumping. I have also heard that some waste is not dumped in the dump – some drivers just put it anywhere in the forest.

*What do you think about the ecosan toilet?*

I don't really know. I have heard of many kinds of toilet, but I have not used this toilet. So I cannot really say.

*What are the necessary preconditions for you to build such a toilet?*

It would easily be possible to build this toilet for the lodge, but only if there is a standard for this toilet by the environmental inspector. We also need a permission from the environmental inspector. If I get a cross section I can "improve" the toilet aesthetically, so that it looks very nice [Back then only a back view of the toilet was available because the front view could not be printed out, so from the back it does not look so nice.]

*What are the advantages of this ecosan-no mix toilet?*

I don't use a pit toilet but a flush toilet. However, in winter we cannot use the flush toilet because everything is frozen. Then, everybody, staff and tourists have to use the pit toilet. So this toilet would be very good for the wintertime. It is also possible to use this toilet in the wintertime, while flush toilets cannot be used in the wintertime. Furthermore, it is easy to maintain, don't have to rely on the wastewater truck.

*What are the disadvantages of this ecosan-no mix toilet?*

I think that the handling of the material is a disadvantage, there is much more maintenance than if we just have a flush toilet where it is emptied by the truck driver, or if we have a pit toilet. I also think there should be a bigger collection tank – then we wouldn't have to empty the urine tank so frequently. The manual handling of the excreta should be eliminated.

*How should the maintenance of these toilets be organised – individually or centralised?*

We can do the maintenance and reuse of the toilet ourselves, but we need the permission from the environmental inspectors. We can deal with the toilet ourselves and don't have to wait for the pick up truck, this is better. If we have a centralised maintenance, we have to rely on the truck again.

*How should the fertilizer best be reused?*

If vegetables would grow here, we could use it for vegetables. However, as it is too cold for vegetables, this is not possible here. However, I would accept vegetables. We eat a lot of Chinese vegetables and there is all kind of stuff on those, so reusing our own wastes would not be a problem. In Muren it would be possible to grow vegetables.

Trees would be a good reuse option in Khatgal.

*What other measures to protect the environment are necessary here?*

Well, there are so many problems here...

## A 1.10 Blue Pearl Ger Camp

<u>Name of the camp:</u> Blue Pearl Ger Camp	<u>Location (Map) No:</u> 13
<u>Name of camp manager:</u> Mrs. Selenge	<u>Name of interviewee:</u> Mrs. Selenge
<u>Capacity of the camp:</u> 100 tourists, 32 gers, 8 rooms	<u>Existing since:</u> 2003
<u>Open through:</u> June - September.	<u>Current wastewater practice:</u> Flush toilets and pit toilets for workers, with holding tank.
<u>Utilisation:</u> 200 foreign, 300 domestic	<u>Classification:</u> upmarket
<u>Interview date:</u> July 10 <sup>th</sup> , 2007	

*KC (K. Conradin): What is your current wastewater practice?*

**Mrs. Selenge:** We have flush toilets and showers and one blackwater holding tank with a volume of about four to five tons. It has to be emptied two to three times a month. One emptying service costs 50'000 to 60'000 Tugrik. The sewage is carried to the central dump in Khatgal. For the workers, we have just a normal (unlined) pit toilet. We currently employ 20 staff.

*Are you aware of any problems with sanitation around the lake?*

Currently we don't have any problems. We get the water from the lake by a pump, and this is fine. But sometimes it is a little difficult to get the waste carried away because we don't own our own wastewater truck – so we always have to rely on the few wastewater trucks available, this is not so nice.

*What do you think of the wastewater dump?*

If we carry our wastes away from the camp frequently, it is ok. But when we cannot find a wastewater truck, then it is a little bit difficult for us. Then we have to wait for the truck, and I think that the administration of Khatgal Soum should decrease the price of the truck. Then it would work better for us. Because sometimes we don't have any guests and thus no profit, and then this truck is very expensive for us.

*What do you think of this concept?*

We currently have to use these holding tanks, and at the moment the National Park doesn't allow us to use [unlined] pit toilets – but this one is lined, so it's good. Proper sanitation is very important and it is good that we can deal with this problem at once.

*What do you think is the biggest advantage?*

I think that every camp should have such toilets. The fertilizer aspect is very important. Then the camps could grow some sea buckthorn or animal fodder. Because, when all the workers use the flush toilets, it is very difficult for us. Our tank fills up very quickly and we have to hire the truck more and more, and then it will be very expensive. So the ecosan toilet would also have important economic advantages.

*What are the disadvantages of this toilet?*

I think this is a good kind of toilet and it has many advantages compared to the toilet we use now. You see, if we can separate, it will be an environmentally friendly. So there is nothing bad about this toilet. It has many advantages and is even profitable.

*How should the maintenance of these toilets be organised?*

I think that you should gather the owners of the camps and you should organise some kind of seminar. And you should also get some financial support to hire the special workers required to build this kind of toilet in every camp.

*So the seminar would also help to educate the people about this system?*

Yes, and in that case [in an official seminar or workshop] they will also believe this information.

*What do you think is the best way to reuse the fertilizer?*

I think that people should reuse this fertilizer for their vegetable gardens. And the camps should be engaged in growing vegetables themselves and use the fertilizer.

*And would you still eat these vegetables?*

Yes! You know we have Chinese vegetables and they all use such kinds of fertilizer. I saw this with my own eyes.

*Just the difference is that in China the fertilizer is often not treated in the right way...*

Yes...you know, it's much better than chemical fertilizer.

*We currently have our own little trial garden, but I think the climate is just too cold, the vegetables are still very small. We would need a proper greenhouse. But by the end of the summer we will know more...*

*Do you think if there is a standard for this toilet, do these toilets have a chance in the National Park, do you think they will be accepted?*

I think it will be accepted by people because it is not so expensive to build such kind of toilets. This locality is rich of wood, and there are many forests, and for this toilet we just need wood, and some kind of tank and the seat – so it is very easy to build.

*Are there any other measures that you would suggest to protect the environment here?*

Some road signs should be put up to educate local people and also foreign tourists to protect the nature and not to litter. They should always take their wastes with them. And I think that we should also educate the local residents. We should make them attend a special seminar about environmental protection – more education is needed.

## A 1.11 Nature's Door Ger Camp

<u>Name of the camp</u> : Nature's Door Ger Camp	<u>Location (Map) No.</u> : 14
<u>Name of camp manager</u> : Mrs. Otgonbayar	<u>Name of interviewee</u> : Mrs. Otgonbayar
<u>Capacity of the camp</u> : 18 gers, 80 tourists	<u>Existing since</u> : 1999
<u>Open through</u> : summer	<u>Current wastewater practice</u> : Composting toilets, compost not reused. Solar showers with holding tank.
<u>Utilisation</u> : 700 to 800 tourist per year	<u>Classification</u> : upmarket middle
<u>Interview date</u> : July 10 <sup>th</sup> , 2007	

*KC (K. Conradin): What is your current wastewater practice?*

**Mrs. Otgonbayar:** We have a composting toilet. We empty them once a year in September, and then the content is put on the central dump in Khatgal.

*So the compost is not reused for plants?*

No. We just empty it to the dump south of Khatgal. We don't know what happens there. It's just that the inspectors told us that we should empty it there, so we have to. They don't allow this compost to be reused.

*What do you think of the ecosan no-mix toilet?*

If we get this kind of seat, then we can easily build it. We don't have to change our system very much. I would change the system a little bit. If we separate both fractions, it will work very well. Now, our toilet smells a little bit – if we use the separation, this will be better.

*What do you like about the ecosan toilet? What do you think are the advantages?*

It protects the lake from pollution, this is the most important. With a flush toilet, the wastewater container is full very quickly, and tourist camps spend a lot of money to empty the holding tanks. But most of the camps don't empty them properly, so it is a big danger to the lake.

*If they don't empty their tanks, what happens?*

If they don't empty, both the greywater and the faeces infiltrate the soil and water and eventually go to the lake.

*What disadvantages does this ecosan toilet have?*

This toilet is very advantageous. I saw it in Austria and Germany. There are a lot of lakes like this, and there wasn't any pollution in the lake, because they decided to implement systems like this.

*So there is nothing that is maybe not so good about this toilet?*

No, nothing. But the hygiene inspectors don't understand this. The hygiene inspectors say: "Oh, this toilet is strange. And how can you do this, it requires a lot of maintenance work and is very old-fashioned. But then I say: "No, it isn't. I will develop and improve this system. Then I will be able to use it for one hundred years. This is much better than using a flush toilet and polluting the lake. But they still insist that it is strange." But I oppose them and say: "No. And when you go abroad, you will see this system. If you don't go abroad, of course you will never see it." I should improve our current toilet, now it is a little bit beginning to smell. And I am trying to do this, but I should improve this in your way. I saw this system with the separation of urine and faeces before but I couldn't imagine how to do it. Now I could do this easily, because I got this information from you. It is easy to change our system. All tourist camps should do this.

Otherwise, some of us are trying to prevent pollution and protect the lake, and others don't, and their excreta are just infiltrating through the ground. Like this, it doesn't work, and we cannot protect the lake. It needs a joint effort!

*Yes, that's true. If not everybody works together, then...*

Yes, so it is good. I support you and I am very glad that you came here.

*If you would build such a system and if you were allowed to reuse the recyclates, would you do that yourself or should there be a centralised organisation that deals with the reuse?*

I think there should be professionals. I know how to implement this system, but I don't know how to reuse properly, so I need professional support. If we make a mistake, it will be worse than the current situation. So if we have professionals, they do it in a professional way.

*What do you think is the best way to reuse the fertilizer?*

Right now, the local people's mental attitude is not prepared for this. So first maybe we should use it for growing trees and some things like that, and then maybe vegetables. If we reuse the fertilizer for vegetables, the local people will consider this very strange and unacceptable – although they are eating that kind of vegetables from China. However, they didn't see this, but they are eating them anyways. But if they will use and see that we reused excreta, then they will not like it. They are not ready to accept this yet.



Yes, but I think that is the same in many countries, even in Switzerland. If people don't know, then it's fine, but if they do then they will not want to eat these vegetables...

What about your warm water system, do you produce all your warm water with that system (solar powered)?

Yes, when it is sunny. When it is rainy, we usually heat the water by fire.

Is this system expensive?

No, in China it is not very expensive.

And how does it work?

There is water in the pipes and it is heated up.

Do you think if the inspector agrees with these toilets, do you think they will have a chance in the National Park? Will people accept them?

Yes, yes. If everybody use this system, it will be very good for Khatgal's drinking water. Not I am very worried about the tourist camps that are located near the Sukhbaatar Ships [near the port]. That is very close to the lake. And the people of Khatgal get their drinking water from the lake. Nevertheless, they use just the simple pit toilet with no protection against infiltration very close to the lake, sometimes only a few meters from the lake. The tourist camps also use holding tanks which are sometimes not emptied properly. This may result in more illnesses and stomach problems or similar things later, because this is not very good for the lake. The water from the lake does not move very much, there is only a limited exchange of water and the pollution accumulates. This is very dangerous, I think. I was born in Khatgal. That is why I always worry about drinking water and the cleanliness and purity of the lake. When I was young, we were skating on it and the water was so clear that I could see the fish through the ice. So we should continue to protect this lake for hundreds and hundreds of years.

So I always tell the hygiene inspectors when they come: "It is better to use the compost toilet. When it is a flush toilet, people use five or ten litres every time they flush it, and a 5 t container is full very easily. But they never empty their containers! So you don't have any control on where the wastewater is eventually going. How can you control this? How can you do this? Our system is much better!"

Last year, we had a lot of flooding here, and the groundwater level was raised. And the holding containers were lifted and their contents were just flowing into the lake. Also, when there is a lot of rain, we cannot cross the mountain [this ger camp is located further up the lake, and the road to there is very steep and inaccessible. When it rains, it becomes impossible to pass.] Then we cannot empty the dirty water to Khargana [name of the dump]. But I, with my compost toilet, I didn't have any problem. I just exchanged my containers when they were full, and put another empty container there. I just waited until the flood was gone, and then I had two full containers. And then I carried those two containers to the dump the flood is over. But those lodges with a holding tank couldn't carry away their wastes. The groundwater comes and lifts the containers up, and all just goes down into the lake. I saw this. So it is very dangerous. So our system is easy. If our container is full, we can easily exchange it and wait for the flood to pass, and when the flood finishes, we just carry our full containers to the dump, so we didn't have a problem.

Yes, if only the environmental inspectors would understand this...

I always try to persuade them. Also this year, the hygiene inspectors came here. I explained them: "Last year, all camps here were risking to pollute the lake. They couldn't do anything, because everything was flooded. I noticed, that our toilet worked very well. When my containers were full, I just replaced them by empty containers, and after the flood finished, I just carried two containers to the dump instead of one. I had no problem! I didn't have to be afraid that the groundwater level rose, I didn't have to worry about how I could clean my container. And also in the other camps areas, there were many problem and smell. I noticed I had the much better system. So if I improve the system a little bit like this [urine diverting] one, it will work very well. I know this. I have used the compost toilet for eight years and have not had a lot of problems. So I should do this separation. I always thought: about separation, but I couldn't find a solution.

Yes, and you should also go to the Bayangol guesthouse and find out how they did it with the seat. And I also hope that in the future some Mongolian manufacturer will start producing these separating seats. Now there is one in Ulaanbaatar, but they are quite expensive, so I hope there will be some cheaper ones in the future. This would make the things a lot easier.

Are there any other measures you would suggest to protect the environment in the National Park?

We have a garbage problem. One project is being implemented now. It is connected with Khovsgol Travel in Toilogt. They have an American partner institution, who donated a garbage truck to the National Park authorities protect the area, but the National Park didn't do much. So the project stopped again stopped. Now Khovsgol Travel has a contract with an individual man. That man collects the garbage every week. This is very good, because before it was smelly, and the nature was spoiled. They carry the wastes to Kharagana. In Kharagana, I don't know. Maybe in Kharagana there is the big problem now. A lot of garbage and a lot of wastewater from all the tourist camps is dumped there. But there, what is happening? I think we have a big problem there. They are dumping it there, without any fence, just in the open area, all wastes are blown everywhere.

Yes, they have a fence now, but it would be so much easier already if people would deal with their wastewater themselves right where they are.

And also when the hygiene inspectors come and they check me. They always say that they went to Kharagana, and that they didn't see any. Sawdust is added as a drying material to the compost toilets. [They take this as an indicator that she doesn't actually bring her compost to the dump, because they don't see the sawdust.] I tell them that it decomposes quickly. We put a lot of sawdust into our toilets, but it decomposes very quickly, it's not like

garbage. Still, they accuse me of lying, they never understand. They always start a big discussion with me and accuse me of not transporting my compost to the dump. But I reply that I am an honest person and a teacher, I teach in the academy. I tell them that I am an adult, and I am the owner of this camp, and that I don't want to lie to them. I say that they can give me a fine if they want. If they didn't see the compost, it doesn't matter – it just decomposes quickly!

An Australian forest manager came and explained me about forest management. He told me that there are many sick trees. Sick trees means that there are too many branches on one tree [maybe caused through damage caused by animals]. He told me that I need to cut the trees, otherwise they all cannot grow. But when we want to do this, then the National Park officers says that we cannot cut wood from the National Park protected area, and that we need to pay a big fine etc.

For the future, we need someone who can treat wood and who can manage the forest. In Mongolia, the forest management is not very well developed. Most professionals who are becoming forest managers haven't graduated yet. Some are maybe studying this, but there is nobody right now. I went with this Australian forest manager and he showed me many trees that needed some cutting and treatment. But... they [National Park authorities] don't know. So maybe someone should have a training session with National Park people. And also the staff who works in the National Park, they are not well educated people. They are neither educated in tourism nor in ecology, so they don't know. It is not their fault, but they need training how to do this work and how to protect this area. In that case, they will understand that, and then, it works. Then, partnership will be developed. Otherwise they don't know, and they will always say that this is a National Park and that you cannot do anything with forest management. Maybe after five or ten years the trees cannot grow, and maybe we will have all sick wood, so they should treat it. We need forest management.

What are other environmental problems?

Because there are a lot of vehicles and relatively good road access, people are now camping everywhere. And they put up their tents everywhere, they come with many jeeps. In the future, this will lead to increased damage in the nature.

In other countries I have not seen many people who are camping like in Mongolia. They camp, but they have special places, and also National Park inspectors. I have never seen this like here. Yesterday I went there [to a nearby campsite] – they camp anywhere! There were ten jeeps, ten or twenty tents, and the grass is all trampled down. I have seen a lot of cars with people that were camping. But the National Park is explaining that they have one man who is responsible for nature protection, the garbage collection and controlling. One such ranger should be responsible for one campsite. This man gets a salary from the National Park. But now, one man has established two gers and a guesthouse and one small house and a Guanz [a small restaurant]. They are working in a Guanz. So those who should protect the lake are using that land - he is just doing business! And that person should either do business or he should do the National Park job. He mustn't do both. This doesn't work. Like this, he loses all his authority over other people, because he himself is polluting the environment with his Guanz.

The campsite manager should do his job honestly, very strictly and in a responsible way. He is just taking land from the National Park. He should be responsible for the campsites, collect the garbage, organise things and educate people. But instead, he is polluting the environment himself. He is selling Hushuur [fried dumplings] and he just pours his wastewater into the forest. He doesn't have a holding tank. So a lot of flies are everywhere. And the people who are camping also just go to the forest to toilet. So the campsite manager should have a shovel and should at least cover the faeces. He should do his job. He shouldn't sell Hushuur and do business – he is in a responsible position!

That's why they call me a strange woman here. I always tell and explain them what they shouldn't do. National park people should do their job honestly and control very well who is doing what; who is emptying their dirty water where, who is trying to protect the nature, and who is collecting the garbage and who doesn't, who never supplies money for protecting the area.

Anyways, when they give permission to do this business, we have one page of guidelines. They tell us about which amount of money has to be spent for garbage management, which amount of money for wastewater systems, etc. So the National Park authorities should come and ask us how much we spent, what we you improved, how we did? They should ask us what works, and where we have some problems. They should work together with the lodge owners, not come and give a fine. They should come and ask where we have problems, and what kind of help do we need? If we need help, they should invite some kind of a professional and have meetings, seminars, and training. Their job would be this! They shouldn't just come in and stop and close and give fines.

Yes, they should be much more supporting and helping...

If I were the director of this National Park, I could do everything, a lot of things. But I am not that kind of business-woman, and I am also a teacher.

Oh, I think you would do a very good job...

Training is very important. We must educate the National Park people. Inspectors first, then through them we can educate the local people, and then tourist camps. Anyways, they should follow.... They are always looking for a good solution. How can we protect the nature, how can we stay in business for a longer time...? So they agree to this. The only thing is that the hygiene inspector and the National Park inspector don't understand this.

Yes, many lodges have said that this (ecosan) is a very good system, but the inspectors don't agree, so we cannot build it. I think this would be the most important thing to try to convince them.

And also the Garage 24, in our Guesthouse in Khatgal. There is BIWA lake project, a Japanese organisation, and from BIWA some researchers and scientists came and stayed in our guesthouse. They are researching the growth of forest and comparing different sites in Mongolia. They were also doing some scientific work. Now they are working on a greywater system. Garage 24 is doing this now. If it works, I will not have any problem. I will improve this [my toilet, I will install a UDD toilet], and I will have a greywater system, if the inspector agreed. They will believe the research that was done locally, and will see that wastewater and greywater are dealt with separately. In that case if they agree, this would be very good!

Yes, if the greywater treatment system was implemented as well, then we would need no trucks.

What system are you using in the Garage 24 Guesthouse?

I don't know very well. They built it in springtime when I was in Ulaanbaatar. There is also the address of the project who did it on a sign there. So they did a lot of work last spring, and now next year they will check again. Only the water from showers is going into this greywater garden. They also planted wood next to it. And the wood is growing now!

What kind of wood is it?

Larch. It's growing! It's really an eco-lodge. My camp is ecologically friendly!

Yes, I think you can say this...

Yes, so we will do this (ecosan) project and the Japanese [referring to the greywater treatment system] project. So, it's good! I like this!

## A 1.12 Toilogt Ger Camp

<u>Name of the camp:</u> Toilogt Ger Camp	<u>Location (Map) No.:</u> 12
<u>Name of camp owner:</u> Mr. Purevdorj	<u>Name of interviewee:</u> Mrs. Naranchimeg
<u>Capacity of the camp:</u> 100 tourists at same time. 20 gers, 10 Tepees	<u>Existing since:</u> 1991
<u>Open through:</u> May - September	<u>Current Wastewater Practice:</u> Flush toilet, shower, sauna, with holding tank. New system is planned.
<u>Utilisation:</u> 1500 tourists per year, both Mongolian and foreign.	<u>Classification:</u> upper upmarket
<u>Interview date:</u> July 10 <sup>th</sup> , 2007	

KC (K. Conradin): What is your current wastewater practice:

**Mrs. Naranchimeg:** There are eight showers in total, four for women and four for men. There is also a sauna plus eight flush toilets. The greywater and blackwater are collected together in a holding tank with a volume of 25 tons. If the camp is full, the wastewater truck has to come every day, otherwise about once every week or every two weeks. In May, it is enough to empty the tank once a month.

We have our own wastewater truck, so we just have to pay for the gasoline. The truck needs 60 L of gasoline for going to the Khatgal dump and coming back, so it costs about 55'000 Tugrik. The capacity of the truck is about 4 tons.

[Mr. Purevdorj, the owner of the Toilogt Ger Camp said in an earlier interview that he was not sure whether the waste was always carried to the Khatgal dump. He said that sometimes if the tank was emptied in the evening and driven to Khatgal during the night, the wastes were just dumped somewhere in the forest.]

Are there any problems with the current system, or is it working well?

We get our water from the lake, so getting the water is no problem. Just brining the wastewater away is problematic, because the gasoline costs a lot. The wastes are carried to Khatgal. So this system has some economic drawbacks because we have to pay so much for the gasoline.

What do you think about the current system of the central wastewater dump?

I know about this place. I asked the National Park officers what difference there was between dumping the wastes untreated into the nature there or in some other place. Our place is very far from Khatgal. I told them that maybe we could come up with a solution that the camps in Toilogt could jointly establish a cement-lined wastewater treatment plant [according to my understanding, a baffled reactor or a septic system] closer to Toilogt. I presented this solution to the National Park officers but they did not respond to this. So our wastes are still carried to the Khatgal dump. However, we are building this new system this summer. This system will be established by German engineers who will come to Toilogt by the end of July. We will not build new toilets, but the wastewater from the toilet will be treated in the wastewater treatment plant.

What do you think about the ecosan concept?

The toilets have to be built at least 300 m from the lake. There are the National Park's officers who come and give the standards and we must follow them. They also gave this standard with the wastewater holding tanks. However, this is no solution; the problems with wastewater are still not solved. Some people from the Aimag will come again around the 20<sup>th</sup> of July to get samples from the water and to check whether the standards are followed, and whether the systems are working well.

The ecosan toilet would be very efficient for camp sites. Maybe you have seen that on the way, there are many Mongolian people who are camping in the wild. Maybe you could do some research on the camping sites and implement ecosan toilets in the camp sites.

*If it would be a more sophisticated system, with less handling, what do you think are the biggest advantages of the ecosan toilet?*

It is economically advantageous, and there is no need for carrying the wastewater so far with a truck. However, this system must be accepted by the environmental inspectors and should meet the current standards. Also, there should be more research on the reuse. Is the reuse really efficient and beneficial for the plants? I have seen that on the camp sites, tourists just go to toilet anywhere, and then this area does not seem to be very nice. What will happen if we put a lot of wastes in one place? You should do some research about this and should find out whether it works under Mongolian conditions. [I explain that reuse must of course be done in a safe and controlled way.]

*What is the biggest disadvantage of the ecosan toilet with separation and reuse?*

The Nature's Door Ger Camp has a kind of an environmentally friendly toilet that you should go and see. [They have a compost toilet.] I think there should be someone who takes care of this toilet, because it is very difficult to do the reuse properly. It should be controlled and centrally organised.

When there are a lot of tourists, it will be difficult to use because we will have to empty the containers very frequently. [I explain again that this system can also be built with much bigger containers. Now, what we show them is a picture of the toilet at Khuvsgul Inn, where there are 25 L containers for easier handling of the urine.] Furthermore, also the greywater should be included in this system, as greywater constitutes a large volume. I think the system is very efficient for small guesthouses that only have a few tourist, but not for places with a lot of tourists.

*What is the best way to facilitate reuse?*

I think it would be best to reuse it for trees. I think the acceptance will be low if we recycles are used for sea buckthorn or vegetables. People do not like this, and they will say that it cannot be used for vegetables. You know, in China human wastes are used for agriculture, and we import these foods from China, but many people don't like that kind of food.

*If there is a standard for ecosan toilet, do you think people will implement more of these toilets in the National Park?*

Yes, if there is a standard, we can implement these system for the workers.

*What other measures to protect the environment would you suggest?*

There should be better solid waste management.

## A 1.13 Khuvsgul Inn

<u>Name of the camp:</u> Khuvsgul Inn Ger Camp	<u>Location (Map) No.:</u>
<u>Name of camp owner:</u> Mr. Chinbat	<u>Name of interviewee:</u> Mr. Chinbat
<u>Capacity of the camp:</u> 8 gers and 6 rooms	<u>Existing since:</u> 2006
<u>Open through:</u> June - September	<u>Current wastewater practice:</u> VIP toilet with cement lining, greywater holding tank, pit toilet for workers.
<u>Utilisation:</u> ca. 300 to 400	<u>Classification:</u> upmarket middle
<u>Interview date:</u> July 11th, 2007	

*KC (K. Conradin): Whose Idea was it to build this toilet here? Was it Kent's idea?*

**Mr. Chinbat:** Ah, yeah. It was Kent's idea.

*And why did you support it?*

I joined Kent's business in 1998. Then, at that time, tourism was just starting in Mongolia. We did business particularly in the northern part of Mongolia, mainly Khatgal and Renchinlume. And, you know, people use the regular Mongolian toilet (simple pit latrine) just everywhere, not only in Khatgal and Renchinlume, but in the cities too. Usually the customers – which are tourists – are uncomfortable with the Mongolian toilets, so we had to do something. So it was Kent's idea to build the no-mix toilet. We were talking about it, and I thought it was good. After that I went to America, and I saw the Romtec toilet [VIP toilet with an especially effective airflow to prevent smell] in a National Park and I thought: Hey, we can do that in Mongolia. And that's why I supported Kent.

*But the toilet you are now talking about was the old one...*

Yeah, but then Kent found the South African no-mix toilet on the internet... and you know that story. [Then some research was done and finally the no-mix toilet was built this summer in the Khuvsgul Inn.] And that's another good idea!

*And what do you like best about this new separating toilet?*

I like the separate toilet because the materials are cheap. You don't have to dig a hole, and there is no pumping. It easily separates the urine and the faeces, and it works. It is also good for the ecology. The problem is that there

are too many tourist camps, particularly the lake Khuvsgul area. And there are also the local people. The problem is that the regular toilets leak in the ground and the lake may eventually get polluted. That's why I like the separating toilet the best: They are simple, and useful, and ... great!

And what do you think ... well, you were thinking about infiltrating the urine at first, but I think this is a bit difficult because it is a big volume...

Oh, yeah yeah.

...and now, if we are reusing the urine, what do you think is best? To use it for trees, or for sea buckthorn, or...?

So, yeah. Well, the Mongolians are a nomadic people. We have never had ranches, and we have never grown potatoes and vegetables. Traditionally, we just eat meat, milk and flour products. I think the locals don't like the reuse aspect. I know that the urine and the faeces are good fertilizers, but the locals... My idea is that we have to explain the people that it is ok to use this fertilizer – the whole world is using it. But there will still be problems with acceptance from the local people's side. It will take a very long time to convince them, maybe it will take ten years or even more. The good thing is that we have started now – the main thing is that we have to do this stuff, so that other people can see it. Maybe ten years later everybody will understand it. That's my point!

That's good! Because... I think that many people are really interested, and they are arguing in your way that we have to start with the trees, and then maybe after a while...

...yes, they are interested. We should start with the trees. We are not eating trees – but we like them to look at!

...yes, and you use a lot firewood, and for construction, and so that's pretty good.

Yes, this aspect, and it is also good for the landscape .

Do you think that these toilets should be designed with a centralised pick-up and reuse system in the long run? Or do you think the lodges can just do the reuse themselves?

Well, in the big cities, there are sewer systems and pipes, but in the countryside, or in the ger districts, they don't have these systems. So there, it would be best to reuse it on site – but of course, this is a big project. So I think that reuse is best, but if this is not possible, you could also build one big dump. And then somebody should come and collect it and take it there.

You mean, if it's not possible to reuse the fertilizer?

Yes.

But my question is... if people build these separating toilets, should each lodge be responsible for their own reuse project, or should there be a wastewater truck that comes and picks up the urine and takes it to a centralised plantation? What do you think is better?

I think it's better if they reuse it themselves.

And do you think they will do this?

We need time. It will take time.

Do you think that if we get a standard for this toilets, if the hygiene inspectors agree to this toilet, do you think people will pick up on this idea in the National Park?

Some people will of course support the idea. And some people will realise that many Mongolians are poor. The toilet is not their number one problem; it's the food, their house, or gers, which are their number one problems. I think the wealthy people will of course support it, but the masses are poor, and that's a problem. I hope that in my country some day, people will have enough salary, that there will be enough labour.

Yes, and I think that the nicest idea would be that the value of the fertilizer is recognized. And that even if you are very poor, you could have this toilet. Somebody that has a business with fertilizer would come and pick up the urine would just pay you a little amount. For that person, the urine would be a resource that he or she can use.

Well, in central Mongolia, in Selenge and Bulgan, they have ranches. People are growing vegetables, and agriculture is a serious business. In this area here, it's too cold. There is a long spring and winter, and a short summer. The main incomes are herding and tourism. The fertilizer, I think, is not such a big issue here. We can try out with people who are interested, like tourist camp, or some business people, or the governor. Or we could just opt for fertilizing the trees. Trees are a wonderful idea.

Yes, I think trees are ... well, everything else doesn't really grow here. Something else: do you know the rough cost of this toilet?

It was about one Million Tugrik. They may have more accurate figures maybe in Ulaanbaatar.

What do you think about the central wastewater dump? Do you think that its good to collect wastes at one central point, or...

I saw that dump. It was not well organised, and nobody knew anything. The good thing now is that they are trying, they are collecting the garbage. But we need to figure out a better idea.

Are there any other ideas to protect the environment that you would suggest for the Khuvsgul area?

Yes - I totally support your idea and your project, it's pretty neat. We need to do something different. I think that the inspectors don't know which the right way is. There are too many rules, and some rules are not very good. And then the environmental inspectors and the rangers are telling me something different, and the inspectors are telling me something different. The Mongolian policies are not right. We need right policies. Your project, our toilet, may help to develop these policies. I want the report you will write, and we will translate it, and maybe you and me and Kent, we will go to the Mongolian government, and talk to them, some day....

Yes, I think we just need to establish a little network.

Yes, we need to establish the whole idea. And I really support your idea, and I hope we will succeed!

## A 1.14 Nature's Door Guesthouse

<u>Name of the camp:</u> Nature's Door Guesthouse	<u>Location (Map) No.:</u> 18
<u>Name of camp manager:</u> Mrs. Orkhon	<u>Name of Interviewee:</u> Mrs. Orkhon
<u>Capacity of the camp:</u> 20 to 30 tourists 4 gers and dorms	<u>Existing since:</u> 2001
<u>Open through:</u> June - October	<u>Current wastewater practice:</u> Compost toilets. Showers with a 5 t holding tank. This year, a greywater treatment system for shower water was tried out.
<u>Utilisation:</u> ca. 250 tourists per year	<u>Classification:</u> middle
<u>Interview date:</u> July 12th. 2007	

KC (K. Conradin): What is the current wastewater practice?

**Mrs. Orkhon:** Just this year, a new greywater system was built. It consists of a trench about 1 m wide, 6 m long and 0.6 m deep. This trench is filled with gravel, sand and stones of different sizes, and a bio-membrane. This system is being tried out this year and not fully implemented. If the results are good, we will use it next year, and if there is something we have to improve, we have to improve it first. If the results are continuously good over several years, this system could be implemented around the lake.

We currently also use a holding tank (5 t) for our greywater – at the moment, this greywater is brought to the central dump. Our toilets are compost toilets and don't need water.

We have our own wastewater truck, so the emptying costs around 54'000 MNT, just for the gasoline. We currently have to empty the greywater holding tank once every ten days.

Are you aware of problems with sanitation around the lake?

With this lodge, we don't have problems with sanitation, because we use compost toilets and we collect our solid waste in containers. So we don't have any problems. However, I am concerned about other lodges that are close to the lake; this is bad. For the greywater, we use a big holding tank; thus, we fulfil the standards. So I think it is no problem.

What do you think of this centralized wastewater dump?

I have never been there, so I don't know. But seeing that picture [we were showing a picture of it] it seems to be a very open [unprotected] place. There is one family responsible for the dump, and they hand out a receipt. So everybody who brings waste there is registered, so the National Park can control the process. If there is a company who for instance only brings waste once a month, they can judge whether this fits their capacity (or whether it is to be supposed that wastes are dumped illegally). In that case, they can give this company a fine.

What do you think about the ecosan concept?

It is a very good idea to implement such toilets. I support this idea. We are currently using the compost toilet, and we use some chemicals to decrease the smell. After we put the wastes in the nature, the grass and the ground is a little degraded, so maybe this is because of the chemicals.

What kind of chemicals?

I think the name is Choleraamin [??]. We also put sawdust.

So after you put these wastes into the nature the grass doesn't grow so well there?

Yes.

So if you say the grass doesn't grow so well, do you put it into the nature or to the central dump? I have heard from the Nature's Door Ger Camp that they have to bring their compost to the central dump...

Yes, we also bring it to the central dump.

But how did you notice then that the grass is not growing so well?

I just heard this from the drivers. They say the grass is not growing well, because a lot of waste is put there. So its not from our waste.

So it's not specifically your waste that hinders the grass from growing?

No, not specifically our, just in general. Because so much waste is put there, the plants don't grow so well in that location.

What is the biggest advantage of this toilet?

It is environmentally friendly and easy to build. It is also easier to maintain because there are small containers. Our compost toilet has very big containers and we empty the containers when they are not full, because otherwise they get too heavy.

What are the biggest disadvantages of this toilet?

I like it very much; I don't see any obvious disadvantages.

If we reuse the fertilizer from this toilet, which plants would be best to reuse the fertilizer?

We could use it for the trees within our fence [there is a little fenced off area near the toilet with some larches]. For agriculture, it is not possible here, because it is too cold.

How should the reuse of the fertilizer be organized? Should the lodges be responsible individually, or should there be a centralized organisation?

We could organise this. But I wouldn't like to reuse it within my fence. I would like that the urine/faeces are carried to the dump. Of course, then it can also be used by the nature and the plants there. The plants that grow there can take up the nutrients.

But you don't want to reuse it here?

No, I wouldn't like that.

But when we just carry the dried material to the dump, then it is not reused, the fertilizer is just wasted then. Would you accept it if the reuse was done in a central tree plantation, for instance?

Well, it is the National Park who gives this legislation. If we don't put our wastes there, we get a fine. So that's why I said that.

But if we could reuse it somewhere else, it would be ok?

Yes. Of course, there must be the environmental inspector's agreement and instructions and standards for the reuse. Because if we implement this toilet and we put the treated waste just anywhere, then we have to pay a fine.

Do you know more or less how much you paid to build this compost toilet?

I don't know well, but I guess it is cheaper than other toilets, because it just consists of wood and containers.

And what are the necessary preconditions so you would build one of these no-mix toilets?

There are no preconditions; we just need the environmental inspector's agreement. Our composting toilet has a little smell, so it would be good to improve it.

Yes, with a no-mix toilet the smell can be reduced. But a composting toilet is already a very big improvement to the flush systems.

What kind of support would be necessary for you so you could build such a toilet?

If our construction workers visit the Khuvsgul Inn and see the toilet and the cross section, then they could build and improve this toilet. We don't need much more support.

Do you think if this system is inspected by the environmental inspectors, will people start building such toilets in the National Park?

If we can show the people some results and if we can show them that it is friendly to the environment, then it can be implemented. Of course other lodges don't depend on the environmental inspectors if it is really friendly to the environment. We just show it to the environmental inspectors and then it will be accepted.

Are there any other measures to protect the environment that you would suggest for this area?

There are three things that I would like to suggest. Firstly: Some lodges are built very close to the lake. If this ecosan toilet is implemented in those places it could be very good. Secondly: There is solid waste everywhere in Khatgal. We should put up more dustbins; people could dispose of their wastes there. Some people just put their wastes into some ditch or hole, but when it is windy, all wastes are blown everywhere. Thirdly: Though the officers from National Park come to the lodges and control where they put solid wastes, they do not control the local people – it is not controlled where they put their wastes. This should be improved.

## A 1.15 North Port Ger Camp

<u>Name of the camp:</u> North Port Guest House	<u>Location (Map) No.:</u> 17
<u>Name of camp manager:</u> Mrs. Tserma	<u>Name of interviewee:</u> Mrs. Tserma
<u>Capacity of the camp:</u> 10 tourists	<u>Existing since:</u> built in 2006, running since this year
<u>Open through:</u> June - September	<u>Current wastewater practice:</u> Pit Toilet
<u>Utilisation:</u> ?? (first year)	<u>Classification:</u> Budget, mainly for Mongolians
<u>Interview date:</u> July 12 <sup>th</sup> , 2007	

KC (K. Conradin): What is your current wastewater practice:

**Mrs. Tserma:** We have a pit toilet that is used both by tourists and by the staff. Next year, there will be a flush toilet with a holding tank. It is actually already built but not in use yet. There is a 2 t holding tank. But the toilet is not connected to this holding tank [there will have to be another]. I cannot make any indications about use and emptying, as we only just opened.

Are you aware of any problems with sanitation around the lake?

Well, I know that camps should be built 300 m far away from the lake, but it is not possible for us [the ger camp is situated on a small stretch of land, which is only about 100 m wide, just between the road and the lake]. Mostly lodges are built very close to the water.

And why is this a problem, because of infiltration, or why?

The lodges are not concerned about the lake, and so it could be polluted from their wastes. But it's not only the lodges, the tourists are a very important source of pollution as well. They wash themselves with soap and they also clean other things in the lake or not far from the lake, and so this is a big problem for us, together with the unsolved waste problem.

What do you think about the current system with the wastewater dump?

I haven't been to this dump myself, but I heard that there is one central place. I don't know whether this is good or bad. From the picture, I see that there are no good standards or no barriers to prevent infiltration to the soil, but at least, the wastes are carried to a place that is far away, or further away than here. However, it is not good. It should be improved, at least that's what I can tell from this picture.

What do you think about the ecosan toilet?

It's not only useful for lodges, but also for gers and families. And it seems to be easy to implement.

What do you think is the biggest advantage of this toilet?

It is environmentally friendly. However, I am also concerned about the greywater. This toilet is easy to implement and good to deal with the excreta, but the greywater is a very big problem for us. The toilet is also easy to maintain. Furthermore, we can also use this toilet in wintertime – we cannot use flush toilets in the winter.

Yes, this is of course just the toilet part, but a full concept should also include the greywater.

And are there any disadvantages?

At the moment, I don't see any disadvantages. We can build this toilet from locally available material. I will visit Chinbat's lodge and see the toilet there myself. Then I can see how it is working and how it was constructed. I also want to build one of these toilets within my fence in Khatgal in my family home, so that we have a toilet that we can also use in the wintertime.

What are the necessary preconditions for you to build this toilet?

Of course, we need the environmental inspector's agreement. But I think that this toilet is very environmentally friendly and I think the environmental inspector will accept this toilet. So there is nothing, not very narrow preconditions. Just the seat is very important, everything else is locally available.

What should such a toilet cost?

I don't know... do you know the cost? If we use the prefabricated seat, it looks nicer, but it will be of course more expensive. I can't say.

If we reuse the human excreta as a fertilizer, how should the reuse be organized? Should there be a central organisation or should lodges be responsible for the maintenance individually?

I think we can maintain this toilet ourselves.

And what would be the best way to reuse the nutrients?

I think that we should just mix it with soil, and then bury it. We don't have any agriculture here. We can't use it for agriculture or vegetables, so we should just mix it with soil and bury it. This, we should of course only do once it is stored and safe.

Do you think this toilet will be accepted locally if the environmental inspectors agree?

Yes, they will like this toilet.

How much did you invest for your current toilet and shower?

I don't know exactly.

Are there any other measures to protect the environment that you would suggest for this area?

Most problems are related to the campsites. One person is responsible for the campsites, but they just get the money and don't do their work properly. And the National Park also gets money from the taxes and they just sit in their office. The rangers should walk around and control where people are camping, and where they put their wastes. They must do that but they don't. You should work with the camp sites. The camp sites are also a cause of soil erosion, because all drivers want to go as close to the lake as possible and they drive anywhere to reach the campsite. You must do research concerning the camp sites!

During the course of this interview, other people came in and also wanted to learn about this new project.

## A 1.16 Yerlug Ger Camp

<u>Name of the camp:</u> Yerlug Ger Camp	<u>Location (Map) No.:</u> 19
<u>Name of camp owner:</u> Mrs. Otgonbayar	<u>Name of interviewee:</u> Mrs. Otgonbayar
<u>Capacity of the camp:</u> 10 gers, 30 tourists	<u>Existing since:</u> 2006 building, 2007 running
<u>Open through:</u> Summer & winter festival	<u>Current wastewater practice:</u> Flush toilet, blackwater holding tank 8 t, pit toilet for workers, and also for Mongolian tourists
<u>Utilisation:</u> 140 tourists per year	<u>Classification:</u> middle upmarket
<u>Interview date:</u> July 12th, 2007	



The interviewee was very interested. She holds a MSc in Biology from the NUM in Ulaanbaatar.

*KC (K. Conradin): What is your current wastewater practice?*

**Mrs. Otgonbayar:** Currently, we have a flush toilet plus an 8 t holding tank. The Mongolian tourists can stay at a cheaper price and also use the pit toilet. We empty the holding tank once a month, and this costs about 40'000 to 60'000 Tugrik.

*Are you aware of problems with sanitation around Lake Khuvsgul?*

To build this camp, we made an environmental assessment. This means, that some inspectors evaluate the camp and tell us what measures we have to take in order to minimize the impact we have on the environment, or to restore the original conditions of the environment as closely as possible. The toilets have to be built at least 300 m far away from the lake. I am worried about the camps that are built very close to the lake, as this is a very sensitive area here. All camps use flush toilets here, and if they are built very close to the lake, then potential leakage could turn into a serious problem.

*What is your opinion on the dump?*

I think that it is built very close to Khatgal, but there is no other place where we can put our wastes. The dump should be improved. We should separate the solids from the wastewater, and there should be a waste separation, such as separate containers for glass, plastic, cotton, paper etc. This would facilitate the recycling of the wastes.

*What do you think about the ecosan toilet?*

I think it is environmentally friendly, but when can we see the benefits of this toilet?

*I guess the first benefit can be seen immediately – it doesn't smell like a pit toilet...*

My company organizes workshops and trainings for people about agriculture, so I know very well about the different fertilizers. There are chemical fertilizers, but we can also use bio-fertilizer, and of course for the bio-fertilizer, people mostly use animal dung. But of course, we can also use human excreta – but when do we know that it is safe?

*There are special regulations that have to be obeyed, and there is a whole book by the WHO that Classifications for every region and climate which procedures are necessary. Generally, in this climate, you have to wait at least one year until we can reuse the excreta as a fertilizer. But maybe it is still better if we don't put it immediately on vegetables, but on barley, or wheat, or things like this...*

Well, but in practical experience some Chinese imported foods are not good quality and not healthy. They contain high amounts of heavy metals and toxic substances and of course they use chemicals and artificial fertilizer. Another thing is that they use faeces ... and so how can we say that it is safe? Because we would with this system in China they use the human excreta as well.

*Well, there are many experiences that if we obey the guidelines, it is very safe to use. Plus, there is such a big need for fertilizer in many parts of the world that this fertilizer can also be used for non-food sources...*

It's just that because I am interested that I ask all this things. Of course we can use these toilets, and it is very good to protect the lake from pollution.

*And if we are talking about reuse, what do you think would be best to use it on?*

We can recycle it to nature. It is useful to use – but maybe people have some apprehensions about the maintenance of this toilet. I like the traditional custom that we should not pollute the origin of streams, and this tradition is very important to me. Of course people who lived a nomadic life, and built their pits outside and not close to the lake, of course it [our excreta] will decompose in nature. But now we are close to the lake, and we are concentrated here, and wastes are accumulating, and so it is good to use this [ecosan] toilet.

*And which products should it be used for?*

I would just like to put it into the nature (not exclusively for reuse). Just when it is safe, it can be mixed with some soil and then it can safely decompose there

*What are the biggest advantages of this toilet?*

If there are pit toilets, I want to get my drinking water further upstream. With this toilet, this is not necessary. So this toilet is protecting the lake. Furthermore, it goes with the Mongolian tradition of not polluting rivers and streams.

*What are the biggest disadvantages of this toilet?*

People might have apprehensions in handling and managing the excreta. Furthermore, I am afraid that the end product might not be safe.

*What are the necessary preconditions for you to build such a toilet?*

Of course we need the special seat. Otherwise, all things are locally available and we can build it ourselves, the construction is similar to a pit toilet.

*What was the cost of your current system?*

It was about 6 Mio. MNT for both the toilet and the showers together. This includes building, labour, seats etc.

*If we reuse the excreta, how should this be organised? Should there be a central organisation, or can the lodges to it themselves?*

Servicing in a professional way is better, then we can make sure everything is properly taken care of. If the servicing is cheaper than now, then everybody will want this system.

I think it would be cheaper, because if you don't need flush water, then the volume to be carried is much smaller...

What support would be necessary for you to build such a toilet?

We need the seats, otherwise the building is similar to a pit toilet and we can do that easily.

Are there any other measures to protect the environment that you would suggest for this area?

The camp must do an environmental assessment, and then the camp will have an environmental protection plan. Most camps follow these plans, this is important

What do mean by an environmental assessment?

An assessment means: If a new camp is built, we have to determine the impacts on the environment. We have to find out what restoration measures have to be done, because the camps do have an impact on the environment. So there are professional people that give some kind of plans what the lodge owners should do to restore the original conditions and minimize the impact on the environment. Lodge owners must then follow these recommendations.

In foreign countries, there are some cities that are very close to the lakes – is there pollutions from these cities?

Yes, there is. Even in Switzerland, wastewater treatment plants were only built in the last century, and before, there was a lot of pollution in the lakes.

And do you get the drinking water from these lakes?

Yes, we do. But now we have very good wastewater treatment plants and strong laws and regulations, and the drinking water that we get from the lake is also treated before it is used.

We shouldn't repeat the other countries' experiences.

Yes, and in so many parts of the world flush toilets create huge problems and pollution. And even in Bruxelles, the capital of the EU, they don't have functioning wastewater treatment plants, and rivers are very polluted. If a country gets a chance not to repeat these mistakes, this is very important.

When we are talking with other lodge owners, you should tell them not to repeat our experiences. Even as little as three years ago, there were no lodges very close to the lake. Now they are being built very fast. And of course they are investing money to build the camps. So this should be prohibited before they actually start building, otherwise the camps have a big financial loss, and it is more difficult to close a camp down than to prevent it from being built. That is important.

## A 1.17 Bonda Lake Guesthouse

<u>Name of the camp:</u> Bonda Lake	<u>Location (Map) No.:</u> 15
<u>Name of camp manager:</u> ??	<u>Name of interviewee:</u> Mrs. Bayardalai
<u>Capacity of the camp:</u> 5 gers, 21 tourists	<u>Existing since:</u> 2004
<u>Open through:</u> June - September	<u>Current wastewater practice:</u> Compost toilet, pit toilet for staff, shower and 2 t greywater holding tank
<u>Utilisation:</u> 900 per year	<u>Classification:</u> budget
<u>Interview date:</u> July 13th, 2007	

KC (K. Conradin): What is your current wastewater practice?

**Mrs. Bayardalai:** We have composting toilets, like at Nature's Doors Guesthouse, and showers. The water from the showers goes into a 2 t holding tank. Currently, we have to empty this three times a month. I am not exactly sure about the price that we pay. There is also a pit toilet for the workers.

Do you know anything about problems with sanitation around Lake Khuvsgul?

I think that it is not good that the lodges are so close to the lake. The lodges may have containers to keep the wastes separate from nature, they may still leak and infiltrate into the lake. There is also smell from these toilets. You know that the ecosystem functions in loops. Through evaporation, the bacteria can go into the air and can also eventually be transported into the lake.

What do you think about the central wastewater dump?

I have heard of this, but I haven't seen it. Of course our wastes should be carried away far from the lake. This is also a National Park. But I don't know well about the dump, I have just heard of this. If there is rain and flooding, the wastes will be carried into the Eg River, so this dump is not good.

What do you think about the ecosan concept?

I understand that the main thing is the separation. Of course the urine can be reused as a fertilizer, but for faeces, this is not possible. When it is dried, the viruses and bacteria die, because there is no condition so survive. But I think this is not possible and though the bacteria die, they will get back to live if the faeces are given to trees

because they will again get wet. So like this, again, diseases can spread. I think that only if there is some treatment or some special method to make the faeces safe, then it can be reused.

Explanation about drying, composting and reuse etc... So what do you think about this concept?

I think it can be implemented. You know, we have the composting toilet. So we would only need to make a little change and it would be very easy to switch to a separating system. But I would like to see results about this toilet first.

What do you think is the biggest advantage of this toilet?

I think the biggest advantage is that it is environmentally friendly. Furthermore, there is no need to dig a hole under the ground. It can be built entirely above the ground. Additionally, if we dig a hole, there is soil pollution due to the wastes. So this toilet is very environmentally friendly.

Of course, if we use the faeces and the urine as a fertilizer to plants, of course this is beneficial to nature, because things are recycled..

What do you think is the biggest disadvantage of this toilet?

I think it is possible that we can implement it. I don't think there are any disadvantages.

What are the necessary preconditions to build such a toilet?

I don't think there are any preconditions, because it is very environmentally friendly. But of course the environmental inspectors should accept this.

If we reuse the excreta, how should this be organised? Should there be a central organisation, or can the lodges to it themselves?

I think we can maintain it ourselves. If it is not only implemented at lodges and guesthouses, but if there are more people, and if also families implement this toilet, all families could do it themselves.

What would be the best way to facilitate the reuse?

We could use it for trees, but also other plants that have a similar system with the nutrient uptake like trees. But for vegetables, I don't think this will be accepted. I think it is a very narrow system [in ecosystem terms, directly put faeces on vegetables again before the nutrients are "processed" somewhere else]. I think we would need some special technology and clear regulations for the reuse of human excreta on vegetables or agriculture so that it is safe.

You mean a special technology to apply it or to treat it?

For application.

And you said trees and plants... what plants do you mean?

I think sea buckthorn or berry [fruit] trees could be used – they don't grow in the ground.

Why should there be a special technology for application for vegetables, so that the urine does not get into contact with the plants, or what?

No, I think it should be treated very well and then only it can be applied on vegetables.

So if it is used for vegetables, there should be a very good treatment.

Yes.

If there is a standard for this toilet, do you think people in the National Park will implement these toilets?

Yes, I think so.

How much did it cost to build the compost toilets, do you know this?

I don't know.

In your opinion, what would be the best way to facilitate a reuse of the nutrients contained in urine and faeces?

I think trees would be good. I think just in professional thinking, a flora has trees and bushes and plants and like that, so maybe we should mix different species and not only plant trees.

What other measures to protect the environment would you suggest for this area?

I am concerned about the solid waste. Because of the solid waste, pollution occurs in the environment. Then, plants may die. You know that the plants are the origin of the nutrient web, then if there are no plants, there is no food for the animals, and also for humans.

I am also interested in medicine plants, but many people destroy them because they think they are weed. I am interested in the protection of medicine plants. You know, my profession is plant protection. I studied in the agricultural university in Ulaanbaatar.

The main source of pollution are the Mongolian tourists. Two years ago, there were no camp sites. Everybody just camped where they wanted. Now it is a little more organised, but however, the tourists don't follow the rules.

## A 1.18 Sunway Guesthouse

<u>Name of the camp:</u> Sunway Guesthouse	<u>Location (Map) No.:</u> 22
<u>Name of camp owner:</u> Mr. Gansukh	<u>Name of interviewee:</u> Mr. Gansukh
<u>Capacity of the camp:</u> 3 gers, 15 tourists	<u>Existing Since:</u> 2001
<u>Open through:</u> June -September	<u>Current wastewater practice:</u> Pit latrine and shower (water is in filtrated into the ground).
<u>Utilisation:</u> 100 tourists per year	<u>Classification:</u> budget
<u>Interview date:</u> July 14th, 2007	

*KC (K. Conradin): What is your current wastewater practice?*

**Mr. Gansukh:** We have a pit toilet and a shower. Everybody, both the staff and the tourists, use the same toilet. The water from the shower is infiltrated into the ground.

*Are you aware of problems with sanitation around Lake Khuvsgul?*

We will change our toilet to a standard toilet with a holding tank. I have not heard about many problems with sanitation around the lake.

*Are you concerned about current practices in relation to sanitation and wastewater? Fact is that many camps around the lake collect wastewater in holding tanks. These tanks are emptied frequently – the content is just disposed of into the nature some 10 km south of Khatgal...?*

I have heard about the central dumping place, but I have not been there. We carry all our solid waste to the post office, from where it is carried to the dumping place.

*What do you think about the ecosan concept?*

I would be very much interested in building a new toilet next year. Especially for budget lodge owners, a flush toilet with a holding tank which has to be emptied frequently is a very high investment, so for those, an ecosan toilet would be a real alternative, especially from an economic point of view.

*What are the biggest advantages of the ecosan toilet?*

The biggest advantage is that it is environmentally friendly. Furthermore, there is no smell, and it is much better [more acceptable] for tourists. And it is also much cheaper than a flush toilet.

*What are the biggest disadvantages of the ecosan toilet?*

I think there is more labour required to maintain the toilet.

*What are necessary preconditions so that you would buy / build urine-separating toilets in your camp?*

There are no preconditions.

*What support would be necessary for you so you would introduce a urine-separating toilet?*

As this toilet is more expensive than a simple pit latrine, we would need some financial support to build this toilet. Otherwise, I can't say.

*If we reuse the excreta, how should this be organised? Should there be a central organisation, or can the lodges to it themselves?*

I think there should be a central service provider. I also think that our soils are very rich in nutrients, so here, there is no need for fertilizer. So it would be better if there is some professional organisation who deals with the reuse. Especially because people don't really need the fertilizer, there is a higher risk that it is not used properly, or just dumped somewhere.

*In your opinion, what would be the best way to facilitate a reuse of the nutrients contained in urine and faeces?*

I generally think that it is strange to use human excreta as a fertilizer, but trees and sea buckthorn would be ok, as we don't eat trees. Sea buckthorn is not in direct contact with the excreta, so it is ok as well.

*Do you think that people from here will embrace the idea of ecosan toilets if there is a standard for them?*

Yes, I'm sure. Acceptance will be very fast, mainly for economic reasons.

*What other measures to protect the environment would you suggest and support?*

Our main problem is sanitation. It causes many problems. So ecological sanitation is very important. Additionally, a main road should be built to prevent soil erosion.

# APPENDIX 2 TOURISTS' QUESTIONNAIRE

Questionnaire No: .....



I'm from the University of Basel, Switzerland. As part of my master's thesis, I'm investigating the acceptance of alternative wastewater management systems here in Khatgal. I'd be very grateful if you would take some time and answer my questions. Your answers will help to improve the infrastructure to protect the environment! Your answers will stay confidential.

**1. Are you aware of current sanitation problems around Lake Khuvsgul?**

1  yes      2  no

1.1. If yes, please specify briefly:

.....  
 .....

**2. Are you concerned about current practices in relation to sanitation and wastewater? Fact is that many camps around the lake collect wastewater in containers. These containers are emptied frequently – the content is just disposed of into the nature some 10 km south of Khatgal...**

1  yes      2  no      3  I don't know

2.1. Comments?

.....  
 .....

**3. How important is it to you that the lodge / camp you are staying at uses proper – meaning environmentally friendly – sanitation technologies?**

1  very important      2  important      3  medium importance      4  not important

**4. Would you be willing to pay more for a lodge that uses an environmentally friendly sanitation concept that deals with wastewater in a hygienic and safe way?**

1  yes      2  no

4.1. If yes, please specify roughly how much more you would be willing to pay? .....US\$/night

**5. Have you noticed the new no-mix toilet?**

1  yes      2  no

5.1. Did you use it?

1  yes      2  no

**6. How do you find the no-mix toilet in comparison to a regular (flush) toilet?**

→ *If you haven't used it, skip this question and cross the box beneath:*    4  not applicable

	better	no difference	worse
6.1. Design	1 <input type="checkbox"/>	2 <input type="checkbox"/>	3 <input type="checkbox"/>
6.2. Hygiene	1 <input type="checkbox"/>	2 <input type="checkbox"/>	3 <input type="checkbox"/>
6.3. Smell	1 <input type="checkbox"/>	2 <input type="checkbox"/>	3 <input type="checkbox"/>
6.4. User Comfort	1 <input type="checkbox"/>	2 <input type="checkbox"/>	3 <input type="checkbox"/>

**7. Did you know about the ideas behind the no-mix toilet before I told you about them?**

1  yes      2  no

7.1. What did you know? (please describe briefly)

.....  
 .....

**8. What do you think about this concept?**

- 1  good                      2  bad                      3  I don't know

8.1. Please explain your answer briefly:

.....  
 .....

**9. What do you think of the idea of introducing ecosan toilets to this area?**

- 1  good idea                      2  not a good idea                      3  I don't know

9.1. Why? (briefly justify your answer)

.....  
 .....

**10. In your view, what are the biggest advantages of the ecosan toilet in Khuvsgul Inn?**

.....  
 .....

**11. In your view, what are the biggest disadvantages of the ecosan toilet in Khuvsgul Inn?**

.....  
 .....

**12. Would you use/eat the following products that have been fertilized with treated/sanitised human urine/excreta?**

- 1  Wood from trees fertilized with sanitized human excreta  
 2  Meat / milk from animals which have eaten forage fertilized with sanitized human excreta  
 3  Agricultural products such as forage for animals, wheat, barley, corn etc.  
 4  Horticultural products, such as vegetables  
 5  Fruit from trees, berries, sea buckthorn

12.1. Comments (i.e., why would you / would you not eat/use a specific product):

.....  
 .....

**13. Would you support that ecosan toilets be made mandatory in National Parks within Mongolia?**

- 1  yes                      2  no                      3  don't know

13.1. Why do/don't you support it?

.....  
 .....

**14. What other measures to protect the environment would you suggest and support (e.g. by applying them personally)?**

.....  
 .....

**Personal Data**

15. Sex:                      1  male                      2  female

16. Age: .....

17. Nationality: .....



**Thank you very much for taking the time to answer these questions. Your answers are of course confidential. Enjoy the rest of your stay in Khatgal!** If you'd like, you can write down your email address on a list and I will send you the results.

## APPENDIX 3 QUESTIONNAIRE FOR LODGES

### A 3.1 Short Questionnaire for Lodges, Mongolian Version

#### АСУУЛГА

Таньд энэ өдрийн мэнд хүргэе.

Би Ариун цэврийн байгууламж буюу Бохирын системийн асуудлаар суралцдаг магистрын оюутан бөгөөд одоогоор Хөвсгөл нуурыг түшин үйл ажиллагаагаа явуулж буй жуулчны баазуудын байршлыг харуулсан газрын зураглал хийж байгаа.

Та дараах асуултуудын дагуу мэдээлэл өгч судалгааны ажилд маань тусална уу.

1. Жуулчны баазын нэр:
2. Эрхлэн явуулагчийн нэр:
3. Байгуулагдсан он сар өдөр:
4. Жуулчин хүлээж авах гэр, байшингийн тоо:
5. Жилд дунджаар хэдэн жуулчин авдаг вэ?
6. Ашиглаж буй жорлон:
  - a. Усан татуургатай жорлон
  - b. Үнс хэрэглэдэг хуурай жорлон
7. Ажилчдад зориулж монгол жорлон хэрэглэдэг үү?
8. Бохирын системдээ ёнкс хэрэглэдэг үү? Хэдийн багтаамжтай вэ?
9. Ёнкс дахь бохиروо хэр ойрхон соруулдаг вэ?
10. Ёнкс дох бохируо хэдэн төгрөгөөр соруулдаг вэ?

#### Short questionnaire for lodges, Mongolian version

An additional short questionnaire to collect quantitative data on the lodges (current wastewater management systems, year of establishment, utilisation etc.) was developed. This questionnaire was translated to Mongolian so that the author could work independently.

## A 3.2 Short Questionnaire for Lodges, English Translation

Dear Sir, dear Madam

I'm a geography student of Switzerland and am currently working on my master's thesis on more environmental alternatives for sanitation. You have surely already seen me. I am collecting some data on the lodges in the Khuvsgul area in general. If you have some time, I would be very happy if you can answer the following questions. Thank you!

- 1) Name of the lodge:
- 2) Name of the lodge owner:
- 3) Year of establishment:
- 4) Number of gers and buildings:
- 5) Average number of tourists per year:
- 6) Current toilet system
  - a) flush toilet
  - b) dry toilet
- 7) Is there additionally a pit toilet for the staff?
- 8) Do you have wastewater holding tanks? If yes, how big are they?
- 9) How often do you have to empty the wastewater holding tanks?
- 10) How much does the emptying cost?



## APPENDIX 4 COMMUNITY MEETING PARTICIPANTS

### A 4.1 Participants of the 1<sup>st</sup> Community Meeting, July 16<sup>th</sup>, 2007

Date: July 16<sup>th</sup>, 2007

Location: Sarnai Café, Khatgal

Moderators: B. Oyunmunkh, K. Conradin

No.	Name	Occupation	Age	Sex	Mapping:
1	Baasan, G.	retired	74	m	Campsite Map
2	Batmunkh, U.	unemployed	33	m	Campsite Map
3	Bayanjargal, G.	Hunter	62	m	Campsite Map
4	Bazarragchaa, Ch.	Retired	66	m	Campsite Map
5	Bold, A.	unemployed	43	m	Khatgal Map
6	Byambadorj, H.	Businesswoman	30	f	Khatgal Map
7	Dulmaa, D.	unemployed	43	f	Campsite Map
8	Enkhat, D.	unemployed	38	m	Khatgal Map
9	Enkhtaivan, D.	Ranger	47	m	Khatgal Map
10	Erdenejargal	Teacher	40	F	Campsite Map
11	Erdenetsooj, M.	Ranger	22	m	Campsite Map
12	Gerelee, B.	unemployed	43	f	Campsite Map
13	Nasanjargal, B.	Businesswoman	32	f	Khatgal Map
14	Otgonnyam, A.	Meteorologist	33	f	Khatgal Map
15	Tsetsegma	Watchman	48	f	Campsite Map
16	Tsevelmaa, B.	handicapped	44	f	Khatgal Map
17	Tsevelemaa, J.	teacher	45	f	Khatgal Map
18	Ulzijargal, B.	unemployed	37	f	Khatgal Map
19	Ulziikhishig, J.	unemployed	41	f	Khatgal Map

### A 4.2 Participants of the 2<sup>nd</sup> Community Meeting, July 17<sup>th</sup>, 2007

Date: July 17<sup>th</sup>, 2007

Location: Sarnai Café, Khatgal

Moderators: B. Oyunmunkh, K. Conradin

No.	Name	Occupation	Age	Sex
1	Batbayar, Ch.	Environmental Inspector	38	m
2	Bayanjargal	Hunter	62	m
3	Bazarragchaa, O.	retired	65	m
4	Bold, A.	unemployed	43	m
5	Byambadorj, U.	Businessman	29	m
6	Erdenetsooj	Ranger	22	m
7	Jargalsaikhan	unemployed	42	f
8	Khulganaa, G.	National Park Employee	27	f
9	Kranchimeg	Cook	20	m

APPENDIX 4 – COMMUNITY MEETING PARTICIPANTS

---

10	Narandelger, N.	Carpenter	31	m
11	Narantungalag, B.	unemployed	40	f
12	Ryenchinmyadag	retired	63	m
13	Ulzijjargal, B.	unemployed	38	f
14	Zolzaya, B.	Student	15	f

## APPENDIX 5 GREEN FUTURE REFORESTATION PROJECT

### A 5.1 Information Letter for Tourists



#### Dear Khatgal visitor

Are you enjoying the “Blue Pearl” and the pristine nature around it? Maybe you have realized that this remote paradise is under pressure. The countless logged trees around Khatgal and other place around the lake exemplify this. **If you are interested in preserving the nature here in northern Mongolia, please read on. You can help us with our planned reforestation project!**

We, Jacqueline and Katharina, are two Swiss Master students doing research in Khatgal and Toilogt. We installed a pilot project in ecological sanitation and perform a thorough environmental assessment. Our toilet doesn't need water and separates urine and faeces, through its special design, it allows to produce a hygienic and valuable fertilizer from what we commonly consider waste. This concept is called ecological sanitation, or ecosan. Ecosan returns the nutrients we excrete to the soil, where they come from. Because the climate in Khatgal is too cold for gardens and crops, planting trees is one of the most useful options bring these nutrients back to nature. Wood is used widely for construction and heating – and is not growing as fast as it is used.

Local people are very happy about the project, firstly because they care about nature, and secondly, because the project creates work for some of the many unemployed. The project “Green Future” is supported and approved by the Khatgal Governor Mr. Batbilguun and the head of the national park, Mr. Lhagvadorj. However, neither the village of Khatgal nor the Khuvsgul National Park can support the project financially.

This is the reason why we are approaching you. Especially in its starting phase, the project needs funds for the infrastructure like fences to protect the young larch trees from livestock and car drivers, or a low tech greenhouse where the larch seedlings are. Of course, also the workers need to be paid.

**Now it's up to you!** Are you interested in sponsoring a tree? For just 10 Dollars, Euros or 10'000 Tugrik, you'll receive a certificate and can help to protect the environment you are enjoying. Just ask your guesthouse manager. He or she is informed and can give you a certificate for your donation. Of course we are very happy if someone wants to give a little more than the necessary 10 Dollars for a tree...

When we get back to functioning internets, we plan to make a blog where you can get news about “your trees” and the project.

More questions about the reforestation project or the ecosan toilets? Just come and visit us in the “Khuvsgul Inn” near MS Guesthouse. We stay there all summer. You will find us in the morning and in the evenings when we are not doing fieldwork... :-)

**Thank you for your help and interest!**

Jacqueline von Arx and Katharina Conradin

*Jacqueline von Arx*

*K. Conradi*

[Jacqueline.vonax@gmail.com](mailto:Jacqueline.vonax@gmail.com), [k.conradin@gmail.com](mailto:k.conradin@gmail.com)

## A 5.2 Project Information

Many tourists and personal friends of the author and Jacqueline von Arx could be convinced to contribute to this project. After almost two months of fundraising (mainly J. von Arx), funds for more than one hundred trees were collected. In cooperation with the local administration and the National Park representatives, a suitable site was selected, not too far from the village and relatively close to the airport (see Map 5, p. 55). This area has been deforested in the 1960; since then, the village faces a lot more winds and dust storms. At the end of August, a fence was constructed by local workers to protect the trees from livestock and car drivers. A total 109 larches were planted on an area of roughly 800 m<sup>2</sup> in the beginning of September with the aid of a local ranger, Mr. Erdenetsooj.



Photo: J. VON ARX

**Forests are dominated by logging, young-growth trees are lacking.**



Photo: K. CONRADIN

**Construction of a fence to protect the young trees from livestock and car drivers.**



Photo: J. VON ARX

**Holes were dug for the new trees; like this, rainwater can collect in the swales.**



Photo: J. VON ARX

**Newly planted larches at the beginning of September.**



Photo: J. VON ARX

**Entrance to the plantation site.**