

Spring Catchment

Christian Meuli, Karl Wehrle



First edition: 2001, 1000 copies

Author: Christian Meuli, Karl Wehrle

Illustrations: Markus Mächler

Photos: Karl Wehrle, Christian Meuli, Jens Vad

Published by: SKAT, Swiss Centre for Development Cooperation
in Technology and Management

Layout: SKAT

Copyright: © SKAT, 2001

Comments: Please send any comments concerning this publication to:
SKAT
Vadianstrasse 42
CH-9000 St.Gallen, Switzerland
Tel: +41 71 228 54 54
Fax: +41 71 228 54 55
e-mail: info@skat.ch

Printed by: Niedermann AG, St.Gallen, Switzerland

ISBN: 3-908001-96-X

Context

Access to adequate water, sanitation, drainage and solid waste disposal are four inter-related basic needs which impact significantly on socio-economic development and quality of life. The number of people around the world who still do not have access to these basic facilities, despite enormous global effort over more than two decades, provides sufficient evidence that conventional approaches and solutions alone are unable to make a sufficient dent in the service backlog which still exists. Numerous initiatives are ongoing at different levels to improve strategies, technologies, institutional arrangements, socio-cultural anchorage, and cost effectiveness, all to enhance efficiency and, eventually, to have an impact on the sector's goals. In addition, the ever-increasing scarcity of water brings policymakers together to find solutions to the challenge of water resource management. This series of manuals is intended as a contribution to these efforts.

Background

The decision to produce this series of manuals was prompted by the positive experience gained with a practical manual based on the experience of Helvetas (a Swiss NGO) during the 1970s in Cameroon, which has become outdated with the passage of time. SDC (the Swiss Agency for Development and Co-operation) supported SKAT's initiative to produce this series, working with professionals with longstanding practical experience in the implementation of rural water supply projects. Lessons learnt during the workshops held by AGUASAN (an interdisciplinary working group of water and sanitation professionals from Swiss development and research organisations) over the last 14 years have been included where appropriate. In particular, there is an emphasis on documenting and illustrating practical experiences from all regions of the world.

The Manuals

As can be seen from the table on the back cover, this series of manuals is primarily aimed at project managers, engineers and technicians. However, given the wide range of subjects covered, it is also an important working tool for all actors in the sector, ranging from those involved with policy development to those constructing systems at village level. The series has a clear focus on water supply in rural settings. It proposes technologies with due consideration for socio-cultural, economic, institutional and regulatory requirements. This approach is in keeping with the SDC water and sanitation policy, emphasising the balanced development approach leading to sustainable programmes and projects.

It should be noted that the present series deals almost exclusively with water supply. The importance of sanitation is however clearly established in Volume 1, which deals predominantly with the software aspects necessary to achieve an impact. It includes some proposals for optional tools, approaches and institutional arrangements and is intended as an overall introduction to the other, more technical, volumes of the series.

Some final comments

The water and sanitation sector is constantly evolving. We would welcome any queries, comments or suggestions you might have. Your feedback will be made available to other interested users of the manuals.

Finally, we hope that these manuals will be useful for the practitioner in the field as well as for the planner in the office. If the series can be a contribution to providing water to more people in need on a sustainable basis, we will have achieved our goal.

The production of this series has only been possible through the continuous support of colleagues from all over the world. Our sincere thanks to all of them.

| | | |
|-----------|---|-----------|
| 1. | <i>Introduction</i> | 1 |
| 2. | <i>Principles</i> | 3 |
| 2.0 | General remarks | 4 |
| 2.1 | Origin and formation of springs | 4 |
| 2.2 | The different types of springs | 5 |
| 2.2.1 | The geological categories | 5 |
| 2.2.2 | The hydraulic categories | 6 |
| 2.3 | Water quality | 6 |
| 2.4 | Water quantity | 7 |
| 3. | <i>Preparatory Investigations</i> | 9 |
| 3.0 | General remarks | 10 |
| 3.1 | Tracing for springs | 10 |
| 3.2 | Preliminary observation at the spring site | 11 |
| 3.2.1 | Legal Rights | 11 |
| 3.2.2 | Altitude | 11 |
| 3.2.3 | Spring water quality | 11 |
| 3.2.4 | Water quantity | 13 |
| 3.3 | Water quality testing | 14 |
| 3.3.1 | Introduction | 14 |
| 3.3.2 | Basic quality requirements and analysing methods | 15 |
| 3.3.3 | Testing without equipment | 15 |
| 3.3.4 | Testing with equipment | 16 |
| 3.4 | Measuring the spring flow | 16 |
| 3.4.1 | Simple bucket method | 16 |
| 3.4.2 | Other methods | 16 |
| 3.5 | Balancing the spring flow with the water demand | 17 |
| 4. | <i>Selection of suitable spring</i> | 19 |
| 4.0 | General Remark | 20 |
| 4.1 | Sequences of selection process | 20 |
| 4.2 | Remedial measures for insufficient springs | 21 |
| 5. | <i>Design and construction of a spring catchment</i> | 23 |
| 5.0 | General remarks | 24 |
| 5.1 | The protection zone | 24 |
| 5.2 | Gravity spring catchments | 25 |
| 5.2.0 | General remarks | 25 |
| 5.2.1 | The different phases of construction | 26 |
| 5.2.2 | Excavation | 27 |

| | | |
|-----------|--|-----------|
| 5.2.3 | Design and Construction | 30 |
| 5.2.4 | The barrage | 30 |
| 5.2.5 | The permeable construction | 31 |
| 5.2.5.1 | Dry stone filterpackage..... | 31 |
| 5.2.5.2 | Perforated pipe | 32 |
| 5.2.6 | The cover of the catchment | 32 |
| 5.2.7 | Refilling of the earth cover | 32 |
| 5.3 | Artesian spring catchment | 32 |
| 5.3.0 | General remarks | 32 |
| 5.3.1 | Artesian spring from solid ground | 32 |
| 5.3.1.1 | Excavation..... | 33 |
| 5.3.1.2 | Design and construction of the catchment | 33 |
| 5.3.1.3 | The barrage | 34 |
| 5.3.1.4 | The permeable construction | 34 |
| 5.3.1.5 | The covering of the catchment..... | 34 |
| 5.3.1.6 | The refilling of the earth cover | 35 |
| 5.3.2 | Artesian spring from loose ground | 35 |
| 5.3.2.1 | Design and construction | 35 |
| 5.4 | The supply pipe | 37 |
| 5.4.0 | General remarks | 37 |
| 5.4.1 | Design criteria | 37 |
| 5.4.2 | Installation | 38 |
| 6. | <i>The spring chamber</i> | 39 |
| 6.0 | General remarks | 40 |
| 6.1 | Design criteria | 40 |
| 6.2 | Sedimentation | 41 |
| 6.3 | Designing the size of the water basin | 41 |
| 6.3.1 | Calculation of the required dimensions | 41 |
| 6.3.2 | Design Criteria | 42 |
| 6.4 | The different types of spring chambers | 42 |
| 6.4.1 | The simple inspection chamber | 42 |
| 6.4.2 | The advanced inspection chamber | 43 |
| 6.4.3 | The water point | 44 |
| 6.4.4 | The inspection manhole at the catchment | 46 |
| 7. | <i>Common mistakes made on spring catchments.....</i> | 47 |
| 7.0 | Twenty Common mistakes made on spring catchments | 48 |
| 8. | <i>Operation and Maintenance.....</i> | 49 |
| 9. | <i>Annexes</i> | 51 |
| 9.0 | Reference Books and useful websites | 52 |



Water: A precious good

1.0 Introduction

When underground water makes its way to the earth's surface and emerges as small water holes or wet spots, this feature is referred to either as a spring or as surface seepage. The preferred term depends on the volume of the flow observed; any natural surface discharge large enough to flow in a small rivulet can be called a spring, whereas lesser discharges are considered as surface seepage.

Few manifestations of ground water have held more popular interest than springs. Springs were largely responsible for determining the sites of ancient settlements. In many cultures, springs (and in particular their rising points) are highly respected as a kind of sacred spot or as a dwelling place of spirits. This attitude and belief towards springs needs to be carefully considered when constructing a spring catchment.

Springs can be classified in a number of ways. The classification can be based on magnitude of discharge, type of aquifer, chemical characteristics, water temperature, direction of water migration, relation to topography, and associated geological structures. It is important to note that the topographical basin and the system of surface drainage through streams or rivulets does not necessarily correspond with the hydrological underground spring water system.

The purpose of this manual is to present the reader with updated information on how to build and operate a good spring catchment. However, several thousand technical briefs would be required to cover every possible permutation of the many factors that serve to classify a spring. In practice, no spring is like any other, and therefore guidance in the form of basic principles can only be presented here. The information contained in this manual should be considered and then adapted to suite the specifics of each setting where a spring is located.

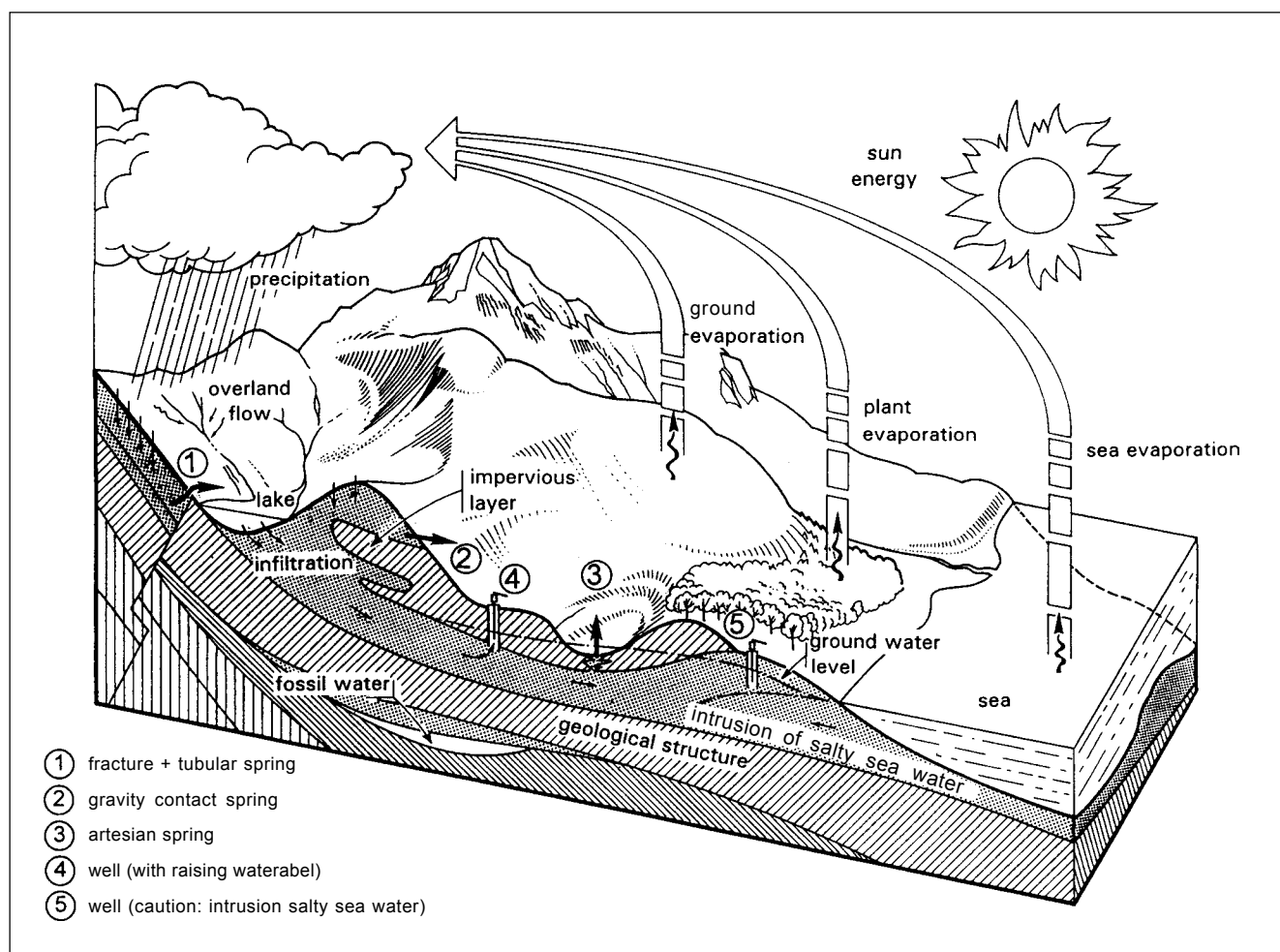

Fig. 1



Mountain slide spring

2.0 General remarks

This chapter provides some theoretical background about the origin and nature of springs. To design and construct a good spring catchment, it is necessary to have some understanding of what occurs behind the visible rising point of a spring.

2.1 Origin and formation of springs

Spring water originates normally from that part of rain-water which infiltrates into the soil and seeps through the permeable layer. The water seeps down until it meets with an impervious layer of material like clay or rock that prevents it from flowing deeper downwards into the ground. At those places where the impervious layer reaches the surface, the groundwater flow is

forced to the surface and forms a spring. The outflow may be at one spot only (such as at a rock fissure) or along the length of a layer such as a gravelbed. The water flows freely under gravity (gravity type), or under pressure from below (artesian type). The yield of different springs varies, from the gentle dripping at a small spring to the strong flow of large quantities of water at a bigger spring.

Spring water quality and quantity depend on the following factors:

- (a) The annual rainfall pattern
- (b) The size and geological formation of the intake area
- (c) The nature and slope of the surface onto which the rainwater falls
- (d) The thickness and nature of the covering stratum
- (e) The thickness and nature of the water bearing layer

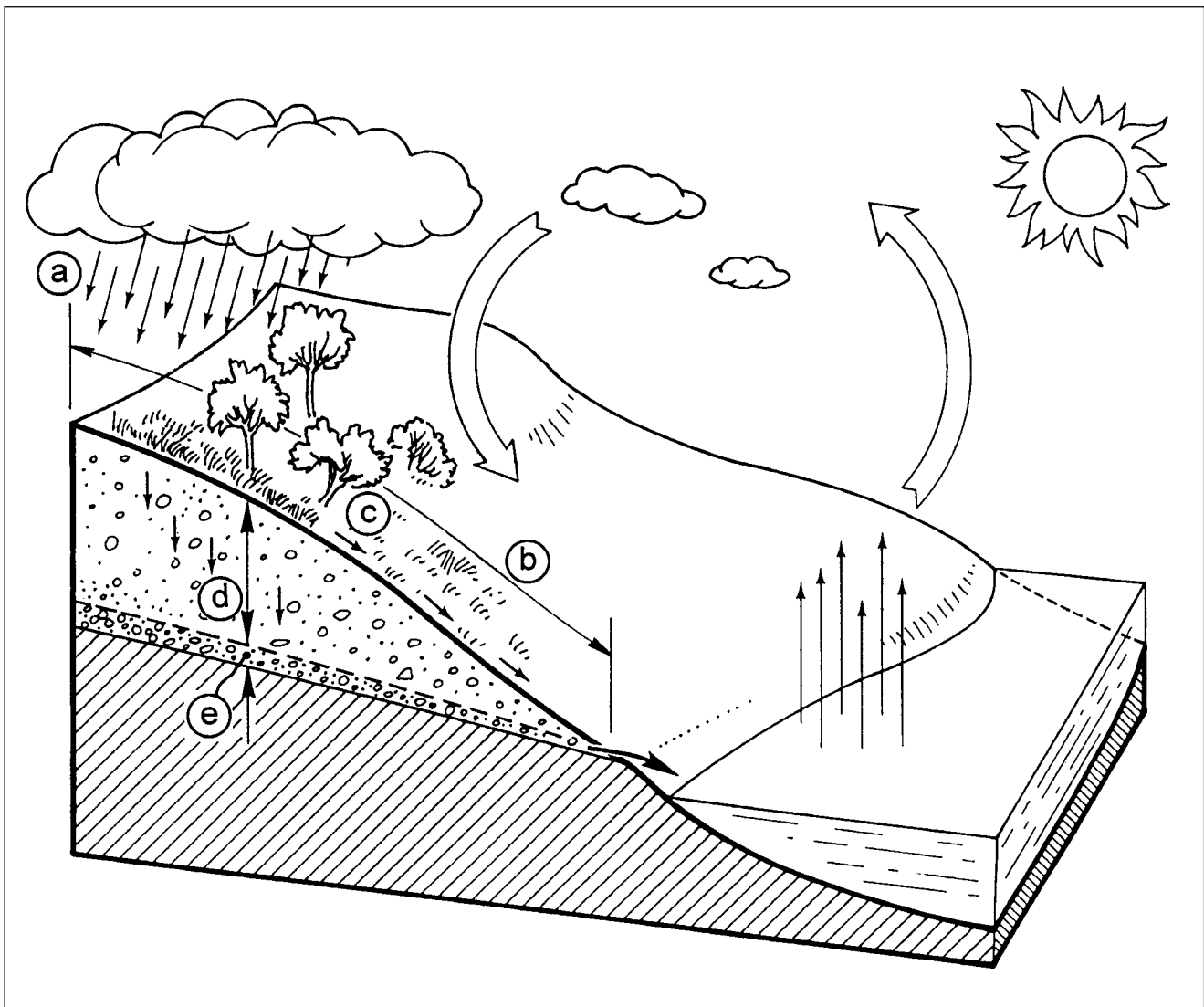

Fig. 2

2.2 The different types of springs

As mentioned in the introduction, there are several different methods for classifying springs. The most common categories are described in the following sections:

2.2.1 The geological categories

According to the geological nature of the spring area the most common types are (see also Fig. 1):

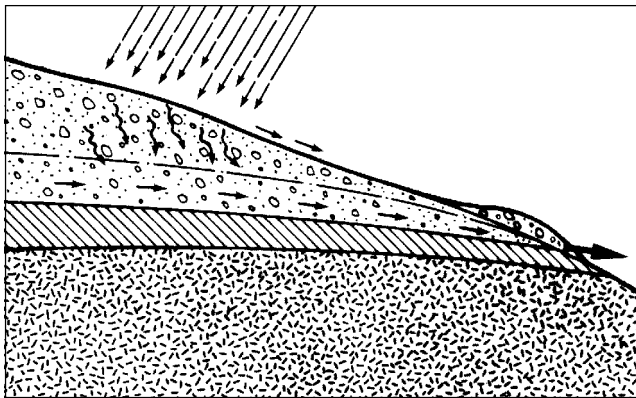

Fig. 3

Gravity contact spring:

These are springs formed when downward movement of underground water is restricted by an impervious underground layer and the water is forced to the surface.

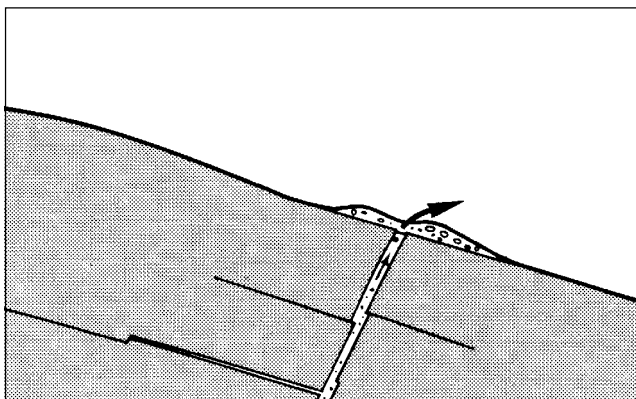

Fig. 4

Fracture and tubular spring:

These springs are formed when water comes to the surface through fractures or joints.

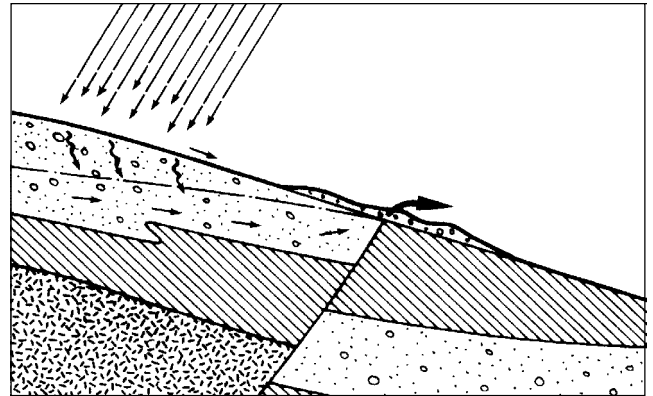

Fig. 5

Back-stowing spring:

These springs are formed by an impervious stratum that comes to the surface and therefore blocks the water from flowing downwards.

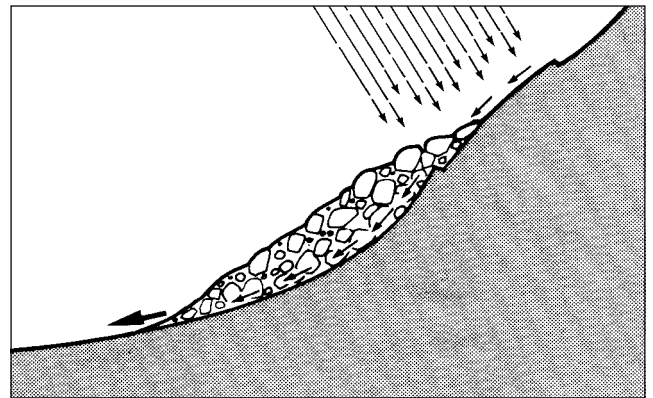

Fig. 6

Mountain slide spring:

These springs occur where water disappears into loose rock formations higher up and flows out to the surface at the bottom.

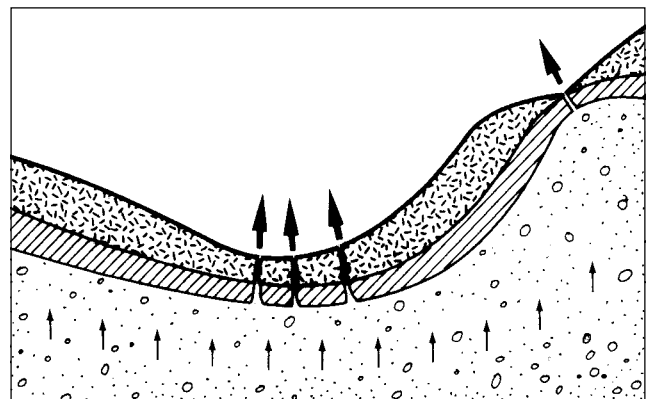

Fig. 7

Artesian springs:

These types of springs occur where groundwater is pressurised between two impermeable layers. In artesian type springs the water reaches the surface because it is pushed under pressure through cracks or joints in the upper impermeable layer.

2.2.2 The hydraulic categories

According to hydraulics, there are two main categories of springs that need to be understood for planning and constructing spring catchments:

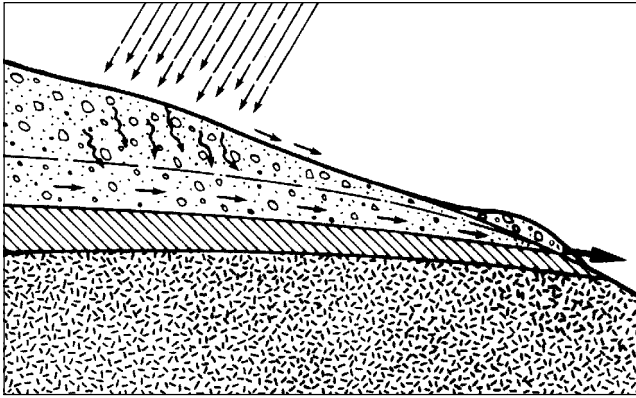

Fig. 8

Gravity springs flow on a natural underground slope to the surface. The water flows more or less horizontally out of the ground.

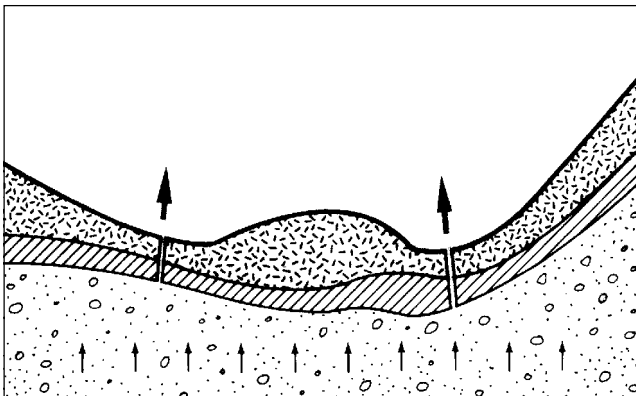

Fig. 9

Artesian springs occur when water is trapped between impervious layers and is forced to the surface under pressure. At these springs the water comes vertically out of the ground.

2.3 Water quality

The factors determining water quality are briefly described below. Water quality is discussed for each of the principal milestones in the water cycle, following the course of water from evaporation and evapotranspiration (from the sea, ground or plants) right to the rising point of the spring (compare Fig. 2).

a) Evaporated water is normally of pure quality but it may become contaminated by airborne pollution (depending on industries, traffic, etc.).

b) The land surface at the intake area (and the activities conducted on it) has a very direct effect on water quality. For example, fertilisers and pesticides used in farming can be washed into surface water courses and then leached into groundwater, resulting in gradually increasing concentrations of contaminants to toxic levels. Open-air defecation and/or pit latrines in the intake area can cause bacteriological or viral contamination.

c) Since the topographical drainage basin does not necessarily correspond with the geological or hydrological drainage of a given area, farming or latrines in areas surrounding the intake could also lead to contamination of a particular spring.

d) The thickness and nature of the stratum covering the water-bearing layer also has an influence. The thicker and less permeable the covering stratum is, the better protected the spring becomes because of more effective natural filtration.

e) The water-bearing layer through which the water flows can influence the water quality. Depending on the mineral composition of both the intake area and water bearing layer, some minerals may be washed out or dissolved in the passing water. The presence of some minerals in a water sample can be acceptable or even beneficial, whilst others can be undesirable because of toxic or taste considerations. For example, moderate levels of dissolved calcium can compensate for excessive acidity but high levels of dissolved iron can lead to an unpleasant taste and colour. In order to ensure that drinking water can have no ill effects on human health, the WHO has produced numerous standards that define safe thresholds for a large number of solutes commonly encountered in groundwater.

f) The type and granulation of the water-bearing layer and the length of the water flow from the intake area to the rising point also have an effect on the water quality. These factors influence the degree to which natural filtration can occur, affecting the level of biological purification that the water undergoes.

g) As the last part in the chain, the catchment design and construction can negatively influence water quality. For example, an inappropriate filterpackage may cause a washing out of sand and silt from the water bearing layer.

Remark: While harmful substances arising from polluted air or chemical contamination of the waterbearing layer can only be removed by treatment, all other

harmful effects can be prevented when the design and construction guidelines provided in chapter 4 are strictly followed. Special attention should be paid to protection of groundwater from pesticide contamination. The growing threat from increased concentration of pathogenic and carcinogenic chemicals in the groundwater is still underestimated or even not recognized.

2.4 Water quantity

The factors determining water quantity are briefly described below. Water quantity is discussed for each of the principal milestones in the water cycle, following the course of water from evaporation and evapo-transpiration (from the sea, ground or plants) right to the rising point of the spring.

a) Water quantity depends directly on annual rainfall patterns and their distribution over a long period of time. Rain originates from the condensation of evaporated water either from surface water, ground or vegetation. That's why macro-climatic conditions change if for instance vegetation or forests are reduced. These macro-climatic changes become more critical for those areas which are at a further distance inland from the sea, and therefore do not directly receive evaporated water from the sea (see Fig. 1, page 2).

b) The nature and gradient of the surface onto which the rain falls has a significant influence on the infiltration rate. (see Fig. 10 to 12)

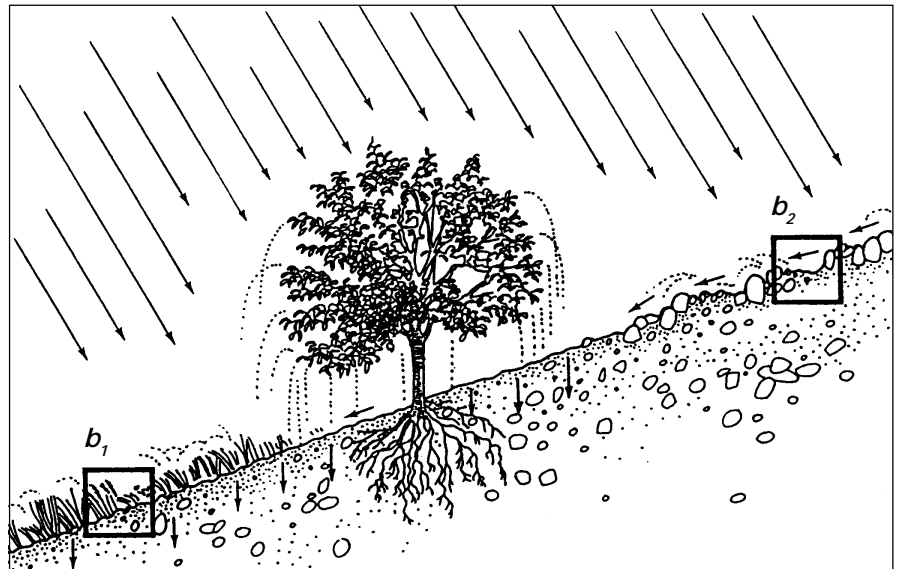

Fig. 10

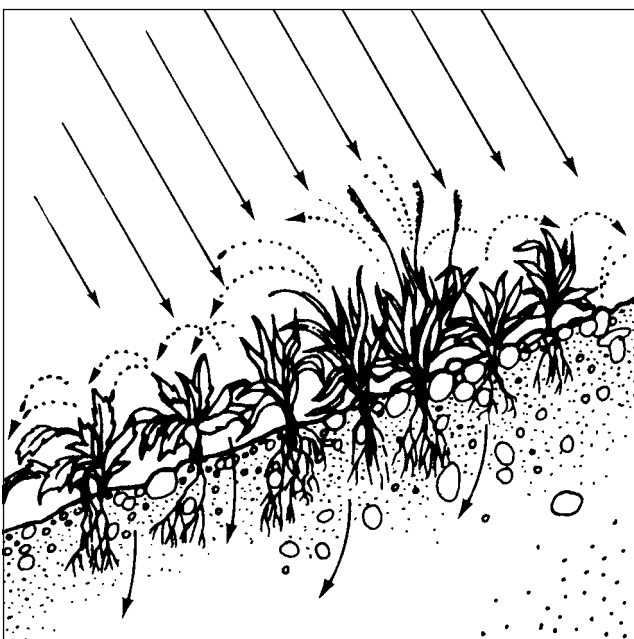

Fig. 11

b₁) A vegetated surface with a gentle gradient will allow for increased infiltration compared to bare land.

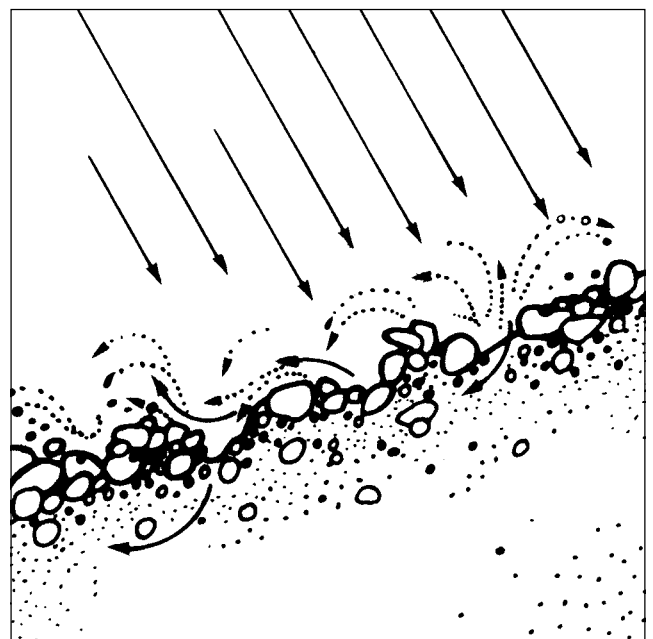

Fig. 12

b₂) Bare land has a reduced capacity to absorb water and causes quick runoff and erosion.

- c) The water bearing layer has a very important property, acting as a buffer which can compensate for the uneven distribution of annual rainfall. A water bearing layer with a large storage capacity and fine granulation is characterised by a low infiltration velocity. This guarantees a continuous flow at the spring with minimal fluctuations after each rainfall.
- d) Consumption of water by various kinds of trees differs considerably. Eucalyptus trees, for example, consume a high amount of water and may cause a source to dry off, while other local species may consume much less. Trees which reach with their roots into the water table may reduce the overall yield of the source, despite their beneficial effect on the surface infiltration rate.

- e) An unsuitable catchment design or an improper method of construction can negatively influence the yield of the spring. Backstowing of spring flow at any time during construction or operation may force the groundwater to find a different outlet. This new outlet may prove impossible to trace. An increase of flow may be observed during initial excavations at a spring, but this increase will return to normal levels once the watertable behind the outlet becomes stabilized again.

Remark: While macro-climatic conditions can only be influenced by national or regional measures (afforestation programs), the infiltration rate in the intake area can be stabilized through the implementation of locally controlled measures such as afforestation, check-dams etc., (see chap. 3).



Storage of precious spring water originating from the mountains



Pressure of land use in the intake area

3.0 General remarks

This chapter describes the preparatory steps to be taken prior to any construction work. It is highly recommended that the technical steps outlined here are incorporated into the community participation program as described in "Management Guide" manual (Volume 1 of this publication series). The tracing of springs may be a difficult job requiring the participation of villagers for a couple of days. While the preliminary investigations at the spring site can be carried out just after a spring has been traced, water testing and continuous observation of the spring flow will be implemented at a later stage.

3.1 Tracing for springs

Tracing for springs requires much practical experience, a sense for careful observation, patience, persistence, common sense and even physical fitness. Often it is necessary to follow along watercourses for some distance, walking and climbing for hours to find reasonably good sources. In some cases a single day may not be sufficient to ensure success. Villagers may be asked to undertake their own observations in a wider area before the technician returns for a second time. At times it may be observed that villagers are reluctant to disclose the existence of a certain spring because of private or cultural reasons. Such attitudes or beliefs need to be respected and incorporated in any construction planning.

The following suggestions may be useful when tracing for springs:

- a) It is always advisable to investigate the source which the villagers are already using for their water requirements.
- b) Villagers and hunters, who know the area, may be the best guides to give information about potential new water sources.
- c) The best places to look for springs are on the slopes of hillsides and river valleys.
- d) It is often necessary to follow along streams and rivulets, walking and climbing for hours to find the rising point of a potentially good source.
- e) Localised green vegetation at specific points in otherwise dry areas may also indicate the presence of a spring.
- f) Sometimes, underground sources may emerge directly into a stream or rivulet. It may be necessary to check for changes in the flow of water along the stream or rivulet to be investigated in order to locate a spring with potential for development.
- g) With the help of a divining rod or pendulum an experienced person may demonstrate sensitivity in tracing invisible underground springs. This method may be of supplementary help in making decisions concerning the outline of a catchment construction with different side branches (see Chapter 6.1). The technique can be learned from an experienced person.

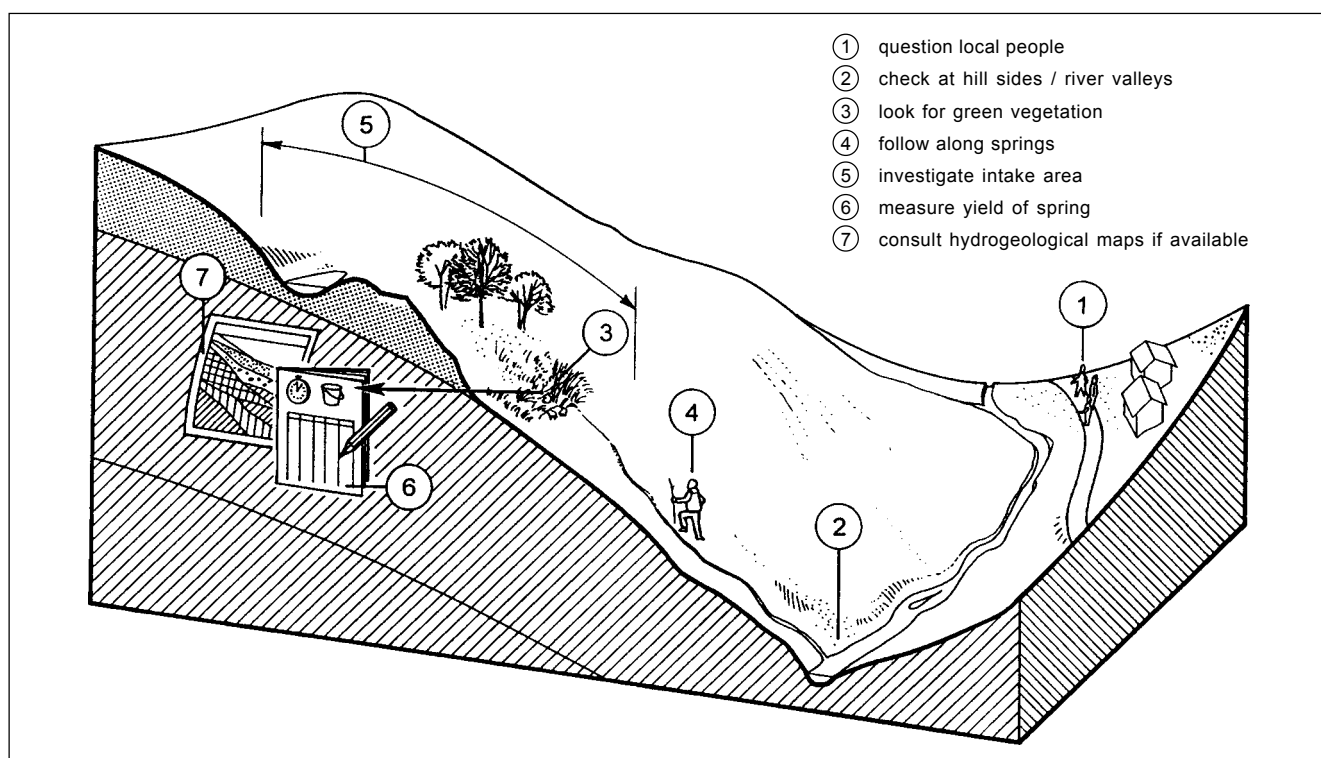

Fig. 13



Discovery of a hidden spring in an overgrown area

3.2 Preliminary observation at the spring site

The observations listed in this section need not necessarily be implemented in the sequence presented. However, it is important that all of the aspects described below are carefully followed up.

3.2.1 Legal Rights

In some societies, springs are regarded as a public facilities. But in other cases, springs may be owned by individuals, particularly in densely populated areas.

In order to avoid any unpleasant surprises after the project is planned, or even worse - constructed, it is important to clarify the ownership of the chosen spring. From the outset, this legal clarification should include the required protection zone as well.

Negotiations about changing the ownership from private to public (with appropriate compensation) are normally left to the villagers concerned. A public agreement must be signed by both parties before detailed planning can be commenced.

3.2.2 Altitude

A spring which is situated above the village represents the most straightforward protection configuration in terms of technical complexity and operation and maintenance cost. This is because water can be supplied by gravity and no pumping is required.

Therefore altitude should already be roughly checked during initial feasibility investigations. The use of a "pocket altimeter", or (where available) of a "box altimeter" may be sufficient. In those cases where the target village can be seen from the spring, a clinometer will fulfill the same purpose. The use of these instruments is described in the engineering manual of this series.

3.2.3 Spring water quality

Many standards have been set for the quality of drinking water, as stated earlier. The World Health Organization (WHO) produces guidelines which govern acceptable drinking water quality. In rural areas however, water is derived from many different sources. For a variety of reasons, the water derived from many of these sources is not treated with disinfectants. It is known however,

that water which is free from bacteriological contamination can be obtained from the ground, provided that the standards of sanitary protection of the source are good enough. That is why whenever drinking water development is planned, the first priority is usually to search for groundwater or if possible spring water, rather than to use water from an unprotected river or stream.

The factors determining the water quality are outlined in chapter 2.3 in the section on "Water quality". The investigations suggested below make up part of a sanitary survey which examines the surrounding environmental hygiene conditions and any potential causes of spring water contamination. A sanitary survey is a form of a risk assessment and not a rigorous examination of actual hygienic conditions. This is a more practical approach, since remedial and sanitary protection measures are revealed by the survey without calling for laboratory analyses (see volume 2 "Engineering" manual). If feasible, however, this sanitary survey may be complemented with bacteriological, chemical and physical water analysis.

The following guidelines indicate how this risk assessment can be conducted, and at the same time they discuss which remedial actions should be taken to safeguard adequate sanitary protection. It is suggested that the process should be conducted in 2 stages; a general overview should be established before a closer analysis can be conducted.

General view:

It is important to go above the rising point of the traced spring to have a general look at the surroundings and to assess the risk of any pollution/contamina-

tion in this area. Attention should be paid to the following aspects (see Fig. 14):

- a) A mental picture must be established about where the water comes from. During this process, it is important to keep in mind that the topographical basin does not necessarily correspond with the underlying geology or hydrological drainage of the area.
- b) It is important to verify that the spring does not originate from a stream, rivulet or pond higher up. In many cases when streams or rivulets get covered by a landslide, part or all of the water will still find a way to flow underneath the new overburden. After many years, the landslide would appear overgrown and could not easily be identified as such, but the water emerging from underneath would appear as a false spring. In other cases, streams or rivulets disappear by seeping into cracks before they emerge again at a lower place, again appearing as a false spring.
- c) It is also important to verify that the intake area is free from farming activity or settlements and that no such projects are planned for the future. This ensures that the spring development will remain free from contamination though fertilizer and pesticide use, latrines, graveyards, road constructions etc.
- d) Deforestation, over-grazing etc. within the intake area may lead to erosion and consequentially high rates of surface run-off. This leads to less infiltration and even turbidity of the groundwater. In this case, remedial measures need to be foreseen such as afforestation, construction of check dams, etc.

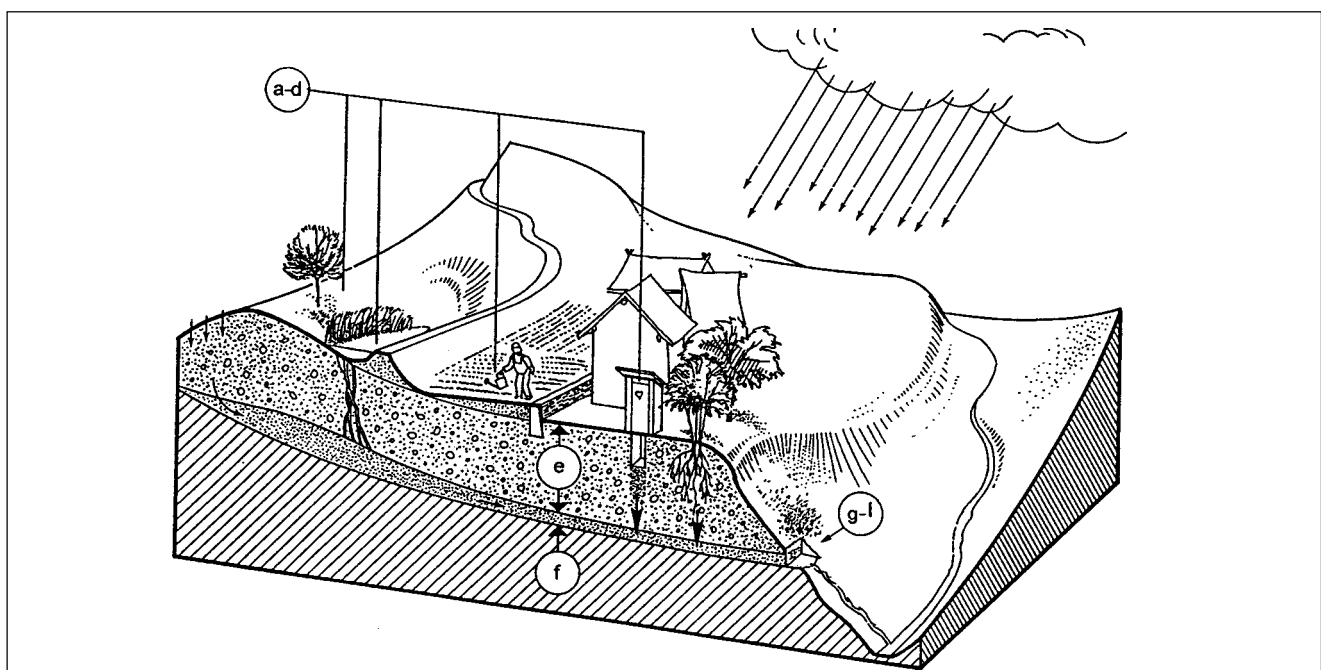

Fig. 14

Closer look:

Taking a closer look at the spring itself and at the surrounding area the following aspects should be investigated:

- e) The thickness and nature of the covering stratum needs to be investigated by using a pickaxe or spade. The thicker and less permeable the covering stratum is, the safer the spring is assumed to be. This is because such covering layers are better at protecting groundwater from contamination which may be present at the surface.
- f) The thickness and nature of the water-bearing layer should also be checked. If the water-bearing layer consists mainly of large stones without finer aggregates in between, this may be a sign of a former streambed (mountain slide spring).
- g) The spring water itself should be investigated at this stage. The parameters included in the "testing without equipment" in chapter 3.3.3 may be considered.
- h) The characteristics of fluctuations in the spring flow between the dry and wet seasons gives direct information about the quality of the spring water. The flow depends on the different factors mentioned above like intake area, covering stratum, and the water bearing layer.

A fluctuation factor (= wet season flow divided by dry season flow) of more than 50 indicates that there is direct infiltration of rainwater from the immediate surroundings:

- very good factor 1 : 1 - 10
- good factor 1 : 10 - 20
- reasonable factor 1 : 20 - 50
- unreliable factor 1 : over 50

- i) A safe spring will not show an increase in flow immediately after heavy rainfall, but only a few weeks later. In cases where rainwater flows quickly through the ground, pathogenic bacteria will be simply carried along with the flow and the purification effect of the water-bearing layer is small. It is a known fact that contamination of groundwater is more likely to occur in the rainy season.
- k) The presence of certain plants as well as specific insects and aquatic animals which prefer clean and fresh water are biological indicators of good water quality.

- l) Reliable springs and groundwater maintain a stable temperature when measured over any 24-hour period and only slight differences are exhibited between seasons. The temperature of such springs is normally slightly below the average air temperature.

3.2.4 Water quantity

The factors determining water quantity are outlined in chapter 2.4. The following section provides some instructions on how these factors can be assessed during a preliminary survey:

Seasonal rainfall variations influence the output of a spring. This fluctuation must be understood when designing a water supply in order to make sure that enough water will be available during the dry period of the year. Graphs of annual rainfall patterns (details of total rainfall and seasonal distribution) covering most geographic regions of the world are increasingly accessible from numerous on-line and text-based resources.

Because of seasonal variations in output flow, springs intended to feed a water supply must be measured monthly for at least a period of one year before the final design is started. Furthermore, if annual rainfall data are available covering a number of years, the year of investigation should be compared with previous years to get an idea about the minimal yield that can be expected. The longer the measuring period, the more reliable the result - and consequently the more reliable the water supply.

There is a time interval between minimum/maximum rainfall and minimum/maximum yield of a spring. This means that the lowest yield should not occur at the end of the dry period but some weeks or even months later. This time interval shows that the spring water originates from a water-bearing layer and is not surface water penetrating from above the catchment area.

The spring yield can be expressed in many different ways. It is important to choose one unit of measurement and to stay with it, as changing or using different units will cause confusion. The most practical units of measurement are:

- liters per second
- liters per minute

The yield of springs can vary from a few litres to thousands of litres per minute.



Small gravity contact spring



Large mountain spring

3.3 Water quality testing

3.3.1 Introduction

In proposing methods for spring water quality testing, it is important to consider how the results will be applied. The key question is the relevance of standards currently in force when these are set against the context of locally prevailing circumstances.

As already discussed in chapter 3.2.3 a kind of risk assessment in the catchment area will probably provide sufficient evidence about the quality and safety of a spring. In practical terms, it is often impossible to reject a local water source that does not meet certain quality standards unless an alternative spring is available within a reasonable distance. That is why it is usually inappropriate to impose a rigid standard, but rather to insist on adequate measures of sanitary pro-

tection which significantly improve the quality of spring water. This is particularly true when the only practical alternative is an unprotected traditional source which does not need to meet a quality standard. It must also be remembered that even if perfectly pure (but untreated) water is drawn from a spring, the water is often exposed to a very high risk of contamination when it enters the vessel which is used to carry it back to the homestead.

Nevertheless water quality testing can be useful in many instances, even if it only to confirm the result of the risk assessment. Quality testing is more important with large urban water supplies, or when toxic or cement-iron corrosive compounds are likely to be present.

A brief summary about water testing follows below. For more detailed information, refer to the "Engineering Manual" of this series.

3.3.2 Basic quality requirements and analysing methods

| Basic quality requirements: | Analysis: |
|--|------------------|
| Free from pathogenic (disease causing) organisms | Bacteriological |
| Containing no compounds that have an adverse effect (acute or long-term) on human health Not causing corrosion or encrustation of the water supply system. Not staining clothes that are washed in it. Not staining food that is cooked in it | Chemical |
| Fairly clear (i.e. low turbidity, little color). Not saline (salty). Can also be analysed chemically. Containing no compounds that cause an offensive taste or smell. | Physical |

3.3.3 Testing without equipment

This method is not infallible, but it provides good indications about the possible degree of contamination in a water sample. The method could also be form part of the risk assessment described in chapter 3.2.3. The

technique should only be applied by a surveyor who already has a good deal of practical experience.

The following table provides guidelines and tips on how different parameters can be tested without equipment.

| Analysis | Testing procedure |
|-----------------|--|
| Bacteriological | The absence of pathogenic (disease causing) organisms is strongly indicated if villagers have used the spring for many years without health problems linked directly to the water quality. If the result of the risk assessment (chapt. 3.2.3) is good, many surveyors may also drink water from the spring and therefore test for contamination on their own bodies. - Note: results from a single sample are insufficient to draw reliable conclusions (i.e. possible contamination after heavy rains). |
| chemical | <p>Taste: Water of good quality should not taste of iron, chloride or salt.</p> <p>Odor: There should be no hint of any odour; any development of gas means that decay is taking place somehow.</p> <p>Color: The presence of iron or manganese can be tested in either of the following ways:</p> <ol style="list-style-type: none"> pour a fresh sample into a glass and observe it over a period of time. If a reddish, yellow or brown deposit or precipitate develops, iron is present. If the deposit is black or grey, manganese is present. place a few drops of the sample onto white paper and allow to dry. If the edge of the water mark is brown, iron is present. If it is black, manganese is present. |
| physical | <p>Turbidity: Use a clear glass bottle and check for cloudiness. Water of good quality doesn't present any turbidity. (Turbidity is caused by soil, sand or organic matter.)</p> <p>Corrosivity: The composition of the water-bearing layer may provide indications. For example if limestone is completely absent, the risk of corrosion is high.</p> |

3.3.4 Testing with equipment

A wide range of test kits is commercially available and it is suggested that certain critical minimal tests should be carried out for new water supplies in areas where only limited information is available. Basic tests should cover nitrate or fluoride content (both can have an adverse effect on human health), pH, free carbon dioxide and hardness (these last three parameters give an indication of how aggressively the water may corrode certain water distribution systems).

For detailed information refer to the "Engineering Manual" in this publication series.

3.4 Measuring the spring flow

Springs intended to feed a water supply must be measured for at least a period of one year to estimate the minimal yield as explored in chapt. 3.2.4.

3.4.1 Simple bucket method

Firstly, the spring flow is channelled into a collection basin that has been dammed at one end. Make sure that the basin collects all of the available flow. Then place a pipe through the top of the dam so that all of

the collected water now flows freely through the pipe. Allow the spring to run for some time after the dam construction has been completed, and measure when the flow becomes steady. If the flow of the spring is such that the measuring bucket gets filled up too quickly (in less than 5 seconds), the flow should be channelled through several pipes, each of which is measured separately. In this case, the total flow is the sum of these separate measurements.

For the flow measurement, place a bucket of a known volume under the pipe to catch the water. For springs with very low flow, a 1 litre bucket will do. For a bigger flow, one might use a ten or twenty litre bucket; alternatively, the flow can be divided into several channels which are then measured separately (see photo on cover page). With a watch, measure the amount of time taken (in seconds) to fill the bucket. Divide the volume of water collected by the time of collection to find the rate of flow in litres per second. Make at least 4 to 5 readings in this way. If the amount of time taken to fill the bucket varies by more than 10% to 20% between measurements, you know that the collecting basin is either being drained or is still filling up. Repeat the measurements until a stable reading is achieved. (see examples on the next page)

3.4.2 Other methods

For information concerning V-notch flow measurement and other methods, refer to the "Engineering Manual" of this series.

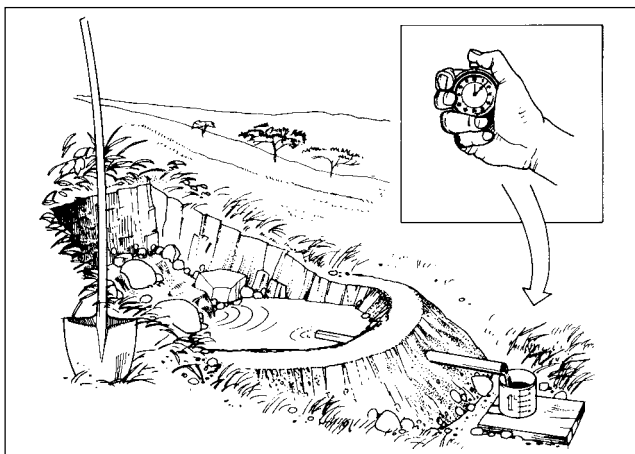

Fig. 15



Examples:

a) If an 8-litre bucket fills up in 20 seconds, the calculation for the daily yield is as follows;

$$\text{Yield in litres/sec} = \frac{8 \text{ litres}}{20 \text{ seconds}} = 0.4 \text{ l/s}$$

1 minute has 60 seconds, 1 hour has 60 minutes and 1 day has 24 hours, therefore the yield per day is:

$$\mathbf{0.4 \text{ litres} \times 60 \text{ seconds} \times 60 \text{ minutes} \times 24 \text{ hours} = 34'560 \text{ litres}}$$

b) A 20-litre bucket fills up in 15 seconds.

$$\text{Yield in litres/sec} = \frac{20 \text{ litre}}{15 \text{ seconds}} = 1.33 \text{ l/s}$$

Yield per day:

$$\mathbf{1.33 \text{ litres} \times 60 \text{ seconds} \times 60 \text{ minutes} \times 24 \text{ hours} = 115'200 \text{ litres}}$$

c) A 1-litre bucket fills up in 25 seconds.

$$\text{Yield in litres/sec} = \frac{1 \text{ litre}}{25 \text{ seconds}} = 0.04 \text{ l/s}$$

Yield per day:

$$\mathbf{0.04 \text{ litres} \times 60 \text{ seconds} \times 60 \text{ minutes} \times 24 \text{ hours} = 3'450 \text{ litres}}$$

3.5 Balancing the spring flow with the water demand

Detailed information about how to calculate the ratio between the available spring water and the water demanded by the consumer can be found in the "Engineering manual" of this series. The data and the two examples contained in this chapter provide a rough rule-of-thumb so that a quick decision can be reached (during the preparatory investigation) as to whether an investigated spring may provide sufficient water to meet the anticipated supply requirements.

Water Demand:

A water supply is normally designed to meet actual needs as well as anticipated demand for 20 to 30 years in the future. Hence, any changes in water use practice as well as the projected population growth over this period need to be considered. Water usage depends on local customs as well as on the supply standard. A typical domestic water use pattern for communal standpipes at a walking distance of less than 200 meters ranges from 25 to 50 litres per person per day. The population growth factor depends on the yearly growth rate and the chosen design period. When considering a yearly growth rate of 2 to 3 percent and a design period 20 to 30 years, the growth factor will be roughly equal to 2 (i.e. a doubling of the population).

| <i>Typical domestic water demand:</i> | | |
|--|--|----------------------------------|
| <i>Type of water supply</i> | <i>Typical water consumption (litres/capita/day)</i> | <i>Range (litres/capita/day)</i> |
| Communal water point (e.g. public well, standpost) – at considerable distance (> 1000 m) – at medium distance (500 - 1000 m) | 7 12 | 5 - 20 10 - 15 |
| Village well walking distance < 250 m | 20 | 15 - 25 |
| Communal standpipe walking distance < 250 m | 30 | 20 - 50 |
| Yard connection (tap placed in house-yard) | 40 | 20 - 80 |
| House connection – single tap – multiple tap | 50 150 | 30 - 60 70 - 250 |

Example 1:

A village with an actual population of 250 persons is to be supplied with communal standpipes. The minimum yield of the spring is measured at 14 litres per minute.

The future population for the design period of 25 years is estimated as:

$$2 \times 250 = 500 \text{ persons.}$$

The minimum yield of the spring calculates as follows:

$$14 \text{ l/min.} \times 60 \text{ min.} \times 24 \text{ hours} = 20'160 \text{ l/day}$$

The minimum water usage which can be offered at the end of the design period amounts to:

$$\frac{20'160 \text{ l/day}}{500 \text{ capita}} = 40 \text{ l/capita/day (lcd)}$$

Conclusion: The available water (40 lcd) should be enough to cover the planned design period, especially when considering that this is based on the minimum flow available from the spring.

Example 2:

A village with an actual population of 325 persons is to be supplied with communal standpipes. On the day of investigation, the yield of the is measured at 30 litres per minute. The peak of the dry season has not been experienced as yet. From other springs already supplying other water schemes in the area, it is known that the yield is expected to decrease by another 50 percent.

The future population for the design period of 25 years is estimated as:

$$2 \times 325 = 650 \text{ persons.}$$

The minimum yield of the spring calculates as follows:

$$50 \% \times 30 \text{ l/min.} = 15 \text{ l/min.}$$

$$15 \text{ l/min.} \times 60 \text{ min.} \times 24 \text{ hours} = 21'600 \text{ l/day}$$

The minimum water usage which can be offered at the end of the design period amounts to:

$$\frac{21'600 \text{ l/day}}{650 \text{ capita}} = 33 \text{ lit/capita/day (lcd)}$$

Conclusion: The available water (33 lcd) is at the lower limits of acceptability for the planned design period. Considering that this that this calculation is based on the estimated minimum yield, the available water is probably sufficient to meet projected demand. However, the spring needs further investigation to get a more precise idea about the true minimum yield!



Gravity contact spring with reasonable cover

4.0 General Remark

After completing the preparatory investigations (chapter 3) the most promising spring has been selected. The following flowchart shows the sequence of the decision process. The criteria to be met at each decision point are discussed in chapter 3. The steps to be taken when the criteria are not fulfilled are described in chapter 4.2.

4.1 Sequences of selection process

| <i>Subject to be analysed</i> | <i>Selection criteria</i> reference chapter | <i>Decision sequences</i> |
|--|--|---|
| distance to supply area (the closer, the better) (a) legal rights to spring (public ownership?) (b) altitude (site above supply area?) (c) water quality (d) water quantity | 3.2.1 3.2.2 3.2.3 (3.3) 3.2.4 (3.4) | <p>starting point</p> <p>NO — continue negotiations, or look for an alternative spring</p> <p>YES</p> <p>NO — look for an alternative spring</p> <p>YES</p> <p>insufficient — take necessary protection measures. if impossible, look for alternative spring</p> <p>OK</p> <p>insufficient — look for complementary springs, reduce water consumption</p> <p>OK</p> <p>start design and construction (chapt. 4)</p> |

4.2 Remedial measures for insufficient spring flow

Normally, springs do not occur in great numbers. That is why springs are valued highly and should not be lightly abandoned, even if they are unable to meet needs completely. Remedial or improvement measures may be possible and should be considered before a potential spring is rejected if favour of the search for an alternative.

In the following section, remedial measures are discussed for each decision points (a) to (d) shown in the flowchart on the previous page.

(a) Legal rights

Negotiations about changing the ownership of a spring from private to public (with appropriate compensation) are normally left to the villagers concerned. The process of negotiating a successful transfer can sometimes take months or even years. In some cases, the legal authority (government) may be involved to take a decision.

(b) Altitude

In cases where a more suitable (higher) alternative spring can be traced at a greater distance, the spring situated below the supply area should be dismissed. However, if no alternative spring is available, the guidelines provided in the "Engineering Manual" of this series are to be considered.

(c) Water quality

As already stated in earlier sections, it is inappropriate to impose a rigid standard, but rather to insist on adequate measures of sanitary protection. Such measures should significantly improve the quality of the protected spring water when compared with unprotected traditional sources that might have otherwise been used. The implementation of some sanitary protection measures may require considerable time, e.g. changes in land utilization patterns at the intake area. Nonetheless, sufficient time and attention should be provided to implement the required sanitary protection (see also chapt. 5.1. "the protection zone").

(d) Water quantity

As already indicated in chapter 3.5, standards for water usage per capita should not be regarded as rigid "yes/no" selection criteria. If need arises, additional springs may be collected at a later stage. In some cases, it may also possible that high quality spring water be exclusively reserved for human consumption only, with bathing and washing being carried out at improved traditional places such as riversides.

- (a) water bearing layer
- (b) coverage of source
- (c) catchment dam
- (d) filter package
- (e) impermeable coat (concrete)
- (f) supply pipe
- (g) overflow pipe

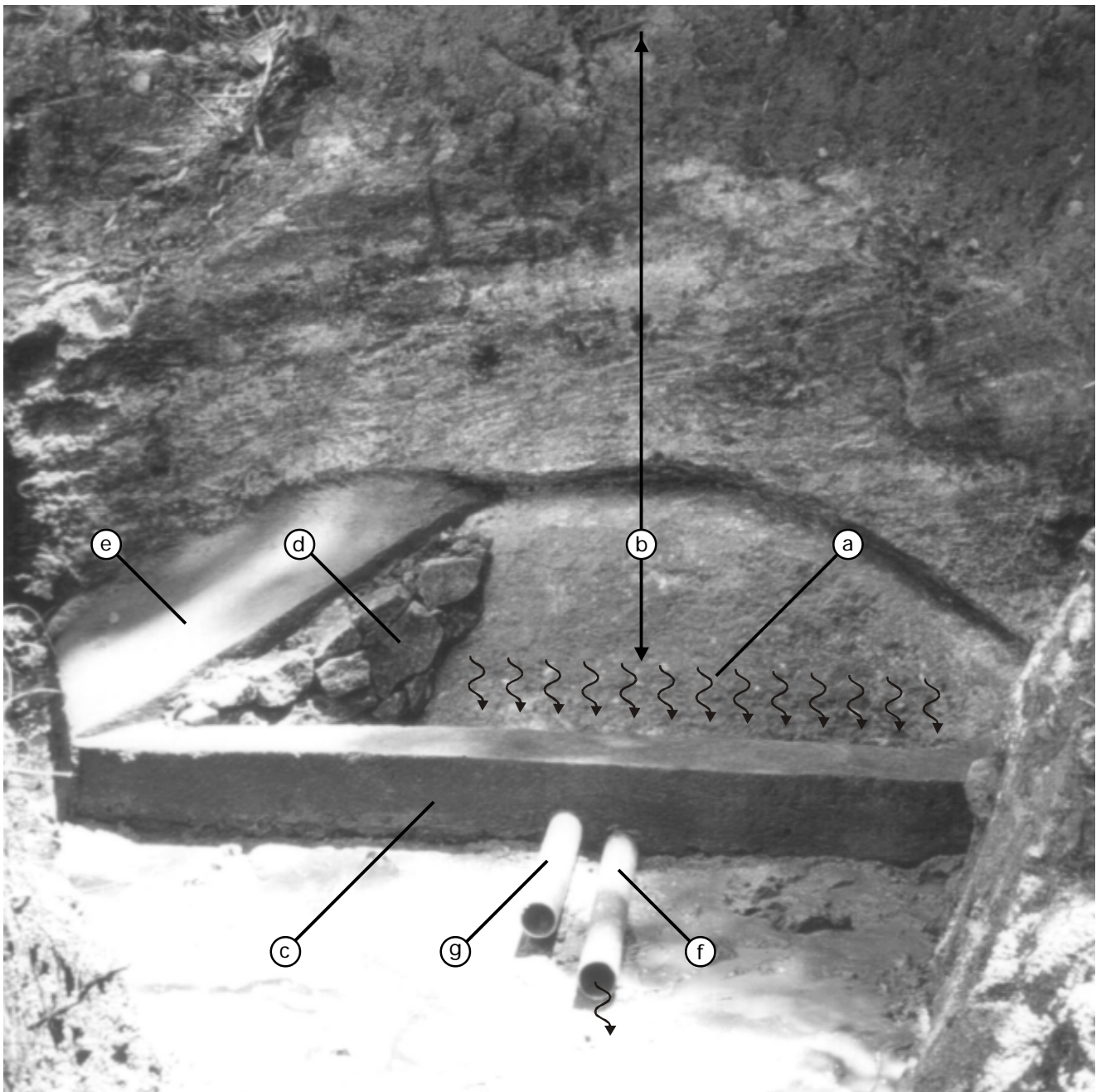

The elements of a typical spring catchment

5.0 General remarks

The design and construction of the catchment with all of its structures must be carried out very carefully. This component forms the heart of the supply and once the construction is completed, the area will not be accessible again. In the event of a catchment failure, the entire water supply system will break down. If the possibility to feed the water scheme from multiple sources exists, this option should be exploited. This is so that if one source fails, others continue to feed the system.

The catchment area can be divided into the five components as shown in Fig. 16 below.

In the following sections, information is provided covering the protection zone, the design and construction of the catchment, the supply pipe and the spring chambers. The two main classes of springs, gravity and artesian springs, are discussed separately. Since gravity springs are the most commonly encountered class, their catchment design and construction are described in detail, while for artesian spring catchments only the parts which differ from gravity spring catchments are discussed.

5.1 The protection zone

The catchment or intake area includes the area from which the spring is supplied (by infiltration and percola-

tion of rainwater) to the spot where the water comes to the surface. The part closer around the spring is called the inner protection zone. Because the spring water is protected by the ground lying above the water-bearing layer, the size of the required protection zone for each catchment depends on the depth and the nature of the covering stratum.

The radius of the extended protection zone has to be larger when the spring catchment is nearer to the surface and when the covering stratum is more permeable. The radius of the extended protection zone has to be at least 100 metres, but may require up to 150 metres and in special cases even more. To have good control over the protected zone and to maintain the required infiltration rate, it is advisable to introduce vegetation and eventually build some runoff barriers (check dams) in this zone.

The following points have to be considered at the protection zone:

- a) It is very important that the ownership of the spring and the protection zone is clearly settled. This means that the spring, together with the protection zone, must be in the possession of the project owner. This would normally be the community concerned.
- b) The inner area (with a radius of 10 m to 20 m around the catchment) should only be planted with grass - all trees and bushes should be uprooted.

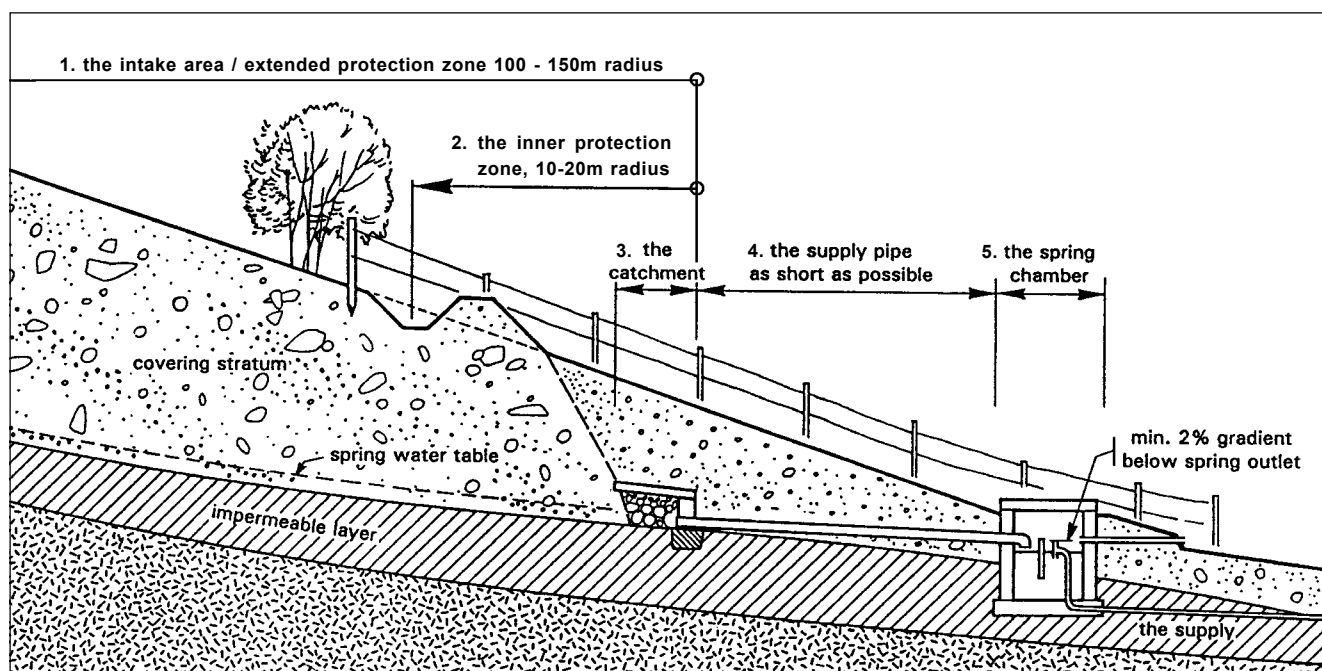

Fig. 16

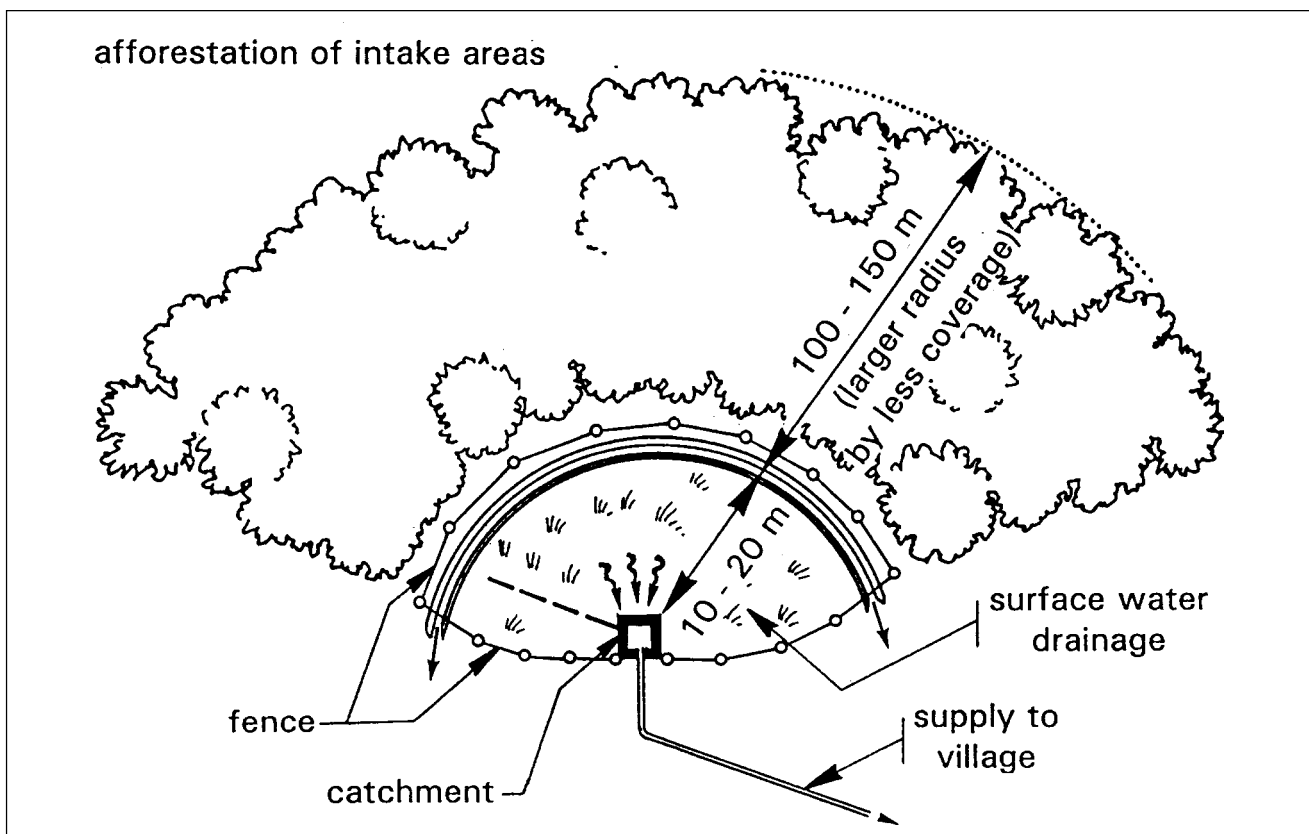

Fig. 17

This is because roots can damage the catchment by cracking the structures or by blocking the pipes. In any case, the inner area needs to be fenced with barbed wire to prevent any direct contamination.

strong bushes around the fence. This hedge protects the area from farming or domestic animal grazing and it prevents the establishment of rubbish pits, houses, stables or pit latrines.

- c) Surface water must be diverted out of the inner catchment area by trenches and runoff barriers (stone walls)
- d) The extended protection zone (outside the radius of 20 meters) should be planted with mixed trees and/or bushes to prevent erosion in this area. The planting of trees that absorb large amounts of water (such as eucalyptus) is not recommended for the protection zone. Examples of more useful trees include cypress and pine. However, local varieties which do not absorb large quantities of water should be given priority.
- e) In steep areas, runoff barriers (in the form of stone walls to create small terraces), may be constructed to prevent erosion above the catchment and to maintain conditions for good infiltration.
- f) It is advisable to fence the inner protection zone with barbed wire at least and possibly even to reinforce this measure by planting a solid hedge of

5.2 Gravity spring catchments

5.2.0 General remarks

It is important that the construction at the catchment is carried out very carefully and under the close supervision of an experienced technician. As the heart of the supply, the catchment demands the highest and most experienced craftsmanship available.

Since work at the catchment is normally the first visible activity of a project, villagers are usually very willing to assist with the labour. This involvement is very important to ensure that villagers identify with the project in the long term, but it needs very firm guidance from an experienced foreman or technician who should maintain a constant vigil during construction.

5.2.1 The different phases of construction

The construction of the spring catchment can be divided into the following phases:

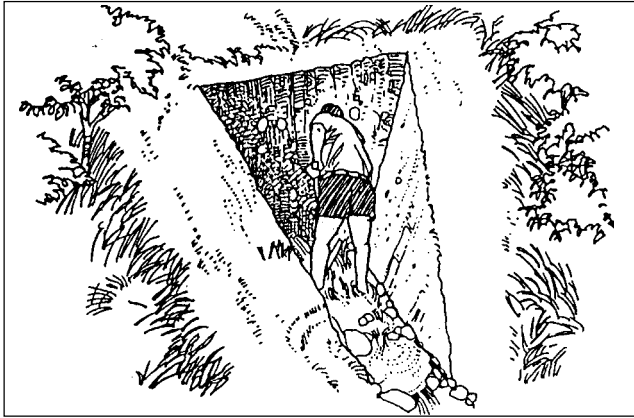

1. Excavation of the spring

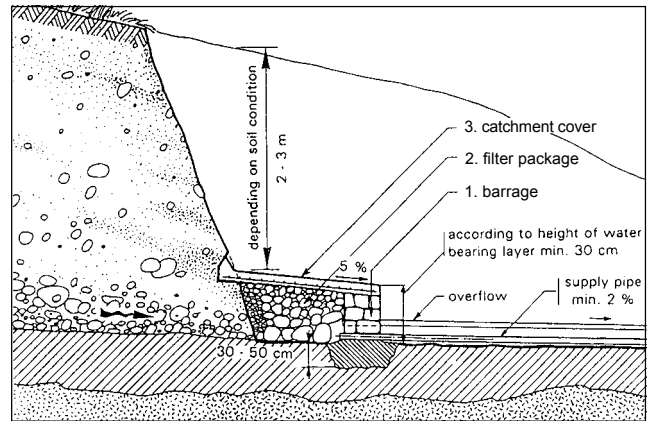

4. Installation of the supply pipe

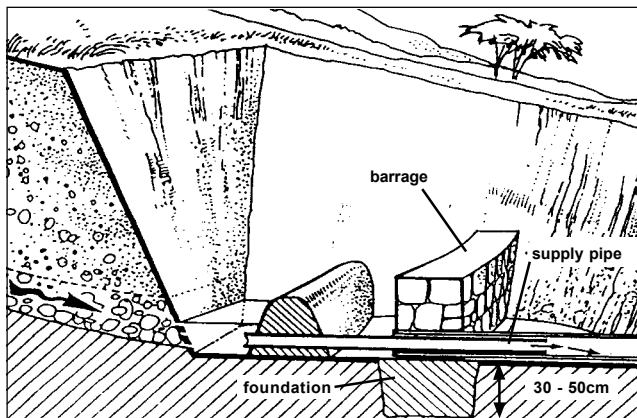

2. Building the catchment

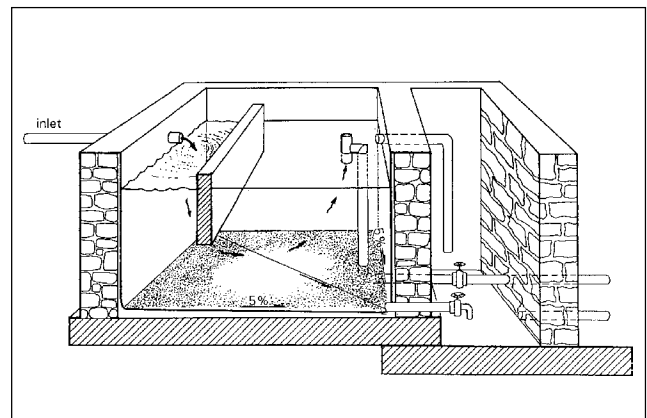

5. Building the spring chamber

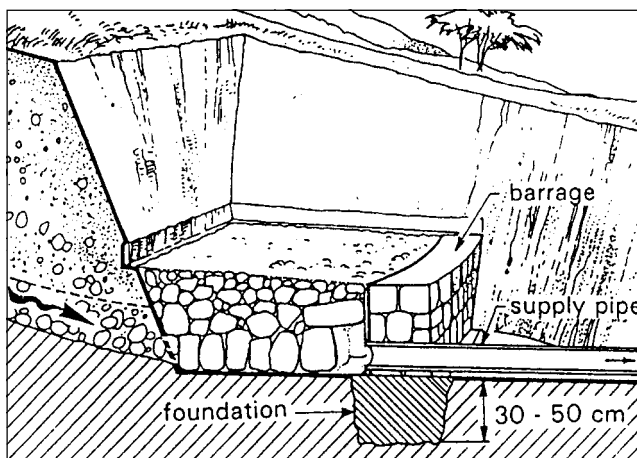

3. Back filling of filter package

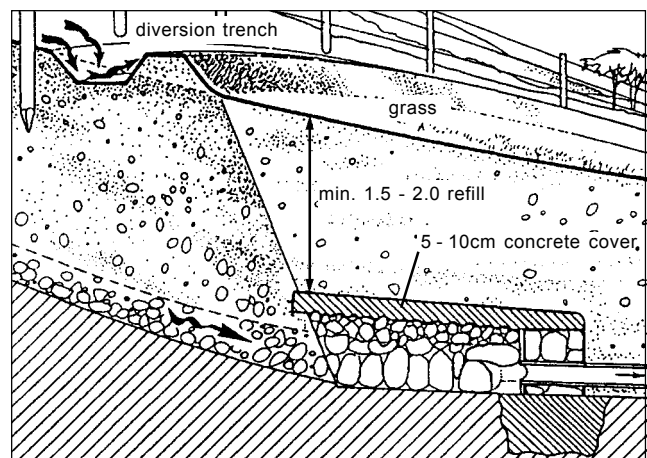

6. Refilling of the earth cover and finishing the protection zone

5.2.2 Excavation

Springs are like people; no two springs are exactly alike. Excavation is necessary to establish how the spring presents itself at the catchment point. This means that the excavation work needs to be adjusted at all times in response to changes in the direction of the flow.

Excavation and construction should be carried out during the peak of the dry season in order to obtain the most reliable springs. Nevertheless, the catchment has to be designed in such a way that it can cope with the peak flow after the rainy season.

The different phases of excavation



Fig. 24

1) Having located the spring source, the surroundings must be cleaned to give a good working place and to get a clear sight of the spring.

2a) Normally, digging at the source is started at the point where water comes out of the ground. Excavation is conducted in form of a furrow, following the flow of the spring just above the impermeable layer.



Fig. 25

2b) In cases where the spring flow rises up out of the ground, the trench has to be dug downwards to reveal the waterbearing layer out of which the spring water originates and flows freely. In cases where excavations cannot be dug deep enough to reach the impervious layer, the construction has to be carried out following the technique for an artesian spring (see chapter 5.3.1).

3) With the water freely flowing from the water bearing layer, excavation is continued following the flow of the source back into the ground. At all times, drainage is required to avoid any increase in pressure on the source underground; any back pressure could force the water to find another exit which may not be accessible anymore. Good drainage also helps the technician to see the direction of the source's flow very clearly, which eases his decision on how to proceed with the excavation.

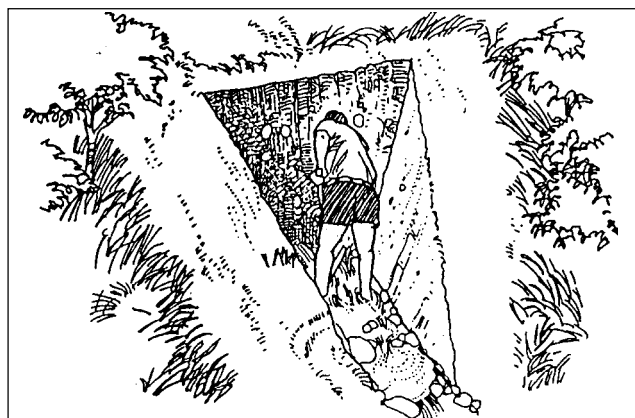

Fig. 26

4) Excavation should be continued up to the point where the earth cover over the source is thick enough to provide the required protection for the catchment. For a rather impermeable loamy earth, a thickness of 2.0 meters may be enough. For loose, stony earth a depth of 3.0 meters and above may be required to prevent contamination. When the earth cover remains shallow, special measures have to be taken at the catchment as well as at the protection zone (see chapter 4.2.6).

Points which require particular attention during excavation can be summarized as follows:

a) In general, the excavation work should be carried out using hand tools (e.g. pick axes and shovels) in order to follow the course of the spring gently.

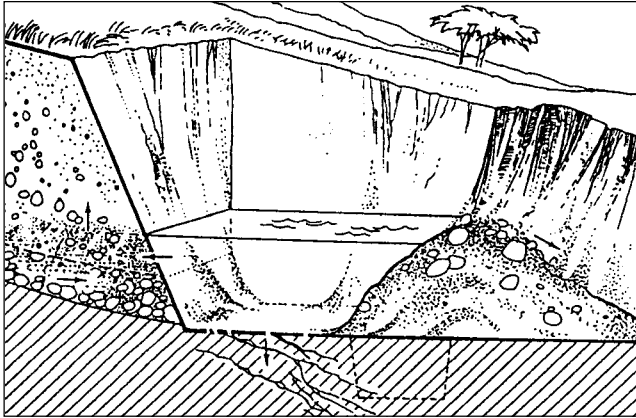
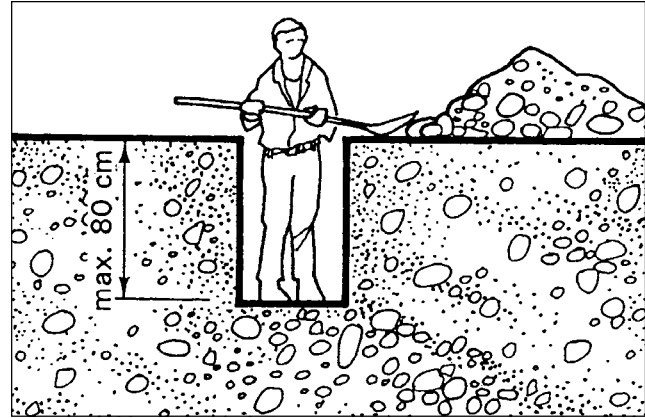

Fig. 27



with solid ground

Fig. 28

- b) At all times during the excavation period the free flow must be guaranteed. If the spring is stowed back there is a very high possibility that it will disappear and find a new way out, but perhaps a hundred meters lower down.
- c) No attempt should be made to change the spring's natural flow rate. If there is any obstruction, the spring can disappear and discharge somewhere else.
- d) Care must be taken not to dig too far into the impervious layer. This may allow the water to seep downwards, causing the spring to disappear.
- e) No blasting should be conducted near the catchment - blasting may cause invisible underground changes (such as cracks) through which the spring could disappear.
- f) The distance between the catchment and any trees or plants with deep roots should be large enough to ensure that no roots can enter the catchment. Trees within a radius of 15 to 20 meters from the catchment must be uprooted.

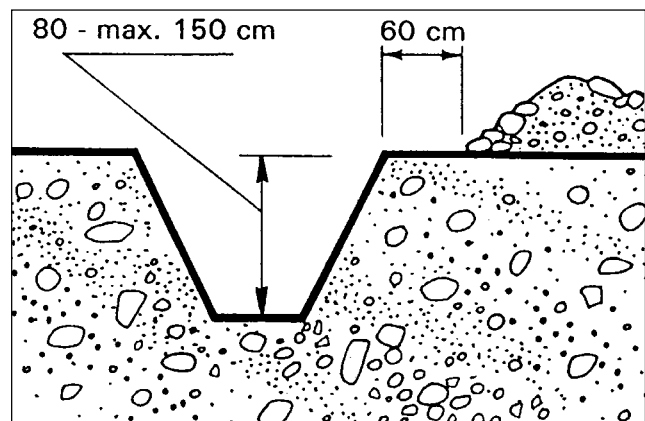

solid ground

Fig. 29

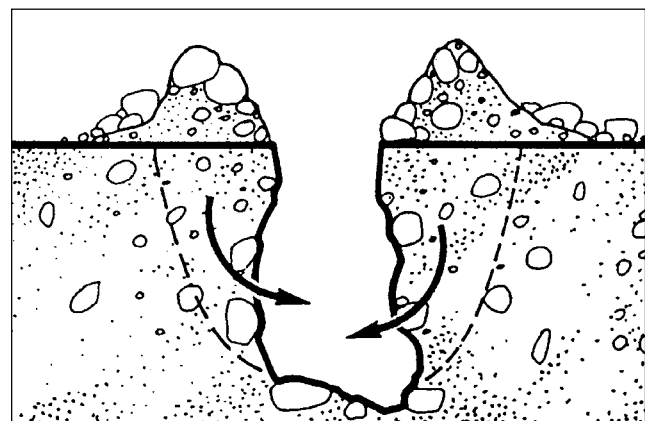

loose ground wrong excavation

Fig. 30

Precautions during excavation

With any excavation work, it is very important to ensure the stability of the side walls.

When the side walls of the trench are higher than 1.5 m, it can be very dangerous for labourers to work inside. The walls can easily collapse and injure people in the trench or backstow the spring. It is therefore important to slope the trench walls to ensure their stability. The slope of the trench walls varies according to the type of ground at the excavation site:

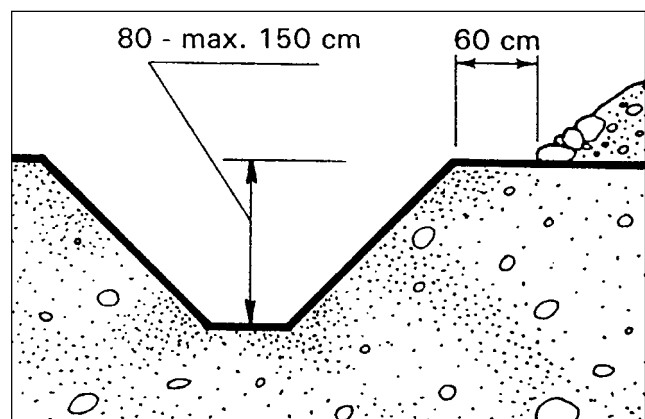

loose ground correct excavation

Fig. 31

In cases where a sloping trench wall cannot be built, stability can be achieved using appropriate shuttering. However, the horizontal supports needed with shuttering will normally obstruct easy excavation. Effective shuttering requires specific training and experience. For more information about shuttering, refer to the "Building Construction" manual of this series.

Excavation of contact spring

A situation that is commonly encountered with gravity springs is that the source water flows from a broad layer (contact spring) and not from a single spot (fracture or tubular spring). This is why water may enter from the side of the trench when excavating back along the spring into the hill side. In general there are two solutions to overcome this problem, as shown in Figs. 33 and 34. The technician must decide which is the most appropriate course of action to take.

2. A side trench at the spot where the secondary water occurs. The digging of the side trench starts only after the main trench is completed.

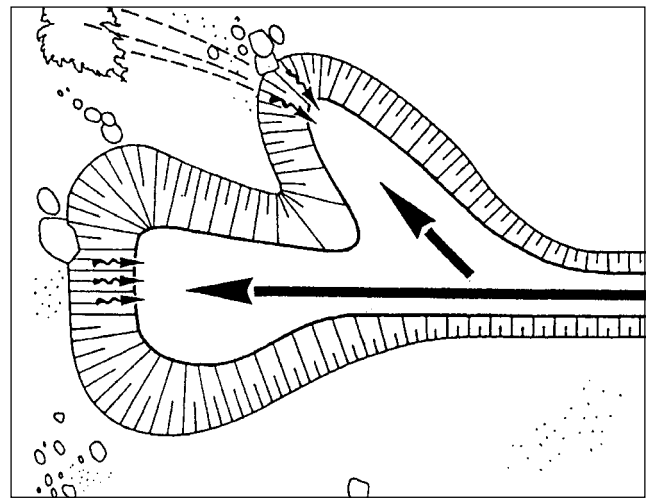

Fig. 34

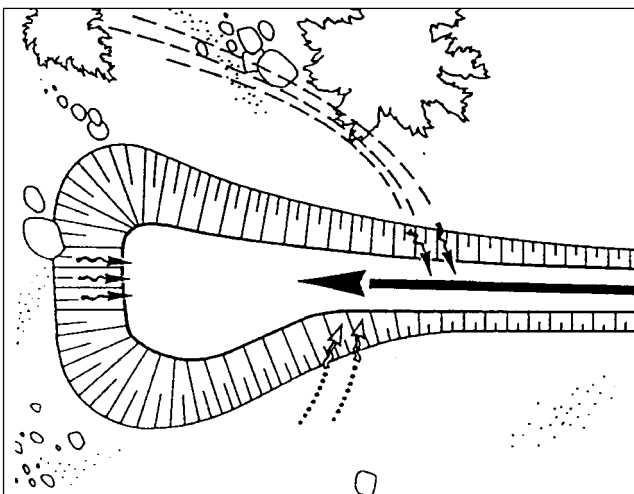

Fig. 32

1. A V- or T-trench at the front of the excavation.

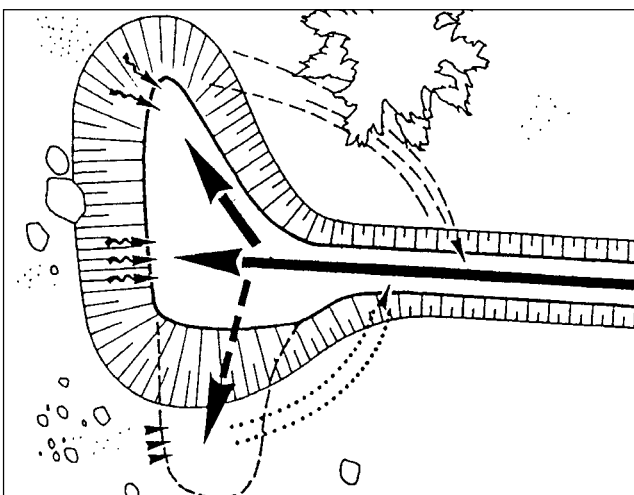

Fig. 33



Contact spring with side trench (see Fig. 34)

5.2.3 Design and Construction

After completing the excavation, the nature of the spring becomes visible and the design of the catchment can be made accordingly. The catchment consists of the following three components with their respective functions (see Figs. 35 and 36):

1. The **barrage**, which directs the source water into the supply system.
2. The **permeable construction** behind the barrage (either in the form of a filter package or as a perforated pipe), which supports the water-bearing layer and prevents it from becoming washed out.
3. The **catchment cover**, which prevents the infiltration of any surface water into the catchment.

5.2.4 The barrage

The barrage (dam) is constructed perpendicular to and in front of the water flowing into the catchment. The barrage directs the source water into the supply pipe, which then conveys the water to the spring chamber.

Before the barrage can be constructed, a temporary dam has to be built in order to divert the flow of the spring away from the place of construction. This is normally achieved with a dam made of clay and the use of a temporary pipe (which is later inserted into the permanent supply pipe).

The barrage has to be built 30-50 cm down into the impermeable layer as well as into both side walls to prevent the water from escaping.

The foundation of the barrage is cast in concrete directly against the ground in order to obtain a tight connection with the impermeable layer. The barrage is then constructed on top of the foundation, either in concrete or stonemasonry. On the inside wall, a plaster must

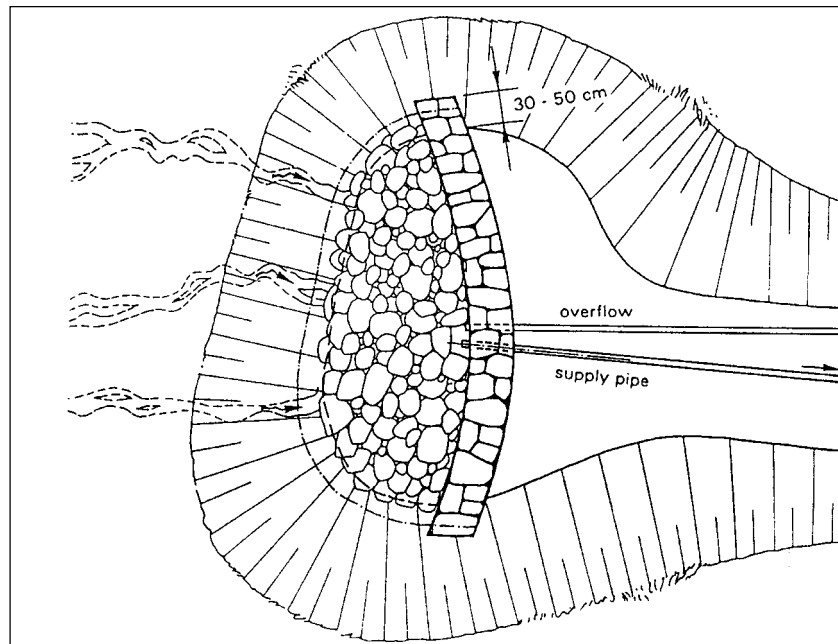

Fig. 35

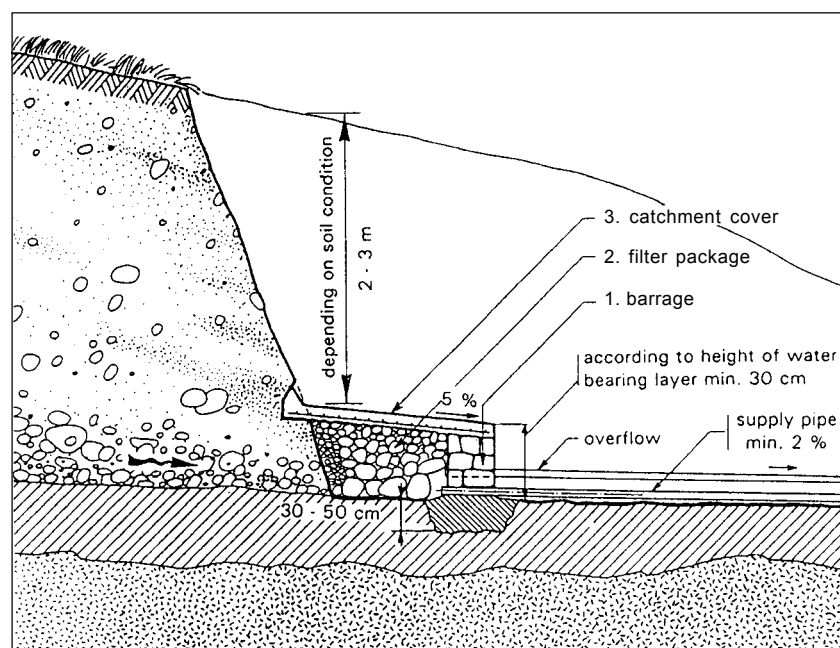

Fig. 36

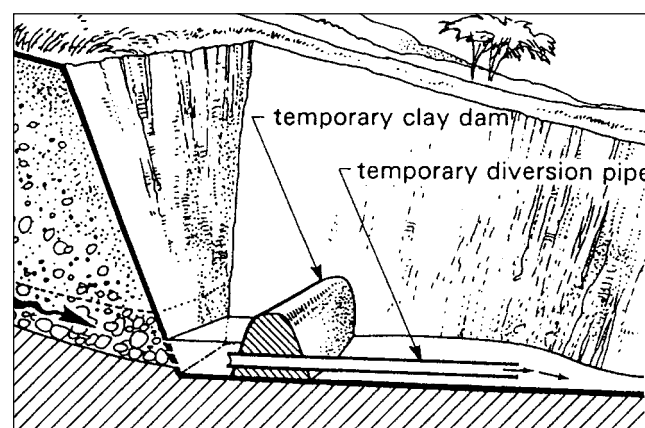

Fig. 37

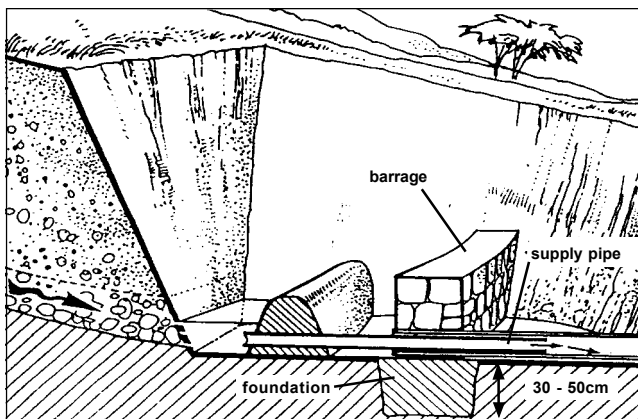

Fig. 38

be applied to make the barrage watertight. The height of the dam should remain low, i.e. not above the height of the top of the water bearing layer.

The supply pipe is placed at the lowest possible point into the barrage, with a constant minimum slope of 3% leading into the spring chamber. The outlet should lie just above the level of the impermeable layer. The pipe material depends on the aggressivity of the water (see chapter 5.4.1).

The minimum diameter is 50 mm (2"). In section 5.4.1, a table shows the required pipe diameter in relation to the maximum spring yield.

It is advisable to install an overflow pipe 5 to 10 cm above the supply pipe. This measure protects the spring catchment in the event of unexpected high flow during the rainy seasons or a blockage of supply pipe.

5.2.5 The permeable construction

The permeable construction consists of a filter package using dry stone masonry and gravel, or a perforated



pipe with a gravel filter package. The purpose of the filter package is to support the water bearing layer so that it does not become washed out, leading to the collapse of the back wall of the catchment.

The cross-section of this catchment filter package should ensure that the maximum yield of the spring can be drained off without obstructing the natural spring flow. In cases where solid ground is encountered, flooring is not normally required. However with sandy ground, a dry pavement has to be provided. In any case, the velocity of water should be limited so that turbulence is kept to a minimum and the bottom of the catchment is not washed out. To limit turbulence, the ground should have a maximum slope of 1-2%, because the drag force on the bottom increases with increasing water velocity. As mentioned in earlier sections, the maximum flow in the rainy season needs to be considered when determining the size and design of the catchment.

5.2.5.1 Dry stone filter package

The option "dry stone filter package" is a simple, inexpensive construction technique that requires only local materials. In the example presented, a filter package is built behind a barrage of dry stone masonry with well brushed and washed stones of 20 to 30 cm diameter. The diameter of the stones is progressively reduced to the size of gravel, filling towards the waterbearing layer as well as to the top of the catchment wall. In this way a filterpackage is achieved which will support the loose earth of the waterbearing layer.

The following points are important to consider:

- a) The top surface of the backfilling must slope at least 5% from the back of the excavation towards the barrage and must make a smooth formwork for the concrete cover.

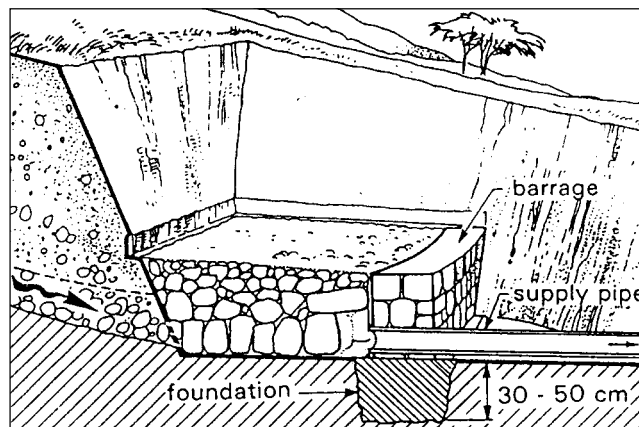

Fig. 39

- b) The backfilling should not be walked on at any time in order to prevent contamination.

5.2.5.2 Perforated pipe

The option "perforated pipe combined with a gravel filter package" is normally built at sources with a lot of fine sediment in the water and/or where the water must be collected via a drainage system.

The perforated pipe should have a maximum slope of 1-2% (an even or gently steepening gradient towards the outlet is desired). The filter package must be built up around the perforated pipe with washed gravel. The diameter of the gravel must be larger than the holes in the perforated pipe, to prevent the gravel from entering the pipe. Finally, the backfilling goes up to the height of the barrage, and can be used as the formwork for the concrete cover.

5.2.6 The cover of the catchment

The cover of the catchment prevents any surface water which may seep through the topsoil from entering into the catchment. Such undesired infiltration could contaminate the spring water. The cover is therefore an essential element of the catchment, and must be constructed with care.

The cover of the catchment is made from a layer of concrete with a minimum thickness of 5 cm, or from a layer of sticky, waterproof clay (20 cm thick) if concrete is not available. The cover is placed on top of the barrage and all around the catchment sides at a penetration of 20cm into the standing soil. A minimum slope of 5% needs to be provided (sloping down over the barrage) to ensure proper drainage of infiltrated surface or rain water.

For concrete covers (this is the normal case), a rather dry concrete mix is poured onto the top layer of gravel of the backfilling. The concrete needs to be well compacted and its surface should be smooth. A coating of mortar applied with a float may be necessary to achieve a smooth finish. It is a good idea to reinforce the waterproof qualities of the concrete cover with a layer of clay on top.

5.2.7 Refilling the earth cover

After the catchment is completed, the excavation must be refilled. Refilling with the original earth should be carried out in layers of 20 cm to 30 cm; each layer

should be packed down before the next layer is added. If the refilled earth is not well packed, it will eventually cause a depression on the surface where rainwater can collect, causing erosion or infiltration at the catchment.

The surface of the refilled area should be planted with grass and protected against erosion with dry stone walls if necessary. At about 10 to 20 m distance uphill from the catchment, a trench to divert surface water should be made.

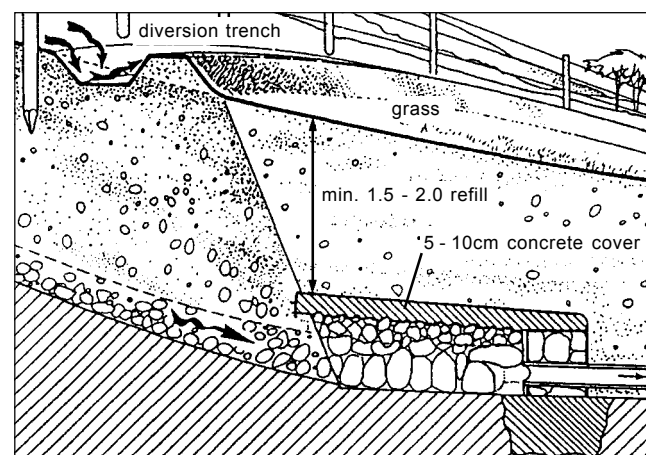

Fig. 40

5.3 Artesian spring catchment

5.3.0 General remarks

A characteristic of artesian springs is that springwater comes vertically out of the ground. This springwater originates from an intake area above the spring, where it seeps into a water bearing layer that later drops below an overlying impermeable layer. In areas where pressure is high, the springwater is forced through cracks in the overlying impermeable layer and on to the surface (see Fig. 1). Artesian springs are less common than gravity springs. The catchment designs and construction of artesian springs on solid ground (such as fissured rock) and on soft, loose soil are different; both types of catchment are described on the following pages.

5.3.1 Artesian spring from solid ground

This type of artesian spring occurs when water emerges through cracks in solid ground. The excavation and construction techniques are very similar to those employed when developing a gravity spring. Therefore

in the following sections, only those aspects which differ from gravity spring development are described.

5.3.1.1 Excavation

As a first step, a downhill trench which starts from the rising point is dug, following the trace of the planned supply pipe. Normally, the trench would be dug down into the solid ground as deeply as possible, with a minimum downhill gradient of 2 to 3%. In this way, the water table at the rising point will be lowered. Excavation is then carried out surrounding the rising point. All the topsoil, stones and removable ground are cleaned away, in such a way that the rising point becomes clearly visible and the water can come up freely.

After a clear picture about the rising point(s) has been obtained, the shape and size of the catchment construction can be established. Further excavation is then carried out to provide sufficient workspace.

Remark: Because the water rises vertically out of the ground with an artesian well, it is not so easily contaminated by surface water (as is the case with the horizontal outflow of a gravity spring). The depth of excavations for artesian catchments have a correspondingly diminished influence over water quality when compared with gravity springs.

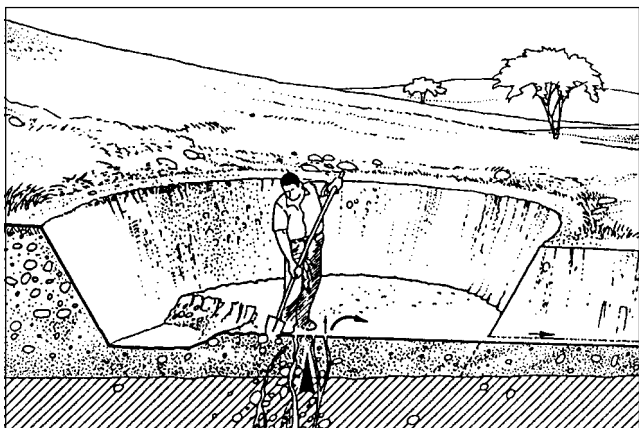

Fig. 41

During excavation, it is important to pay attention to the following points:

- a) All the excavation work has to be done by hand, using pick axes and shovels. Using a crowbar, exploration of the ground below bar helps to decide whether the excavation should go any deeper.
- b) No blasting should occur near the catchment because it may cause invisible underground changes like cracks, through which the spring could disappear.

- c) When excavating, take care to make sure that the holes through which the water emerges do not become blocked.
- d) Always deposit soil outside the excavation area.
- e) Make sure that the water can flow freely out of the catchment area at all times.
- f) The water must never rise up higher than the ground level where excavation started. This situation leads to high pressure at the source and the spring may disappear.
- g) If digging goes deep into the ground, care must be taken that the side walls do not collapse. The side walls are constructed in the same way that gravity type catchment walls are built (see chapter 5.2.2 "Excavation").

5.3.1.2 Design and construction of the catchment

After completing the excavation, the nature of the spring becomes visible so that the design of the catchment can be made accordingly. In general, the water doesn't flow up through a single hole, but is distributed over many different spots. The technician must if the configuration of the spring requires the construction of one large catchment or several smaller catchments. The artesian spring catchment consists of the following three components with their respective functions:

1. The **barrage** as a watertight circle (or rectangle), to collect and direct the water into the supply system.
2. The **permeable construction** (where necessary), to prevent the water-bearing layer from becoming washed out.
3. The **catchment cover**, to prevent the infiltration of surface water into the catchment.

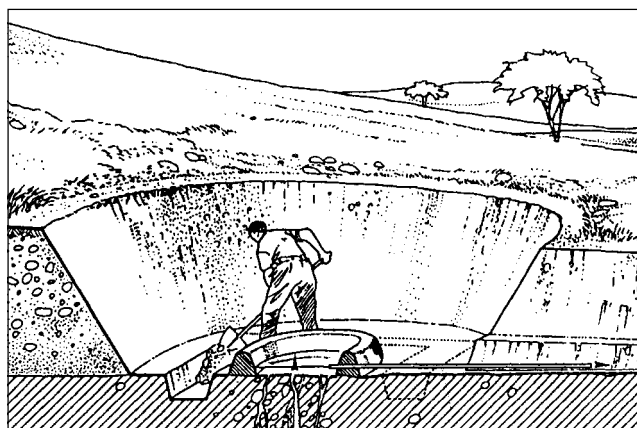

Fig. 42

5.3.1.3 The barrage

Because with artesian springs the water flows vertically out of the ground, the barrage is not a dam. Rather, it is a watertight circular or rectangular construction forming a basin, with spring water entering from the base. It collects the springwater and directs it into the supply pipe, which conveys the water to the spring chamber.

The walls of the structures are 30-50 cm higher than the entry point of the springwater. At the lowest possible point, the supply pipe is set into the wall and led to the spring chamber (with a minimum slope of 3%). Where the springwater flows out of fissured rock, the outlet should be just above where the water enters the catchment.

Before the barrage can be built, the emerging springwater needs to be diverted temporarily. If the output flow is small, a temporary barrage is created with a circumferential clay dam. When the output flow is greater, a prefabricated concrete ring (slightly smaller than the permanent barrage) is required. Water is diverted through a temporary pipe, which is later inserted into the permanent supply pipe.

The barrage foundation should be at least 20 cm thick. The concrete foundation is cast directly into the excavation in order to obtain a tight connection to the impermeable layer. The barrage is then constructed on top of the foundation, either in stone masonry or concrete. On the inside wall, a plaster should be applied to make the barrage watertight.

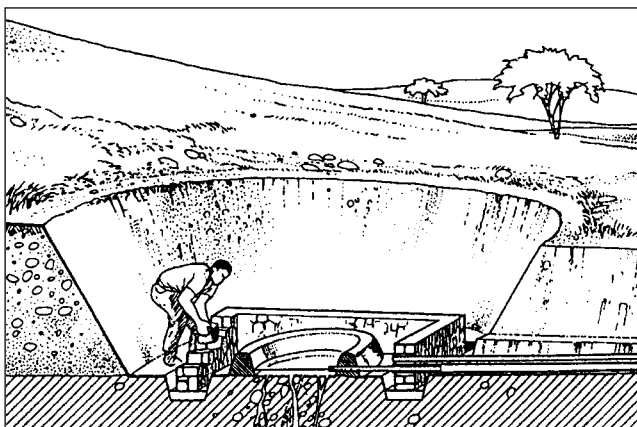

Fig. 43

5.3.1.4 The permeable construction

The purpose of the permeable construction is to support the water bearing layer so that it is not washed out. This measure ensures that the ground underneath the spring cannot collapse.

- a) Normally, artesian spring catchments on solid ground do not require any backfilling with a filter package.
- b) In cases where the water becomes highly turbid during periods of increased flow (rainy season), a filter package should be planned to stop the washing out of the water bearing layer. The composition of the filter package depends on the size of grains being washed out. Gravel of smaller diameter should be packed against the water bearing layer, supported by bigger stones that are carefully placed by hand.

Points for particular attention are as follows:

- to avoid contamination, back filling should not be walked on at any time.
- to avoid blockage of the artesian spring, never allow the catchment to fill up completely.

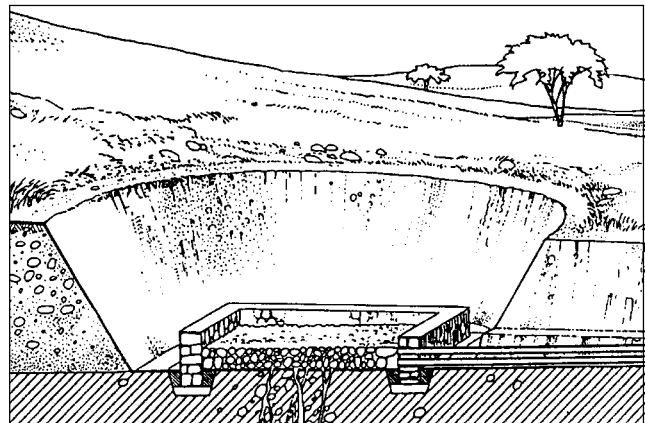

Fig. 44

5.3.1.5 The covering of the catchment

The cover of the catchment prevents direct contamination by infiltration of surface water.

Normally, no entrance is required. However, in cases where blockages are to be expected, a manhole should be foreseen. This manhole can be constructed in the same way that manholes for gravity catchments are built (see chapter 6.4.4).

Since it would not be possible to remove shuttering once the cover slab is cast, precast concrete slabs should be used to cover the catchment. It is important to keep this way constraint in mind during the planning/construction phase. For catchments with a diameter of several meters, either the project must be divided into smaller catchments or pillars must be built to support the precast slabs.

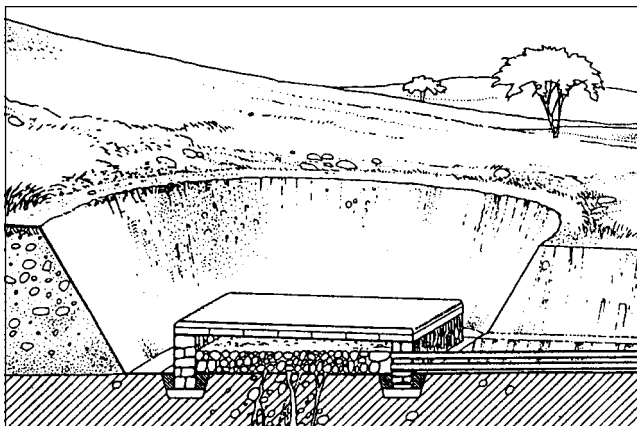

Fig. 45

The length of the slabs should be no more than 2.0 m and their width should be between 0.5 and 1.0 m. The reason for this limit is to maintain the strength of the slab but also to keep its weight to within reasonable limits; it is important to remember that the cast slab must usually be lifted into place manually. After the precast concrete slabs are placed onto the barrage, a wire mesh and a second layer of concrete with a thickness of about 10 cm goes on top. The concrete cover needs to be floated, or a layer of clay is put on top to create a smooth surface. If the covering is done properly, infiltration water will not enter the catchment.

5.3.1.6 Refilling the earth cover

Because water from an artesian spring flows vertically out of the ground at the surface, the excavation is generally not as deep as with gravity spring catchments. Therefore the cover of the artesian spring catchment may lie relatively close to the surface, thus requiring a careful refilling with well-packed earth. The refilling procedure is the same as with the gravity spring catchment (section 5.2.7 "Refilling the earth cover").

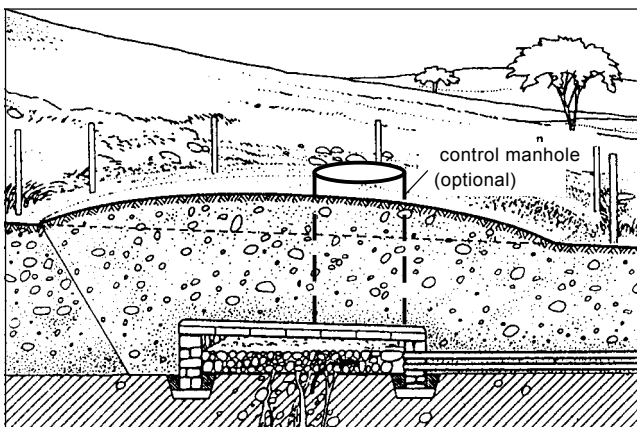

Fig. 46

An overfill directly above the catchment helps to prevent surface water seeping into the catchment area.

5.3.2 Artesian spring from loose ground

This type of artesian spring requires a design and construction procedure similar to that used during the construction of a hand-dug shallow well (refer to "Hand-dug Shallow Wells" in the current series of manuals - Volume 5). The principal difference is that with an artesian spring, the protected water flows continuously out of the catchment structure under gravity.

5.3.2.1 Design and construction

In general, the water doesn't emerge from a single point. Rather, it is distributed over many different holes which may change their position as ground is removed. The technician must decide on the most appropriate size and shape (circular or rectangular) of the catchment.

The building phases for the artesian spring catchment from loose ground differ from the other types in that part of the excavation work is conducted in tandem with part of the barrage (lining) construction.

- a) As a first step, a downhill trench which starts from the rising point is dug, following the trace of the planned supply pipe. The depth and gradient of the excavation depends on the topography of the area. Normally the trench would be dug as deeply as possible and with a minimum gradient of between 2% and 3%. In this way, the water table at the rising point will be lowered.

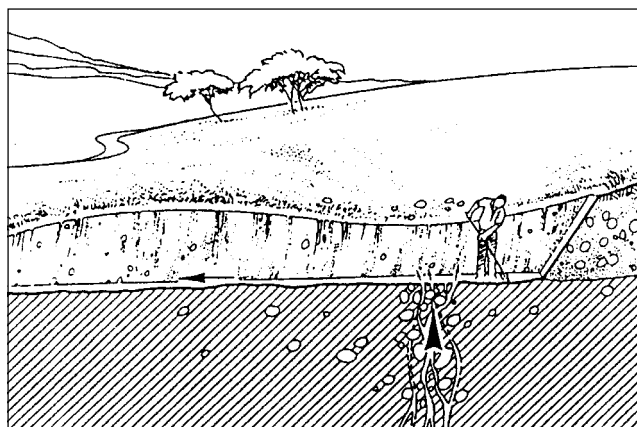

Fig. 47

- b) Secondly, excavation as far as the water table is carried out at the rising point. The area of excavation has to be slightly bigger than the planned catchment construction, so that sufficient workspace is provided.

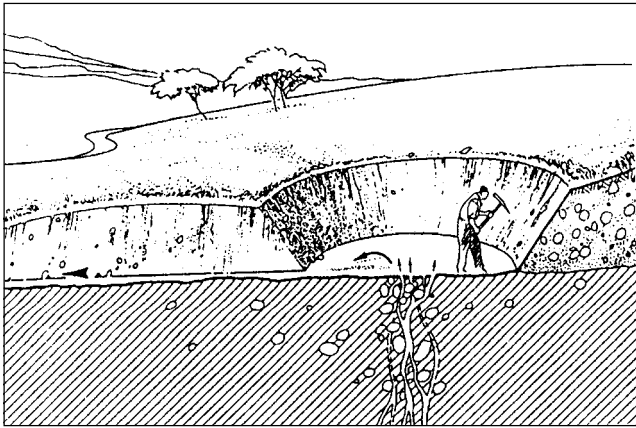

Fig. 48

- c) Since excavation in the sandy water-bearing layer leads to an immediate collapse of the side walls (because of the flow of water), excavation needs to be carried out using the caisson method. This means that the future catchment structure - in the form of a concrete ring or square box is built. Prefabricated rings or square boxes are then placed directly over the rising point before excavation can proceed below the water table.

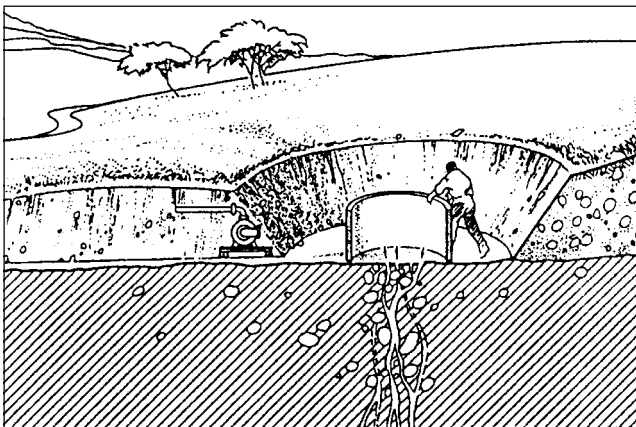

Fig. 49

- d) Excavation then resumes within the concrete ring or box in such a way that the structure sinks slowly over the rising point. As the structure sinks down, additional concrete rings or boxes (lining) are added on top. The height of the pre-cast ring structure to be sunk can only be determined during excavation. However the free flow of water must be ensured at all times - the water table inside the column must never be allowed to rise above the natural level outside the column. This may be achieved by providing drainage holes in the prefabricated construction, which are then successively locked as the

- column drops below the water table, or by syphonin out the water in the column using a flexible plastic suction pipe. If available, a motorised dewatering pump is a very effective means of removing the water from the column.

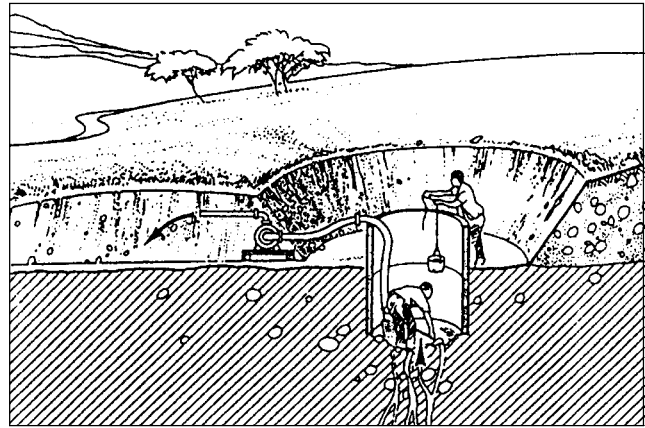

Fig. 50

- e) After completion of the excavation work, the supply pipe is cast into the column wall at the level of the lowered water table. As a precaution, an overflow pipe is normally fitted about 10 cm above the supply pipe.

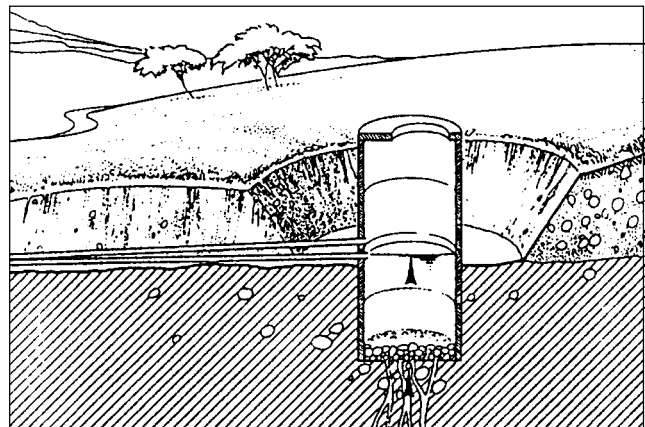

Fig. 51

- f) The permeable construction (filter package) is constructed following the recommendations detailed in section 4.3.1.4.

- g) The cover of the catchment is built following the procedure described in section 5.3.1.5.

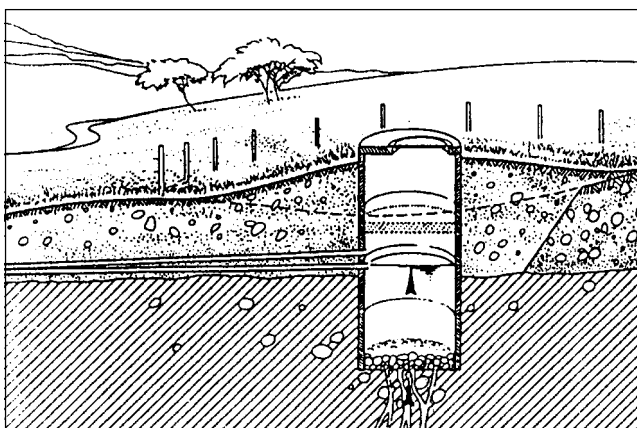

Fig. 52

Remark: For more detailed information covering the “caisson method” of excavation/construction, refer to Volume 5 of the current series of manuals, entitled “Hand-dug Shallow Wells”.

5.4 The supply pipe

5.4.0 General remarks

The supply pipe transports all of the spring flow from the catchment to the spring chamber. It is important that this pipe is able to transport the maximum spring yield without stowing back into the catchment. If a blockage in the supply pipe occurs, the spring source will build up pressure behind the catchment and then flow to another outlet of lower resistance. This may cause an irreparable failure because the source may disappear completely.

Because of the potential damage that can be caused by a blocked supply pipe, an overflow pipe is added in most cases. However, this precaution only reduces the risk of total failure if a blocked supply pipe is freed promptly. Otherwise, the overflow pipe may soon become blocked as well.

5.4.1 Design criteria

In calculating pipe diameters, keep in mind that over several years, mineral deposits or rust can significantly reduce the capacity of a pipe. Therefore with spring catchments, the hydraulic calculations to correctly dimension supply pipe section are carried out assuming an open pipe (free water level) and not as a pressure

line. This helps to avert the possibility of back stowing into the catchment, which might result in the spring disappearing.

Remark: Because the spring water emerges directly from the ground, the water in the supply pipe may still contain sand and silt even if a filter package is used.

It is important to keep the following rules in mind when designing the supply pipe:

- a) The distance between the catchment and the spring chamber should always be kept as short as possible to reduce the chance of pipe blockage.
 - b) The pipe has to be laid as straight as possible and without vertical bends in order to prevent blockage.
 - c) The minimum supply pipe gradient from the catchment to the spring chamber is 3%. The gradient should be even or gently steepening towards the outlet in order to prevent sediment build-up.
 - d) The pipe material must be selected taking the aggressivity of the water and soil into account. Detailed information is given in the “Engineering” Manual of this series.

| | |
|-------------------------------------|--------------------------------|
| – for aggressive water and/or soil | = PVC-pipes or PE-pipes |
| – for non aggressive water and soil | = GI pipes or PVC- or PE-pipes |
- Remark:** For a given diameter, a PVC pipe allows for a greater flow than a comparable GI pipe (see “Engineering” Manual of this series).

- e) The minimum diameter of the supply pipe is 50mm. If the maximum flow is not precisely known, use the next largest (above 50 mm) diameter available, or even put in two adjacent lines. Because the catchment and the spring chamber are close together, the additional expense of better pipes will not form a significant part of total project costs.
- f) It is best to install an overflow pipe. This pipe should lie 5 to 10 cm higher than the supply pipe. If the supply pipe is not flowing at the spring chamber, the caretaker knows that a failure has occurred which must be followed up promptly. The overflow pipe can only work as a safeguard if proper maintenance is carried out - overflow pipes can also become blocked over time.

The following table shows how to select a suitable pipe diameter according to spring yield.

In this table, the open pipe capacity (with a free water level) is calculated. The pipe has a gradient of 3%, and is filled to 2/3 of the height. The friction factor is chosen for GI pipes with an age of 15 to 20 years. All the numbers are rounded.

| \varnothing mm | l/sec | l/day | m ³ /day |
|------------------|-------|----------|---------------------|
| 50 | 0.85 | 73'000 | 73 |
| 65 | 1.7 | 145'000 | 145 |
| 80 | 3.0 | 255'000 | 255 |
| 100 | 5.4 | 460'000 | 460 |
| 125 | 9.8 | 840'000 | 840 |
| 150 | 16.0 | 1350'000 | 1350 |

Remark: If the gradient of the pipe is more than ten percent, select the next biggest diameter. With steep gradients and a free water level, the air-water mixture caused by turbulence reduces the capacity of the pipe.

5.4.2 Installation

It is very important to ensure that the minimum gradient of 3% is observed and that the pipeline is without any vertical bends, crests or valleys. Optionally, a slightly steepening gradient towards the outlet can be envisaged (but never the opposite!). Checking the gradient with a spirit level is highly recommended.

Routine maintenance at the spring chamber is simplified if the pipe system is installed following one of the following methods:

- a) A union is fitted outside the spring chamber such that the pipeline can be disconnected temporarily.

With this system, the supply pipe may need to be uncovered and disconnected during maintenance work. The water will then flow out above the spring chamber, and may create some problems by soaking the area.

- b) A permanent vertical T-junction is fitted outside the spring chamber, with a bypass going around the chamber and ending with a removable plug.

The water in the bypass line does not circulate and therefore should be washed out about every two months.

- c) A spare pipe can be fitted inside the chamber to create a temporary bypass which leads directly to the chamber wash-out.

This system is only possible with advanced spring chambers (see chapter 6.4.2).



Construction of a spring chamber

6.0 General remarks

Once the spring catchment is fitted with the supply pipe, the spring chamber is seen as the “eye” of the spring. If the catchment is correctly constructed with a filter package, a minimum of sand or silt will be washed out to enter the spring chamber. However, a malfunction of the catchment may lead to blockages and abrasion of the pipes that feed the storage tank and distribution system. To avoid this risk, the spring chamber is designed in such a way that larger grains (> 0.05 - 0.1 mm) are settled out.

The spring chamber is very important in that it provides the possibility for regular checkups at the spring. Every supply pipe should have a separate inlet at the inspection chamber, which allows makes for checking of the spring water.

The spring chamber has two functions:

- Main function: Allows for regular control of water quality and quantity
- Secondary function: As a sedimentation tank

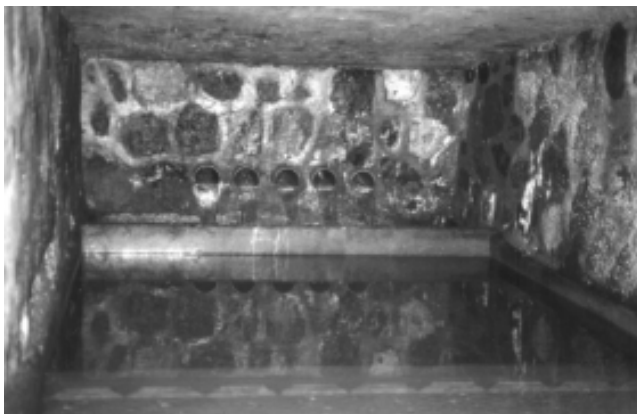

A look into the spring chamber

There are various types of spring chambers according to the layout, standard, and size of the scheme:

- Type 1. The simple inspection chamber
- Type 2. The advanced inspection chamber
- Type 3. The water point
- Type 4. The inspection manhole over the catchment

6.1 Design criteria

With spring chambers of type 1, 2 or 3, the function is the same but the configuration of the structure varies in size and complexity. The “inspection manhole

over the catchment” (Type 4) allows for regular cleaning of the catchment, which is necessary under special circumstances (see chapter 6.4.4).

Nevertheless, the following points should be kept in mind when designing any spring chamber:

- a) The exact placement of the chamber can only be fixed once the catchment and the outlet of the supply pipe have been completed. The chamber should always be as close as possible to the catchment. Hydraulic considerations should be incorporated in the decision. For example, if a sharp change in gradient occurs close to the catchment, the chamber should be situated just before the change occurs.
- b) The chamber should be large enough to ensure sufficient room for its maintenance. The basin should be calculated according to chapter 6.3.
- c) The spring chamber building must be made watertight both inside and outside.
- d) The chamber must be well ventilated. This can be achieved by setting pipes into the walls just under the ceiling which allow air to circulate. These ventilation pipes must be covered with wire mesh to prevent small animals and insects from entering.
- e) The manhole cover should be locked to prevent unauthorised persons from opening or entering the chamber and contaminating the water inside.
- f) The overflows and drains must be sized so that they are capable of draining off the maximum spring capacity without restricting the spring flow.
- g) The chamber inlet (from the catchment) must be placed 10 to 20 cm above the highest possible water level inside the spring chamber.
- h) Each water basin inside the spring chamber must be equipped with a washout (drain).

6.2 Sedimentation

The natural quality of spring water means that it is normally safe for consumption and therefore does not require any treatment. However, since seasonal peaks in the flow through the water-bearing layer may occasionally lead to some turbidity in the water, a simple method for reducing sediments is given below.

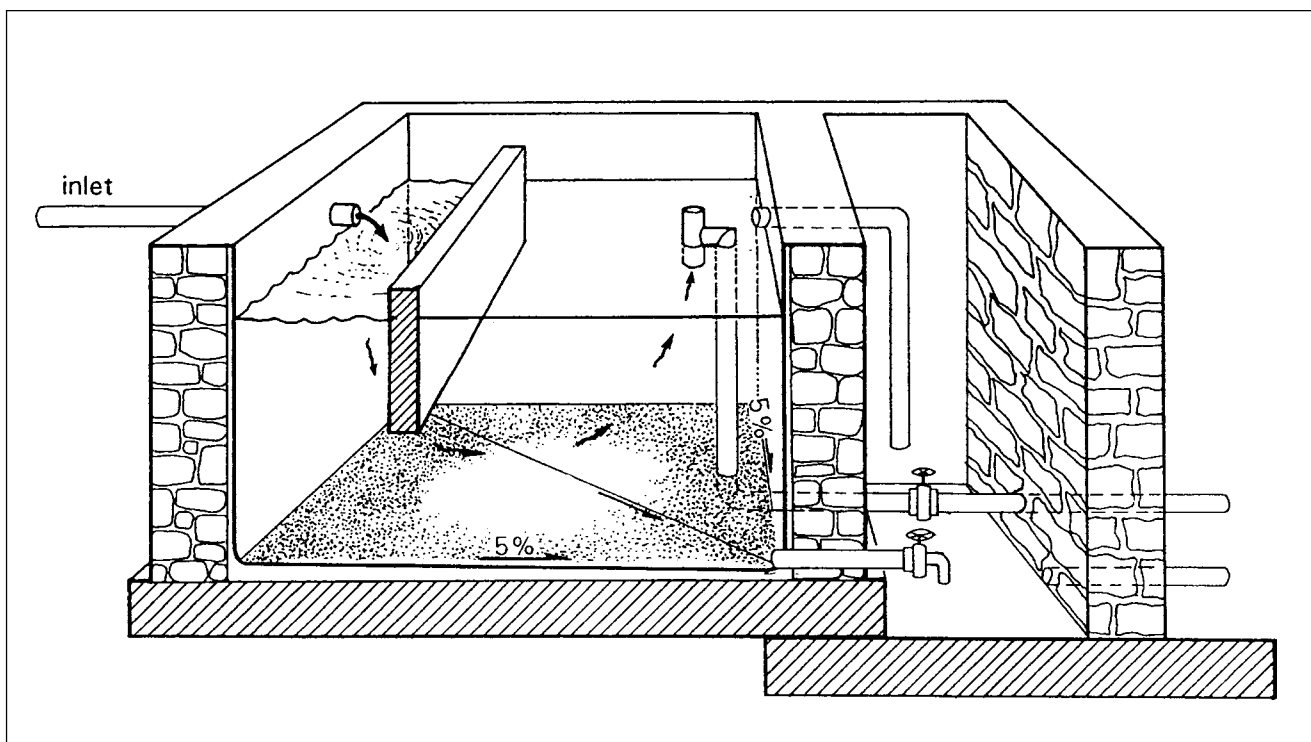

Fig. 53

Sedimentation is the term used to describe the settling out of suspended particles that takes place when water flows slowly through a basin.

Due to the low velocity of flow across the basin, and in the absence of turbulence, particles having a mass density (specific weight) higher than that of the water are eventually deposited at the bottom of the chamber, forming a sludge layer. The velocity of the flow must be reduced to such a degree that the water reaching the chamber outlet is clarified to an acceptable limit. Very fine substances or dissolved chemicals cannot be settled out using this technique.

The topic of sedimentation is a large one. More detailed information about sedimentation, together with information on water treatment in general, is given in the "Engineering" manual of this series.

6.3 Designing the size of the water basin

As mentioned earlier, the function of the spring chamber is not only to keep an eye on water quality and quantity, but also to function as a sedimentation tank for particles of sand and silt. Some springs carry a good deal of fine and/or large grained sediments and

others carry very little. Some springs only carry sediment during rainy seasons, others constantly. Therefore, it is important to understand the characteristics of the source before designing the spring chamber.

6.3.1 Calculation of the required dimensions

In order to allow sufficient time for suspended sand and silt to sink to the bottom of a basin, the velocity of the water passing through the basin must be controlled. Up to a point, the longer the water is retained quietly in the chamber (retention-time), the more time is made available for suspended particles to sink and settle.

For a given tank volume, a tank with a larger top surface area has a lower volume of water passing through per unit of surface area (i.e. less depth for given volume), and so less time is required for a particular sand or silt grain to travel to the bottom of the tank. It follows that for a given flow travelling through a settling tank of fixed volume, a shallower tank with a large water surface is more effective at clarifying than a deeper tank with a smaller surface area. For a particular flow, a source carrying a lot of fine sand and silt therefore requires a spring chamber with a larger water surface area than would be required for a comparable flow carrying only coarse sediments.

For design purposes, settling tanks are characterised by "surface load", which is defined as the flow of water passing through each square metre of top surface. The table below shows the recommended sizes of water basins for a range of maximum spring yields. The method of calculation is described in the "Engineering" manual of this series. The values given are a rule of thumb, assuming average turbidity, a retention time of 15 to 20 minutes and a surface load of 2 - 2,5 meters per hour. Because turbidity is normally higher during maximum yield, the design of the water basin should accommodate conditions of maximum spring flow.

| <i>Q max</i> in lit/sec | <i>Area of</i> <i>surface</i> in m ² | <i>Inside measurement</i> <i>for the water basin in m1</i> | | |
|-------------------------------|---|---|---------------|--------------|
| | | <i>width</i> | <i>length</i> | <i>depth</i> |
| 0.5 | 1.0 | 0.65 | 1.50 | 0.5 - 0.6 |
| 1.0 | 1.5 | 0.75 | 2.10 | 0.6 - 0.75 |
| 2.0 | 3.0 | 1.00 | 3.00 | 0.8 - 0.95 |
| 3.0 | 4.6 | 1.00 | 4.60 | 0.9 - 1.15 |
| 4.0 | 6.2 | combination of chambers from above | | |
| 5.0 | 7.7 | combination of chambers from above | | |

Remark: If the difference between the minimum and maximum yield is very high and the source is needed to guarantee supply, the basin can be built to a more economic size than that required by maximum yield conditions, especially if the overflow is placed close to the inflow.

6.3.2 Design Criteria

The efficiency of the sedimentation process depends on other key configuration criteria. The basin must be designed in such a way that uniform flow exists through the tank and the water must not "short circuit" the retention period by flowing straight from the inlet directly to the outlet. Therefore the following measures are recommended:

- A baffle plate is placed close to the inlet to reduce turbulence and ensure uniform flow.
- A depth to length ratio of between 1:4 and 1:10 should be respected.
- In the case where sedimentation is constantly required, the outlet has to be arranged in such a way that the desired surface level is maintained.
- In all other cases, the outlet has to be placed well above the sludge zone (typically 25 - 30 cm) and should normally be protected with a fine strainer.

6.4 The 4 different types of spring chambers

Information regarding detailed construction procedures can be found in the "Building Construction" publication in this series of manuals. A brief description of the construction of the four main types of spring chamber follows below.

6.4.1 The simple inspection chamber

This chamber has a very simple layout. All the necessary inspections can be carried out using the cast iron manhole cover. The simple inspection chamber can be used for springs with a yield of up to a few thousand litres per day, or roughly between 2 - 20 litres per minute.

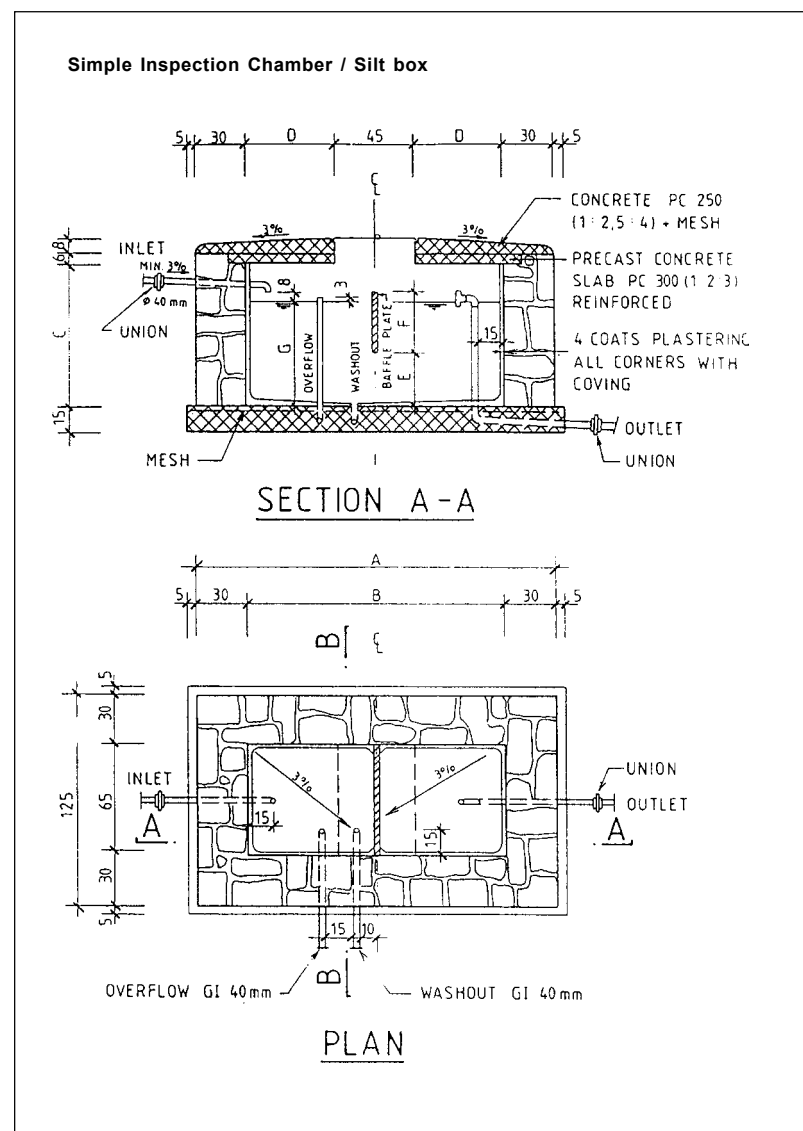

Fig. 54

The advantages of this structure are the simple design and the small size of the construction. Usually, springs in rural settings are small and far away from villages and access roads. This simple design requires much less material than an advanced inspection chamber. A disadvantage of the design is that the manhole cover is sited directly above the water basin, which should generally be avoided. It is therefore important to use watertight covers to prevent contamination seeping in

to the chamber. Also of potential concern, the chamber can be easily polluted during check-up maintenance. However, it is also true that even the best technical layout cannot guarantee safe water if the maintenance personnel do not work properly and carefully.

Like the advanced inspection chamber, this chamber can be built with a second basin that functions as a collection chamber.

6.4.2 The advanced inspection chamber

The advanced inspection chamber is used in large water schemes with spring yields of several tens of thousands of litres per day (i.e. more than 20 liters per minute).

As shown in the illustration, the advanced inspection chamber actually consists of at least two chambers. One chamber is for the water and the other is an inspection and operation room for the waterminder. The entrance is either through the roof or from the front side. If the entrance is made through the roof, it should be situated over the operation chamber and not directly over the water. This is important so that no dirt is dropped into the water when climbing down into the chamber. This structure can be enlarged with an additional second or a third water basin. The additional basins function as collection chambers for springs coming from different areas which are connected to the supply.

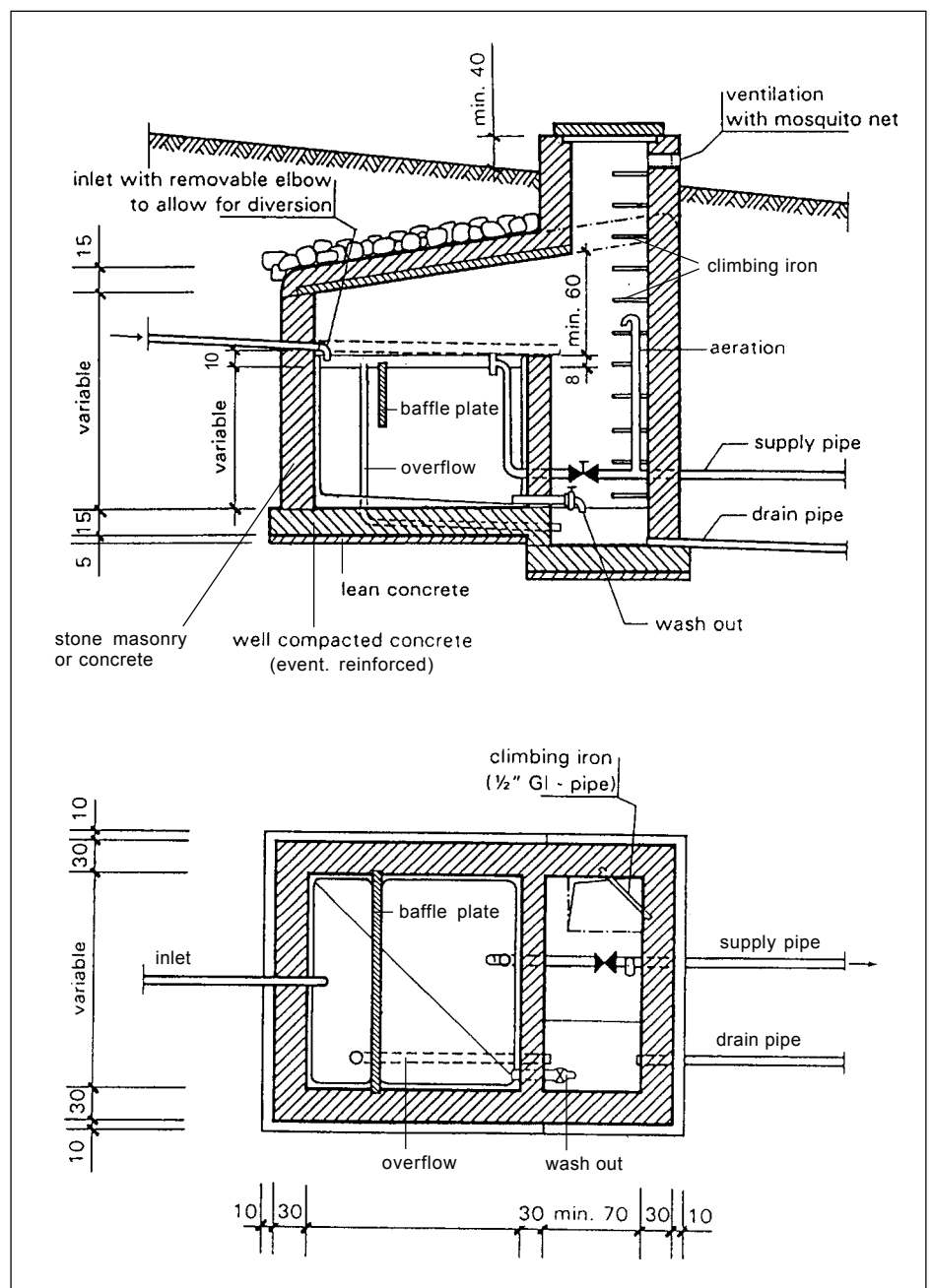

Fig. 55

6.4.3 The water point

The water point consists of a storage tank, a tap and possibly a wash basin. Water points can be built for any small spring with a minimum (dry season) yield of one litre per minute. A difference in height of at least 1.0 m is required between the catchment and the outlet of the storage chamber.

The construction of a water point serves as a sedimentation basin, and to store water during the night for use in the daytime.

The volume calculation is performed as it is done for storage tanks (see the "Engineering" manual of this series). This means that if the yield of the spring

amounts to 5 liters per minute and water should be stored over a maximum night-time period of 10 hours, the required volume of the storage tank above the outlet tap amounts to $(5 \times 60 \times 10) = 3'000$ liters.

If the spring supplies more than 15 l/minute in the dry season and the water demand is low, there is no need for a storage tank. A wash-basin into which the water enters directly from the catchment can be built. The main disadvantage of this system is that people trying to improve the flow may inadvertently block the outlet pipe. Such a blockage carries risks discussed earlier - the spring may pressurise back into the catchment and disappear. An overflow pipe at the catchment may ease this problem to some degree.

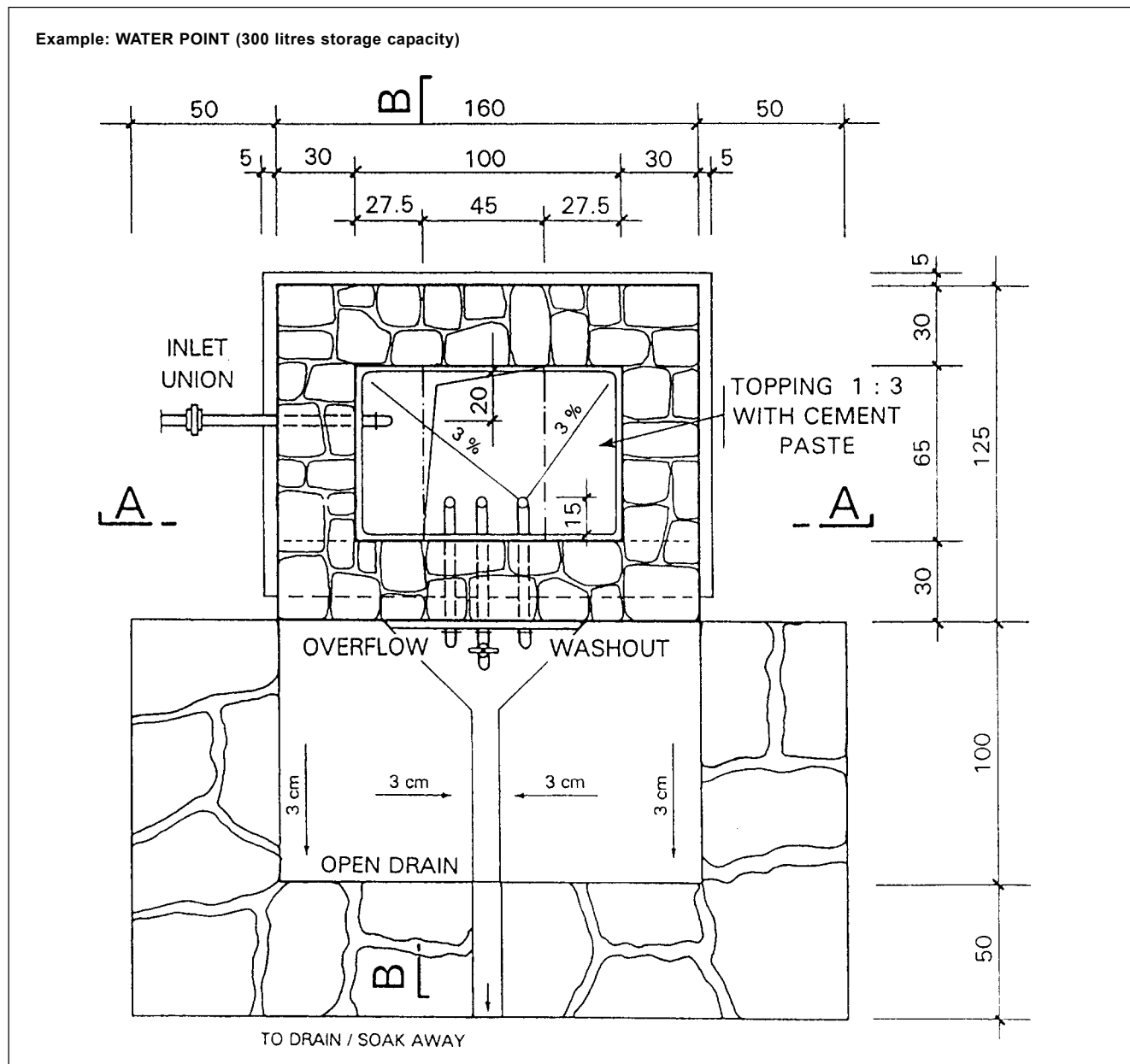

Fig. 56-1

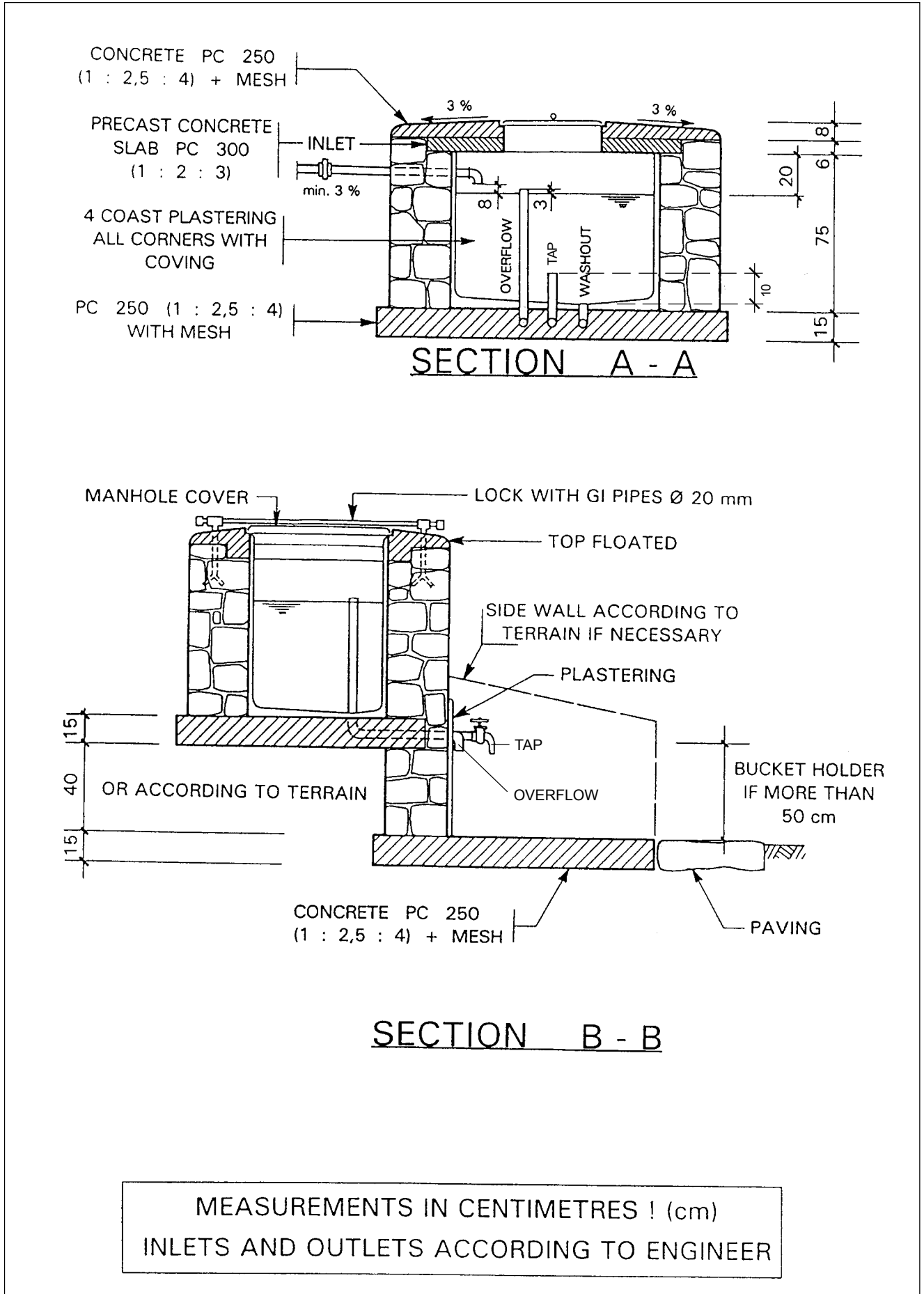

Fig. 56-2

6.4.4 The inspection manhole at the catchment

A less common design of inspection chamber is the "inspection manhole over the catchment" type.

This manhole is required if frequent blockage of the catchment is anticipated. In some areas, rapid growth

of certain vegetation can result in frequent blockage of the supply pipe with plant roots. The possibility of frequent unblocking by hand may be the only way to ensure that the catchment retains its functionality over time. Direct access to the catchment is therefore required in such cases to allow regular maintenance of the catchment. A catchment with an inspection manhole still requires a separate spring chamber as described earlier.

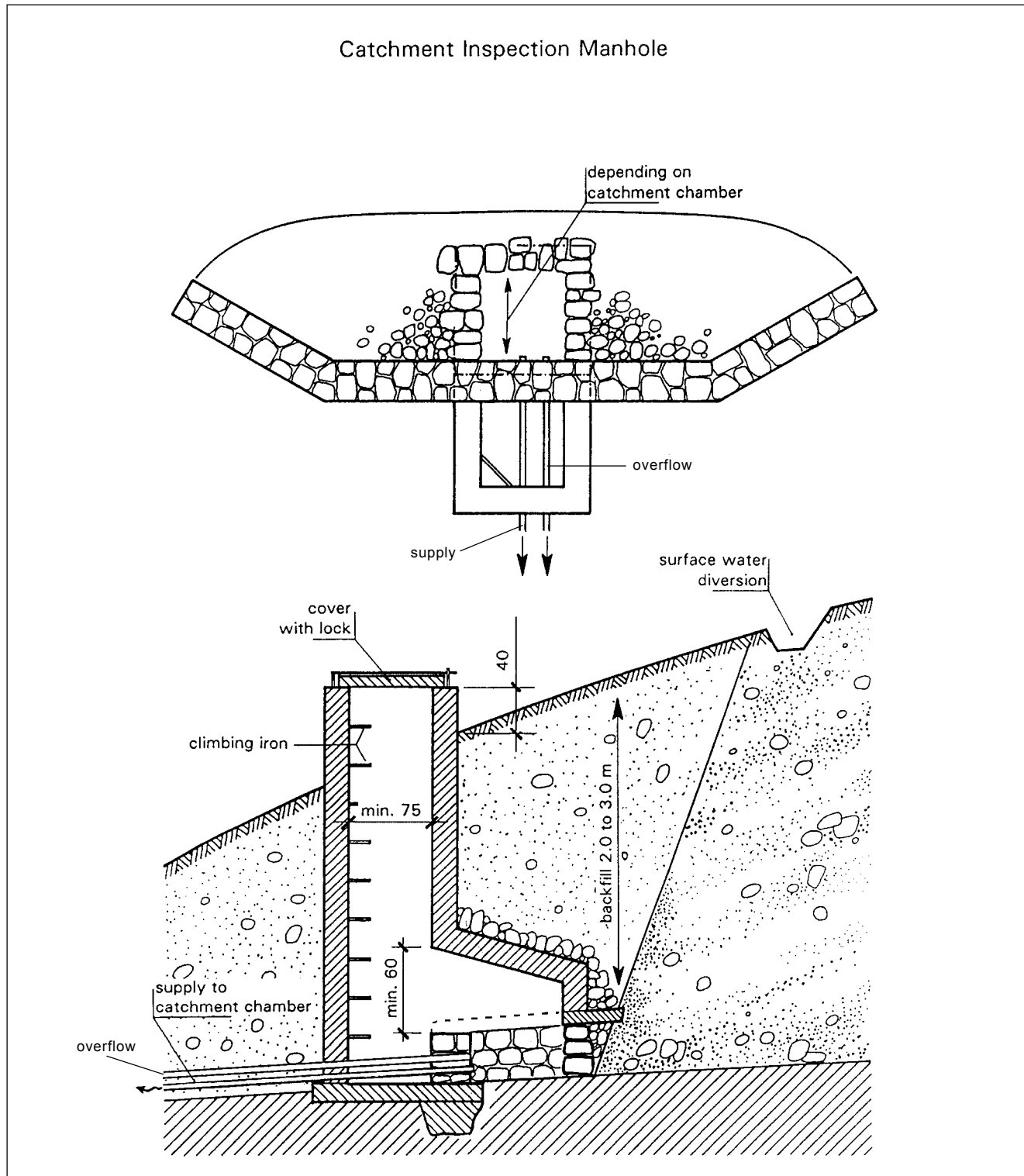

Fig. 57



Latrines can be good things but not in the intake area

7.0 Twenty Common mistakes made on spring catchments

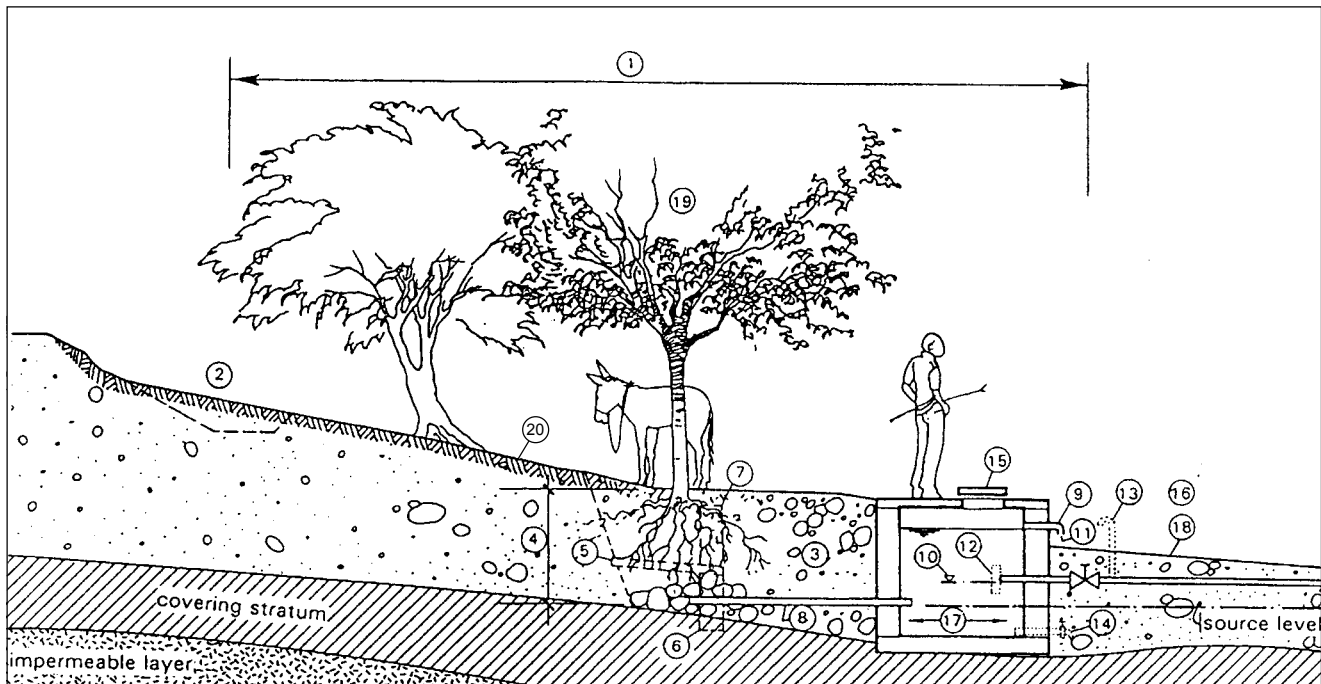

Fig. 58

- 1 no protection zone and no fence
- 2 no surface water drainage
- 3 loose, permeable material used for backfilling; backfilling too high, surface water can flood the spring chamber (chamber entrance too low)
- 4 thickness of the earth cover over the spring is inadequate
- 5 no concrete protection cover (5cm)
- 6 no barrage has been built to prevent water from bypassing the supply pipe.
- 7 in cases where a barrage wall has been constructed, it may well have been built too high. If the top of the wall is significantly higher than the normal level of the source, infiltrated surface water may be re-directed into the catchment.
- 8 supply pipe diameter is too small; gradient is too flat
- 9 the position of the overflow too high (it should lie below the source level)
- 10 the position of the outlet is too high (it should be below the source level)
- 11 no wire-mesh covering the overflow
- 12 no strainer used (danger of blockage!)
- 13 no aeration after valve (vacuum!)
- 14 no wash out
- 15 chamber entrance should preferably be above ground level (danger of contamination by infiltration and seepage) and not directly above the water reservoir (danger of contamination by droppings when entering)
- 16 no combined chamber for maintenance and valve operation. No baffle plate between inlet and outlet.
- 17 no plastering (water seal)
- 18 overflow water not drained
- 19 trees planted too close to catchment
- 20 no grass planted to prevent erosion



A busy but well maintained water point

8.0 Operation and Maintenance

Spring catchments need very little operation and a lot less maintenance than other catchment systems because there are no mechanical installations necessary for the water development.

A simple design combined with high quality construction for all structures in the catchment area will keep maintenance requirements to a minimum. Even so, all spring catchments need a periodic checkup. To ensure that water quality stays good and that there are no operational problems at the catchment, a monthly control is vital.

The following points have to be checked during regular visits to the catchment area:

At the protection zone

- a) The fence of the protection area
- b) The diversion drainage above the catchment
- c) Wet spots indicating a leakage from the catchment
- d) Trespass such as prohibited farming in the intake area

At the spring chamber

- a) Leakage at the chamber
- b) The manhole cover
- c) Blockage at the supply line - water comes through the reserve (overflow) pipe
- d) The ventilation
- e) The water quality and quantity (tested without equipment)
- f) Sedimentation in the chamber
- g) If possible measure the yield of the spring and compare it with data of previous years

Minor jobs can be carried out immediately by the waterminder during regular visits. If there are bigger problems, for example wet spots around the catchment or leaks at the spring chamber, the water committee or the responsible technician should be informed.

Remark: The supply pipe must never be plugged during any maintenance work at the spring chamber because this will damage the catchment (see chapter 5.4.2).

These periodic checkups may be reported and controlled by filling out simple forms (checklists) that are completed at every visit. The condition of the structures and weak spots in the water supply can be evaluated and documented through by using such forms. A properly kept documentation can be of great help in developing a appropriate design standards and construction techniques for future projects.



Easy accessible operation chamber – well maintained



Catchment of contact spring with a "catchment trench"

9.0 Reference Books and useful websites

- Jordan, T. D., (Jnr), 'A handbook of gravity-flow water systems for small communities', IT Publications, London, 1984.
- GRET/AFVP, 'Le point sur le captage des sources (Dossier No. 10)', GRET, Paris, 1987.
- Drouart, E., Vouillamoz, J-M., 'Alimentation en eau des populations menacées', Action Contre la Faim, Hermann, Paris, 1999.
- Davis, J. & Lambert, R. 'Engineering in Emergencies', RedR, IT Publications, London 1995.
- Chartier et al., 'Public Health Technician in precarious situations', Delmas G., & Courvallet M., (eds.), MSF, Paris 1994.
- Hofkes. E.H. (ed.), 'Small Community Water Supplies: Technology of Small Water Supply Systems in Developing Countries', IRC Technical Paper No. 18, Wiley & Sons, Chichester, 1983.
- Helvetas, 'Design, construction and standardisation of gravity water supply systems in rural villages in Sri Lanka', Helvetas, Zürich, 1994.
- Shaw, R., and Skinner, B. 'Technical Brief No.34. Protecting springs – an alternative to spring boxes'. In 'Running water: more technical briefs on health, water & sanitation', Shaw, R. (ed.), IT Publications, London, 1999.
- Rous, T., 'Protecting a shallow seepage spring', *Waterlines*, Vol.4 No.2, IT Publications, London, 1985.
- Tobin, V., and Carncross, S. 'Technical Brief No. 3: Protecting a spring', *Waterlines*, Vol.3 No.3, IT Publications, London, 1985. In 'The worth of water: technical briefs on health, water & sanitation', IT Publications, London, 1991.
- Lloyd, B. and Helmer, R., (1991), *Surveillance of Drinking Water Quality in Rural Areas* (London/New York, Longman for WHO and UN Environment Programme)
- World Health Organisation, (1993), *Guidelines for Drinking Water Quality, 2nd ed., Vol. 1 - Recommendations* (Geneva, WHO)
- World Health Organisation, (1993), *Guidelines for Drinking Water Quality, 2nd ed., Vol. 3 - Surveillance of Community Supplies*
- Swiss Development Corporation (SDC), *Water and Sanitation Sector Policy*, (SDC, Berne)