

# Water Harvesting

Guidelines to Good Practice

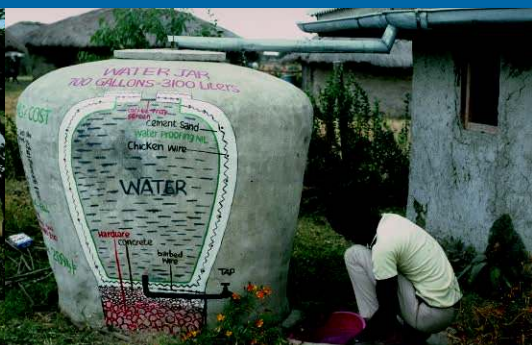

**Water Harvesting**  
Guidelines to Good Practice



# Water Harvesting

Guidelines to Good Practice



## Funded by



Co-published by	Centre for Development and Environment (CDE) and Institute of Geography, University of Bern; Rainwater Harvesting Implementation Network (RAIN), Amsterdam; MetaMeta, Wageningen; The International Fund for Agricultural Development (IFAD), Rome
Financed by	The International Fund for Agricultural Development (IFAD), Rome and Swiss Agency for Development and Cooperation, Berne (SDC)
Authors	Rima Mekdaschi Studer and Hanspeter Liniger (Centre for Development and Environment, CDE)
Contributors	Rudolph Cleveringa (The International Fund for Agricultural Development, IFAD) Robert Meerman and Maarten Onneweer (Rainwater Harvesting Implementation Network, RAIN) Frank Steenberg and Lenneke Knoop (MetaMeta) Julie Zähringer and Zarina Osorova (Centre for Development and Environment, CDE)
Case study authors and compilers	Haile Abraham Mehari, Daniel Dale Danano, Joris de Vente, Mongi Ben Zaied, Mohamed Ouessar, Houcine Yahyaoui, Heinz Bender, VK Agrawal, David Gandhi, Ian Neal, Maimbo Malesu, Sabina Vallerani, Donald Thomas, Kithinji Mutunga, Joseph Mburu, Oudou Noufou Adamou, Francis Turkelboom, Julius Althopheng, Madhav Dhakal, Daler Domullojonov, Sa'dy Odinašoev
Technical and language editor	William Critchley (Sustainable Land Management Associates)
Figures	Dominique Liniger, Simone Kummer
Layout	Simone Kummer, Cinzia de Maddalena
Printed by	K-print, Tallinn, Estland
Citation	Mekdaschi Studer, R. and Liniger, H. 2013. Water Harvesting: Guidelines to Good Practice. Centre for Development and Environment (CDE), Bern; Rainwater Harvesting Implementation Network (RAIN), Amsterdam; MetaMeta, Wageningen; The International Fund for Agricultural Development (IFAD), Rome.
Copyright	© 2013 by the International Fund for Agricultural Development (IFAD) All rights reserved. Reproduction and dissemination of material in this product for educational or other non-commercial purposes are authorized without any prior written permission from the copyright holder provided the source is fully acknowledged. Reproduction of material in this product for commercial purposes and/or monetary gain is prohibited.
Cover photos	HP. Liniger and C. Studer

ISBN 978-3-905835-35-9  
Geographica Bernensia, Bern

#### Co-publishers' information

University of Bern – CDE	Rainwater Harvesting Implementation Network (RAIN)	MetaMeta Research/Management	International Fund for Agricultural Development (IFAD)
Hallerstrasse 10	Barentsplein 7	Paardskerkhofweg 14	Via Paolo di Dono, 44
3012 Bern	1013 JN Amsterdam	5223 AJ 's-Hertogenbosch	00142 Rome, Italy
Switzerland	The Netherlands	The Netherlands	www.ifad.org
www.cde.unibe.ch	www.rainfoundation.org	www.metameta.nl	ifad@ifad.org
info@cde.unibe.ch	info@rainfoundation.org	fvansteenbergen(at)metameta.nl	

#### Disclaimer

The opinions expressed in this publication are those of the authors and do not necessarily represent those of the International Fund for Agricultural Development (IFAD) or the Swiss Agency for Development and Cooperation (SDC). The designations employed and the presentation of material in this publication do not imply the expression of any opinion whatsoever on the part of IFAD or of SDC concerning the legal status of any country, territory, city or area or of its authorities, or concerning the delimitation of its frontiers or boundaries. The designations 'developed' and 'developing' countries are intended for statistical convenience and do not necessarily express a judgment about the stage reached by a particular country or area in the development process.

# Table of contents

Foreword	VII
Preface	IX
<b>Part 1: Water Harvesting Classified</b>	
Introduction	1
Definition of water harvesting	4
Aim of water harvesting	4
Principle, concept and components	5
Water harvesting as part of integrated water resource management	6
Classification and categorisation	7
Benefits and constraints: the pros and cons of water harvesting	13
What works where and when	15
Adoption and upscaling	18
Planning	21
Conclusion	23
References Part 1	24
<b>Part 2: Water Harvesting Applied</b>	
Introduction	29
<b>Floodwater harvesting</b>	<b>33</b>
Spate irrigation, Eritrea	45
Runoff and floodwater farming, Ethiopia	49
Water harvesting from concentrated runoff for irrigation purposes, Spain	53
Water spreading weirs for the development of degraded dry river valley, Chad	57
Jessour, Tunisia	63
Tabia, Tunisia	67
<b>Macro-Catchment Water harvesting</b>	<b>71</b>
Sunken streambed structure, India	91
Small Earth Dams, Zambia	95
Sand dams, Kenya	99
Recharge well, Tunisia <sup>105</sup>	
<b>Micro-Catchment Water harvesting</b>	<b>109</b>
Planting pits and stone lines, Niger	123
Furrow enhanced runoff harvesting for olives, Syria	127
Vallerani system, Burkina Faso	131
Fanya juu terraces, Kenya	137
<b>Rooftop and Courtyard Water harvesting</b>	<b>141</b>
Roof rainwater harvesting system, Botswana	159
Rooftop rainwater harvesting system, Nepal	163
Roof top rainwater harvesting stored in a polythene lined earth retention tank, Tajikistan	167
Rooftop rain water harvesting – concrete tank, Tajikistan	171
<b>Annex</b>	
Annex 1: Different definitions of water harvesting	179
Annex 2: End use of harvested water – what is appropriate where	180
Annex 3: Improved water availability and development issues addressed by water harvesting (WH)	181
Annex 4: Networks and Events	182
Annex 5: A classification of the literature reviewed and references cited	186



# Foreword

Water harvesting has been practiced successfully for millennia in parts of the world – and some recent interventions have also had significant local impact. Yet water harvesting's potential remains largely unknown, unacknowledged and unappreciated.

It is time to scale-up the 'good practices' of water harvesting that have survived or emerged from new experience, after decades of almost exclusive focus on mastering fresh water flows in rivers and lakes through investments in irrigation infrastructure. Water harvesting offers under-exploited opportunities for the predominantly rainfed farming systems of the drylands in the developing world. It works best in precisely those areas where rural poverty is worst. When practiced well, its impact is to simultaneously reduce hunger and alleviate poverty, as well as to improve the resilience of the environment.

The principle is simple: capture potentially damaging rainfall runoff and translate this into plant growth or water supply. This makes clear sense where rainfall is limited, uneven or unreliable with pronounced dry spells. Yet despite these rainfall limitations, runoff occurs due to high intensity showers and the low water holding capacity of fields, pastures, and forests. And with the impacts of climate change already with us, here is an approach to better use a local resource for livelihood sustenance. These practical guidelines offer a menu of technologies that can form part of an overall adaptation strategy for rural people: farmers and nomads, women and men. Rainwater harvesting technologies presented in these guidelines are flexible and if needed can be adjusted to the local context while being embedded into institutional frameworks.



Kevin Cleaver

Associate Vice President  
Programme Management Department  
International Fund for Agricultural Development (IFAD)

The International Fund for Agricultural Development (IFAD) and the Swiss Agency for Development and Cooperation (SDC) have come together to present water harvesting in a way that makes good practice both understandable and accessible. These guidelines are intended to inform decision-makers and donors, but are mainly geared to be of direct use to practitioners in the field, all the way up to watershed and river basin planners. A wide span of technologies are covered: these range from large-scale floodwater spreading that make alluvial plains cultivable, to systems that boost crop, fodder and tree production in small farms, as well as practices that collect and store water from household compounds.

There is a hidden wealth of knowledge about these water harvesting technologies, and the settings in which they tend to perform best. This is the first time this knowledge has been uncovered, collated and made available in such an organized, illustrated and informative way – linking technologies to the knowledge networks that will serve the intended users of these practical guidelines to better understand and implement their choices.



Michel Mordasini

Assistant Director General  
Swiss Agency for Development and Cooperation (SDC)





# Preface

These guidelines provide an overview of proven good practice in water harvesting from all over the world. They form a practical reference guide while providing support and specific technical expertise for the integration of water harvesting technologies into the planning and design of projects. Thus existing information and experience is strengthened.

On a broader scale, the guidelines' objective is to facilitate, share and upscale good practice in water harvesting given the state of current knowledge. Targeted end users include local and regional planners / advisors, rural development consultants, rainwater harvesting networks and communities-of-practice, project managers, extension agents and other implementing staff. Through informing these professionals, the aim is to stimulate discussion and new thinking about improved water management in general, and water harvesting in particular, within rainfed agriculture, particularly in the drylands. The ultimate goal is to contribute to lifting 80 million rural people out of poverty by 2015: water security is a prerequisite to achieve food security for these people.

In Part 1 of these guidelines the concepts behind water harvesting are introduced and a working definition proposed. This then leads to the development of a harmonised classification system. It is followed by an assessment of suitability, adoption and upscaling, and reflections on planning of water harvesting. In Part 2, we provide an overview of four water harvesting groups (or "categories") and, for each, give a selection of good practice in the form of case studies. These case studies are presented in the systematic, consistent and standardised format developed by the World Overview of Conservation Approaches and Technologies (WOCAT).

# Part 1







HP. Tinigei

# Part 1: Water Harvesting Classified

## Introduction

*“The greatest potential increases in yield are in rainfed areas where many of the world’s poor live and where managing water is the key to such increases” (Molden, 2007).*

Currently, of the 1.5 billion hectares of cropland worldwide, more than 80 percent depend on rainfall alone, contributing to at least two-thirds of global food production (FAOSTAT, 2005 in Rockström et al., 2007; Scheierling, 2011). While the coverage of rainfed agriculture varies regionally (Box 1), in developing regions including Latin America and Sub-Saharan Africa more than 90 percent of cropland is rainfed.

According to FAO, the population of the least developed countries in the world is still predominantly rural: nearly 70 percent reside in the countryside (FAOSTAT, 2012). Despite massive progress in reducing poverty in some parts of the world, over the past two decades – notably in East Asia – there are still about 1.4 billion people living on less than US\$1.25 a day, and close to 1 billion people currently suffer from hunger (IFAD, 2011). The majority of the rural poor affected by food insecurity can be found in semi-humid and semi-arid areas, as illustrated in Figures 1 and 2. These areas are especially dependent on rainfed agriculture, and global increases in food prices can exacerbate food insecurity. But these challenges simultaneously provide opportunities. With the rise of market prices and increased knowledge about productive sustainable land and water management systems, these areas have the potential to become at least self-sufficient, or even net exporters of food (see Tiffen, Mortimore and Gichuki, 1994, for a well-known example from Eastern Kenya).

Rainfed agriculture is practiced in almost all the agro-ecological / hydro-climatic zones of the world. Yields can be high in temperate regions, with relatively reliable rainfall and productive soils; and also in tropical regions, particularly in the sub-humid and humid zones. But in drylands, which cover approximately 40 percent of the global land area (excluding Greenland and Antarctica, Box 2), yields of the major crops tend to be relatively low; between a quarter and half of their potential (Rockström et al., 2007; Wani et al., 2009; Scheierling et al., 2013).

### Box 1: Approximate percent of cropland that is rainfed

Region	%
Latin America	90
Middle East and North Africa	75
East Asia	65
South Asia	60
Sub-Saharan Africa	95

(FAOSTAT, 2005 in Rockström et al., 2007; Scheierling et al., 2013).

### Box 2: Regional extent of drylands (in 000 km<sup>2</sup>)

Region	Aridity Zone							
	Arid	%	Semi-Arid	%	Dry Sub-Humid	%	All Drylands	%
Asia (incl. Russia)	6,164	13	7,649	16	4,588	9	18,408	39
Africa	5,052	17	5,073	17	2,808	9	12,933	43
Oceania	3,488	39	3,532	39	996	11	8,016	99
North America	379	2	3,436	16	2,081	10	5,996	28
South America	401	2	2,980	17	2,233	13	5,614	32
Central America & Caribbean	421	18	696	30	242	10	1,359	58
Europe	5	0	373	7	961	17	1,339	24
World Total	15,910	12	23,739	18	13,909	10	53,558	40

(in WRI, 2012)



HP. Liniger



HP. Liniger

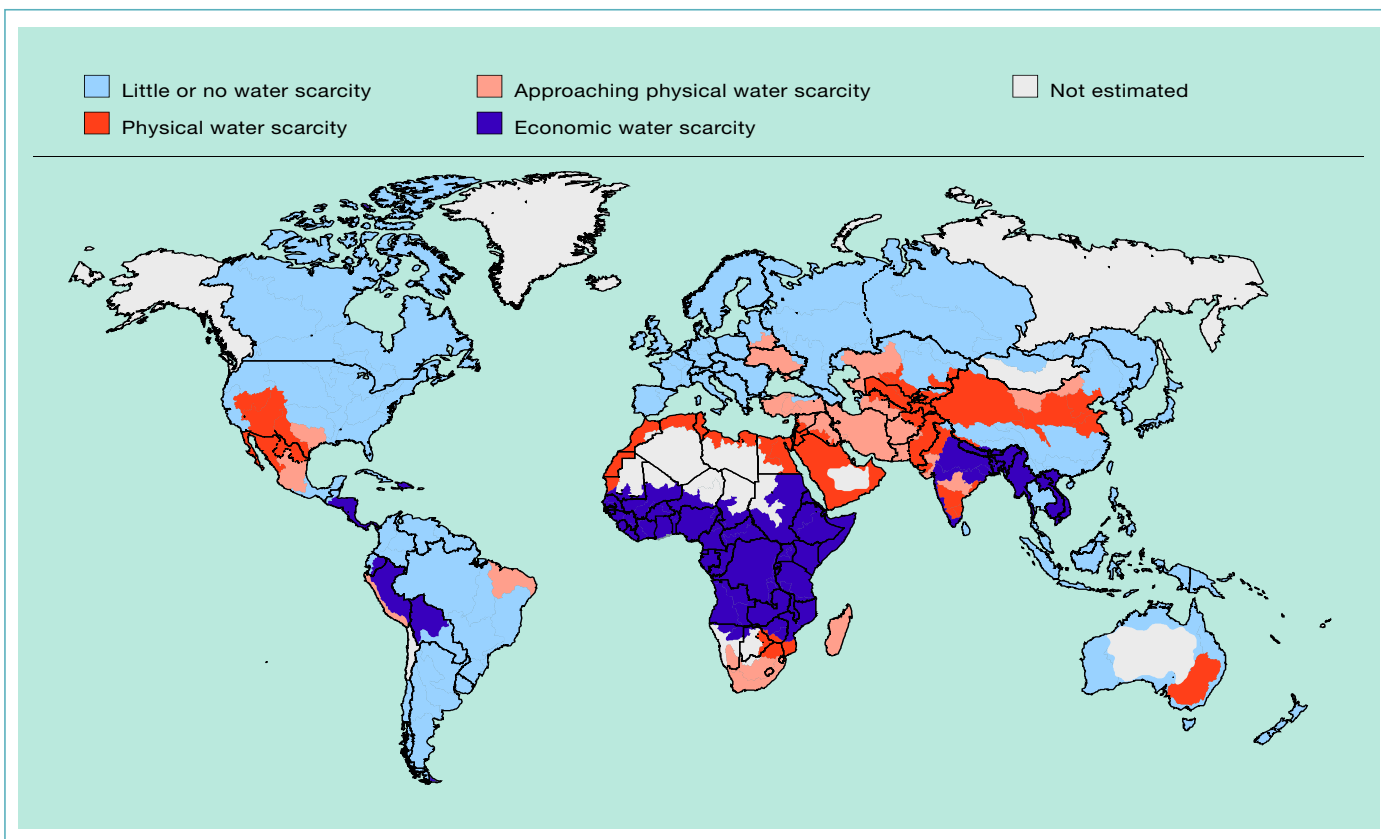

Figure 1: Areas of physical and economical water scarcity at a basin level in 2007 (in IWMI, 2008).

Challenges within rainfed farming are many in arid, semi-arid, sub-humid and even in humid regions. Water for production continues to be a key constraint to agriculture, due to highly variable rainfall, long dry seasons, and recurrent droughts, as well as floods. If rainfall is less than crop water requirements, then clearly actual yields will be less than the potential; moreover the impact of variable rainfall is strongly affected by the nature of the soil and the stage of the growing period (Critchley and Scheierling, 2012).

In addition climate change will affect these regions, where livelihoods are largely rainfed, and cereal or livestock farming system based. Recent climate change scenarios project that between 2000 and 2050, and for warming levels of 1.8°C to 2.8°C (2.2°C to 3.2°C compared to preindustrial temperatures), decreases in yields of 14 to 25 percent for wheat, 19 to 34 percent for maize, and 15 to 30 percent for soybean (without accounting for possible CO<sub>2</sub> fertilization effects (Deryng et al., 2011).

Beside the challenges of coping with water scarcity and stress due to climatic variability, land degradation resulting from soil erosion by wind and water, and poor management of soil fertility contributes to low rainwater use efficiency. Poor land and water management practices are major causes of low crop productivity. Up to 70 – 85 percent of rainfall may be effectively “lost” to crops in the drylands of Sub-Saharan Africa (Rockström, 2000; Rockström et al., 2007; Liniger et al., 2011). Water in an agricultural production system can be lost due to evaporation from the soil surface, surface runoff (which simultaneously causes erosion) and through deep percolation / drainage, which sometimes can be later recovered for irrigation elsewhere (see Figure 3).

These rainfall losses, however, can be transformed into productive “green water”: meaning soil water directly used by transpiration for plant growth (Figure 3). Then losses become advantages: runoff feeds water harvesting systems that store water directly in the soil profile. Losses can also



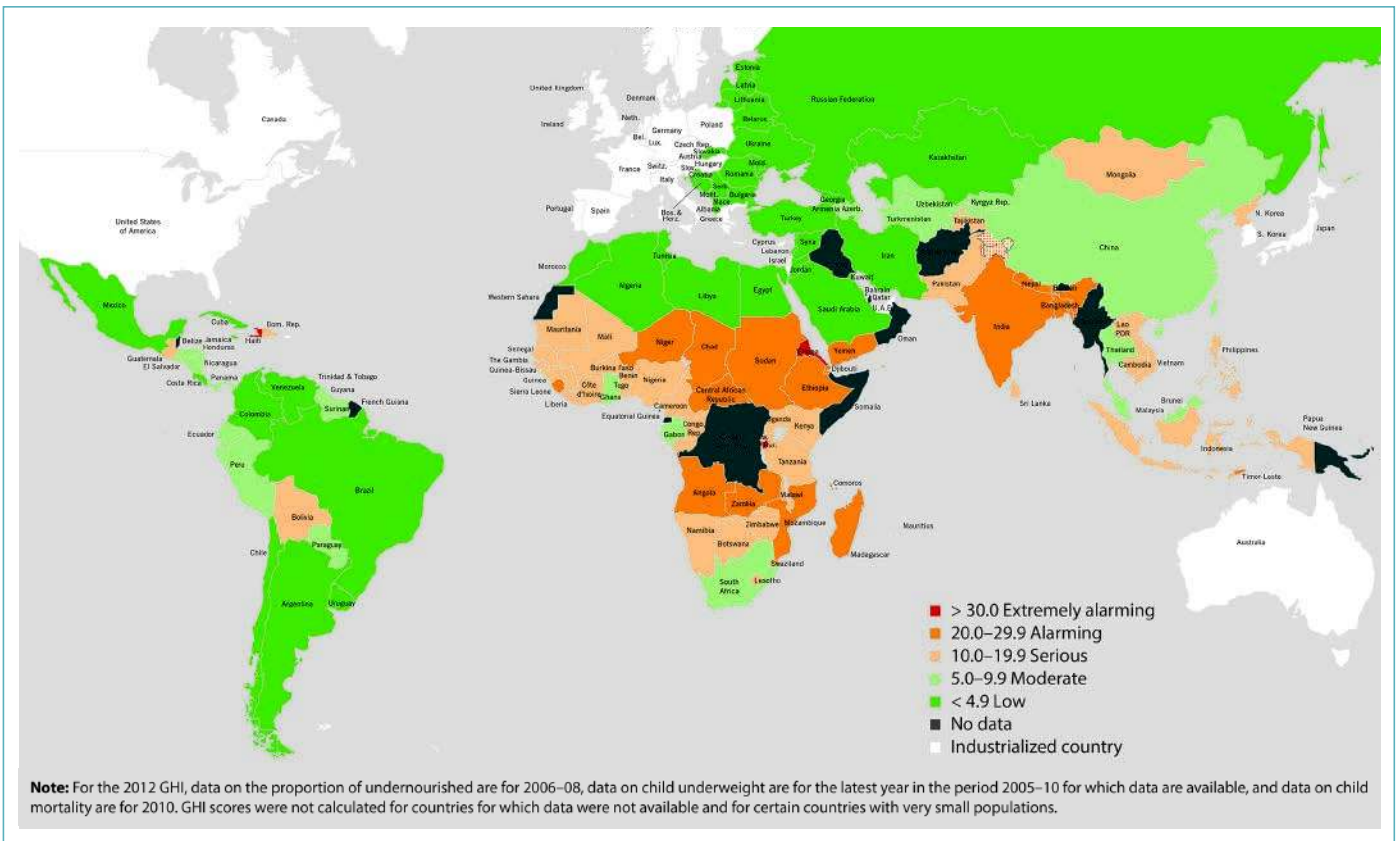

Figure 2: Global Hunger Index (GHI) scores by severity for 2012 (Von Grebmer et al., 2012; IFPRI, welt hunger hilfe, concern worldwide). GHI combines three equally weighted indicators: 1. Undernourishment, 2. Child underweight and 3. Child mortality.

be turned into useful “blue water”: i.e. water collected in water bodies and thus made available for irrigation. Equally, increased groundwater availability, besides stimulating plant growth, can be extracted not only for supplementary irrigation of crops but also for domestic use and livestock consumption. As such, water harvesting and productive use of blue water sources, have positive effects on nutrition and poverty through increasing crop production and improving food security. An extra 10 – 25 percent of water runoff harvested and made available during critical periods of plant growth can double or triple yields (Liniger et al., 2011) or simply allow crops to regularly succeed in places with high risk of crop failure (Critchley and Gowing, 2012).

In areas with low and insecure rainfall, irrigation continues to play an important role in increasing crop production and food supply. However, large irrigation schemes have proved to be controversial due to problems of high costs, misman-

agement, damaged ecosystems, limited water resources, salinization, over-abstraction and increasing conflicts over scarce water. Often, a more viable alternative for small-scale production is supplementary irrigation, which complements precipitation during periods of water deficit or stress at sensitive stages of plant growth. There are many technologies that help supply water for supplementary irrigation. These range from dams collecting water for large-scale water supply and irrigation, to farm ponds and shallow wells from which water can be extracted with treadle (or other) pumps for micro-irrigation.

To unlock the potential of small-scale rainfed agriculture, investments in better water management need to be emphasized. In drier areas water harvesting coupled with *in situ* water management as well as improved soil, nutrient and crop management have great potential. In humid areas, *in situ* water management technologies such as conservation agri-



Previous page: (left) Surface runoff, South Africa; (right) stone lines combined with trashlines, Kenya.

left: Drinking water from sand dam. Embu, Kenya.

right: Well in sand dam. Embu, Kenya.

HP. Liniger



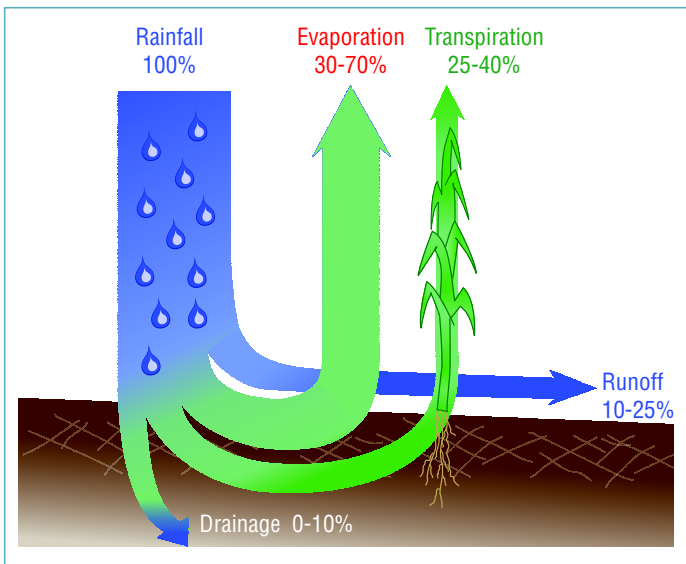

Figure 3: Productive water and losses without water conserving or harvesting measures in drylands. (Liniger et al., 2011 based on Rockström et al., 2007) Note: Water stored in the soil and used directly by plants through transpiration is termed “green water”. Runoff, deep drainage, recharging of groundwater and feeding of streams is called “blue water”.

culture (based on no-till, mulching and crop rotation) are generally more suitable and appropriate (Wani et al., 2009; Liniger et al., 2011; Critchley and Gowing, 2012). These guidelines limit themselves to water harvesting, while being aware that *in situ* systems of water management are equally important, but are relevant to zones with less dry conditions where the priority is to keep rainfall in place, rather than actively attempting to increase its availability through capturing runoff.

### Definition of water harvesting

Water harvesting (WH) has been defined and classified in a number of ways by various authors over the years. The large majority of definitions are closely related, the main difference being how broad the scope is: in other words what is included and what is left out. Annex 1 presents an overview of various definitions of water harvesting. After reviewing these, and in the context of these guidelines, water harvesting is defined as:

*“The collection and management of floodwater or rainwater runoff to increase water availability for domestic and agricultural use as well as ecosystem sustenance”.*<sup>1</sup>

### Aim of water harvesting

The aim of water harvesting is to collect runoff or groundwater from areas of surplus or where it is not used, store it and make it available, where and when there is water shortage. This results in an increase in water availability by either (a) impeding and trapping surface runoff, and (b) maximising water runoff storage or (c) trapping and harvesting sub-surface water (groundwater harvesting, also see Box 6). Water harvesting makes more water available for domestic, livestock and agricultural use (Annex 2) by buffering and bridging drought spells and dry seasons through storage.

### Box 3: A transect of water harvesting through history

Water harvesting has been used in India, the Middle East, the Americas and Africa throughout history, and was the backbone of agriculture especially in arid and semi-arid areas worldwide. Some of the very earliest agriculture, in the Middle East, was based on techniques such as diversion of wadi flow onto agricultural fields. In India, water harvesting is an ancient technique dating back some 4,000 to 5,000 years. In North America the agriculture of many indigenous peoples in what are now the southern states was historically dependent on simple methods of floodwater harvesting.

In the early 20th century, the primary focus of conservation agencies was soil erosion control aimed at reducing soil losses; this progressed to soil and water conservation, based particularly on structural measures (terraces; gabion weirs etc.). The harvesting of runoff that went with some soil conservation measures was more or less a side-effect whose potential was unappreciated. Furthermore, the success of the green revolution, based on hybrid seeds, inorganic fertilizers and pesticides, resulted in a rapid expansion of irrigated areas – and this was seen as the “modern” way forward to improving agricultural water management. However, this expansion soon reached its limits due to over-abstraction, declining water resources and salinization, which led to further impoverishment and in some situations to conflicts. Furthermore the ecological problems associated with dam building became barriers to new construction.

Water scarcity and the widespread droughts in Africa led to a growing awareness of the potential of water harvesting for improved crop production in the 1970s. After a quieter period in the late 1980s, water harvesting again became the subject of study and project implementation at the turn of the century, and indigenous practices regained credence. In China today, water harvesting is seen as a major component in reducing the rural exodus and controlling severe soil erosion and is subject of dedicated projects, aimed at helping millions of people.

Source: Hudson, 1987; Critchley and Siegert, 1991; Prinz, 1996; Falkenmark et al., 2001; Worm and Hattum, 2006; Critchley and Gowing, 2012; Oweis et al., 2012; Scheierling et al., 2013.



Thus water harvesting deliberately reallocates the water resource within a landscape, and over time. Water harvesting captures water for domestic use, or replenishes green water supplies, or increases blue water available locally.

## Principle, concept and components

Water harvesting must be seen as an integral part of sustainable land (and water) management (Box 4).

### Box 4: Sustainable Land Management (SLM): a definition

SLM is the use of land resources, including soils, water, animals and plants, for the production of goods to meet changing human needs, while simultaneously ensuring the long-term productive potential of these resources and ensuring their environmental functions.

Source: Liniger and Critchley, 2007; Liniger et al., 2011.

The basic principle of water harvesting is to capture precipitation falling in one area and transfer it to another, thereby increasing the amount of water available in the latter.

The basic components of a water harvesting system are a catchment or collection area, the runoff conveyance system, a storage component and an application area. In some cases the components are adjacent to each other, in other cases they are connected by a conveyance system (Figure 4). The storage and application areas may also be the same, typically where water is concentrated in the soil for direct use by plants.

- **Catchment or collection area:** this is where rain in the form of runoff is harvested. The catchment may be as small as a few square meters or as large as several square kilometres. It may be a rooftop, a paved road, compacted surfaces, rocky areas or open rangelands, cultivated or uncultivated land and natural slopes.
- **Conveyance system:** this is where runoff is conveyed through gutters, pipes (in case of rooftop WH) or overland, rill, gully or channel flow and either diverted onto cultivated fields (where water is stored in the soil) or into specifically designed storage facilities.
- **Storage component:** this is where harvested runoff water is stored until it is used by people, animals or plants. Water may be stored in the soil profile as soil

moisture, or above ground (jars, ponds or reservoirs), or underground (cisterns) or as groundwater (near-surface aquifers) (Oweis et al., 2012). There, where concentrated runoff is directly diverted to fields, the application area is identical to the storage area, as plants can directly use the accumulated soil water. A great variety of designed storage systems keep the water until it is used either adjacent to the storage facilities or further away.

- **Application area or target:** this is where the harvested water is put into use either for domestic consumption (drinking and other household uses), for livestock consumption, or agricultural use (including supplementary irrigation).

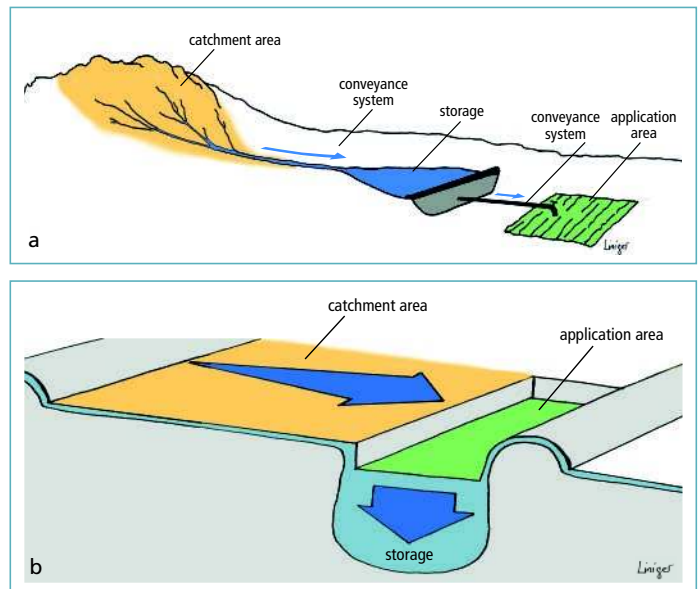

Figure 4: Basic components of two WH systems: a) catchment area, storage and application area are clearly separated and connected by conveyance systems; b) catchment area is bordering application area. Storage is in the soil or ground below the application area with no need for extra conveyance systems.

Water harvesting may occur naturally, for example in depressions, or “artificially” through human intervention. Artificial WH often involves interventions to improve precipitation collection and to direct runoff to the application area. Runoff for WH is encouraged and, when it is very low, it can be induced by, for example, smoothing or compacting the soil surface, clearing rock surfaces, surface sealing or using impermeable coverings.



<sup>1</sup> Water availability includes the recharge of soil water and groundwater and water stored in reservoirs. Water harvesting for ecosystem sustenance as well as for industrial use are recent applications of water harvesting: though the bulk of water harvesting technologies that have been developed throughout history serve for domestic and agricultural use.

Commonly the terms water harvesting (WH) and rainwater harvesting (RWH) are used interchangeably. But water harvesting is most generally used as the umbrella term for a range of methods of collecting and managing floodwaters and runoff including rooftop WH, runoff irrigation, spate irrigation and runoff farming (Critchley and Siegert, 1991; Falkenmark et al., 2001; Critchley and Gowing, 2012; Oweis, Prinz and Hachum, 2012; Scheierling et al., 2013).

left: Semi-circular bunds, Niger.

centre: Stone lines on grazing land, Niger.

right: Rock catchment, Mukogodo, Kenya.

### Box 5: The 3R concept in a nutshell

This approach focuses on water buffering in order to better manage natural recharge, and to extend the chain of water use. When water is abundant, a large portion is commonly lost: unused: through floods, surface runoff and evaporation. Through buffering techniques this unused water can be retained as indicated in the figure below. Four main categories, or strategies, of buffering can be distinguished:

- Groundwater recharge and storage. This is “closed” storage hence evaporation losses are smaller than under open water storage. Water is not directly available as wells are necessary to access it from the ground. Examples include sand dams, infiltration ponds, and spate irrigation.
- Soil moisture conservation in the root zone. This storage option is relatively closed as water is stored in the upper part of the soil: the root zone. Part of the water can be used by crops though part percolates deeper to recharge the groundwater. Examples include grass strips, deep ploughing, and conservation agriculture.
- Closed tank storage. This provides a method to store water in a clean manner, close to the location where it is used as drinking water. Examples include rooftop tanks, underground cisterns and fog shields.
- Open surface water storage. This provides a method to store larger volumes and can be used for agricultural and industrial purposes. Examples include small storage reservoirs, road water harvesting, and trapezoidal bunds.

Each type of buffer option has its own strength and weakness, and local conditions usually help define which to use. In general, the buffering capacity increases as one moves from small to large storage, and from surface to soil or groundwater storage. Often different types of storage complement each other in water buffering at landscape and basin level.

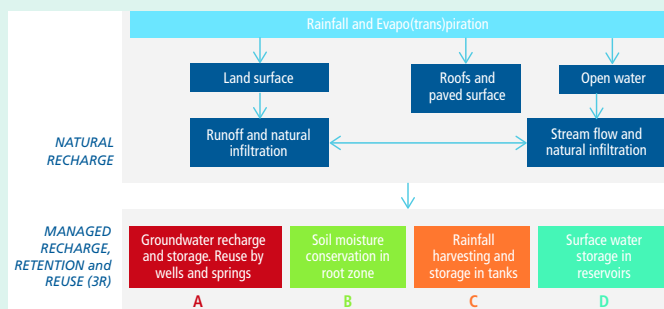

Source: Van Steenbergen and Tuinhof, 2009; Tuinhof et al., 2012, www.bebuffered.com.

The catchment to application area ratio (C:A) represents the degree of concentration of rainfall / runoff in water harvesting systems, and it compares the size of the catchment with that of the application area. It is generally used where runoff is stored in the soil for plant production. In the design of WH systems this ratio is determined by considering seasonal rainfall, crop water requirement, and physical characteristics of both the catchment and the concentration area. Ideally the catchment area (with the exception of rooftop water harvesting) requires clay or shallow soils with low infiltration rates, those susceptible to sealing and crusting, or hard surfaces with high runoff coefficients such as roads or rocky hillsides. In contrast, deep soils with high water infiltration and storage capacity are desirable in the application area in those systems where runoff is stored in the soil for use by plants.

Water harvesting – together with *in situ* water conservation: can also be conceptualised within the “3R” approach (Van Steenbergen and Tuinhof, 2009). In this context the 3Rs are “Retention, Recharge and Reuse” of water resources. The 3R approach is explained in Box 5. In brief, it is based around “water buffering” where the focus is on strengthening natural processes of storing excess water, above and below ground, for later productive use and for environmental benefits.

### Water harvesting as part of integrated water resource management

End users manage water according to different strategies and principles, depending on the amount of rainfall, potential evapotranspiration and the cropping system (or other use of water). Four different water management strategies (based on Hudson, 1987) can be recognised:

- Management of excess water from rainfall or seasonal flooding through controlled drainage and water storage for future use. Most suitable in humid and sub-humid conditions as well as semi-arid and arid conditions (floodwater harvesting).
- Increasing rainwater capture and availability, making use of surface runoff; suitable for dry sub-humid to arid conditions (rainwater harvesting).
- Reducing *in situ* water loss: improving direct water infiltration and reducing evaporation; soil water conservation practices that prevent surface runoff and keep rainwater in place (e.g. conservation agriculture, level bench terraces, mulching, dew harvesting); suitable for sub-humid to semi-arid conditions (*in situ* water conservation).
- Increasing water use efficiency (e.g. good agronomic practice, including use of best-suited planting material and fertility management).



K. Wohlmann

In order to improve productivity in the most sustainable way a combination of strategies to ensure these functions is often required.

Water management is the overarching term that covers all practices improving water availability. Figure 5 shows different agricultural water management practices within the range from purely rainfed to fully irrigated production systems.

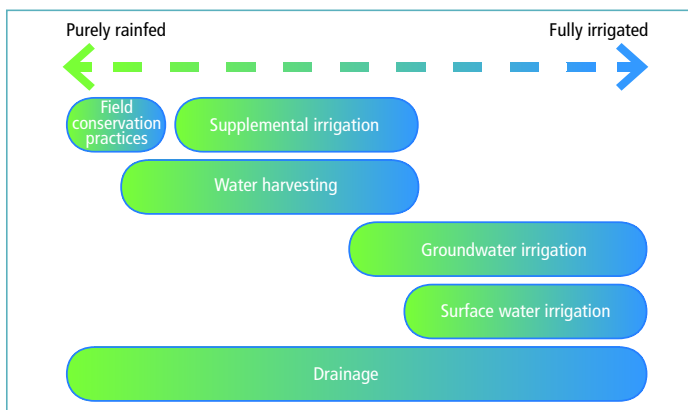

Figure 5: Spectrum of agricultural water management (Molden, 2007). Field conservation practices relate to in situ water conservation practices.

## Classification and categorisation

The two most frequently used criteria to classify water harvesting systems are the catchment type and size, and the method of water storage.<sup>2</sup>

The classification of water harvesting based on catchment type is selected as the basis for these guidelines and thus for the structure of Part 2. Hence, four groups are distinguished: Floodwater harvesting, macrocatchment systems, microcatchment systems, and rooftop / courtyard water harvesting.

This categorisation considers the size of catchment and takes account of storage methods and end use. It integrates the classifications used by Critchley and Siegert (1991), Oweis et al. (2012) and Tuinhof et al. (2012).

Tables 1 and 2 bring together the four water harvesting groups based on catchment type.

### Box 6: Groundwater harvesting

Another WH group based on catchment type put forward by a number of authors is "groundwater harvesting" where harvested floodwater and surface runoff can recharge and replenish groundwater. This is conserved and stored to be re-used for extending growing periods and/or for supplementary irrigation during dry periods. Groundwater harvesting covers traditional as well as unconventional ways of groundwater extraction (e.g. Qanat systems, horizontal wells, etc.).

Source: Critchley and Siegert, 1991; Prinz and Singh, 2000; Van Steenberg and Tuinhof, 2009.



<sup>2</sup> Water harvesting technologies can be classified, or categorised into groups, in various ways depending on what aspect/ criteria of water harvesting is emphasised: these include agro-climatic zone, hydro-climatic hazards (e.g. Falkenmark et al., 2001), spatial scale of runoff collection, size (e.g. Botha et al., 2011; Oweis et al., 2012), catchment type (e.g. Critchley and Siegert, 1991; FAO, 1994 and 2001), storage systems and strategies (e.g. Van Steenberg and Tuinhof, 2009; Tuinhof et al., 2012), geographical area, topography (e.g. African Development Bank, 2009), source of water collected (e.g. Fox, 2001 cited in Falkenmark et al., 2001), water use (e.g. Oduor and Gadain, 2007; Faurès and Santini, 2008), or by origin (e.g. Barry et al., 2008).

left: Spreading weir, West Africa.

right: Spreading weir, Chad.

**Table 1: Classification of water harvesting based on catchment type**

	Water Harvesting			
	Floodwater	Rainwater runoff		
Group	(1) Floodwater harvesting (FloodWH)	(2) Macrocatchment WH (MacroWH)	(3) Microcatchment WH (MicroWH)	(4) Rooftop & Courtyard WH (Rooftop-CourtyardWH)
Strategy	Capture excess water from outside farm or field and spread floodwater	Trap runoff from outside farm or field	Trap localised runoff within field	Trap runoff from settlements
Agroclimatic zone	Dry sub-humid, semi-arid and arid climates; Dry areas with ephemeral watercourses and few heavy events	Dry sub-humid, semi-arid and arid climates; Where few runoff events expected per rainy season	Dry sub-humid and semi-arid climates; Where rainfall is more reliable but scattered and/or poorly distributed within the season	All climates; With dry spells and where rainfall is seasonal
Catchment	External: Large catchments or watersheds; Distinction between hilly catchment zone and cultivated fields in plain; One system with one catchment area	External: Small catchments or watersheds; Catchment and application area clearly separate; One system with one catchment area	In-field;  Catchment and application area distributed evenly over field; System replicated many times with identical designs	Household / settlement;  One system with one catchment
Runoff water	Channel flow with more or less well-defined course	Sheet and rill flow (turbulent overland runoff), short channel flow	Sheet and some rill flow	Sheet flow from rooftops and sealed surfaces
Storage	Soil moisture in root zone; Groundwater recharge	Soil moisture in root zone; Groundwater recharge; Reservoirs: dams and ponds; Tanks (surface and subsurface)	Soil moisture in root zone; Pits, trenches and bunds for planting	Tanks (surface and subsurface)
Use of water	Crop production: Supplementary irrigation, high groundwater recharge, improve soil moisture	Multiple use: domestic use, water for livestock, crop production: improve soil moisture, groundwater recharge and water storage for supplementary irrigation	Crop, fodder and tree production: improve soil moisture, limited groundwater recharge	Multiple use: domestic use, water for livestock, small-scale crop and horticultural tree production: water storage for supplementary irrigation of kitchen gardens / backyard crops; agro-processing no groundwater recharge
Management	Large communities or local authority, integrated watershed management	Community or individual	Individual or community	Individual or community
Examples of main networks and actors*	The Spate Irrigation network ( <a href="http://www.spate-irrigation.org">www.spate-irrigation.org</a> ); MetaMeta Research ( <a href="http://www.metameta.nl">www.metameta.nl</a> )	Rainwater Harvesting Implementation Network (RAIN). <a href="http://www.rainfoundation.org">www.rainfoundation.org</a> Southern and Eastern Africa Rainwater Network (SearNet) ( <a href="http://worldagroforestry.org/projects/searnet/">http://worldagroforestry.org/projects/searnet/</a> ) ASAL Consultants Ltd, Erik Nissen-Petersen. ( <a href="http://www.waterforaridland.com">www.waterforaridland.com</a> ); Excellent. Pioneers of Sand Dams. ( <a href="http://www.excellentdevelopment.com">www.excellentdevelopment.com</a> )	International Rainwater Harvesting Alliance (IRHA) ( <a href="http://www.irha-h2o.org">www.irha-h2o.org</a> ); World Overview of Conservation Approaches and Technologies ( <a href="http://www.wocat.net">www.wocat.net</a> ); Centre for Science and Environment (CSE) ( <a href="http://www.rainwaterharvesting.org">www.rainwaterharvesting.org</a> )	Rainwater Harvesting Implementation Network (RAIN). <a href="http://www.rainfoundation.org">www.rainfoundation.org</a> Greater Horn of Africa Rainwater Partnership (GHARP). <a href="http://www.gharain-water.org">http://www.gharain-water.org</a> Rural Water Supply Network (RWSN). ( <a href="http://www.rural-water-supply.net">www.rural-water-supply.net</a> )
Examples recurrent events*	Annual Short Course on Spate Irrigation at UNESCO-IHE	International Conference on Sustainable Water Resources Management; International Water Association (IWA) Specialist Group Conference on Ponds Technology World Water Forum	SearNet International Conference	World Water Summit; Symposium International Water and Sanitation Centre (IRC)

\* for more information on networks, actors and recurrent events refer to Annex 4.

**Table 2: Major technologies under each water harvesting group**

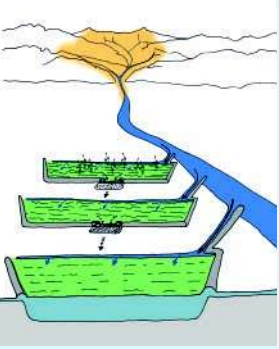
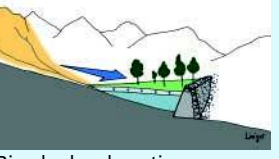
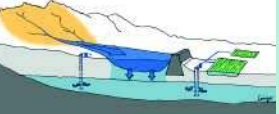
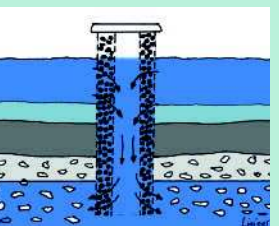
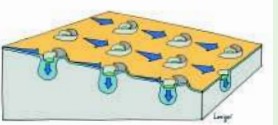
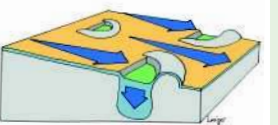
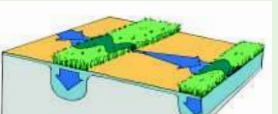
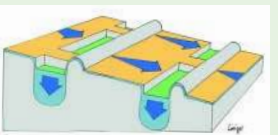
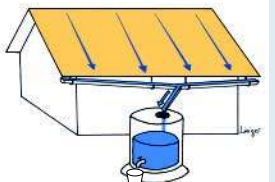
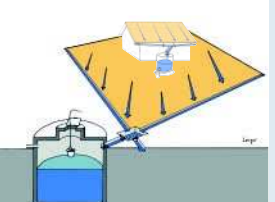
Technologies by group*	(1) Floodwater harvesting (FloodWH)	(2) Macrocatchment WH (MacroWH)	(3) Microcatchment WH (MicroWH)	(4) Rooftop and Courtyard WH (Rooftop-Courtyard WH)
	<p><b>Flood recession farming;</b>  <b>Inland valleys;</b>  <b>Floodwater diversion, off-streambed:</b>                      – spate irrigation,                      – floodwater spreading bunds;</p>  <p>Spate irrigation</p> <p><b>Floodwater harvesting within stream bed:</b>                      – riverbed / wadi and gully reclamation: e.g. <i>jessour</i>, <i>tabias</i>, "warping" dams,                      – permeable rock dams</p>  <p>Riverbed reclamation</p>	<p><b>Water storage in soil:</b>                      – hillside runoff / conduit,                      – foothill reclamation: e.g. <i>limans</i>,                      – large semi-circular or trapezoidal bunds,                      – road runoff,                      – gully plugging / productive gullies,                      – cut-off drains (redirection of water);</p> <p><b>Water storage facilities:</b>  <b>Surface storage:</b>                      – natural depressions,                      – ponds and pans,                      – excavated ponds (e.g. <i>hafirs</i>),                      – cultivated reservoirs / tanks,                      – ponds for groundwater recharge,                      – surface dams: small earth and stone dams, check dams, rock catchment masonry dams;</p> <p><b>Subsurface storage:</b>                      – subsurface, percolation and sand dams,                      – subsurface reservoirs: cisterns;</p>  <p>Macrocatchment systems</p> <p><b>Traditional wells:</b>                      – horizontal wells,                      – recharge / injection wells.</p>  <p>Recharge / injection well</p>	<p><b>Pits and basins:</b>                      – small planting pits: e.g. <i>zai / tassa</i>,                      – micro-basins: e.g. <i>negarims</i>, <i>meskats</i>, small semi-circular bunds, eyebrow terraces, mechanised Vallerani basins;</p>  <p>Planting pits</p>  <p>Semi-circular bunds</p> <p><b>Cross-slope barriers:</b>                      – vegetative strips,                      – contour bunds and ridges,                      – tied ridges,                      – stone lines and bunds,                      – contour bench terraces (e.g. <i>fanya juu</i>),</p>  <p>Vegetative strips</p>  <p>Contour lines and trenches</p>	<p><b>Catchment:</b>  <b>Roofs</b>  <b>Courtyards:</b>                      – including surfaces of rock, compacted earth, sealed or paved surfaces,                      – plastic sheets, corrugated iron sheeting;</p> <p><b>Storage:</b>                      – tanks,                      – reservoirs,                      – cisterns.</p>  <p>Rooftop WH</p>  <p>Courtyard WH combined with rooftop WH</p>
<p><b>Examples of manuals**</b></p>	<p>Engineering Manual for Spate Irrigation (Ratsey, 2011);                      Guidelines for Spate Irrigation (Van Steenberg et al., 2010).</p>	<p>Les petits barrages de décrue en Mauritanie (Durand, 2012);                      A practical guide to sand dam implementation (RAIN, 2009);                      Water from small earth dams (Nissen-Petersen, 2006;  <a href="http://www.waterforaridland.com/publications.asp">www.waterforaridland.com/publications.asp</a>).</p>	<p>Le Sahel en lutte contre la désertification (Rochette, 1989);                      Water Harvesting. A Manual for the Design and Construction of Water Harvesting Schemes for Plant Production (Critchley and Siegert, 1991);                      Water Harvesting: An Illustrative Manual for Development of Microcatchment Techniques for Crop Production in Dry Areas (Hai, 1998).</p>	<p>Water from roofs (Nissen-Petersen, 2007);                      Roofwater Harvesting: a Handbook for Practitioners (Thomas and Martinson, 2007)</p>

\* for all figures: yellow indicates catchment area, blue storage and conveyance and green application area (target).

\*\* for detailed information and more references refer to Annex 5.

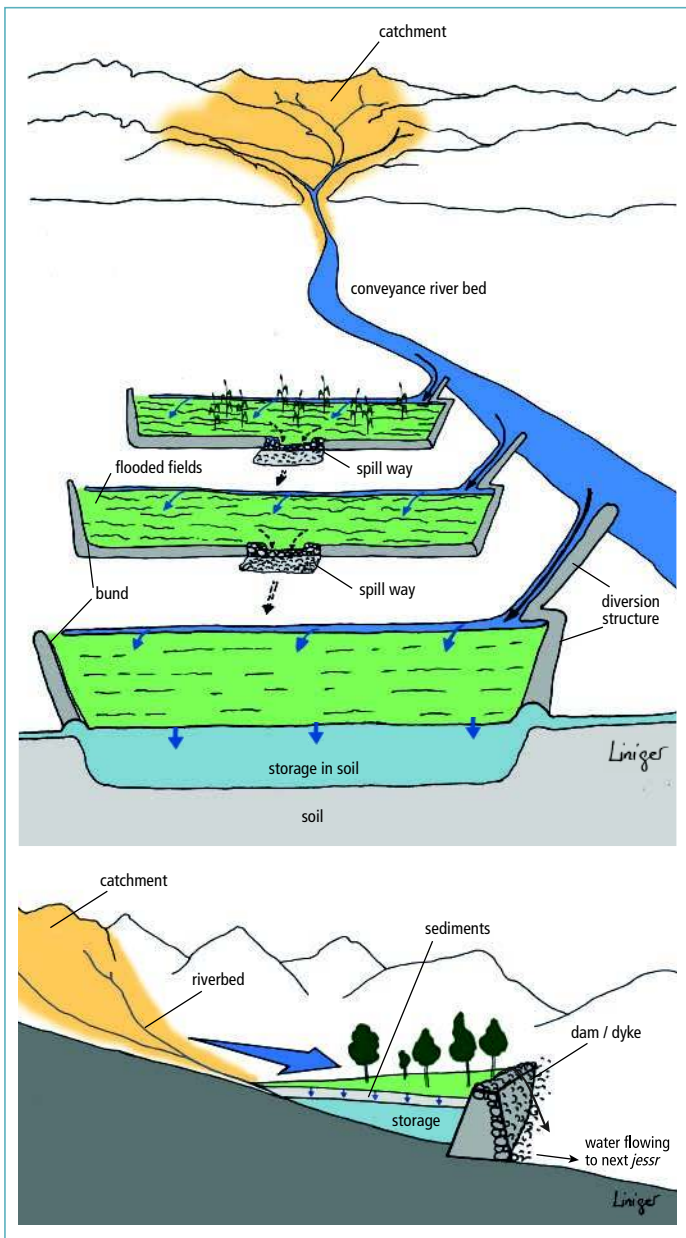

Figure 6: Floodwater harvesting; above: floodwater diversion system (off-streambed); below: floodwater harvesting within streambed, a cross-section of a jessour system. (jessr=singular).

According to the proposed classification system the allocation of WH practices to the four groups is basically straightforward except for FloodWH and MacroWH. Several technologies can

be assigned to either: depending on the size. For example, larger systems of gully rehabilitation, road runoff, spreading weirs and sand, subsurface and percolation dams could be declared as FloodWH, whereas smaller systems of the same technologies could be classified under MacroWH. Furthermore similar technologies can have different names (local names) in different regions e.g. *tassa* and *zai*; *limans* and *tabias*.

The characteristics of the four selected groups presented in Table 1 and 2 are explained more in the following section and in Part 2 of these guidelines.

### Floodwater harvesting

Floodwater harvesting (FloodWH, Group 1) can be defined as the collection and storage of ephemeral channel flow for irrigation of crops, fodder and trees, and for groundwater recharge. The catchment area may be several kilometres long. In areas where evaporation exceeds rainfall, floodwater harvesting systems (Figure 6) provide an option for the optimal use of water during flood events.

Floodwater harvesting can be further classified into:

- **Floodwater diversion / off-streambed system**, the channel water either floods over the river / channel bank onto adjacent plains (wild flooding) or is forced to leave its natural course and conveyed to nearby fields. Spate irrigation is an alternative name, often applied to ancient systems of floodwater diversion.
- **Floodwater harvesting within streambed**, the water flow is dammed and as a result, is ponded within the streambed. The water is forced to infiltrate and the accumulated soil water is used for agriculture.

#### Main characteristics

- temporary channel flow harvested either (a) using natural flooding or diverting spate flow from rivers and large gullies; or (b) impounding water within channel bed / valley floor;
- stabilization of river bed to avoid scour;
- spur diversions, channelling of water or cross riverbed dams (often breachable) in seasonal stream or river; dam materials are earth, stone, brushwood or reinforced material (gabions, rock masonry, concrete) or combinations; runoff stored in soil over whole planted area;
- large distant catchment (may be several kilometres);
- size 2 to: 50 km<sup>2</sup>;
- catchment: application area ratio 100:1 – 10,000:1;
- defined water usage rules;

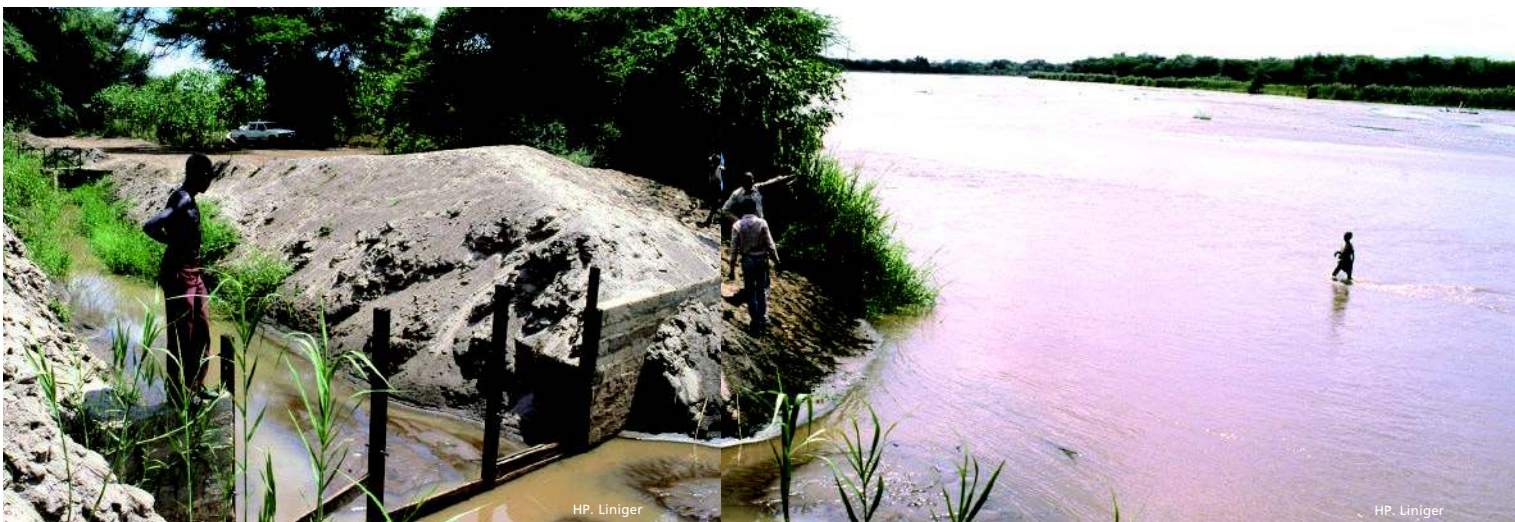

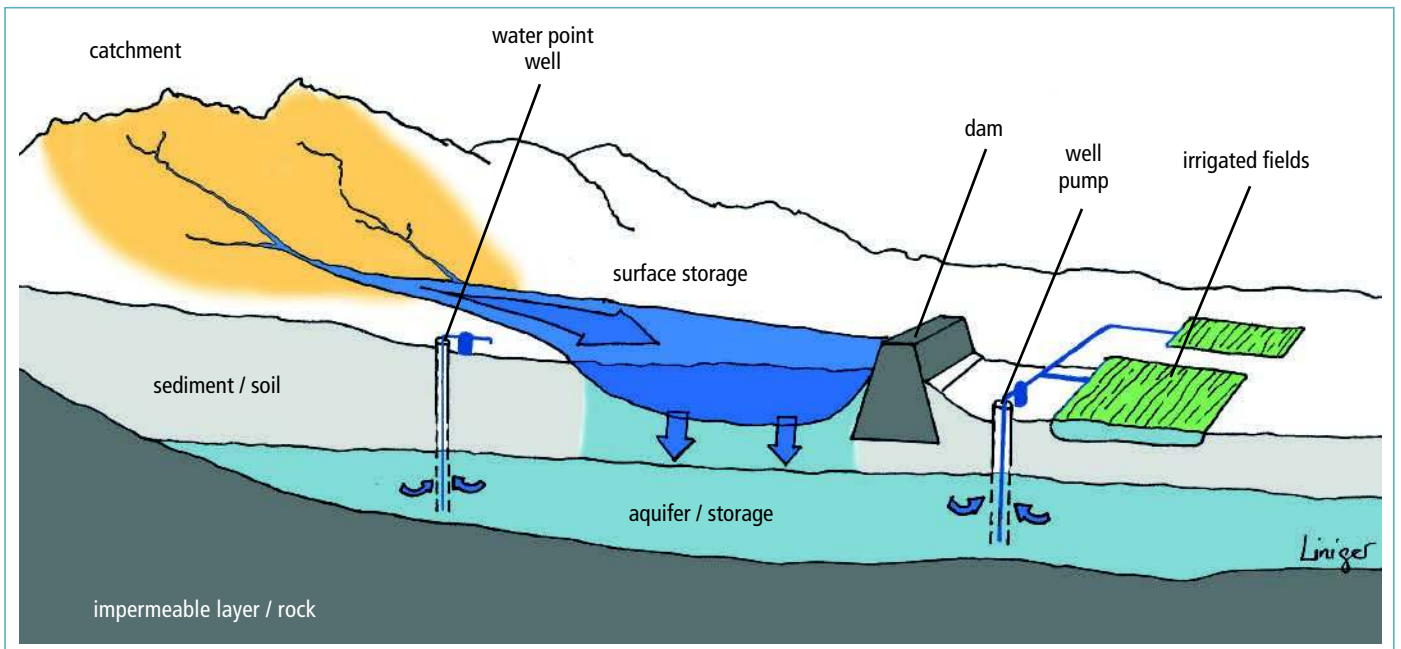

Figure 7: Macrocatchment water harvesting: a cross-section.

- provision for overflow of excess water: through central spillway or two lateral spillways or by capacity to breach (e.g. temporary earth structures);
- (traditional) engineering skills needed;
- in combination with groundwater recharge and subsequent use leading to highly productive systems;
- often 'self-fertilizing' through sediment build-up;
- no control over catchment area because located outside farm boundaries.

Based on: Critchley and Siegert, 1991; African Development Bank, 2009; Van Steenberg et al., 2010; Liniger et al., 2011; Critchley and Gowing, 2012; Oweis et al., 2012.

### Macrocatchment water harvesting

Macrocatchment WH (MacroWH, Group 2) is a method of harvesting runoff water from a natural catchment such as the slope of a mountain or hill (Figure 7). It may be:

- runoff collection from shallow soils or sealed and compacted surfaces;
- direct diversion and spreading of overland surface water flow onto application area at the foot of hills or flat terrain (mainly cultivated areas) or
- impeding and collecting runoff through barriers and storage facilities.

The harvested water is mainly used for crop and livestock production but also for domestic use, depending on the quantity and quality.

### Main characteristics

- overland flow or rill flow harvested;
- diverted from hillsides, pasture land, forests or roads and settlements;
- runoff usually stored in the soil or in storage facilities;
- catchment usually 30: 200 metres in length;
- size of catchment from 0.1: 200 ha;
- catchment: application area ratio 10:1 100:1;
- runoff coefficient relatively low: 0.1 to 0.5 (10 – 50% of annual rainfall); the longer the catchment the lower the coefficient;
- provision for overflow of excess water;
- cropping area terraced on slopes or in flat terrain;
- suitable for annual and perennial crops tolerant of temporary waterlogging or rapidly maturing on residual moisture;
- nutrients harvested from accumulated sediments and washed-in animal droppings;
- no control over catchment area because located outside farm boundaries.

Based on: Critchley and Siegert, 1991; African Development Bank, 2009; Liniger et al., 2011; Critchley and Gowing, 2012; Oweis, et al., 2012.



left and centre: Floodwater intake, gate and irrigation canal, Turkana, Kenya.

right: Warping dam, Rajasthan, India.



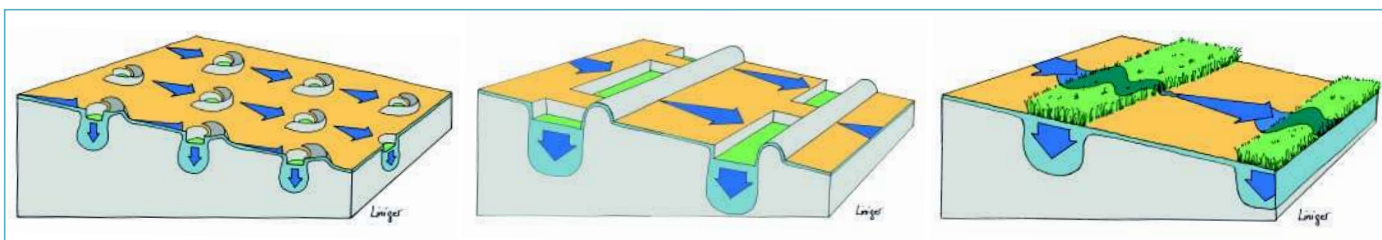

Figure 8: Microcatchment water harvesting: (left) planting pits e.g. chololo, zai, tassa; (centre) contour bunds with trenches e.g. tied fanja chini; (right) vegetative barriers e.g. grass strips. Yellow: indicates bare or compacted catchment area; light blue: storage of water in soil; green: application area with crops, trees, etc.; dark blue arrows: indicate direction of water flow.

### Microcatchment water harvesting

Microcatchment WH (MicroWH, Group 3) is a method of collecting surface runoff/ sheet (and sometimes rill flow) from small catchments of short length (Figure 8). Runoff water is concentrated in an adjacent application area and stored in the root zone for direct use by plants. Catchment and application areas alternate within the same field, thus rainwater is concentrated within a confined area where plants are grown. Hence, the system is replicated many times in an identical pattern. Microcatchment WH technologies are often combined with specific agronomic measures for annual crops or tree establishment, especially fertility management and pest management.

#### Main characteristics

- sheet and rill flow harvested from short catchment length;
- runoff stored in soil within field;
- catchment length usually between 1 and 30 metres;
- size of individual catchment 10 to 1000 m<sup>2</sup>;
- catchment: storage area ratio 1:1: 10:1;
- relatively high runoff coefficients, higher than macro-catchment systems;
- catchment area generally bare with sealed, crusted and compacted soils;
- system replicated many times with identical design within the same field;
- no water conveyance system needed;
- no provision for overflow;
- easily replicable and adaptable;
- suitable for most crops, planted in pits or strips within field;
- needs fertility management;
- land user has control within his farm over catchment and the application area.

Based on: Critchley and Siegert, 1991; African Development Bank, 2009; Liniger et al., 2011; Critchley and Gowing, 2012; Oweis et al., 2012.

### Rooftop and courtyard water harvesting

Rooftop and Courtyard WH (Rooftop-CourtyardWH, Group 4) are getting more and more popular in both developed and emerging economy countries (e.g. Australia, the Caribbean, China, India, and the South-Pacific) to secure / improve water supply for domestic use such as sanitation or garden irrigation (Figure 9).

- **Rooftop WH:** Harvesting of rainwater can be from roofs of private, public or commercial buildings (e.g. greenhouses, schools). The effective area of the roof and local annual rainfall will determine the volume of the rainwater that can be captured. Between 80 – 85 percent of rainfall can be collected and stored (Oweis et al., 2012). Rainfall collected from roofs is used for drinking; especially in areas where tap water is unavailable or unreliable (Worm and van Hattum, 2006). These systems are used in most tropical and sub-tropical countries.
- **Courtyard WH:** Rainwater is collected from compacted, paved surfaces or where plastic sheeting has been laid out. The slope and permeability affects the amount of rainwater that can be collected. The water may be stored above or below ground.

#### Main characteristics

##### Rooftop WH

- consists of roof, gutters, 'first flush' device and above or below ground storage tank;
- useful in areas with rainfall between 200 and 1000 mm. Especially good in areas with two separate rainy seasons (bimodal);
- high runoff coefficient (0.5 to 0.9);
- mainly used for domestic purposes;
- may recharge groundwater if an infiltration well is built;



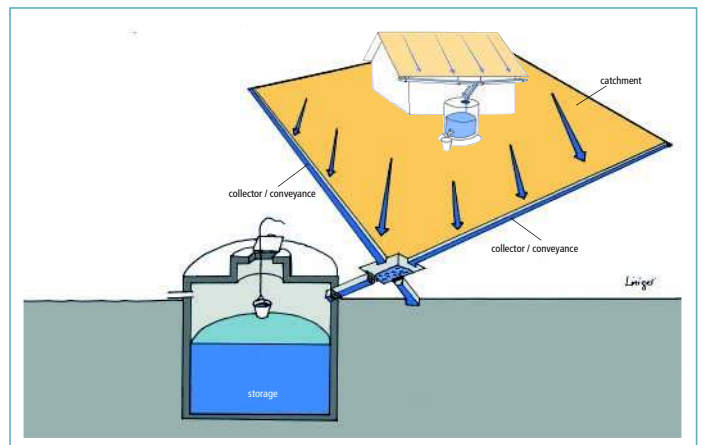
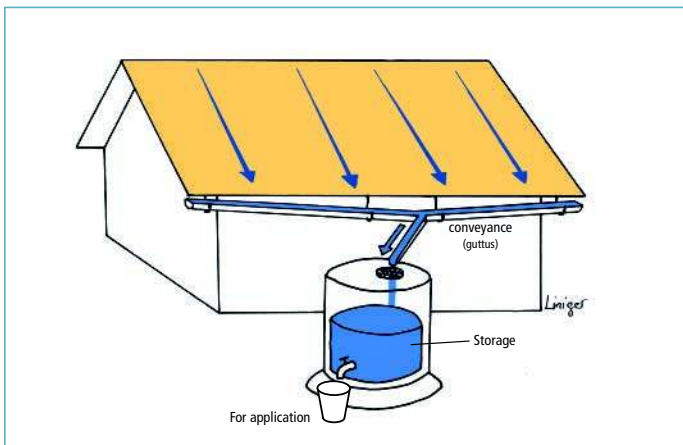

Figure 9: (left) water harvested from roofs used for drinking, domestic purposes and irrigation of kitchen gardens; (right) rooftop and courtyard water harvesting for irrigation of kitchen gardens and domestic use.

- quality of water can be controlled by flushing away the first collection (from a dirty roof) filtration and simple disinfection techniques;
- collected water is normally acceptable both in terms of taste and appearance;
- provides water next to homes;
- the user has control.

#### Courtyard WH

- consist of catchment area, retention and conveyance structures and above or below ground storage tanks;
- useful in arid and semi-arid region (rainfall between 200 and 750 mm) – even semi-desert (< 200 mm);
- for domestic use and livestock consumption mainly;
- quality of water can be controlled by flushing away the first collection (from a dirty roof) filtration and simple disinfection techniques;
- provides water next to homes;
- the user has control.

Based on: African Development Bank, 2009; Oweis et al., 2012.

In the second part of these guidelines, all the relevant water harvesting technologies are described under the four groups as introduced above, namely:

1. Floodwater harvesting
2. Macrocatchment water harvesting
3. Microcatchment water harvesting
4. Rooftop and Courtyard water harvesting

Groundwater harvesting is integrated into the macrocatchment WH group, even though some of the systems and technologies to replenish groundwater could also be classified under floodwater harvesting.

### Benefits and constraints: the pros and cons of water harvesting

The applicability and impact of water harvesting technologies depend on local conditions. There are specific “pros” and “cons” associated with water harvesting (Table 3). On the “pro” side, improving the efficiency with which rainfall is used reduces pressure on traditional water resources and hence on water itself. It can meet water needs for domestic uses and animal production where public supplies are not available (Oweis et al., 2102). Water harvesting offers a cheaper alternative to expensive water schemes in areas with low-input agriculture, particularly if the technology implemented builds on traditional practices. These are the direct benefits of WH; however there are also hidden indirect benefits such as environmental protection and socio-economic advantages which are less obvious and more difficult to quantify. For example when water harvesting is used to improve domestic water supplies: helping to make clean drinking water available throughout the year – this can reduce the burden of women and children who in many parts of the world have the responsibility of fetching water.



left: Planting pits for afforestation, Loess Plateau, China.

right: Microcatchment with cemented surface, Loess Plateau, China.

**Table 3**

**Benefits and constraints of water harvesting**

Benefits	Constraints
<ul style="list-style-type: none"> <li>• Securing water and productivity in dryland areas</li> <li>• Increasing water availability</li> <li>• Buffering rainfall variability</li> <li>• Overcoming dry spells</li> <li>• Harvesting plant nutrients</li> <li>• Helping to cope with extreme events (flooding, soil erosion, siltation etc.)</li> <li>• Providing an alternative to full irrigation</li> <li>• Offering flexibility and adaptability to suit circumstances / context and to fit budget</li> <li>• Reducing production risks, thus reducing vulnerability</li> <li>• Increasing resilience of systems</li> <li>• Improving access to clean and safe domestic water</li> <li>• Improving water availability for livestock</li> <li>• Reducing women’s work load</li> <li>• Increasing food production and security</li> <li>• Offering the possibility of growing higher-value crops</li> <li>• Utilizing and improving local skills</li> <li>• Alleviating poverty: when adopted at scale</li> <li>• Reducing migration to the cities</li> </ul>	<ul style="list-style-type: none"> <li>• Dependent on the amount, seasonal distribution and variability of rainfall</li> <li>• Difficult to ensure sufficient quantity of water needed</li> <li>• Supply can be limited by storage capacity, design and costs</li> <li>• Structures / microcatchments may take up productive land</li> <li>• Pounded water can be breeding ground for mosquitos or source of waterbourne diseases</li> <li>• May involve high initial investments and/or labour requirements for maintenance</li> <li>• Jointly used structures can lead to maintenance disagreements</li> <li>• Shared catchments and infrastructure may create rights issues (upstream-downstream, farmers and herders)</li> <li>• Acceptance of new systems and associated rules and regulation may be a problem</li> <li>• Maintenance of communal infrastructure: built with subsidies: can be a constraint</li> <li>• Long-term institutional support may be necessary</li> <li>• May deprive downstream ecosystems of water (esp. where floodwater is diverted)</li> </ul>

Source: Prinz,1996; Falkenmark et al., 2001; Liniger and Critchley, 2007; Rockström et al., 2007; Anderson and Burton, 2009; Liniger et al., 2011; Critchley and Gowing, 2012; Oweis et al., 2012; Scheierling et al., 2013.

**Box 7: Benefits of water harvesting**

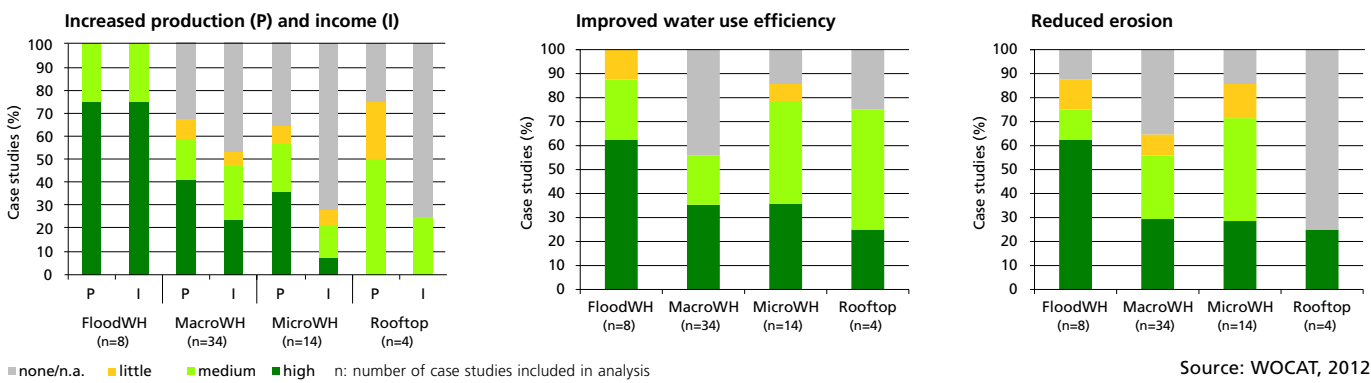

Source: WOCAT, 2012

Left: Production and income: Floodwater harvesting shows a clear increase in yield and income, whereas in the other two groups an improvement is not always recognised. Floodwater is mostly related to annual crop production on larger areas. Macro- and microcatchment also include perennial crops and trees for environmental protection which take longer to show production benefits and higher income. Some of the macrocatchments mainly provide water for domestic use.

Centre: Water use efficiency: As expected all WH groups indicate improved water use efficiency, mostly high to medium. This relates to reduced evaporation loss and improved soil water availability. Some indicate little to no improvement.

Right: Erosion control: Apart from RooftopWH all other groups show medium to high erosion control. Best rated are FloodWH and MicroWH, whereas in the group of MacroWH erosion control is still a challenge with respect to surface dams due to management constraints of the catchment area.



## Box 8: Benefit to cost

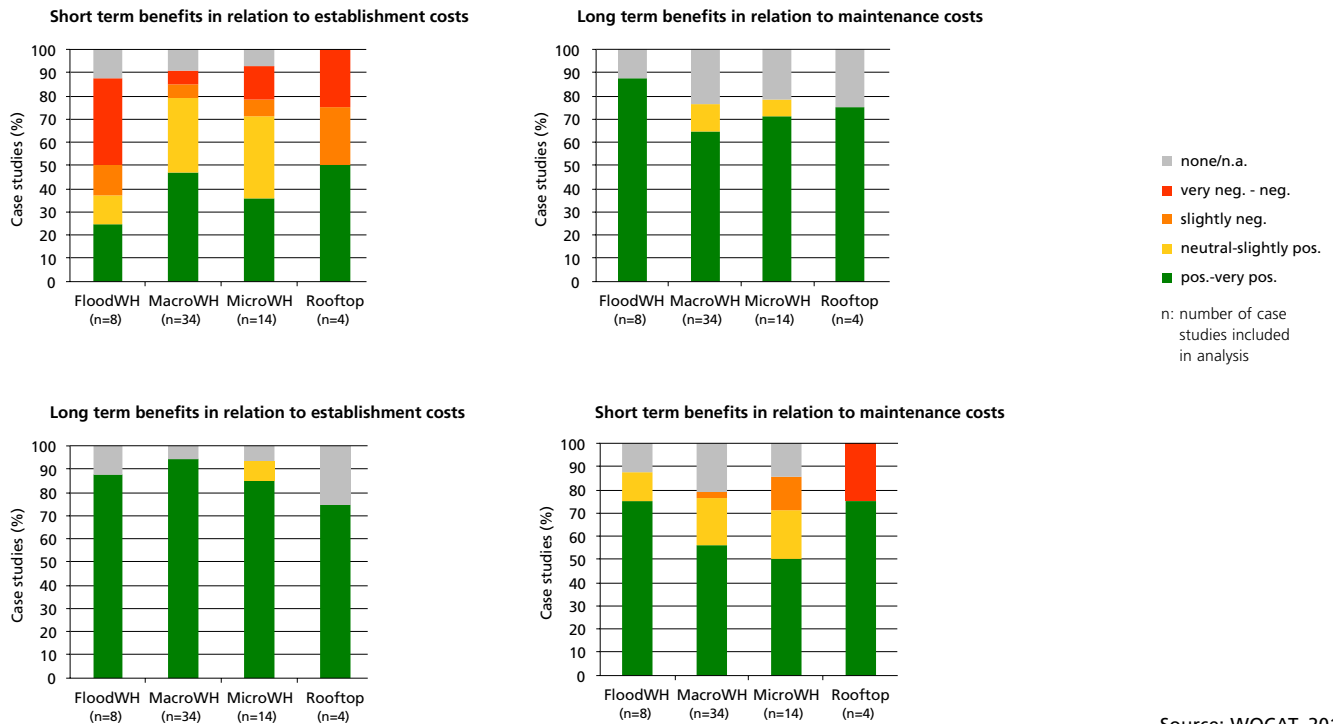

Source: WOCAT, 2012

In the short-term, costs can be higher than the benefits even though in more than one third of the cases benefits are already perceived to be positive to very positive in the first years. In the long-term, the benefits strongly outweigh the establishment and maintenance costs. Macrocatchments may require higher establishment and also maintenance costs, due to more demanding engineering structures.

Water harvesting technologies also come with uncertainties and risks; the first is their dependence on variable rainfall. In developing regions, the prevailing climatic conditions include strong seasonality and erratic rainfall. While water harvesting can help manage these, where they are extreme they can make specific technologies less effective or even lead to increased soil erosion if structures breach. Water harvesting structures may take land out of productive use, though this in fact may be an illusion as in many cases there may be no productivity without a catchment and the runoff this provides. Water harvesting can lead to loss of habitat of flora and fauna due to clearance of slopes, or where harvested water fills up depressions (Oweis, et al., 2012).

The risks and uncertainties of climatic conditions in dryland areas, however, should be taken as a challenge to design systems that are better adapted to local circumstances: in many regions there are simply no alternatives to water harvesting. The main benefits and constraints are summed up in Table 3 and Annex 3.

### What works where and when

Table 4 summarises which WH groups are suitable under what conditions and where there are limitations.



left and centre: Kanda rock catchment, Afghanistan.  
 right: Vallerani microcatchments, Syria.

**Table 4**

**Suitability and constraints of water harvesting**

Applicability*	Water harvesting group			
	Floodwater harvesting	Macrocatchment WH	Microcatchment WH	Rooftop & Courtyard WH
Annual rainfall range**	100 – 700 mm extreme runoff events, episodic floods; periodic crop water deficits	200 mm – 1,500 mm major and intense runoff events, infrequent; dry spells, water deficit during critical growth phase	200 mm – 800 mm minor runoff events lost if not harvested, relatively frequent; poor rainfall distribution within season	wide range
Use of water	mainly for agriculture: perennial crops (orchards) but also annual cropland (cereals, pulses and oilseed), and grazing land (stover and failed crops form useful livestock fodder)	for domestic use and for livestock consumption; for agriculture: annual and perennial cropland, rangeland, tree plantations	for agricultural use: suitable for any crop; often perennial tree crop systems (orchards and afforestation), also for annual crops in cereal-based production systems (e.g. millet, sorghum, maize) and fodder bushes	mainly for drinking water, domestic use and livestock consumption limited for agricultural use: mixed cropping – especially horticultural and vegetable crops and trees in kitchen gardens and backyards
Terrain	spate irrigation: where highlands meet alluvial land. downstream areas receive water from upstream catchments in form of floods during heavy rainfall	catchments on slopes and application areas on flatter land or depressions	generally on gentle slopes: both catchment and planted zones which are interspersed; also possible on steeper slopes	all; difficulties with storage facilities on steep slopes; difficulties with underground storage facilities in hard and stony terrain
General slope of catchment area	0-50%	0-50%	0-50%	Any, however should not be too steep
Runoff coefficient	low-medium	low-medium	high	high from all surfaces
Catchment surface	untreated	treated and untreated	natural, cleared and often treated	roofing material: e.g. corrugated galvanized iron sheets, tiles; plastic cover or concrete
Application area	terraced or on flat plains	terraced or on flat plains	lowest point of each system	
Soils	traditional jessour are sited on loess soils and tabias on deep piedmonts soils	cultivated soils must be deep, well-drained and fertile	soils only need to be relatively deep: systems can be applied on highly degraded soils to rehabilitate them – but manure and fertilizers must be added	
Landscape scale	operates at watershed scale district level	operates at household / community level with impacts on the watershed level	household level, local scale	household and community level
Land / water use rights	range from hereditary land rights, government owned rights to private ownership water rights are mainly communal but also individual	individual or communal land ownership mainly communal water rights	individual, to a lesser extent leased or communally managed land  individual or leased water rights	individual or communal land and water use rights
Level of mechanisation	machinery often used for construction of diversions	sometimes mechanised cultivation	none to little	none to little
Labour requirement	high mainly during establishment, maintenance depending on damage by floods	high for many structures during establishment	relatively low labour requirement for establishment but high for maintenance	low absolutely; but quite high per unit area



Level of technical know-how: establishment	high	medium to high	low	low to medium
Level of technical know-how: maintenance	varies greatly	medium to high	medium to low	low to medium
Investment	high to medium – dependent on system	medium to high – dependent on system	low	low to medium – dependent on system
Financial, material and technical support required	high	high for establishment	low to medium depending on system	high for establishment
Examples of costs	spate irrigation (Morocco): 620 – 900 US\$/ha	earth dam (Zambia): 5 US\$/m <sup>3</sup>	stone lines (Niger): 31 US\$/ha	storage tank (Nepal): 25 US\$/m <sup>3</sup>
Examples of benefits	spate irrigation (Ethiopia) yield increase annual crops 170 – 330%	earth dam, weirs (Sahel): yield increase annual crops 30-250%	half-moons and stone lines (Kenya, Burkina Faso): yield increase annual crops 30 – 400%	rooftop with suitable size of storage tank: 22 l/capita/day supply of drinking water. 20 m <sup>2</sup> roof area and 1,000 l jar (Nepal): covers 40,100, 80% of total water needs for 2 to 4 persons in pre-monsoon, monsoon and post-monsoon periods, respectively
Benefit to cost****	short term: negative long term: very positive	short term: negative long term: very positive	short term: slightly positive long term: positive	short term: slightly negative long term: positive
Climate change: resilience and adaptability	key in improving resilience but vulnerable to extreme events; difficult to adapt the system	brings considerable resilience to systems; can be adapted especially through manipulation of C:A ratio	brings considerable resilience to systems; can be adapted especially through manipulation of C:A ratio; but vulnerable to long drought periods	essential ingredient to a very resilient system; very adaptable
Risk reduction	medium	high	high	medium
Main constraints	seasonal variation in rainfall and floods; structures' adaptation to cope with high force floods; possible waterlogging; water rights, allocation of water, conflicts due to complex upstream and downstream interactions	readiness of water users to catch and distribute water during event happening; structures to cope with ephemeral water; losing water through evaporation and seepage of storage structures; stored water can become a source of waterborne diseases; conflicts between (and within) different land users (pastoralists and crop producers)	during heavy rainfall events structures might be irreparably damaged; because of relatively small catchment area these systems will always be vulnerable to prolonged droughts; depending on technology and crop planted has to be repeated each cropping season or annually; requires continuous maintenance; unprotected application area leads to reduced infiltration rates; possible on higher slopes but costs increase quickly with need for higher ridges and bunds	costs of storage facility; losses: size of gutters to handle the flow; contamination of water (needs filtering and protection against contamination);

\* Based on literature review and data from WOCAT database (WOCAT, 2012).

\*\* The most successful water harvesting has been achieved in areas where rainfall is greater than 250 mm per year but less than 1,000 mm (Anderson and Burton, 2009).

\*\*\* Also see Box 8



left and centre: Surface dam, Mongolia.

right: Gully plugging, Niger.

## Adoption and upscaling

### Adoption rate

Adoption rates of WH generally remain low (Box 9). However, some practices such as rooftop WH or certain microcatchment technologies such as planting pits and contour bunds and macrocatchment technologies such as earth dams have spread and continue to do so.

Water harvesting technologies recommended for upscaling must be profitable for users and local communities, and technologies must be as simple and inexpensive as possible: and easily manageable also. Without security of land tenure, water rights and access to markets, land users remain reluctant to invest labour and finances in WH. Cost efficiency, including short and long-term benefits, is another key issue in the adoption of WH practices. Resource users are naturally more willing to adopt practices that provide rapid and sustained pay-back in terms of water, food or income. For example in Sub-Saharan Africa, the most important adoption drivers of water harvesting were found to be yield increase and accessibility to information, followed by secure land tenure (Liniger et al., 2011). Furthermore, it is important to ensure genuine participation of resource users alongside professionals during all stages of implementation to integrate all viewpoints and ensure commitment (Box 10). Often weak approaches and extension have led to poor adoption rates. Water harvesting technologies need to be adapted and fine-tuned to the local natural, socio-economic and cultural environment. Adaptation of standard designs to actual site conditions requires skill and experience, which often will determine the success of the WH practices.

### Enabling environment

In order to facilitate the adoption, adaptation and spread of WH good practices, awareness raising, promotion and training are needed. Financial and material incentives for establishment of certain measures may also be required for small-scale subsistence resource users if costs are beyond their means and if quick benefits are not guaranteed (Box 10). Construction of MacroWH and FloodWH structures often need not only technical support but also financial support since they frequently require high investment costs. The greater the labour and financial needs for maintenance, the less successfully the resource users or local community will adopt the technology: because incentives are commonly only available for the establishment phase. For agricultural WH to contribute to increased incomes and food security,

### Box 9: Adoption trend

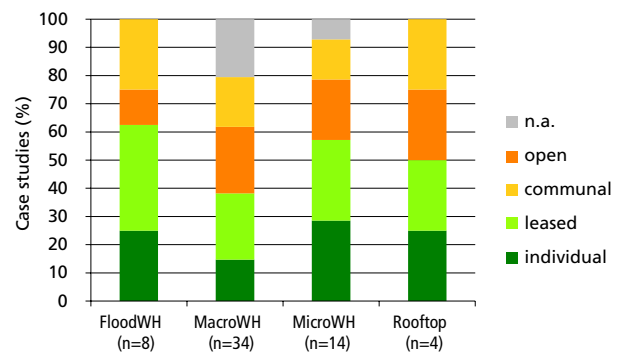

n: number of case studies included in analysis

40-60% of all case studies show moderate to strong adoption rates. MacroWH seems to have lowest adoption which could be related to initial higher investment cost compared to the other groups.

Source: WOCAT, 2012

### Box 10: Enabling environment

#### Key factors for adoption

	FWH	MaWH	MiWH	RCWH
Inputs, material,	+++	+++	++	+++
Incentives, credits	++	+++	+	+++
Training and education	++	+++	+	+++
Land / water use rights	+++	++	+++	+
Access to markets for inputs and outputs	++	++	++	++
Research	++	+++	+	+
Genuine ownership on the part of communities	+++	+++	++	++

Importance: +++ high, ++ medium, + low, +/- neutral

FWH: Flood WH, MaWH: Macrocatchment WH, MiWH: Microcatchment WH, RCWH: Rooftop and Courtyard WH.

Source: Liniger et al., 2011; WOCAT, 2012.

small-scale land users should be assisted to change from purely subsistence farming to partly or fully market-oriented production of higher value crops combined with processing to produce value-added products (Liniger et al., 2011; Oweis et al., 2012; Critchley and Gowing, 2012)

Setting up institutional and policy frameworks creates an enabling environment for the adoption of WH. This involves



HP. Liniger



HP. Liniger

### Box 11: Land use rights

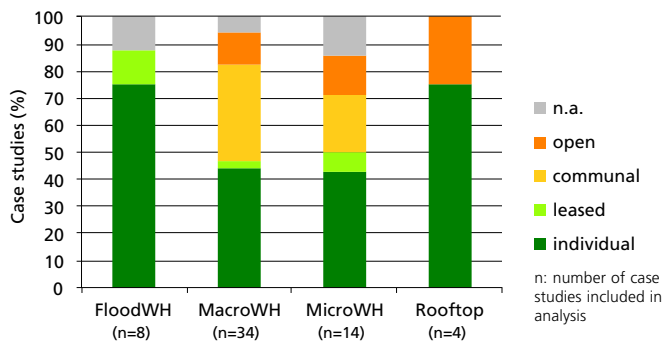

In around half of the cases, Macro- and MicroWH are applied on communal and open access land, whereas the other groups indicate over 75% of the cases on individual land and private property. MicroWH practices are applied for crop production on leased or own land but also for rehabilitation of degraded communal and open access land through tree planting and improved fodder production. Source: WOCAT, 2012

the strengthening of institutional capacities as well as collaboration and networking. Rules, regulations and by-laws need to be established, but must be relevant to be accepted and followed. Resource use rights and access are key to give people individual and / or collective security and motivation for investment (Box 11). The recently released "Voluntary Guidelines on the Responsible Governance of Tenure of Land, Fisheries and Forests in the Context of National Food Security" (CFS, 2012) constitutes an example of growing concern over Sustainable Natural Resource Tenure (SNRT) and how this affects sustainable land management.

#### Promising implementation approaches

A participatory approach contributes to creating an enabling environment for the adoption and sustainability of WH technologies (Box 12). Different approaches are needed in different contexts and it has to be acknowledged that apart from government intervention and donor investments, greater engagement of civil society and empowering stakeholders at grassroots is required. Approaches need to be developed: not selected, transferred or copied: depending on the situation, the people involved, objectives, possible solutions and resources available (Liniger et al., 2011). The following selection of approaches, based on the WOCAT database and described in "Sustainable Land Management in Practice" (Liniger et al., 2011), have been successful and can be more widely adopted for upscaling WH good practices:

### Box 12: Definition of Approach

An approach defines the ways and means of support that help introduce, implement, adapt and apply Sustainable Land Management (SLM) technologies on the ground – be it project or programme initiated, an indigenous system, a local initiative or innovation.

Source: Liniger et al., 2011

**Extension, advisory service and training** can be of different forms: awareness-raising, extension worker to farmer visits, training workshops and seminars around specific themes, exposure visits, hands-on training, the use of demonstration plots, informal farmer-to-farmer extension and exchange of ideas, trained 'local promoters' who become facilitators / extension workers under a project. **Learning for Sustainability (LforS)** is an innovative extension approach for facilitating group learning processes. Its main characteristics are: group learning, learning in the local context, a multi-level and multi-stakeholder approach and an active, process-oriented and situated learning. It is a process-oriented approach that encourages participants to share with each other, to discover common interests and goals, and to develop their own visions (Gabathuler, Bachmann and Klaey, 2011).

**Promoting farmer innovation (PFI)** stimulates technical innovation by farmers. The PFI approach seeks to build on technical initiatives – 'innovations' in the local context: developed by farmers themselves in dry / marginal areas where the conventional approach of 'transfer of technology' from research to extension agents, and then on to farmers, has so often failed. Through contact with researchers, extra value is added to these techniques where possible (Critchley et al., 1999; Liniger and Critchley, 2007)

**Farmer Field Schools (FFS)** is a group learning approach which builds knowledge and capacity among land users to enable them diagnose their problems, identify solutions and develop plans and implement them, with or without support from outside. The school brings together land users who live in similar ecological settings and socio-economic and political situations. FFS provides opportunities for learning-by-doing. Extension workers, SLM specialists or trained land users facilitate the learning process (FAO, 2008; Liniger et al., 2011).

**Water user associations / groups:** Water user association (WUA) and water user group (WUG) are terms used interchangeably to describe broadly the same type of structure,



left: Constructing cover of underground tank, Kenya.  
centre: Rooftop and underground tank of a local church, Kenya.  
right: Water tank, Nepal.



although WUA can be considered as more formalized. Both are organisations for water management made up of small and large-scale water users, such as irrigators, who pool their financial, technical, material, and human resources for operation and maintenance of a local water system, such as a river or water basin. The WUA / WUG is usually run as a non-profit organisation, and membership is typically based on contracts and/or agreements between the members and the WUA / WUG (IWMI and SIC ICWC, 2003). Recent research on water-related rural institutions and organizations is inclined to criticize the tendency to establish formal WUA / WUGs, regarding them as merely 'contracting organisations' under the state – and the even more widespread tendency to advocate them as blueprint solutions in diverse global contexts (Molden, 2007).

**Participatory Land Use Planning (PLUP)** is used for planning of communal or common property, which is particularly important in many communities where communal land and water resources are seriously degraded and where conflicts over user rights exist. Rather than trying to regulate communal lands and water through national policy, new arrangements can be regulated through negotiation among all stakeholders and communally binding rules for SLM, based on planning units, such as social units (e.g. the village) or geographical units (e.g. the watershed) can be developed (Liniger et al., 2011).

**Integrated watershed management (IWM)** is an approach that aims to improve both private and communal livelihood benefits from wide-ranging technological and institutional interventions. The concept of IWM goes beyond traditional integrated technical interventions for soil and water conservation, to include strong institutional arrangements for collective action and market-related innovations that support and diversify livelihoods. This concept ties together the biophysical notion of a watershed as a hydrological landscape unit with that of community and institutional factors that regulate local demand and determine the viability and sustainability of such interventions (Liniger et al., 2011; WOCAT, 2012)

**Multiple-use water services (MUS)** is an approach to water services that considers the multiple needs of water users. This approach considers water from various sources, existing infrastructure and the priorities of the community as the starting point for investments in improved management and governance of water (Van Koppen, 2006, cited in Adank, van Koppen and Smits, 2012). In both the domestic and irrigation sectors MUS started with the growing recognition that

schemes designed for single-use are often used for additional purposes, and become multiple-use schemes. MUS can lead to more sustainable service delivery as it avoids damage from unplanned uses, and better accommodates people's water needs and priorities. The MUS approach has gained wide recognition among global and national policy makers, senior programme managers, development financiers, networks of water professionals, and academia (Adank et al, 2012).

**Payment for Ecosystem Services (PES)** is the mechanism of offering rewards to land users in exchange for managing their land to provide ecological services (Liniger et al., 2011). Those who benefit pay for the services and those who provide, get paid. New PES related markets are emerging globally for:

- Greenhouse gases and carbon (e.g. Clean Development Mechanism (CDM), Reduced Emissions from Deforestation and Degradation (REDD));
- Improved land management in upper watersheds to reduce flooding or water scarcity downstream and reduce sedimentation and siltation of hydropower and irrigation dams (e.g. through watershed management payments, green water credits);
- Biodiversity.

### Upscaling

For upscaling, an enabling environment is of paramount importance. This includes institutional, policy and legal frameworks, local participation as well as regional planning (landscape or watershed), capacity building, monitoring and evaluation, and research. Monitoring and assessment (M&A) of WH practices and their impacts is needed to learn from the wealth of knowledge available including traditional, innovative, project and research experiences and lessons gathered – both successes and failures. M&A can lead to important changes and modifications in approaches and technologies (WOCAT, 2007). Land users have to take an active role as key actors in M&A: their knowledge and judgement of the pros and cons of WH interventions is crucial. M&A of success and failures provides the basis for informed decision making. A multi-stakeholder negotiation approach is the foundation for successful upscaling. It includes all actors, with their various interests and needs with respect to the same resources. It includes local, technical and scientific knowledge and mechanisms to create a negotiation platform.

One concern is the dimension of upscaling. Many efforts rightly support local initiatives and spreading of technologies and approaches on a small-scale with the ultimate aim



of spreading water harvesting and control of desertification. Yet, the size of degraded land, especially rangelands and forests is large, which might also require interventions at larger scale. The approach of Venanzio Vallerani to develop practices that can be implemented as cheaply as possible over a large area and show quick impacts and benefits, deserves attention (personal communication, see case study Part 2). It allows the environment to recover and improve productivity without immediately being threatened by the growing demand. This would justify investment in machinery and large-scale application, as it will reduce the costs per hectare and increase the impact of the improved management. This requires a strong community approach and collaboration of several projects.

## Planning

Water harvesting can be planned and implemented at different scales; from isolated individual plots within fields up to schemes covering a whole watershed or landscape. This has implications for the involvement of land and water users and their right to use their own or communal land and water, and to implement water harvesting structures on their own or on community public land. As long as individuals have access and rights over land and water, they can decide and implement according to their will and the resources available. They may need external support, expertise and training in order to implement WH. This typically applies to rooftop and courtyard WH as well as to microcatchment or in-field WH. For implementation of WH at a larger scale, community mobilisation and involvement is indispensable. There is a fundamental difference between WH interventions based on individual 'autonomy' and those that need community involvement: the latter require different approaches and the attention of implementing agencies. There are potential problems with conflict for 'runoff rights' and impacts on downstream water users. Furthermore larger-scale projects and structures can be difficult to implement as they need acceptance by the majority of land users, political backing and greater financial support (Anderson and Burton, 2009). Current mainstream water resource management (WRM) schools do not sufficiently take WH or its multiple-use water services into consideration – the "blue water agenda" (i.e. irrigation) is more powerful than the "green water agenda" (i.e. rainfed farming). Both are important but green water management needs greater attention. Specific considerations for the planning of water harvesting programmes are summarised in Table 5. In Box 13 key factors for implementation of the different WH groups are compared.

## Box 13: Feasibility and planning

### Key factors for implementation

	FI	Ma	Mi	RC
Assessing water quantity to be harvested	+++	+++	+++	+++
Assessing water quality	+	++	+/-	+++
Estimating water needs	+	+++	++	+++
Site assessment (topography, soils, etc.)	+++	+++	++	+
Financial aspects	++	+++	++	+++
Environmental impact assessment	++	++	+/-	+/-
Land / water use rights	+++	+++	++	++
Neighbourhood relations	+++	+++	+/-	+/-
Community involvement	+++	+++	+	+
Social and gender aspects	+	+	+/-	++
Official governmental approval	+++	+++	+/-	+/-

Importance: +++ high, ++ medium, + low, +/- neutral

FWH: Flood WH, MaWH: Macrocatchment WH, MiWH: Microcatchment WH, RCWH: Rooftop and Courtyard WH.

Source: Liniger et al., 2011; WOCAT, 2012.



left: Water harvesting meeting at farm pond, Laikipia, Kenya.

right: Sharing experiences on microcatchment for fruit trees, Faizabad, Tajikistan.

**Table 5**

**Planning of water harvesting projects: summary of key elements**

<p><b>General</b></p> <ul style="list-style-type: none"><li>• Understand the problems and the specific needs of beneficiaries.</li><li>• Keep project designs flexible and aim for realistic project durations.</li><li>• Identify the scale at which WH will be implemented.</li><li>• Identify and build on existing WH technologies and approaches involving all stakeholders.</li><li>• Keep WH technologies simple and manageable.</li><li>• Promote technologies that have worked in similar conditions.</li></ul>
<p><b>Technical feasibility and biophysical criteria</b></p> <ul style="list-style-type: none"><li>• Rainfall: amount, intensity, duration, distribution, runoff-generating events, evapotranspiration rates.</li><li>• Land topography: slope gradients, length of slopes, size and shape of the catchment.</li><li>• Soil type: infiltration rate, water holding capacity, fertility, soil depth, texture, structure.</li><li>• Collection/ catchment area efficiency and runoff coefficient for the generation of runoff.</li><li>• Land use for catchment and application area: cultivated, uncultivated or partially cultivated, under pasture or forests, etc.</li><li>• Plant water requirements.</li><li>• Level of mechanization required during establishment and maintenance.</li><li>• Availability of local material (stone/ earth etc.) when structural measures are applied.</li><li>• Alternative water sources and family size (specifically for rooftop and courtyard WH).</li><li>• Assurance of good long-term maintenance and management of WH interventions.</li></ul>
<p><b>Economic viability: economic and financial criteria</b></p> <ul style="list-style-type: none"><li>• Evaluate and analyse effectiveness, cost efficiency and benefit to cost ratio.</li><li>• Consider benefits and disadvantages of incentives.</li><li>• Assess availability of labour.</li><li>• Assess access to markets for specific WH inputs and products.</li><li>• Assess need for and access to financial support.</li><li>• Take into account if crop to be grown is 'processable' into value-added products to justify for WH investments.</li></ul>
<p><b>Institutional and legal criteria</b></p> <ul style="list-style-type: none"><li>• Mainstream WH into development projects, investment frameworks, national strategies etc.</li><li>• Encourage coordination and collaboration among stakeholders.</li><li>• Consider legal aspects and land and water use rights.</li><li>• Support capacity building and training for effective and well experienced extension and technical advice services.</li></ul>
<p><b>Socially sound: social and cultural criteria</b></p> <ul style="list-style-type: none"><li>• Take account of cultural differences and local preferences.</li><li>• Integrate socially and economically disadvantaged groups (e.g. women and resource-poor land users).</li><li>• Encourage and support local water user groups to organize themselves.</li><li>• Determine if collective action is needed in the catchment and application area (consider upstream – downstream relations).</li></ul>

Based on IFAD Learning Note No. 10



## Conclusion

With increasing population, climate change, higher food prices and growing shortages of safe drinking water, increasing emphasis must be put on better water management. Water harvesting in particular has high potential: not only for increasing crop production in dry areas, but also in providing drinking, sanitation and household water as well as water for livestock. However, initiatives are still too scattered, and experiences related to “best” WH practices are poorly shared. Policies, legal regulation and governmental budgets often lack the inclusion of water harvesting in integrated water resource management and poverty reduction strategies.

To address water scarcity and growing demands, there is no other option than to improve agricultural production by increasing water availability and water use efficiency in drylands. In addition, provision of water for drinking, domestic and livestock use needs to be decentralized and water itself used more efficiently by harvesting local resources. Today water harvesting is being increasingly promoted as a coping strategy, and both national and international organizations are beginning to invest more in WH for domestic water supply, livestock consumption and for plant production. However, to support and stimulate this development more attention needs to be paid to:

- Facilitating sharing of knowledge and decision support for local implementation and regional planning.
- Upscaling the wealth of WH knowledge and successful WH practices based on informed decision making.
- Demonstrating the benefits of WH, including cost and benefit assessments.
- Capitalizing from local and traditional knowledge, as well as innovations by water users and research.
- Mainstreaming WH implementation into development projects, investment frameworks, national strategies and action plans.
- Building up effective and well experienced extension and technical advice services.
- Encouraging coordination and collaboration among stakeholders.
- Assuring an enabling framework from the policy level: especially securing land and resource use rights.
- Supporting effective decentralization and good governance by offering capacity building and training.

Socio-economic, institutional and human/ cultural aspects as well as appropriate approaches are crucial for successful implementation. Use of subsidies and incentives; capacity building etc. are key aspects behind adoption and upscaling. Standardized documentation of SLM and WH related approaches has been initiated (WOCAT, 2012) and first analyses of these approaches are available (e.g. Liniger and Critchley, 2007; Critchley and Gowing, 2012). However, the focus of these guidelines is on water harvesting technologies. Part 2 presents four water harvesting groups and a selection of case studies of relevant WH technologies.



**left:** Discussion about surface runoff collection, Ethiopia.

**centre:** Hand pump for drinking water next to percolation dam, Kenya.

**right:** Training on documentation and evaluation of water harvesting projects, China.

## References Part 1

### References

- Adank, M., van Koppen, B. and S. Smits. 2012. Guidelines for Planning and Providing Multiple Use Water Services. International Water and Sanitation (IRC) Centre and International Water Management Institute (IWMI). <http://www.musgroup.net>.
- African Development Bank. 2009. Rainwater Harvesting Handbook: Assessment of Best Practises and Experience in Water Harvesting. African Development Bank, Tunis. <http://www.rwsn.ch/documentation/skatdocumentation>
- Anderson, I.M. and M. Burton. 2009. Best Practices and Guidelines for Water Harvesting and Community Based (Small Scale) Irrigation in the Nile Basin. Water Harvesting Report. Part I – Best Practices in Water Harvesting. Part I – Best Practices in Water Harvesting. Appendices. Part II – Guidelines for the implementation of best practices in Water Harvesting. Part II – Guidelines for the implementation of best practices in Water Harvesting. Appendix A: List of Reference Material. Kent, Nile Basin Initiative. Efficient Water Use for Agricultural Production Project (EWUAP).
- Barry, B., Olaley, A.O., Zougmore, R. and D. Fatondji. 2008. Rainwater harvesting technologies in the Sahelian zone of West Africa and the potential for outscaling. IWMI Working Paper 126. International Water Management Institute (IWMI). Colombo, Sri Lanka.
- Botha, J.J., Joseph, L.F., Anderson, J.J. and A.F. Berhanu. 2011. Classification of rainwater harvesting technologies. Paper read at 3rd International Forum on Water and Food, Tshwane, South Africa. CGIAR Challenge Program on Water and Food. Colombo, Sri Lanka.
- CFS (Committee on World Food Security). 2012. Voluntary Guidelines on the Responsible Governance of Tenure of Land, Fisheries and Forests in the Context of National Food Security. Food and Agriculture Organization (FAO). Rome, Italy.
- Critchley, W and J. Gowing. 2012. Introduction. In Critchley, W. and J. Gowing (eds). Water Harvesting in Sub-Saharan Africa. Earthscan.
- Critchley, W. and S. Scheierling. 2012. Water Harvesting for Crop Production in Sub-Saharan Africa: Challenges, Concepts and Practices. In Critchley, W. and J. Gowing (eds). Water Harvesting in Sub-Saharan Africa. Earthscan.
- Critchley, W. and K. Siegert. 1991. Water harvesting. A Manual for the Design and Construction of Water harvesting Schemes for Plant Production. FAO, Rome. <http://www.fao.org/docrep/U3160E/U3160E00.htm#Contents>.
- Critchley, W.R.S., Cooke, R., Jallow, T., Lafleur, S., Laman, M., Njoroge, J., Nyagah, V. and E. Saint-Firmin. 1999. Promoting Farmer Innovation: harnessing local environmental knowledge in East Africa. RELMA/UNDP Workshop Report 2.
- Deryng, D., Sacks, W. J., Barford, C. C., and N. Ramankutty. 2011. Simulating the effects of climate and agricultural management practices on global crop yield. *Global Biogeochemical Cycles*, 25(2), 1–18.
- Falkenmark, M., Fox, P., Persson, G. and J. Rockström. 2001. Water Harvesting for Upgrading of Rainfed Agriculture: Problem Analysis and Research Needs. Stockholm International Water Institute (SIWI) Report 11, Stockholm.
- FAOSTAT. 2012. Database. Food and Agriculture Organization (FAO), Rome. Accessed June 2012. <http://faostat.fao.org/>.
- FAO (Food and Agricultural Organization of the UN). 2008. Farmer field schools on land and water management in Africa. Proceedings an international workshop in Jinja, Uganda. 24 – 29 April, 2006. <ftp://ftp.fao.org/docrep/fao/011/i0383e/i0383e.pdf>.
- FAO. 2001. Water harvesting in Western and Central Africa. Proceedings of a regional workshop held in Niamey, October, 1999. Food and Agricultural Organization of the UN (FAO). Accra, Ghana. <ftp://ftp.fao.org/agl/aglw/docs/waterharvraf.pdf>.
- FAO. 1994. Water harvesting for Improved Agricultural Production. Proceedings of the Food and Agricultural Organization of the UN (FAO) Expert Consultation, November 1993. Cairo, Egypt.
- Faures, J.M. and G. Santini (eds). 2008. Water and the Rural Poor: Interventions for improving livelihoods in Sub-Saharan Africa. Food and Agricultural Organization of the UN (FAO) Land and Water Division and International Fund for Agricultural Development (IFAD), Rome.
- Finkel, H.J. and M. Finkel. 1986. Engineering Measures: Water harvesting. In Finkel, H.J., Finkel, M. and Z. Naveh (eds). *Semi-Arid Soil and Water Conservation*. CRC Press, Inc., Boca Raton, Florida, USA.
- Gabathuler, E., Bachmann, F. and A. Klaey. 2011. Reshaping Rural Extension. Learning for Sustainability (LforS): an Integrative and Learning-Based Advisory Approach for Rural Extension with Small-Scale Farmers. Margraf Publishers.
- Hudson, N.W. 1987. Soil and water conservation in semi-arid areas. Food and Agriculture Organization of the United Nations (FAO). Rome, Italy.
- IFAD. 2011. New realities, new challenges, new opportunities for tomorrow's generation. Rural poverty report 2011. International Fund for Agricultural Development (IFAD). Rome, Italy.
- IWMI (International Water Management Institute). 2008. Areas of physical and economic water scarcity. United Nations Environment Programme (UNEP) / GRID-Arendal Maps and Graphics Library.
- Liniger, H. and W. Critchley (eds). 2007. Where the land is greener: case studies and analysis of soil and water conservation initiatives worldwide. *World Overview of Conservation Approaches and Technologies (WOCAT)*.
- Liniger, H., Mekdaschi Studer, R., Hauert, C. and M. Gurtner. 2011. Sustainable Land Management in Practice. Guidelines and Best Practices for Sub-Saharan Africa. TerrAfrica, World Overview of Conservation Approaches and Technologies (WOCAT) and Food and Agriculture Organization of the United Nations (FAO).
- Molden, D. (ed). 2007. Water for Food, Water for Life: Comprehensive Assessment of Water Management in Agriculture. Earthscan and International Water Management Institute (IWMI). London and Colombo.
- Ngigi, S.N. 2003. What is the limit of up-scaling rainwater harvesting in a river basin? *Physics and Chemistry of the Earth* 28(20-27):943-956.
- Oduor, A.R. and H.M. Gadain. 2007. Potential of Rainwater Harvesting in Somalia. A Planning, Design, Implementation and Monitoring Framework. Project Report No W-09. World Agroforestry Centre (ICRAF). Nairobi, Kenya.
- Oweis, T.Y., Prinz, D. and A.Y. Hachum. 2012. Water Harvesting for Agriculture in the DA. ICARDA, CRC Press/ Balkema, Leiden, the Netherlands.

- Prinz, D. 2011. The Concept, Components and Methods of Rainwater Harvesting (presentation). In 2nd Arab Water Forum "Living with Water Scarcity", 20-23 November, 2011. Cairo, Egypt.
- Prinz, D. 1996. Water harvesting: Past and Future. In Pereira L.S., (ed). Sustainability of Irrigated Agriculture. Proceedings, NATO Advanced Research Workshop, Vimeiro, 21: 26.03.1994. Balkema, Rotterdam.
- Prinz, D. and A. Singh. 2000. Technological Potential for Improvements of Water Harvesting. Contributing paper to the World Commission on Dams. Cape Town, South Africa.
- Rockström, J. 2000. Water resources management in smallholder farms in Eastern and Southern Africa: an overview. *Physics and Chemistry of the Earth* 25(3):275-283.
- Rockström, J., Hatibu, N., Oweis, T.Y., Wani, S., Barron, J., Bruggeman, A., Farahani, J., Karlberg, L. and Z. Qiang. 2007. Managing Water in Rainfed Agriculture. In Molden, D. (ed). *Water for Food, Water for Life: Comprehensive Assessment of Water Management in Agriculture*. Earthscan and International Water Management Institute (IWMI), London and Colombo.
- Scheierling S. (Water Anchor, TWIWA, World Bank). 2011. Adapting Soil-Water Management to Climate Change: Insights from a Portfolio Review (presentation). Learning Session: Climate-Smart Agriculture. Agriculture and Rural Development (ARD) Days 2011.
- Scheierling, S.M., Critchley, W. R. S., Wunder, S. and J.W. Hansen. 2013. Improving water management in rainfed agriculture: Issues and options in water-constrained production systems. Water Paper, Water Anchor, The World Bank.
- Tiffen, M., Mortimore, M. and F. Gichuki. 1994. More people, less erosion, environmental recovery in Kenya. John Wiley & Sons, Chichester, UK.
- Tuinhof, A., van Steenbergen, F., Vos, P. and L. Tolck. 2012. Profit from Storage: the costs and benefits of water buffering. 3R Water Secretariat. Wageningen, The Netherlands.
- Van Steenbergen, F. and A. Tuinhof. 2009. Managing the Water Buffer for Development and Climate Change Adaptation: Groundwater Recharge, Retention, Reuse and Rainwater Storage. UNESCO International Hydrological Programme. Paris.
- Van Steenbergen, F., Lawrence, P., Haile A.M., Salman, M. and J-M.Faurès. 2010. Guidelines on Spate Irrigation. (Food and Agricultural Organization of the UN) FAO. Rome, Italy. <http://www.fao.org/docrep/012/i1680e/i1680e.pdf>.
- Von Grebmer, K., Ringler, C., Rosegrant, MW., Olofinbiyi, T., Wiesmann, D., Fritschel, H., Badiane, O., Torero, M., and Y. Yohannes (International Food Policy Research Institute, IFPRI); Thompson, J. (Concern Worldwide); von Oppeln, C. and Rahall, J. (Welthungerhilfe and Green Scenery). 2012. Global Hunger Index: The challenge of hunger: Ensuring sustainable food security under land, water, and energy stresses. Washington, DC. [http://www.ifpri.org/sites/default/files/ghi12\\_scores\\_severity.pdf](http://www.ifpri.org/sites/default/files/ghi12_scores_severity.pdf).
- Wani, S.P., Sreedevi, T.K., Rockström, J. and Y.S. Ramakrishna. 2009. Rainfed Agriculture – Past Trends and Future Prospects. In Wani, S.P., Rockström, J. and T. Oweis (eds). *Rainfed Agriculture: Unlocking the Potential. Comprehensive Assessment of Water Management in Agriculture* 7.
- WB (World Bank). 2012. Rainfed Agriculture. Accessed June 2012. <http://water.worldbank.org/topics/agricultural-water-management/rainfed-agriculture>.
- Worm, J. and T. van Hattum. 2006. Rainwater harvesting for domestic use. AGROMISA and CTA / RAIN (Rainwater Harvesting Implementation Network). Wageningen, The Netherlands.
- WRI (World Resources Institute). 2012. Where are the world's drylands? Accessed June 2012. <http://www.wri.org/publication/content/8236>.

### Complementary references

- Agarwal, A., Narain, S. and I. Khurana (eds). 2001. *Making Water Everybody's Business: Practice and policy of water harvesting*. Centre for Science and Environment (CSE). New Delhi, India.
- Agarwal A. and S. Narain. (eds). 1997. *Dying Wisdom: Rise, fall and potential of India's traditional water harvesting systems*. Centre for Science and Environment (CSE), New Delhi, India.
- Batchelor, C., Fonseca, C. and S. Smits. 2011. Life-cycle costs of rainwater harvesting systems. Occasional Paper 46 (online). IRC International Water and Sanitation Centre / Water, Sanitation and Hygiene (WASH)Cost / Rainwater Harvesting Implementation Network (RAIN). The Hague, The Netherlands. <http://www.irc.nl/op46>.
- Barron, J. 2009. Rainwater harvesting: a lifeline for human well-being. United Nations Environment Programme (UNEP), Nairobi / Environment Institute (SEI), Stockholm.
- Beernaerts, I. (ed). 2008. Model on "Economic analysis of rainwater harvesting for crop production" : FAO Sub-regional Office for West Africa (SFW).
- Benicke, C. 2001. Costs and Benefits of Adopting Runoff Irrigation Systems. Universität Bayreuth, Germany.
- Critchley, W. and J. Gowing (eds). 2012. *Water Harvesting in Sub-Saharan Africa*. Earthscan.
- Critchley, W.R.S. 2010. *More People, More Trees: Environmental recovery in Africa*. Practical Action Publishing, Rugby, UK.
- Gould, J. and Nissen-Petersen, E.. 1999. *Rainwater Catchment Systems for Domestic Supply: Design, construction and implementation*. IT Publications, London.
- IFAD. 2011. *New realities, new challenges, new opportunities for tomorrow's generation. Rural poverty report 2011*. International Fund for Agricultural Development (IFAD). Rome, Italy.
- Koohafkhan, P. and B.A. Stewart. 2008. *Water and Cereals in Drylands*. Earthscan, London.
- Oweis, T.Y. 2009. Managing water resources under scarcity and climate change. Presentation for IFAD-ICARDA knowledge and technology exchange in NENA region.
- Oweis T and A. Hachum. 2006. Water harvesting and supplemental irrigation for improved water productivity of dryfarming systems in West Asia and North Africa. *Agricultural Water Management* 80(1-3):57-73.
- Potsdam Institute for Climate Impact Research and Climate Analytics. 2012. Turn Down the Heat: Why a 4°C Warmer World Must be Avoided. International Bank for Reconstruction and Development / The World Bank; Washington D.C.
- Van Steenbergen, F., Tuinhof, A. and L. Knoop. 2011. *Transforming Lives Transforming Landscapes: the Business of Sustainable Water Buffer Management*. 3R Water Secretariat. Wageningen, The Netherlands.

# Part 2









HP. Liniger

# Part 2: Water Harvesting Applied

## Introduction

Harmonised and standardised documentation of the wealth of experiences in water harvesting (WH) facilitates knowledge sharing, exchange, evaluation, direct comparison and identification of knowledge gaps. A well-structured and user-friendly database helps give access to knowledge; its analysis then assists informed decision making, dissemination and upscaling. In Part 2 the WH groups and technologies introduced in Part 1 are presented in such a standardised way: based on the World Overview of Conservation Approaches and Technologies (WOCAT) methods and tools. First a structured overview and short description of relevant and common technologies within each of the WH groups is given. Some less well-known, localized technologies that are relevant to some users were not included in this edition of the guidelines. Such technologies include dew, fog and snow harvesting, coastal tide harvesting, and so forth. Furthermore these guidelines are biased towards information and knowledge that is published in English, and to a lesser extent in French. It might, therefore, not give adequate consideration to WH technologies and practices that are widespread and/or of local importance in countries where information is recorded in other languages: thus in Spanish (Latin America), Portuguese (Brazil), Russian, Chinese, Arabic and other languages.

The overview of technologies is followed by standardised presentation of a selection of site-specific WH practices, termed case studies. This presentation (in the form of a 4-page summary) can be automatically generated from the publically accessible WOCAT database, which hosts the documentation of Sustainable Land Management (SLM) Approaches and Technologies, under which water harvesting practices fall. A case study consists of a description, technical specifications, implementation activities, costs, an overview of the natural and human environment as well as an analysis of impacts, economics and adoption of the technology applied in a specific context.

This publication is a guide: and as the name suggests it provides guidelines to good practice. It does not propose silver bullet solutions, nor give step-by-step “how to do” instructions. There are many variations and adaptations of the technologies presented: already existing, local innovations, research-based, or still to be explored possibilities. These guidelines are only a starting point and far from being comprehensive. They demonstrate the value of a worldwide knowledge sharing platform and standardised methods and tools for knowledge management. The data available in the WOCAT global database and additionally compiled local experiences can form the basis for informed decision making for upscaling of WH good practices at local and national level. For sound decision making it is necessary to analyse not only so-called “successful” examples, but also those which may be considered – at least partially – “failures”. The reasons for failure are equally important for analysis. We could start this by complementing and expanding these guidelines towards a new edition.



**left:** Animals drinking from surface dam, Rajasthan, India.







**right:** Illustration of various water harvesting and conservation practices, Laikipia Research Programme / Laikipia Rural Development Programme, Kenya.

# Content of Part 2





## Case studies – titles and short descriptions

### WH Technology

#### Floodwater Harvesting

	Eritrea	<p><b>Spate irrigation</b> A traditional water diversion and spreading technique under which seasonal floods of short duration are diverted from ephemeral rivers (<i>wadis</i>) to irrigate cascades of levelled and bunded fields in the coastal plains.</p> <p style="text-align: right;">p 45</p>
	Ethiopia	<p><b>Runoff and floodwater farming</b> Flood water and runoff from ephemeral rivers, roads and hillsides is captured through temporary stone and earth embankments for growing vegetables, fruit trees and high value crops.</p> <p style="text-align: right;">p 49</p>
	Spain	<p><b>Water harvesting from concentrated runoff for irrigation purposes</b> Small earthen- or stone-built bunds divert flood water from intermittent streams towards cultivated fields with almond orchards and/or cereals.</p> <p style="text-align: right;">p 53</p>
	Chad	<p><b>Water-spreading weirs for the development of degraded dry river valley</b> Structures that span the entire width of a valley to spread floodwater over the adjacent land area.</p> <p style="text-align: right;">p 57</p>
	Tunisia	<p><b>Jessour</b> An ancient runoff water harvesting technique widely practiced in the arid highlands.</p> <p style="text-align: right;">p 63</p>
	Tunisia	<p><b>Tabia</b> The <i>tabia</i> earthen dyke is a water harvesting technique used in the foothill and piedmont areas.</p> <p style="text-align: right;">p 67</p>

#### Macrocatchment Water Harvesting

	India	<p><b>Sunken streambed structure</b> Excavations in streambeds to provide temporary storage of runoff, increasing water yields from shallow wells for supplementary irrigation</p> <p style="text-align: right;">p 91</p>
	Zambia	<p><b>Small Earth Dams</b> Water harvesting and storage structures, constructed across narrow sections of valley, to impound runoff generated from upstream catchment areas.</p> <p style="text-align: right;">p 95</p>
	Kenya	<p><b>Sand dams</b> A sand dam is a stone masonry barrier across a seasonal sandy riverbed that traps rainwater and sand flowing down the catchment.</p> <p style="text-align: right;">p 99</p>
	Tunisia	<p><b>Recharge well</b> Drip irrigation is a method designed for minimum use of water and labour for the optimum irrigation of plants in arid and semi-arid regions.</p> <p style="text-align: right;">p 105</p>

## Case studies – titles and short descriptions

### WH Technology

#### Microcatchment Water Harvesting



Niger

##### Planting pits and stone lines

Rehabilitation of degraded land through manured planting pits, in combination with contour stone lines.

p 123



Syria

##### Furrow-enhanced runoff harvesting for olives

Runoff harvesting through annually constructed V-shaped microcatchments, enhanced by downslope ploughing.

p 127



Burkina Faso

##### Vallerani system

A special tractor-pulled plough that automatically constructs water-harvesting catchments, ideally suited for large-scale reclamation work.

p 131



Kenya

##### Fanya juu terraces

*Fanya juu* terraces comprise embankments (bunds), which are constructed by digging ditches and heaping the soil on the upper sides to prevent loss of soil and water.

p 137

#### Rooftop and Courtyard Water Harvesting



Botswana

##### Roof rainwater harvesting system

Roof rainwater catchment system using galvanised iron roof material, feeding an underground water tank.

p 159



Nepal

##### Rooftop rainwater harvesting system

A water harvesting system in which rain falling on a roof is led through connecting pipes into a ferro-cement water collecting jar.

p 163



Tajikistan

##### Roof top rainwater harvesting stored in a polyethylene lined earth retention tank

The use of an earth tank lined with a polyethylene sheet to retain rainwater collected from the roof of the house.

p 167



Tajikistan

##### Roof Top Rain Water Harvesting – Concrete Tank

The roof top rain water harvesting system using a concrete tank was designed to improve household access to water for irrigation of kitchen garden plots during the hot and dry summer months.

p 171



# FLOODWATER HARVESTING



Spate irrigation in Yemen. (spate-irrigation.org)

## In a nutshell

### Short description

In floodwater harvesting systems (FloodWH), storm floods caused by runoff from mountainous catchments are channelled through diversions to bunded basins on cropped land. By transporting sediments from the catchments to croplands, these systems “grow” their own nutrient-rich soil. These systems play an important role in many arid and dry semi-arid regions worldwide – and the majority are traditional schemes. However, they are less widespread and less strongly promoted than micro- and macrocatchment systems. An important reason is the more demanding planning at the watershed scale, and the large volumes of water that must be managed – with the associated risks of serious erosion when flows breach barriers. Such systems depend on collective action between upstream and downstream land users and involve high labour input for annual maintenance. Despite the uncertainties regarding the timing and level of flooding, FloodWH technologies can sustain highly productive agricultural systems: centuries of tradition testify to this.

### Water storage and purpose

Once floodwater is diverted to the cultivated area, it is stored in deep alluvial soils formed from the sediments deposited by previous floods. Annual crops, often under agroforestry systems, are then grown with the captured moisture. Alternatively, floodwater harvested within gullies / watercourses is stored in the sediment above structures and used to support the growth of trees, bushes or fodder crops.

### Most common technologies

Flood recession farming and spate irrigation – where floodwater is deliberately diverted from the watercourse – are the most common amongst all FloodWH technologies. Water spreading weirs are known in parts of West Africa. Within streambed technologies such as *jessour*, *tabias* or “warping” are also well-known.

### Applicability

The diversion of floodwater is common in semi-arid and arid environments with extreme and highly variable rainfall regimes. It is often located where mountain catchments border plains: these downstream areas receive water from upstream catchments in the form of floods during heavy rainfall events.

### Resilience to climate variability

An increase in flood events may provide more opportunities for FloodWH. However, if floods are too large, they can destroy diversion structures. Prolonged dry spells and droughts will increase insecurity because of the decreased number of floods.

Improved water availability	
Drinking water (high quality)	n/ap
Domestic use (household)	n/ap
Livestock sedentary	n/ap
Livestock pastoral	+
Rainfed agriculture	+++
Opportunistic irrigation	+++
Supplementary irrigation	+
Irrigation of backyard crops / kitchen gardens	n/ap
Aquifer recharge	+++
Development issues addressed	
Preventing / reversing land degradation	+
Maintaining and improving food security	+
Reducing rural poverty	+
Creating rural employment	+
Supporting gender equity / marginalised groups	+/-
Reduced risk of production failure	+
Improving crop production (including fruit trees)	++
Improving fodder production	+
Improving wood / fibre production	+
Improving water productivity	+
Trapping sediments and nutrients	+++
Enhancing biodiversity	+
Natural disaster prevention / mitigation	++
Climate change mitigation	++
Climate change adaptation	
Resilience to extreme dry conditions	+/-
Resilience to variable rainfall	+
Resilience to extreme rain and wind storms	++
Resilience to rising temperatures and evaporation rates	++

Importance: +++ high, ++ medium, + low, +/- neutral, n/ap: not applicable

### Main benefits

- FloodWH uses water which upstream users often do not require or cannot retain, as rainfall during the periods of water harvesting is abundant. FloodWH is therefore a good opportunity to provide low cost water that is not needed upstream.
- Permits cultivation of large areas.
- Floods, and thus associated negative impacts such as erosion downstream, can be partially controlled.
- Deposition of sediments carried with the floodwater builds up nutrient-rich soils.
- Excess floodwater – not immediately used for production – contributes to aquifer recharge.

### Main disadvantages

- FloodWH technologies are risk-prone due to the high unpredictability in numbers, volumes and timings of floods.
- Occasionally high floods can destroy water diversion structures.
- High sediment loads clog intake structures and diversion channels; diversion structures have to be repaired or replaced regularly, often each season, and require considerable labour for maintenance.
- Floods diverted sometimes lead to negative impacts on downstream ecosystems.

### Benefit-cost ratio

Technology	short term	long term
Floodwater diversion	–	+++
Within streambed	– /+	+++
Overall	–	+++

– – – very negative; – – negative; – slightly negative; –/+ neutral; + slightly positive; ++ positive; +++ very positive; (WOCAT, 2012).

Initial investments can be high for labour. And if permanent structures such as dykes are included, then mechanised construction may be required and costs rise accordingly. Therefore the benefit-cost ratio may only be positive in the long term. As many land users implementing FloodWH technologies provide labour, and do not have to pay for it in cash, they may nevertheless perceive the short-term benefits as positive. Larger-scale structures are often implemented by governmental agencies.

### Adoption and upscaling

Due to increasingly variable rainfall and degradation leading to the drying up of perennial rivers, some land users in Sub-Saharan Africa rely more and more on FloodWH for opportunistic irrigation of their fields. However, high initial investments and labour requirements for maintenance hinder many land users from adopting such practices, as may the lack of know-how.



Spate irrigation scheme in Yemen. (UNESCO-IHE)



Blocking scour sluice on a modernised spate irrigation system in Yemen. (spate-irrigation.org)



Water spreading weir in the Sahel. (H. Bender)

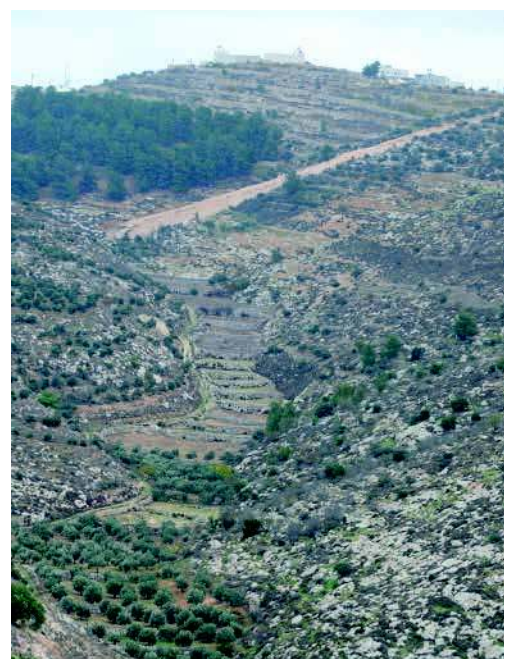

Warping dams, Palestine. (N. Harari)



Flood recession farming, Burkina Faso. (HP. Liniger)

## Technology

**Flood recession farming (wild flooding):** In some rainfed areas plants and crops growing along rivers, their tributaries and deltas (such as Niger, Zambezi, Nile, etc. in Africa; Mississippi, Mekong, Indus), ephemeral riverbeds and around lakes profit from flooding (opportunistic irrigation) and make use of residual moisture after flood retreat. Flood recession farming occurs in different parts of the world and can sustain large populations (e.g. Bangladesh, Mali, Mexico, India).

**Inland valleys** and/or swamps refer to the flat-floored and relatively shallow valleys or depressions, which receive water from the surrounding natural sloping surfaces. Inland valleys are traditionally used to produce lowland rice (in swamps) and fodder, but they can also be used for crop and tree cultivation. In Sub-Saharan Africa they are known by *bas fond*, *marias*, *petit vallée* or *marigot* in French and *fadama*, *vlei*, *dambo*, *boli*, *mbuga*, etc in local languages. In Turkmenistan they are called *oytak*.

### Floodwater diversion – off-streambed

**Spate irrigation** is an ancient form of WH. It is a method of managing unpredictable and potentially destructive flash floods for crop and livestock production. Floodwater from mountain catchments is diverted from ephemeral riverbeds (*wadis/koris*) and spread over large areas, often in lowland plains, to irrigate crops. The technology makes use of seasonal floods of short durations. In the application area, where water is concentrated, water soaks into the soil and provides residual soil moisture for crop growth, allowing for up to three crop harvests per year if floods occur several times. Planting is carried out after the first floodwater has subsided. Spates can also fill ponds for use by humans and livestock.

Spate irrigation practices can consist either of temporary or permanent headwork (at the diversion structure in the riverbed). While the former includes soil bunds, small/sized gabion structures and diversion canals, the latter comprises concrete diversion weirs, bunds and siphons. Spate systems are risk-prone by nature just as they are opportunistic. The uncertainty comes both from the unpredictable nature of the floods and the frequent changes to the riverbeds from which the water is diverted. People whose livelihood and food security depends on spate flows often belong to the poorest segment of the rural population. Substantial local knowledge has developed in organizing spate systems and managing both the floodwater and the heavy sediment loads that go along with it.



Inland valley rice cultivation, Cercle de Sikasso, Mali. (Africa Rice Center)

### Example: Spate irrigation in Pakistan

In Pakistan, sporadic floods from temporary rivers are diverted and spread over a large area of land by earthen bunds, about 1 km long, several metres high and up to 20 m wide at the base. Water is guided through a system of flood channels to the bunded fields, often as large as 15 hectares, sub-divided into sections (Waes and Bouman, 2007).



Spate irrigation fields in Pakistan. (spate-irrigation.org)



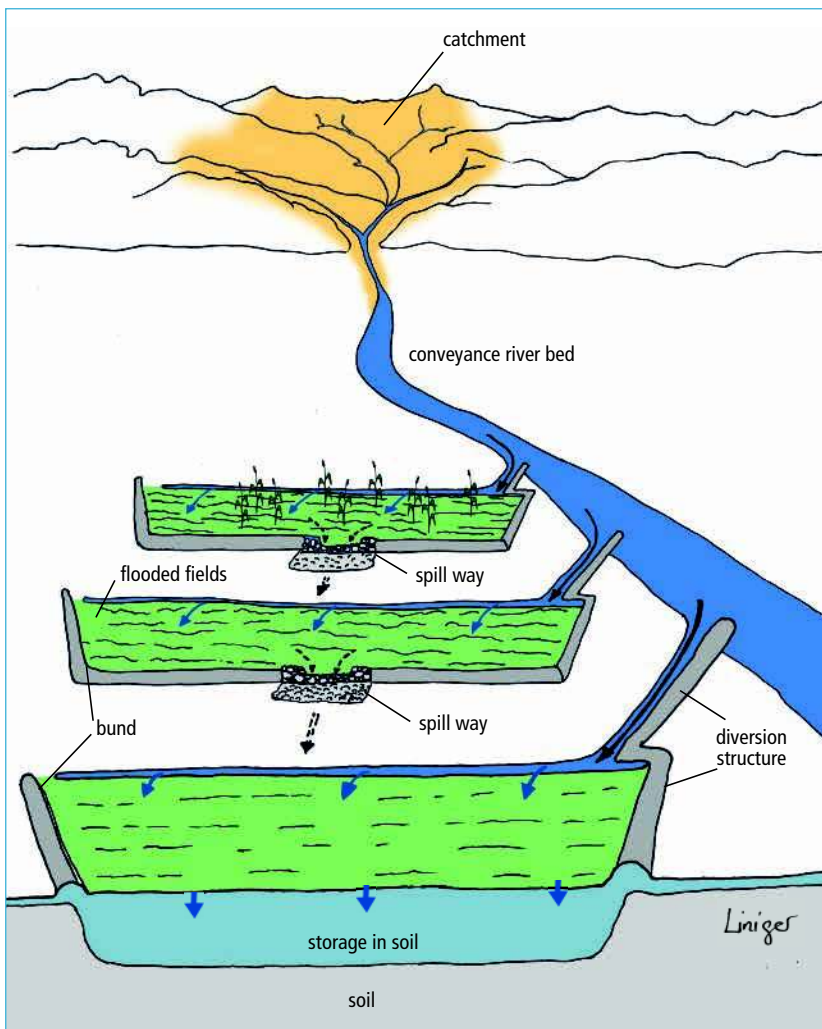

Spate irrigation system.

**Water spreading weirs** span the entire width of a valley and are built of stone masonry or concrete up to 50 cm above the surface of the surrounding sand. They consist of a spillway in the actual riverbed and lateral abutments and wings. Floodwater is spread over the land area upstream of the structure and eventually overflows the lateral wings and then slowly flows back towards the riverbed below the structure. Spreading weirs are effective when built in series of weirs, where each weir retains some of the water and alluvial deposits (fertile soils) and gradually raises the bed of the valley. Water spreading weirs slow the water flow and increase the regularly flooded area. They enable rainwater to be stored by seeping into the ground and raising the level of the groundwater table close to the surface. They are suited for the rehabilitation of wide and shallow dry valleys in which severe gully erosion prevents regular flooding. They are also suitable for improving agricultural productivity in more or less intact valley floors. Designing and constructing weirs requires significant technical knowledge and their implementation calls for well organised communities. In Niger, Chad and Burkina Faso, more than 370 water spreading weirs have been implemented covering an improved cultivation area of more than 20,000 ha benefitting more than 40,000 households (GIZ, 2011). In West Africa they are well known as *seuils d'épandage*.

**Water spreading bunds:** The main characteristic of water spreading bunds is that, as their name implies, they are intended to spread water, and not to impound it. They are usually used to spread floodwater, which has either been diverted from a watercourse or has naturally spilled onto the floodplain. The bunds, which are usually made of earth, slow down the flow of floodwater and spread it over the land to be cultivated, thus allowing it to infiltrate over an increase area. Water spreading bunds may be part of a spate irrigation scheme – or, where natural flooding occurs, they may constitute a technology in themselves.

### Example: Spate irrigation in Spain

In Spain, traditional water harvesting structures are being restored to combat the problem of water shortages. Many of these structures were widely used during Arab and Roman times, but they were abandoned and forgotten. The technology basically consists of a small earthen or stone bund that diverts floodwater from intermittent streams towards fields cultivated with almond orchards and/or cereals. Depending on the slope and the amount of water to be harvested, the fields are organised as single terraces, or as a series of terraces. Water is diverted from one terrace to the next through small spillways in the terrace wall. The spillways are fortified with stones to prevent gully formation. The extra input of surface water can double the almond yield ( J. de Vente in Schwilch et al., 2012; WOCAT, 2012).



Traditional channel system (*acequia*) directing diverted flood water (by earthen or stone bunds) from intermittent streams towards almond terraces, Spain. (J. de Vente)



Water spreading weir in the Sahel (GIZ, 2011).



Water spreading weirs built in series (GIZ, 2011).



View of an area with a number of *jessours* in Tunisia. (M. Ben Zaijed)

### Floodwater harvesting within streambed

**Riverbed / wadi reclamation:** the riverbed is used to store the water either on the surface by blocking water flow or in the soil profile by slowing the flow and allowing it to infiltrate in the soil. This occurs naturally or by constructing small dams or dykes across the riverbed to reduce the velocity of water flow and at the same time encourage sedimentation which in turn improves fertility and allows planting of high value fruit trees and/or crops. This technology is common in riverbeds with mild slopes.

**Jessour systems** are located in upper zones of (semi) arid highlands with steeper slopes and are a variation of riverbed reclamation. They consist of three components: the catchment, the terrace and the dyke. The dyke (also called *tabia*) made from soil, rock, or gabions, is either built across seasonal stream channels or at the foot of slopes. Fertile sediments accumulate behind the dykes allowing the cropping of trees and annual crops. The *jessour* system is used for the cultivation of a number of trees including olives, figs, almonds, and palms – as well as legumes (peas, chickpeas, lentils and faba bean), and cereals (wheat and barley). The cropping area is in the range of 0.2–5 ha and the ratio of the catchment to application / target area varies from 100:1 to 10,000:1. The main functions of *jessours* are: (1) soil moisture increase for crops; (2) groundwater recharge through infiltration in the terraces and (3) flood control and therefore protection of downstream infrastructure. Similar systems, called “warping” and *gavias*, exists in the loess plateau of China and in arid zones of the Canary archipelago, respectively.

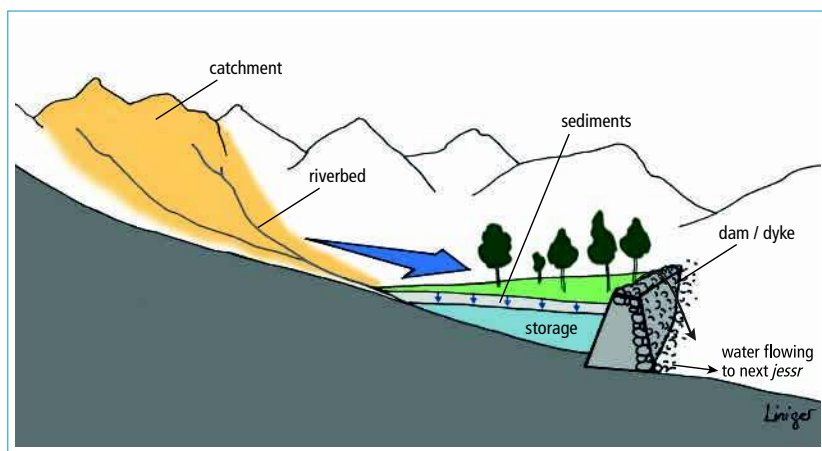

Cross-section of a *jessours* or warping dam system (*jessr* = singular).

### Example: Warping dams in the Loess Plateau of China

The Loess Plateau covers an area of 640,000 km<sup>2</sup> in north central China and is home to more than 50 million people. The intense use of the Plateau and the lack of conservation measures have led to large-scale degradation of the vulnerable land formations. One element of the governmental rehabilitation programme of the Loess Plateau is the construction of warping dams. Warping dams are dams built on gullies to harvest and intercept sediments and thereby create new land. The dams are of considerable height – typically up to five metres. The number of dams depends on the slope and width of the gully. The development of a warping dam consists of two stages: (a) the land development stage that takes several years, and (b) the consolidation and management stage. The development requires an area approach. It is important to look at existing measures and natural factors in the area (e.g. cropping systems, slopes, upstream and downstream users) (Van Steenberg et al., 2011a).



Warping dams in Xifeng county, province of Gansu after establishment of the structures. (L. Xiaobo)

**Tabia** floodwater spreading systems are usually installed on gentle slopes either at the foot of mountains, adjacent to or within wide riverbeds in lower part of the watershed, where the gradient does not exceed 3%, and the soils are relatively deep. *Tabias* comprise a dyke (50–150 m in length, 1–1.5 m in height), a spillway (central and/or lateral) and an application area. Fruit trees and annual crops are commonly grown using *tabia*. Besides their benefits for water harvesting, *tabias* reduce soil erosion and have a positive effect on groundwater recharge.

**Permeable rock dams:** Long low but broad rock dams across valleys slow and spread floodwater as well as heal gullies. They are suitable for situations where gently sloping valleys are becoming incised. Thus water is drained and lost from the land surrounding the gullies. Each dam is usually between 50 and 300 m in length. The dam wall is usually over 1 m in height within a gully, and between 80 and 150 cm in height elsewhere. The dam wall is also flatter on the downslope side (2:1, 3:1) than on the upslope side (1:1, 1:2), to give better stability to the structure when it is full. A shallow trench for the foundation improves stability and reduces the risk of undermining. Large stones are used on the outer wall and smaller stones internally. The main limitation of permeable rock dams is that they are particularly site-specific, and require considerable quantities of loose stone as well as the provision of transport.



Mechanical construction of a *tabia* dyke, Tataouine, Tunisia. (M. Ouessar)



Permeable rock dam, Rajasthan, India. (HP. Liniger)



Constructing a permeable rock dam (*digue filtrante*) in Burkina Faso. (W. Critchley)

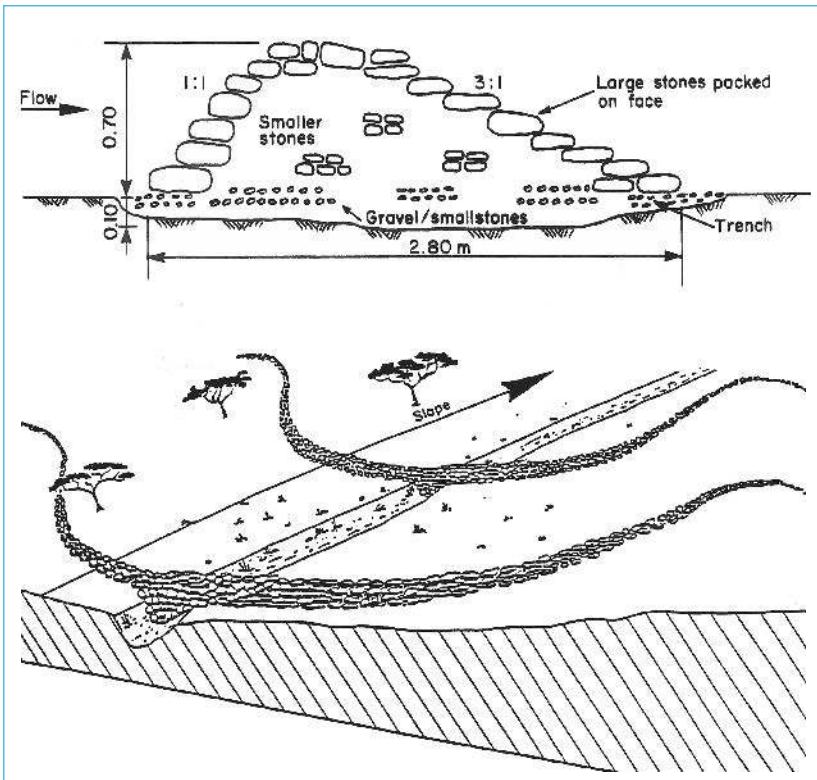

Top: permeable rock dam dimensions  
Bottom: general layout  
(Critchley and Siegert, 1991).

## Spread and applicability

### Spread

#### Floodwater off-streambed diversion

**Spate irrigation** is unique to arid regions bordering highlands. The area under spate irrigation is more than 2.5 million hectares worldwide with about 2.1 million households (11 million people) depending on it (Spate Irrigation Network). It is common in West Asia (e.g. Afghanistan, **Iran, Pakistan**), the Middle East (e.g. Saudi Arabia, **Yemen**), North Africa (e.g. Algeria, Egypt, **Morocco**, Tunisia (*mgoud*)), the Horn of Africa (e.g. Eritrea, **Ethiopia, Somalia** (*deshek*), Sudan), and more sporadically in East Asia (e.g. China, Mongolia, Myanmar, Nepal), Central Asia (e.g. Kazakhstan), East Africa (e.g. Kenya, Tanzania), West Africa (e.g. Burkina Faso, Mauritania, Senegal), South America (e.g. Bolivia, Chile, Mexico) and Europe (e.g. Spain (*boquera*)).

**Spreading weirs:** West Africa (e.g. Burkina Faso, Chad, Niger), South America (e.g. Brazil), Yemen, etc.

#### Floodwater harvesting within streambed

**Riverbed reclamation:** e.g. Israel, Lybia, Morocco, Palestine, Tunisia (*jessour* and *tabia*), China ("warping" dams), Canary archipelago (*gavias*), Ethiopia, etc.

**Permeable rock dams:** e.g. Burkina Faso (*digues filtrantes*).

### Applicability

**Land use:** FloodWH is mainly used for annual crops or mixed crops, for fruit trees, or timber and firewood trees. It is also used for pasture or forest land. Annual crops grown under FloodWH include: cereals (sorghum, pearl millet, wheat, barley), pulses (green grams, chickpeas, cluster beans), oilseed crops (castor, mustard, sesame, rapeseed) as well as cotton, cucurbits, tomatoes and other vegetables. Fruit trees grown include: olives, almonds, figs, date palms, etc. In some areas FloodWH is used to spread water for pasture or forest land.

**Water use:** Flood recession farming and recharge of shallow aquifers.

**Climate:** Arid to semi-arid with annual precipitation of 100–700 mm, where evapotranspiration greatly exceeds rainfall.

**Terrain:** Spate irrigation is often found where highland plains meet alluvial flat slopes on deep loams to silt loams; *jessours* are often used on loess soils, *tabias* on deep footslope soils. Catchment areas are often steeper than the application / cropped area which is situated on medium to flat slopes.

**Scale:** FloodWH systems operate at the watershed scale.

**Level of mechanisation:** Mainly manual labour; sometimes animals or tractors are used (e.g. in Eritrea, Spain, Sudan).

**Land ownership and land / water use rights:** FloodWH systems are used by sharecroppers and tenants as well as by landowners. The land use rights under which FloodWH is implemented range from hereditary land rights (e.g. Pakistan), government-owned rights (e.g. Eritrea, Ethiopia, Sudan) to private ownership (e.g. Yemen). In the case of *tabias* land ownership is often individual and titled.

**Skill / knowledge requirements:** Development of local regulations, and organization and cooperation at the community level are prerequisites for the successful management of FloodWH systems. For the appropriate design of the structures the area of the catchment and potential application area must be calculated as well as hydrological aspects such as peak discharge. Highly skilled technical knowledge is needed – and local experience is a vital help. Advisors and project planners need good skills and close collaboration with local land and water users.

**Labour requirements:** Reconstruction of canals, intakes and diversion structures both before and after flood events is very labour intensive.

#### Land use

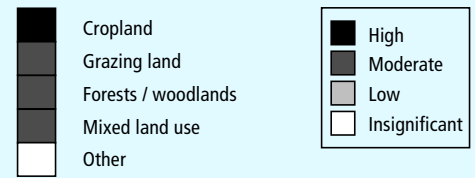

#### Water use

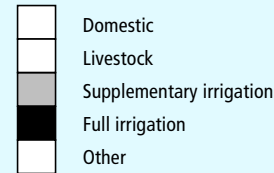

#### Climate

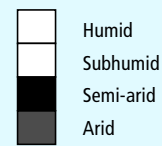

#### Average rainfall (mm)

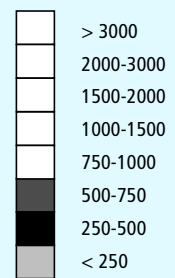

#### Slope of catchment (%)

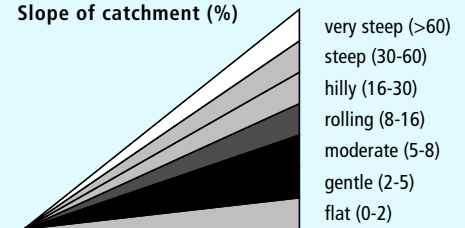

#### Scale

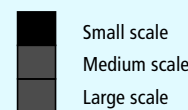

#### Land ownership

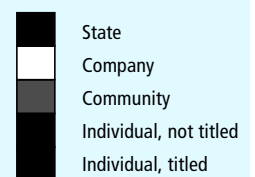

#### Mechanisation

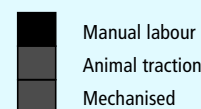

#### Market orientation



#### Required labour

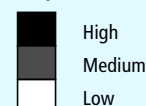

#### Required know-how

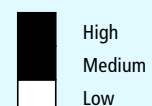

## Economics

### Costs

A typical rock dam in Africa providing water supply to plots of 2 to 2.5 ha and control of erosion costs about US\$500 to 650 for transportation of material and about 300 to 600 person days of labour (IWSD, 1998).

Technology	Country	Establishment costs US\$/ha	Maintenance costs US\$/ha/year
Spate irrigation	Pakistan <sup>1</sup>	10 – 300	10 – 40
Spate irrigation	Iran <sup>2</sup>	160 – 180	approximately 10
Spate irrigation	Morocco <sup>3</sup>	620 – 895	54 – 88
Spate irrigation with non-permanent headwork *	Ethiopia <sup>4</sup>	170 – 220	
Spate irrigation with permanent diversion structure *	Ethiopia <sup>4</sup>	330 – 450	
Spate irrigation	Spain <sup>5</sup>	900 per bund (machine use, concrete, labour)	41
Spate irrigation	Eritrea <sup>6</sup>	60 per 10 m diversion structure (without labour)	50 – 95 per 10 m diversion structure (without labour)
Floodwater spreading	Iran <sup>4</sup>	250 – 1,800	
Water spreading weirs	Sahel <sup>7</sup>	20,000 – 70,000 per structure 800 and 2,000 per ha improved land	
Tabia	Tunisia <sup>5</sup>	670 (mainly labour)	200
Jessour	Tunisia <sup>5</sup>	1,920 (mainly construction material for dyke)	900

<sup>1</sup> Waes and Bouman, 2007; Van Steenberg et al., 2010; <sup>2</sup> Kowsar, 2011; <sup>3</sup> Oudra, 2011; <sup>4</sup> Van Steenberg et al., 2011b; <sup>5</sup> Schwilch et al., 2012; <sup>6</sup> Liniger et al., 2011; WOCAT, 2012; <sup>7</sup> GIZ, 2011; Tuinhof et al., 2012.

\* The cost varies from place to place. In remote areas labour cost are low and locally available material may be used, but the cost of mobilization of machinery is expensive.

### Production benefits

#### Yield increase with FloodWH

Crop	Country	Yield without FloodWH (t/ha)	Yield with FloodWH (t/ha)	Yield gain (%)
Sorghum spate irrigation	Eritrea <sup>1</sup>	0.45	1.2 – 2.1	270 – 470
Fodder grasses spate irrigation	Iran <sup>1</sup>	0.04	0.45	1,060
Rice spreading weirs	Burkina Faso <sup>2</sup>	0.80	2.00	250
Millet spreading weirs	Niger <sup>2</sup>	0.33	0.68	206
Sorghum spreading weirs	Niger <sup>2</sup>	0.36	0.48	133

<sup>1</sup> Van den Ham, 2008; Van Steenberg et al., 2010; Mehari et al, 2011; <sup>2</sup> Nill et al., 2012.

In Spain almond yields were doubled due to irrigation with spate water (J. de Vente in Schwilch et al., 2012; WOCAT, 2012).

The development of a “warping” dam and 16 ha of terraced irrigated land increased the per capita income of 26 households owing 17 ha from a per capita income of US\$ 60 to 276 in two years (Lijiageleng village, Inner Mongolia) (yellowearth.net in Van Steenberg et al., 2011a).

#### Costs of FloodWH per structure (median)

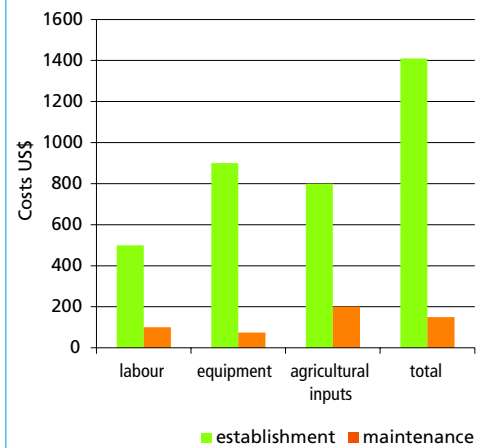

Establishment costs for FloodWH range from US\$ 60 for a spate irrigation system in Eritrea to US\$ 3,600 for a spreading weir in India.

Source: 6 case studies (WOCAT, 2012).

#### Example: Harvesting sediment with “warping” dams, Loess Plateau China

The Loess Plateau has one of the highest erosion rates in the world and the Yellow River itself is named after the color of the suspended fine loess sediment. Under a rehabilitation project which started in the 1990s, 1,272 warping dams – alongside other types of sedimentation control dams (264 key dams, 3,719 check dams), 171,278 ha of terraces and several vegetative measures were developed. The total cost was US\$ 300 million. Yields from warped land in the Loess plateau were estimated to be up to 2–3 times higher compared to terraced land and up to 6–10 times higher compared to sloped land (UNESCO, 2004 as cited in Van Steenberg et al., 2011a). Furthermore soil moisture concentrations upland are up to 80% higher than in the sloping land and a decrease of 51% of sediment transported in the Yellow River were measured in Shaanxi Province (Van Steenberg et al., 2011a).

#### Example: Potential for truffle production in spate irrigation sites

The Loess Plateau covers an area of In spate irrigated areas of Pakistan and South Iran, desert truffles (*Terfezia leonis Tul.*) can be found. These mushrooms form symbiotic relations with sorghum. The potential of systematically collecting this truffle is largely unknown in Pakistan and Iran, even though desert truffles fetch very high prices on international delicacy markets. Thus, the development of truffle collection and marketing is highly promising. There is a need to invest in a market chain for truffles so as to better understand the demand and the requirement for quality control, grading and supply of truffles and probably for other high value products from spate irrigation areas (Nawaz, 2011).

## Impacts

Benefits	Farm level / household level	Community / watershed / landscape level
Production / Economic	<ul style="list-style-type: none"> <li>+++ increased crop production</li> <li>+++ increased area under production</li> <li>++ increased fodder production</li> <li>++ increased farm income</li> <li>+ increased irrigation water availability</li> </ul>	<ul style="list-style-type: none"> <li>+++ allows production of crops in arid regions</li> <li>++ reduced poverty</li> </ul>
Ecological	<ul style="list-style-type: none"> <li>+++ fertility trapping</li> <li>+++ increased soil moisture</li> </ul>	<ul style="list-style-type: none"> <li>+++ groundwater recharge by excess spate water</li> <li>+++ improved discharge of excess water</li> <li>++ FloodWH systems are biodiversity depositories as they collect seeds in a large catchment and depositing them in moist soil</li> </ul>
Socio-cultural		<ul style="list-style-type: none"> <li>+++ maintenance of traditional sophisticated water use agreements</li> <li>+++ increased food security</li> <li>++ increased community institutional strengthening</li> </ul>
Offsite		<ul style="list-style-type: none"> <li>+++ control over floodwater and sedimentation; reduces flooding and gullying downstream</li> </ul>

Importance: +++ high, ++ medium, + low

	Constraints	How to overcome
Production / Economic	downstream users depend on the water supply from upstream	→ well-functioning watershed management is needed
	risk prone due to the high variability of floods and thus production	
	associated with big income fluctuations between good and bad years	→ spatial arrangements of plots, in order to reduce the risk that remote plots receive no floodwater, or reallocation of plots between different users on an annual basis
Ecological	high sediment load causes frequent sedimentation of canals and storage facilities	→ structures should be designed with barriers on the main intake that can be used to regulate water inflows
	very susceptible to seasonal variation in rainfall	→ structures should be designed with barriers on the main intake that can be used to regulate water inflows
	poorly designed secondary and tertiary canals lead to in-field rills and gullies	→ associations to establish standards and norms for design and maintenance
	diversion of floodwater away from downstream ecosystems	→ re-divert excess flows back into original watercourse
	can spread invasive species, e.g. <i>Prosopis juliflora</i>	
Socio-cultural	complex upstream-downstream interactions in terms of water availability leading to conflicts	→ clear land and water use rights and improved watershed planning with allocation of water resources
	high degree of inequity can lead to conflicts because some lands are always served better than others	
	require large amount of maintenance work	

## Adoption and upscaling

### Adoption rate

FloodWH has a millennia-old history in Iran, Pakistan and Yemen. In the Horn of Africa, FloodWH is on the increase. This can be linked to the increasing settlement of the lowland areas which were previously sparsely populated due to the widespread prevalence of malaria. In some areas, FloodWH is also a response to a trend of rivers no longer being perennial due to catchment degradation and climate change. However, in other areas such as in North Africa the area under FloodWH is decreasing mainly due to the construction of small reservoirs alongside many of the ephemeral rivers. The continuation of *jessours* in Tunisia, for example, is not guaranteed, due to the lack of adequate maintenance – as a consequence of emigration and abandonment of agricultural activities in the mountains. On the Loess plateau of China, floodwater harvesting and sediment retention is combined in “staircases” of small dams. Due to political will and national efforts to reduce floods and the sediment loads of the Yellow River these systems are being strongly promoted and spread.

### Enabling environment

**Policy environment:** The topic of FloodWH has been neglected and is almost invisible in programs and policies of governments and civil society.

**Land and water tenure:** To ensure the sustainability of floodwater harvesting systems it is important that land users maintain a high level of ownership of a FloodWH system and keep responsibility for operation and maintenance.

**Scale issues:** Careful understanding of the water balance at the watershed level is necessary to avoid inappropriate design and unintended offsite disadvantages of FloodWH.

**Access to financial services:** Land users consider it relatively expensive to implement FloodWH practices and there is no guarantee of water as this depends on rainfall events. Subsidising earthmoving equipment such as bulldozers has been used as an incentive in several projects. However, one of the disadvantages of such programmes is the fact that traditional water distribution systems are sometimes jeopardized because upstream land users are able to build larger structures with machinery and thus “confiscate” floodwaters that would have reached the schemes below.

**Technical support and capacity development:** In all FloodWH systems land users should be actively involved in the planning, design and execution of the implementation, rehabilitation and improvement works, as well as in any amendment to existing water rights to facilitate the improved allocation of floodwater. Engineers and technical advisors are needed to assist land users in selecting appropriate measures from a range of technically and economically viable options.

**Gender considerations:** Women play important roles in FloodWH systems. Projects therefore have to take this into account and need to be aware of how improvements will change the distribution of work between men and women.

**Good community cohesion:** FloodWH can have two effects on downstream users. One, upstream land users use too much of the floodwater and deprive downstream users from having sufficient water. Secondly, by using the peak flow downstream communities are less exposed to catastrophic effects of floods. In both cases, a high level of cooperation, coordination and planning is required. Additionally, Construction and maintenance requires considerable human and animal labour or the use of tractors and bulldozer and consequently a strong local organization.

**Suitable approaches for implementation:** A combination of regional planning level and local stakeholder involvement.

### Feasibility and planning

FloodWH requires the careful identification of a suitable location for the construction of a diversion structure, which in turn requires careful assessment of expected water inflow, which can usually be based on simple field observation during rainfall events and based on the local knowledge of land users. It is, however, important to consider whether there are activities upstream that possibly affect the water quality and to assess the implications the water harvesting might have downstream. Depending on the country, permission might be required from the water authorities to construct any type of water harvesting structure. The water harvesting structure will require control and some maintenance after each significant runoff event.

### Enabling environment: key factors for adoption

Inputs, material	+++
Incentives, credits	++
Training and education	++
Land / water use rights	+++
Access to markets for inputs and outputs	++
Research	++
Genuine ownership on the part of communities	+++

Importance: +++ high, ++ medium, + low, +/- neutral

### Feasibility and planning: key factors for implementation

Assessing water quantity to be harvested	+++
Assessing water quality	+
Estimating water needs	+
Site assessment	+++
Financial aspects	++
Environmental impact assessment	++
Land / water use rights	+++
Neighbourhood relations	+++
Community involvement	+++
Social and gender aspects	+
Official governmental approval	+++

Importance: +++ high, ++ medium, + low, +/- neutral

### Example: Water use rights are important

In the absence of agreements regarding water rights, conflicts are bound to arise in spate irrigation areas. In one dramatic example from Konso, Ethiopia over 200 persons were killed in a conflict between investors and pastoralists. The water use rights in spate ephemeral rivers are more complex than in perennial systems because the water availability situation differs from year to year as well as within a year. The water rules govern agreed principles on water use: the area entitled for irrigation, the location of the diversion structures, rules regarding breaking them to allow water to flow downstream (Van Steenbergen et al., 2011b).



Planning and upscaling of warping dams in Loess Plateau, China. (HP. Liniger)

## References

- Chunhong, H., Deyi, W., Jayakumar, R. and S. Ajsawa (eds). 2004. *Warping dams: Construction and its Effects on Environment, Economy, and Society in Loess Plateau Region of China*. International Hydrological Programme (IHP), UNESCO Office Beijing & The International Research and Training Center on Erosion and Sedimentation (IRTCES), Beijing. <http://www.irtces.org/pdf-hekou/138198E.pdf>
- Critchley, W. and K. Siegert. 1991. *Water Harvesting. A Manual for the Design and Construction of Water Harvesting Schemes for Plant Production*. FAO, Rome.
- Falkenmark, M., Fox, P., Persson, G. and J. Rockström. 2001. *Water Harvesting for Upgrading of Rainfed Agriculture – Problem Analysis and Research Needs*. Stockholm International Water Institute (SIWI) Report 11, Stockholm.
- GIZ (Deutsche Gesellschaft für Internationale Zusammenarbeit). 2011. Fact sheet: Water Spreading Weirs. GIZ, Eschborn and KfW Entwicklungsbank, Frankfurt. [http://www.solutionsforwater.org/wp-content/uploads/2011/12/Flyer-Nexus\\_waterspreading-weirs.pdf](http://www.solutionsforwater.org/wp-content/uploads/2011/12/Flyer-Nexus_waterspreading-weirs.pdf)
- Graaff de, J. and M. Ouassar. 2002. Water harvesting in Mediterranean zones: an impact assessment and economic evaluation. Proceedings from EU Wahia project final seminar in Lanzarote.
- IFAD (International Fund for Agricultural Development) website. Topics: Spate Irrigation. <http://www.ifad.org/english/water/innowat/topic/irrigation.htm>; accessed December 2012.
- IWMI (International Water Management Institute). 2009. Flexible water storage options: for adaptation to climate change. IWMI, Colombo, Sri Lanka.
- IWSD (Institute of Water and Sanitation Development). 1998. Sourcebook of alternative technologies for freshwater augmentation in Africa. Online Technical Publication Series. UNEP. <http://www.unep.or.jp/ietc/publications/techpublications/techpub-8a/permeable.asp>
- Kiepe, P. 2006. Characterization of three key environments for integrated irrigation-aquaculture and their local names. In Halwart, M. and A.A. van Dam (eds). *Integrated irrigation and aquaculture in West Africa: concepts, practices and potential*: pp. 1–6. FAO, Rome.
- Komakech, H.C., Mul, M.L., van der Zaag, P. and F.B.R. Rwehumbiza. 2011. Water allocation and management in an emerging spate irrigation system in Makanya catchment, Tanzania. *Agricultural Water Management* 98(11):1719-1726.
- Kowsar, S.A. 2011. Floodwater spreading and spate irrigation in Iran. *Spate Irrigation Network*.
- Liniger, H., Mekdaschi Studer, R., Hauert, C. and M. Gurtner. 2011. *Sustainable Land Management in Practice. Guidelines and Best Practices for Sub-Saharan Africa. TerrAfrica, World Overview of Conservation Approaches and Technologies (WOCAT) and Food and Agriculture Organization of the United Nations (FAO)*.
- Mehari, A., Van Steenberg, F. and B. Schultz. 2011. Modernization of Spate Irrigated Agriculture: A New Approach. *Irrigation and Drainage* 60(2):163-173.
- Nawaz, K. 2011. Desert Truffle Mushrooms in Spate Irrigation Areas. *Spate Irrigation Network*.
- Nill, D., Ackermann, K., van den Akker, E., Schöning, A., Wegner, M., van der Schaaf, C. and J. Pieterse. 2012. Water-spreading weirs for development of degraded dry river valleys. Experience from the Sahel. GIZ-Deutsche Gesellschaft für Internationale Zusammenarbeit, Eschborn and KfW Entwicklungsbank, Frankfurt.
- Nill, D., Ackermann, K., van den Akker, E., Schöning, A., Wegner, M., van der Schaaf, C. et J. Pieterse. 2012. Seuils d'épandage pour la valorisation des vallées d'oued dégradées. Expériences du Sahel. GIZ-Deutsche Gesellschaft für Internationale Zusammenarbeit, Eschborn and KfW Entwicklungsbank, Frankfurt.
- Oudra, I. 2011. Spate irrigation in Morocco. *Spate Irrigation Network*.
- Oweis, T.Y., Prinz, D. and A.Y. Hachum, 2012. *Water Harvesting for Agriculture in the Dry Areas*. ICARDA, CRC Press/ Balkema, Leiden, the Netherlands.
- Prinz, D. 2001. *Water Harvesting for Afforestation in Dry Areas*. Paper read at 10th International Conference on Rainwater Catchment Systems, Mannheim, 10-14 Sept. 2001, at Mannheim.
- Schwilch, G., Hessel, R. and S. Verzaandvoort (eds). 2012. *Desire for Greener Land. Options for Sustainable Land Management in Drylands*. Bern, Switzerland, and Wageningen, The Netherlands: University of Bern – CDE, Alterra – Wageningen UR, ISRIC – World Soil Information and CTA – Technical Centre for Agricultural and Rural Cooperation.
- Tesfai, M. and L. Stroosnijder. 2001. The Eritrean spate irrigation system. *Agricultural Water Management* 48(1):51-60.
- Tuinhof, A., van Steenberg, F., Vos, P. and L. Tolck. 2012. Profit from Storage: the Costs and Benefits of Water Buffering. 3R Water Secretariat. Wageningen, The Netherlands.
- Van den Ham, J.P. 2008. *Dodota spate irrigation system Ethiopia: a case study of spate irrigation management and livelihood options*. Irrigation and Water Engineering, Wageningen University.
- Van Steenberg, F., Tuinhof, A. and L. Knoop. 2011a. *Transforming Lives Transforming Landscapes: the Business of Sustainable Water Buffer Management*. 3R Water Secretariat. Wageningen, The Netherlands.
- Van Steenberg, F., Haile, A.M., Alemehayou, T., Alamirew, T. and Y. Geleta. 2011b. Status and Potential of Spate Irrigation in Ethiopia. *Water Resources Management* 25(7):1899-1913.
- Van Steenberg, F., Lawrence, P., Haile A.M., Salman, M. and J-M. Faurès. 2010. *Guidelines on Spate Irrigation*. FAO. Rome, Italy. <http://www.fao.org/docrep/012/i1680e/i1680e.pdf>
- Van Steenberg, F., Verheijen, O., van Aarst, S. and A.M. Haile. 2008. *Spate Irrigation, Livelihood Improvement and Adaptation to Climate Variability and Change*. IFAD/MetaMeta/UNESCO-IHE.
- Waes, van B. and N. Bouman. 2007. *Smart Water Harvesting Solutions: examples of innovative low-cost technologies for rain, fog, runoff water and groundwater*. Water Partnership/ A4A/ Agromisa/ Partners for Water. Netherlands.
- WOCAT (World Overview of Conservation Approaches and Technologies). 2012. WOCAT Database: Technologies. <http://cdewocat.unibe.ch/wocatQT/index.php>.

### Complementary references:

- Anderson, I.M. and M. Burton. 2009. *Best Practices and Guidelines for Water Harvesting and Community Based (Small Scale) Irrigation in the Nile Basin*. Water Harvesting Report. Part I – Best Practices in Water Harvesting. Part II – Guidelines for the implementation of best practices in Water Harvesting. Appendices. Part II – Guidelines for the implementation of best practices in Water Harvesting. Appendix A – List of Reference Material. Kent, Nile Basin Initiative. Efficient Water Use for Agricultural Production Project (EWUAP).
- Anonymous. 2008. *Design manual [for spate irrigation civil works infrastructure]*. Volume 1: Technical Design Criteria. Volume 2: Guidelines for Wadi Diversion and Protection Works. Volume 3: Design Presentations. The European Union's Food Security Programme for Yemen Technical Assistance to the Tihama Development Authority. <http://www.spate-irrigation.org>
- Betifor. 2010. Effets des seuils d'épandage dans la région de Tahoua : cultures sous pluies et contre saison. Campagne 2009/2010. Rapport global provisoire. FICOD. Niger.
- FAO (Food and Agricultural Organization of the UN). 2001. *Water harvesting in Western and Central Africa*. Proceedings of a regional workshop held in Niamey, October, 1999. FAO. Accra, Ghana. <ftp://ftp.fao.org/agl/aglw/docs/waterharvraf.pdf>
- FAO (Food and Agricultural Organization of the UN). 2000. *Manual de captacion y aprovechamiento del agua de lluvia: Experiencias en América Latina. Zonas aridas y semiaridas No. 13*. Santiago, Chile, Organización de las Naciones Unidas para la Agricultura y la Alimentación (FAO), Oficina Regional de la FAO para América Latina y el Caribe. <ftp://ftp.fao.org/docrep/fao/010/ai128s/ai128s00.pdf>



Knoop, L., Sambalino, F. and F. Van Steenberg. 2012. Securing Water and Land in the Tana Basin: a Resource Book for Water Managers and Practitioners. 3R Water Secretariat. Wageningen, The Netherlands.

Lawrence, P. and F. van Steenberg. 2005. Improving Community Spate Irrigation. Report OD 154. HR Wallingford Limited and DFID.

Liniger, H. and W. Critchley (eds). 2007. Where the land is greener – case studies and analysis of soil and water conservation initiatives worldwide. World Overview of Conservation Approaches and Technologies (WOCAT).

Picard, J. not dated. Fact sheet: Water Spreading Weirs: methods and tools. GIZ, PDRD-PRODABO. Chad.

Ratsey, J. 2011. Engineering Manual for Spate Irrigation. Technical Assistance for the Support to the Agricultural Sector / Food Security Programme in Eritrea. Wiltshire, Landell Mills Limited. [http://www.spate-irrigation.org/wordpress/wp-content/uploads/Engineering\\_Manual\\_Spate\\_Irrigation\\_Small.pdf](http://www.spate-irrigation.org/wordpress/wp-content/uploads/Engineering_Manual_Spate_Irrigation_Small.pdf)

Rochette, R.M. (ed). 1989. Le sahel en lutte contre la desertification: leçons d'expériences. Comité Inter-Etats de Lutte contre la Sécheresse au Sahel (CILSS). Margraf. Weikersheim.

Roose, E., Sabir, M. and A. Laouina (eds). 2010. Gestion durable des eaux et des sols au Maroc : valorisation des techniques traditionnelles méditerranéennes. Institut de recherche pour le développement (IRD). Marseille, France. <http://www.documentation.ird.fr/hor/fdi:010054917>

Spate Irrigation Network. Training materials from Yemen, Ethiopia and Pakistan. Spate Irrigation Network. <http://www.spate-irrigation.org/resource-documents/training-material>

Taamallah, H. (ed). 2010. Gestion durable des terres en Tunisie – Bonnes pratiques agricoles. Land Degradation Assessment in Drylands (FAO-LADA), World Overview of Conservation Approaches and Technologies(WOCAT) and Institut des Régions Arides (IRA, Médénine).

Tekle, H.K. 2012. Community Spate Irrigation in Raya Valley: the Case of Three Spate Irrigation Systems. LAP LAMBERT Academic Publishing.

World Bank Institute (WBI). 2010. Rehabilitating a Degraded Watershed: a Case Study from China's Loess Plateau. Case-based learning. Learning series on sustainable water and land management. World Bank. <http://wbi.worldbank.org/wbi/Data/wbi/wbicms/files/drupal-acquia/wbi/0928313-03-31-10.pdf>

#### Audio-visual media:

Spate Irrigation Network. 2012. What is spate irrigation? Video. Produced by: The Water Channel. Language: English. [http://www.thewaterchannel.tv/index.php?option=com\\_hwdvideoshare&task=viewvideo&Itemid=4&video\\_id=1216](http://www.thewaterchannel.tv/index.php?option=com_hwdvideoshare&task=viewvideo&Itemid=4&video_id=1216)

Spate Irrigation Network. 2011. Climate Variability and Food Security. Video. Produced by: The Water Channel. Language: English. [http://www.thewaterchannel.tv/index.php?option=com\\_hwdvideoshare&Itemid=4&task=viewvideo&video\\_id=1122](http://www.thewaterchannel.tv/index.php?option=com_hwdvideoshare&Itemid=4&task=viewvideo&video_id=1122)

Spate Irrigation Network. 2011. Water Rights in spate irrigation. Video. Produced by: The Water Channel. Language: English. <http://www.thewaterchannel.tv/en/videos/categories/viewvideo/1129/agriculture/water-rights-in-spate-irrigation>

Spate Irrigation Engineering. 2012. Lessons from Past Interventions. Video. Produced by: The Water Channel. Language: English. [http://www.thewaterchannel.tv/index.php?option=com\\_hwdvideoshare&Itemid=4&task=viewvideo&video\\_id=1249](http://www.thewaterchannel.tv/index.php?option=com_hwdvideoshare&Itemid=4&task=viewvideo&video_id=1249)

More videos about floodwater harvesting can be found on <http://www.thewaterchannel.tv/>

#### Networks:

MetaMeta Research. AJ 's-Hertogenbosch, The Netherlands. Focus: Global. <http://www.metameta.nl/>

Spate Irrigation Network. Secretariat: MetaMeta Research and UNESCO-IHE, The Netherlands. Focus: Global. <http://www.spate-irrigation.org/>

Know With The Flow. Resource website on developing water related training and communication material. MetaMeta Communications, the Netherlands and Cap-Net, South Africa. <http://www.knowwiththeflow.org/>

World Overview of Conservation Approaches and Technologies (WOCAT). Secretariat: CDE, University of Bern. Focus: Global. <https://www.wocat.net/>

3R initiative. Secretariat: Aqua for all, Den Haag, The Netherlands. <http://www.bebuffered.com>

#### Recurrent events:

Annual Short Course on Spate Irrigation at UNESCO-IHE. <http://www.unesco-ihe.org/Education/Non-degree-Programmes/Short-courses/Spate-Irrigation-and-Water-Management-under-Drought-and-Water-Scarcity>

Double Degree MSc Course on Spate Irrigation between Haramaya University and UNESCO-IHE

The American Rainwater Catchment Systems Association's (ARCSA) annual conference on rainwater

#### Selected WOCAT case studies:

Eritrea: Spate irrigation. QTERI001. [http://cdewocat.unibe.ch/wocatQT/qt\\_summary.php?qt\\_id=39](http://cdewocat.unibe.ch/wocatQT/qt_summary.php?qt_id=39)

Ethiopia: Runoff and floodwater farming. QTETH37. [http://cdewocat.unibe.ch/wocatQT/qt\\_summary.php?qt\\_id=428](http://cdewocat.unibe.ch/wocatQT/qt_summary.php?qt_id=428)

Spain: Water harvesting from concentrated runoff for irrigation purposes. QTSPO4. [http://cdewocat.unibe.ch/wocatQT/qt\\_summary.php?qt\\_id=549](http://cdewocat.unibe.ch/wocatQT/qt_summary.php?qt_id=549)

Chad: Water-spreading weirs for the development of degraded dry river valleys. QTCHA001. [http://cdewocat.unibe.ch/wocatQT/qt\\_summary.php?lang=english&qt\\_id=647](http://cdewocat.unibe.ch/wocatQT/qt_summary.php?lang=english&qt_id=647)

Tunisia: Jessour. QTTUN09. [http://cdewocat.unibe.ch/wocatQT/qt\\_summary.php?lang=english&qt\\_id=239](http://cdewocat.unibe.ch/wocatQT/qt_summary.php?lang=english&qt_id=239)

Tunisia: Tabia. QTTUN12. [http://cdewocat.unibe.ch/wocatQT/qt\\_summary.php?qt\\_id=236](http://cdewocat.unibe.ch/wocatQT/qt_summary.php?qt_id=236)



## Spate irrigation

Eritrea

**Spate irrigation is a traditional water diversion and spreading technology.**

Spate irrigation has a long history in Eritrea and still forms the livelihood base for rural communities in arid lowlands of the country. It is a traditional water diversion and spreading technique under which seasonal floods of short duration – springing from the rainfall-rich highlands – are diverted from ephemeral rivers (*wadis*) to irrigate cascades of leveled and banded fields in the coastal plains.

The diversion structures include the following elements: (1) the '*agim*', a temporary 3-4 m high river diversion structure on the low-flow side of the *wadi*, made from brushwood, tree trunks, earth, stones and / or boulders, erected to divert a large part of the flow during a spate flow to adjacent agricultural fields; (2) a primary, and several secondary distribution canals; unlined, bordered by earthen embankments; convey and spread the floodwater to the irrigable fields; (3) the fields, rectangular shaped, of about 1–2 ha, separated by earthen bunds. Floodwater is distributed from field to field: when a field is completely flooded (to a depth of about 0.5 m), water is conveyed to the immediate downstream field by breaching one of the bunds. This process continues until all the water is used up. Arable fields need to be flooded several times.

The water soaks deep into the soil profile (up to 2.4 m) and provides moisture sufficient for two or even three harvests: crop growth is entirely dependent on the residual soil moisture. The main crop grown is sorghum; maize is the next most important. Sedimentation is as important as water management: With each flood, soil is built up by depositing rich sediment on the fields. Due to the force of the floods, the diversion structures are frequently damaged and / or washed away.

Reconstruction and maintenance are labour-intensive and require collective community action. Elaborate local regulations, organisation and cooperation at the community level are prerequisites for successful management of spate irrigation systems.

**Above left:** Social organisation and community action are prerequisites for spate irrigation systems: construction of an *agim* in a dry river bed. (Photo: IFAD)

**Above right:** Fertile sediments and spate irrigation result in high sorghum yields. (Photo: IFAD)

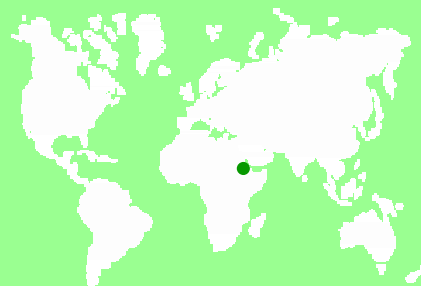

**Location:** Wadi Laba

**Region:** Sheeb area, Eastern lowlands

**Technology area:** 160 km<sup>2</sup>

**Conservation measure:** structural

**Stage of intervention:** prevention

**Origin:** developed through land user's initiative, traditional (>50 years ago)

**Land use:** cropland

**Climate:** arid, tropics

**WOCAT database reference:** QT ERI001en on [cdewocat.unibe.ch/wocatQT](http://cdewocat.unibe.ch/wocatQT)

**Related approach:** not documented



**Compiled by:** Haile Abraham Mehari, UNESCO-IHE Institute for Water Education, Delft, Netherlands

**Date:** 01st Jan 1970, updated 2001

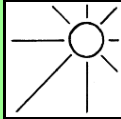

## Classification

**Land use problems:** High- intensity rainfall events are common and cause heavy runoff, flooding and soil erosion.

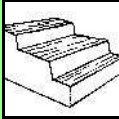
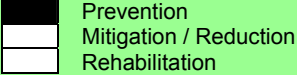
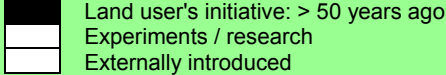
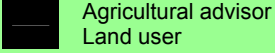
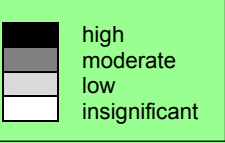
Land use	Climate	Degradation	Conservation measure
 annual cropping (post / flooding)	 arid, tropics	 soil erosion by water: loss of topsoil/ surface erosion	 structural: graded ditches/ waterways (to drain and convey water)
Stage of intervention	Origin	Level of technical knowledge	
			
<p><b>Main causes of land degradation:</b>            Direct causes - natural: heavy extreme rainfall, change of seasonal rainfall            Indirect causes: poverty / wealth</p>			
<p><b>Main technical functions:</b>            - control of concentrated runoff: drain / divert            - increase of infiltration            - water harvesting / increase water supply            - water spreading</p>		<p><b>Secondary technical functions:</b>            none</p>	
			

## Environment

### Natural Environment

#### Average annual rainfall (mm)

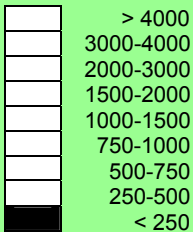

#### Altitude (m a.s.l.)

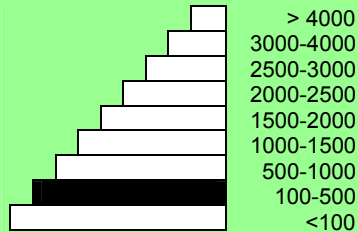

#### Landform

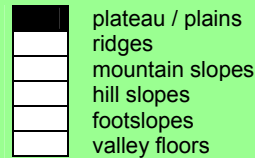

#### Slope (%)

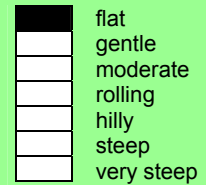

#### Soil depth (cm)

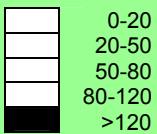

**Growing season(s):** June until September  
**Soil texture:** medium (loam)  
**Soil fertility:** very high  
**Topsoil organic matter:** no data  
**Soil drainage/infiltration:** good

**Soil water storage capacity:** no data  
**Ground water table:** no data  
**Availability of surface water:** excess (e.g. flood)  
**Water quality:** no data  
**Biodiversity:** no data

**Tolerant of climatic extremes:** temperature increase, seasonal rainfall increase, seasonal rainfall decrease, heavy rainfall events (intensities and amount), wind storms / dust storms, floods, droughts / dry spells

**Sensitive to climatic extremes:** The technology is tolerant to climatic extremes (adapted to unpredictable heavy floods)

## Human Environment

### Cropland per household (ha)

no data

	<0.5
	0.5-1
	1-2
	2-5
	5-15
	15-50
	50-100
	100-500
	500-1,000
	1,000-10,000
	>10,000

**Land user:** groups / community, small scale land users, disadvantaged land users

**Population density:** low

**Annual population growth:** 2- 3%

**Land ownership:** state

**Land use rights:** individual

**Water use rights:** no data

**Relative level of wealth:** poor - very poor

**Importance of off-farm income:** is becoming increasingly important.

**Access to service and infrastructure:** no data

**Market orientation:** subsistence (self-supply)

**Mechanization:** manual labour, animal traction

**Livestock grazing on crop residues:** yes

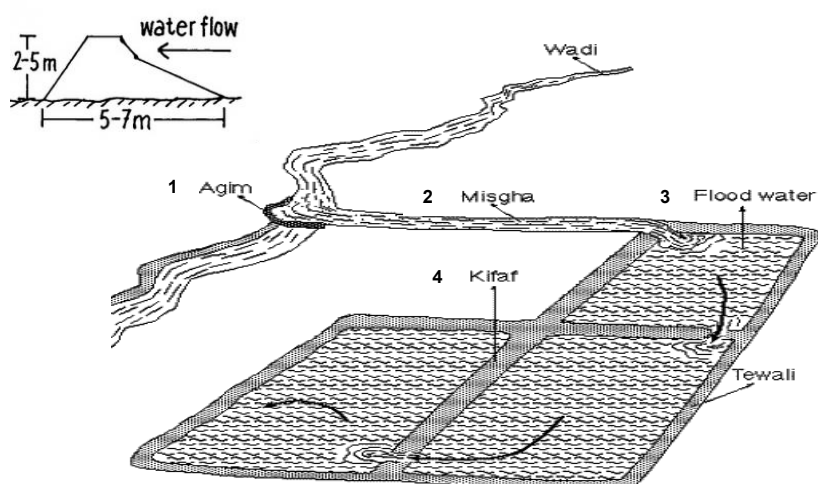

### Technical drawing

Cross section of an *agim* (top left); Components of a traditional spate irrigation system: (1) *agim*; (2) *misgha* (main distribution canal); (3) irrigated fields; (4) earthen embankments. Arrows indicate the water flow (Photo: adapted from Tesfai and Stroosnijder)

## Implementation activities, inputs and costs

### Establishment activities

1. Construction of diversion structure (*agim*)
2. Construction of main distribution canal
3. Construction of secondary distribution canals
4. Levelling of fields
5. Establish embankments around fields and within fields

### Establishment inputs and costs per ha

Inputs	Costs (US\$)	% met by land user
Labour (12 persons days)	no data	
Equipment - 4 camel-days, 10 pairs of ox-days, scouring and tillage implements	no data	
Construction material - tree trunks, brush wood, stones, boulders, earth	no data	
<b>TOTAL</b>	<b>60</b>	<b>100</b>

### Maintenance/recurrent activities

1. Reconstruction / repair of diversion structures (2-4 times / year; collective community action)
2. Annual desilting / repair of distribution canals
3. Annual raising of bund heights due to silting up of fields
4. Flood fields (community action, during highland rainy season: July-September). Most likely a field receives 3 irrigation turns, on a bi-weekly interval between any 2 turns
5. Soil tillage (15 cm deep; using oxen-drawn plough) to break capillary uplift of soil water and to create evaporation barrier
6. Sowing (10 days after last flooding; Mid-September)

### Maintenance/recurrent inputs and costs per ha per year

Inputs	Costs (US\$)	% met by land user
Labour	no data	
Equipment - camels, oxen, scouring and tillage implements	no data	
<b>TOTAL</b>	<b>48-96</b>	<b>100</b>

**Remarks:** Data on labour inputs for construction/maintenance of canals and field bunds are not included, therefore not included in the tables above. Costs for *agim* reconstruction are 40% of establishment. Total maintenance costs depend on the number of reconstructions during normal spate season (2-4 times). The yearly cost (establishment and maintenance) reaches US\$ 60-156. The costs were calculated per unit = 10 m long *agim* (1 m high, 3 m wide), constructed with mixed material (stones, earth, brushwood)

## Assessment

### Impacts of the Technology

Production and socio-economic benefits	Production and socio-economic disadvantages
<p>+++ increased crop yield</p> <p>+++ increased fodder production</p> <p>+++ increased water availability / quality</p> <p>+++ increased farm income</p> <p>+++ increased production area</p>	none
Socio-cultural benefits	Socio-cultural disadvantages
<p>+++ community institution strengthening</p> <p>+++ improved food security / self sufficiency</p>	none
Ecological benefits	Ecological disadvantages
<p>+++ improved harvesting / collection of water</p> <p>+++ increased soil moisture</p> <p>+++ increased nutrient cycling recharge</p>	none
Off-site benefits	Off-site disadvantages
none	none
Contribution to human well-being/livelihoods	
no data	

+++ : high, ++ : medium, + : low

Benefits/costs according to land user	Benefits compared with costs	
	short-term:	long-term:
	<b>Establishment</b>	no data
<b>Maintenance/recurrent</b>	no data	no data

**Acceptance/adoption:** Spate irrigation is an indigenous technology, originally introduced from Yemen. Spontaneous spread takes place throughout the lowlands. Current spate irrigation area in Eritrea is 16,000 ha. Potential area is estimated at 60,000– 90,000 ha.

## Concluding statements

Strengths and → how to sustain/improve	Weaknesses and → how to overcome
<p>Spate irrigation forms the livelihood base for rural communities in arid lowlands of the country.</p> <hr/> <p>The technology takes advantage of floodwater that is otherwise lost because of the erratic character and short duration of flow → find optimal location for the water harvesting structures using a modelling approach.</p>	<p>Highly labour-intensive and time consuming maintenance; water diversion structures are frequently breached / washed away by heavy floods; canals are obstructed through deposition of boulders, gravel and coarse sediments → yearly repair / reconstruction is required.</p> <hr/> <p>Great demand for wood: huge numbers of trees are annually needed for (re-)constructing diversion structures.</p> <hr/> <p>Irrigation efficiency is only about 20% because of the difficulty of controlling large amounts of water in a short period of time (and often at night) and because water is lost by percolation, seepage and evaporation → 1) withstand the force of heavy floods and divert the water effectively 2) eliminate the need to cut trees, (3) reduce human and animal labour inputs, (4) increase productivity; lining the main canals with cements would reduce water loss by percolation and seepage. Proper leveling of basin fields helps to distribute the floodwater uniformly.</p>

**Key reference(s):** Abraham Mehari H, Van Steenberg F, Verheijen O, Van Aarst S: Spate Irrigation, Livelihood Improvement and Adaptation to Climate Variability and Change; / Mehretab Tesfai Stroosnijder L: The Eritrean spate irrigation system / Abraham Mehari, Depeweg, H, Schultz B (2005): Hydraulic Performance Evaluation of The Wadi Laba Spate Irrigation System in Eritrea, in Irrigation and Drainage. 54: 389–406; online: Wiley InterScience (www.interscience.wiley.com). / Berhane Haile G, Van Steenberg F: Agricultural Water Management in Ephemeral Rivers: Community Management in Spate Irrigation in Eritrea; in African Water Journal / Berhane Haile G: Community Spate Irrigation in Bada, Eritrea / Mehretab Tesfai, Stroosnijder L (2000): The Eritrean spate irrigation system; on-line: linkinghub.elsevier.com/retrieve/pii/S0378377400001153

**Contact person(s):** Abraham Mehari Haile, UNESCO-IHE Institute for Water Education, Delft, The Netherlands; A.MehariHaile@unesco-ihe.org



## Runoff and floodwater farming

Ethiopia - *Korbe* (*Oromifa*)

**Runoff/flood farming locally known as Korbe is a practice that involves diversion of water from different sources for growing vegetables, fruit trees and crops of high value on a land prepared known as Korbe.**

Runoff and floodwater farming is a traditionally practiced water harvesting system which helps overcome problems of soil moisture and crop failure in a hot, dry area with erratic rainfall and shallow, highly erodible soils: Flood water and runoff from ephemeral rivers, roads and hillsides is captured through temporary stone and earth embankments. A system of hand dug canals – consisting of a main diversion canal and secondary / tertiary canals – conveys and distributes the captured water to the cultivated fields in naturally flat or leveled areas. The total length of the canal system is 200 – 2000 m. The harvested water is used for growing high value crops, vegetables and fruit trees. Irrigated fields are divided into rectangular basins bordered by ridges to maximize water storage and minimize erosion risk.

Runoff and floodwater management requires preparedness for immediate action by the farmers: When a flood is expected in the ephemeral river, farmers rush to the diversion site and start erecting the embankment across the bed of the stream. Similarly, each farmer starts to maintain the canal which leads water to his field. A schedule defines the date and time each farmer is allocated his turn to irrigate. When the water reaches the field, it is spread either through flooding or distributed in furrows which are opened and closed using a local tool.

The ratio between catchment area and production area is 10:1 – 100:1 or greater. While the diversion canals / ditches and basins for tree planting are permanent structures, basins for annual crops are seasonal. Soil fertility is improved by additional measures such as composting and mulching. Maintenance, including repairs to breaks along the canal and water conveying ditches, is needed every season before the onset of rains.

**Above left:** Principal floodwater canal diverting water towards the field. (Photo: Daniel Danano)

**Above right:** Crop fields prepared for flooding. (Photo: Daniel Danano)

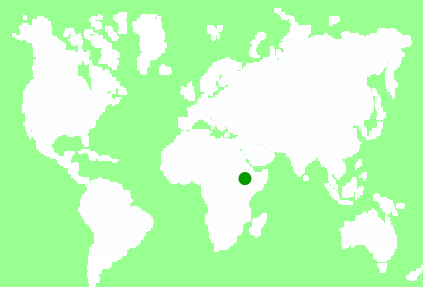

**Location:** Dire Dawa

**Region:** Harea, Delo Belina, Bishan Bahe

**Technology area:** 10 - 100 km<sup>2</sup>

**Conservation measure:** structural and agronomic

**Stage of intervention:** mitigation

**Origin:** developed through land user's initiative, traditional (>50 years ago)

**Land use:** cropland

**Climate:** semi-arid, subtropics

**WOCAT database reference:** QT ETH037en on [cdewocat.unibe.ch/wocatQT](http://cdewocat.unibe.ch/wocatQT)

**Related approach:** not documented











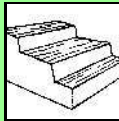
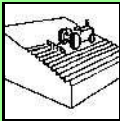

**Compiled by:** Daniel Danano, Ministry of Agriculture and Rural Development, Ethiopia

**Date:** 30th May 2011



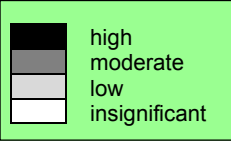

## Classification

**Land use problems:** Low fertility of soils and the associated decline in production and erratic rains Overgrazing on hillslopes causing severe degradation, human and livestock interferences in area enclosures, use of crop varieties of low production.

<b>Land use</b>  tree and shrub cropping (rainfed)	 annual cropping (rainfed)	<b>Climate</b>  semi-arid, subtropics	<b>Degradation</b>  chemical soil deterioration: fertility decline/ reduced organic matter content	<b>Conservation measure</b>   structural: graded ditches/ waterways agronomic: composting and mulching	
<b>Stage of intervention</b>  Prevention  Mitigation / Reduction  Rehabilitation		<b>Origin</b>  Land user's initiative: > 50 years ago  Experiments / research  Externally introduced		<b>Level of technical knowledge</b>  Agricultural advisor  Land user	
<b>Main causes of land degradation:</b> Direct causes - natural: heavy extreme rainfall, change of seasonal rainfall			<b>Main technical functions:</b> - reduction of slope angle - water harvesting / increase water supply		
			<b>Secondary technical functions:</b> - control of concentrated runoff: retain / trap - increase of infiltration - water spreading		

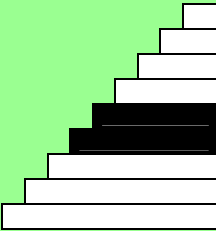
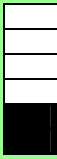
## Environment

<b>Natural Environment</b>			
<b>Average annual rainfall (mm)</b>  <ul style="list-style-type: none"> <li>&gt; 4000</li> <li>3000-4000</li> <li>2000-3000</li> <li>1500-2000</li> <li>1000-1500</li> <li>750-1000</li> <li>500-750</li> <li>250-500</li> <li>&lt; 250</li> </ul>	<b>Altitude (m a.s.l.)</b>  <ul style="list-style-type: none"> <li>&gt; 4000</li> <li>3000-4000</li> <li>2500-3000</li> <li>2000-2500</li> <li>1500-2000</li> <li>1000-1500</li> <li>500-1000</li> <li>100-500</li> <li>&lt;100</li> </ul>	<b>Landform</b>  <ul style="list-style-type: none"> <li>plateau / plains</li> <li>ridges</li> <li>mountain slopes</li> <li>hill slopes</li> <li>footslopes</li> <li>valley floors</li> </ul>	<b>Slope (%)</b>  <ul style="list-style-type: none"> <li>flat</li> <li>gentle</li> <li>moderate</li> <li>rolling</li> <li>hilly</li> <li>steep</li> <li>very steep</li> </ul>
<b>Soil depth (cm)</b>  <ul style="list-style-type: none"> <li>0-20</li> <li>20-50</li> <li>50-80</li> <li>80-120</li> <li>&gt;120</li> </ul>	<b>Growing season(s):</b> 210 days (April until November) <b>Soil texture:</b> coarse / light (sandy) <b>Soil fertility:</b> low <b>Topsoil organic matter:</b> low (<1%) <b>Soil drainage/infiltration:</b> good		<b>Soil water storage capacity:</b> low <b>Ground water table:</b> no data <b>Availability of surface water:</b> no data <b>Water quality:</b> no data <b>Biodiversity:</b> no data
<b>Tolerant of climatic extremes:</b> increased tolerance to drought and seasonal variations <b>Sensitive to climatic extremes:</b> extreme flood events <b>If sensitive, what modifications were made / are possible:</b> no data			

## Human Environment

### Cropland per household (ha)

	<0.5
	0.5-1
	1-2
	2-5
	5-15
	15-50
	50-100
	100-500
	500-1,000
	1,000-10,000
	>10,000

**Land user:** better-off small-scale farmers  
**Population density:** 150 persons/km<sup>2</sup>  
**Annual population growth:** 2-3%  
**Land ownership:** state  
**Land use rights:** private  
**Water use rights:** no data  
**Relative level of wealth:** average

**Importance of off-farm income:** less than 10% of all income: no big difference is observed between the average/better off and the poor in this regard.  
**Access to service and infrastructure:** no data  
**Market orientation:** mainly commercial, partly mixed (90% of vegetables and fruits are sold)  
**Mechanization:** manual labour  
**Livestock grazing on crop residues:** no data



### Technical drawing

Crop fields prepared for flooding. The basins allow controlled flooding of the fields. (Photo: Daniel Danano)

## Implementation activities, inputs and costs

### Establishment activities

1. Construction of diversion canals with lateral embankments, from runoff source to the fields. Embankments are stabilised with stones – if possible (hand dug during dry season).
2. Seed bed preparation before the water is diverted to the fields: construction of rectangular basins separated by small bunds (0.3 m high; 0.3 m wide).
3. Watering the field for better seed germination. The field is watered before the seeds are planted otherwise germination will be affected.

Main canal: 3-4 m wide, 0.5-0.75 m high  
 Secondary canal: 2-3 m wide, 0.5 m high  
 Tertiary canal: 0.5-1 m wide

### Establishment inputs and costs per ha

Inputs	Costs (US\$)	% met by land user
Labour (295 person-days)	253	100
Equipment - tools	24	100
Agricultural	106	100
<b>TOTAL</b>	<b>383</b>	<b>100</b>

### Maintenance/recurrent activities

1. Runoff management. This is essentially the activity of spreading water to the field which includes cleaning the canals for directing water to the field.
2. Seed bed preparation (reconstruction of basins is done every season, before the water is diverted to the field).
3. Regular maintenance / repairing of runoff diversion canals: scouring, removing sediment / silt, repairing breaks in the embankment.

### Maintenance/recurrent inputs and costs per ha per year

Inputs	Costs (US\$)	% met by land user
Labour (525 person-days)	450	100
Equipment - tools	64	100
Agricultural - seeds	300	100
<b>TOTAL</b>	<b>814</b>	<b>100</b>

**Remarks:** Establishment costs include the construction of diversion ditch, construction of blocks (irrigation basins); seeds and seedlings. Maintenance costs include the reconstruction of blocks / seedbed preparation; seeds and seedlings; weeding and cultivation; irrigation; harvest. Costs have been calculated assuming that 0.5 ha of the land is planted by fruit trees and 0.5 ha planted with vegetables. Daily wage cost of hired labor to implement SLM is 0.85 US\$. All costs are met by the land users themselves.



## Assessment

Impacts of the Technology	
<b>Production and socio-economic benefits</b> +++ increased crop yield +++ increased farm income +++ fodder production/quality increase +++ increased wood production	<b>Production and socio-economic disadvantages</b> none
<b>Socio-cultural benefits</b> +++ improved conservation / erosion knowledge +++ community institution strengthening	<b>Socio-cultural disadvantages</b> none
<b>Ecological benefits</b> +++ increased soil moisture +++ reduced soil loss +++ increase in soil fertility +++ increased infiltration +++ reduced runoff	<b>Ecological disadvantages</b> none
<b>Off-site benefits</b> +++ reduced downstream flooding +++ increased stream flow in dry season +++ reduced downstream siltation	<b>Off-site disadvantages</b> none
<b>Contribution to human well-being/livelihoods</b> No data	

+++ : high, ++ : medium, + : low

Benefits/costs according to land user	Benefits compared with costs	
	short-term:	long-term:
	<b>Establishment</b>	positive
<b>Maintenance/recurrent</b>	very positive	very positive

Net benefits are positive from the beginning due to rapid production increase.

**Acceptance/adoption:** 100% of land users that have applied the technology have done it wholly voluntarily, without any incentives except technical guidance. There is enough local skill and support to expand the technology.

## Concluding statements

Strengths and → how to sustain/improve	Weaknesses and → how to overcome
Enhancing of the rainfall multiplier effect → frequent maintenance of the diversion ditches and field canals, blocks.	Increased labour constraints: construction of diversion ditches, preparation of irrigation basin and spreading the runoff water and regular maintenance / reconstruction of structures is very labour intensive → providing improved farm tools could improve efficiency of operation, organising farmers in groups for sharing labor would curtail labor problems; Placing permanent structures at the diversion head (concrete) and paving ditches to improve channel stability would reduce maintenance activities.
Good seed bed preparation enhancing germination and → leveling of land to be further continued and enhanced.	
Reduction of water losses by means of mulching → effective mulching to reduce evapotranspiration should be strengthened.	Social inequity: mainly better-off farmers apply the technology (due to high costs) → providing credit solves financial problems and facilitating market would motivate land users to get more engaged in the business.
Facilitate formation of cooperatives and group work → more cooperatives established and strengthen their management systems.	
Increase the income of farmers (vegetables + fruits) → more diversified fruit and vegetable varieties to be introduced.	
Increase in productivity of land → access to credit services.	Loss of land (through conservation structures → is outweighed by the high production benefits.

**Key reference(s):** Danano, D (2010) Sustainable Land Management Technologies and Approaches in Ethiopia. ([https://www.wocat.net/fileadmin/user\\_upload/Ethiocat\\_book.pdf](https://www.wocat.net/fileadmin/user_upload/Ethiocat_book.pdf))

**Contact person(s):** Daniel Danano, Ministry of Agriculture and Rural Development, Addis Ababa, Ethiopia; ethiocat@ethionet.et



# Water harvesting from concentrated runoff for irrigation purposes

Spain - Boqueras (Spanish)

## Water harvesting from intermittent streams to nearby fields and terraces during runoff events.

Water shortage is one of the most limiting factors for sustainable agriculture in large parts of SE-Spain. Part of the solution of this problem may come from the restoration of traditional water harvesting structures. Many of these structures were widely used in SE-Spain already during Arab and Roman times, and are also widespread in N-Africa and the Middle East. However, nowadays in Spain many of them are abandoned and forgotten. Here, we describe the technology of a small earthen- or stone- built bund that diverts flood water from intermittent streams towards cultivated fields with almond orchards and/or cereals. The diverted water will temporarily flood the fields and provide the crops with water. Depending on the slope gradient and the amount of water to be harvested, the fields are organised as single terraces, or as a staircase of terraces. On fields with gradients above ~3%, terraces are necessary to reduce the gradient and to retain the floodwater as long as possible. Water is diverted from one terrace to the next through small spillways in the terrace. The spillways can best be fortified with stones to prevent bank gully formation. The extra input of surface water can double the almond yield. The use of these water harvesting structures is only possible under certain environmental and topographic conditions. The cultivated fields should be at a relatively short distance from an intermittent stream (<~50m), and the stream should have a sufficiently large upstream contributing area to provide significant amounts of runoff water during rainfall events. With these systems, water can be harvested up to 8 times per year, mostly in spring and autumn during high intensity rainfall events. A well designed Boquera system may provide up to 550 mm of additional water, in areas with an average annual rainfall of 300 mm.

The goal of this technology is to increase crop yield. In addition, these structures help to reduce the intensity of floods and reduce the damage caused by them by reducing runoff volume in intermittent streams.

Water harvesting requires the identification of a suitable location for the construction of a diversion structure. This requires assessment of expected water inflow, which can usually be based on simple field observation during rainfall events and based on local knowledge of land users. It is, however, important to consider whether there are activities upstream that possibly affect the water quality (e.g. farm animals) and to assess the implications the water harvesting might have downstream. Permission is required from the water authorities to construct any type of water harvesting structure. Such structures are built by creating a small bund (<1m height) in the centre or to the side of a stream. Depending on the size, the bund can be built with a shovel or a tractor. The water harvesting structure will require control and some maintenance after each important runoff event. When strengthened with concrete, maintenance will be reduced to approximately once every 5 years.

Soils are mostly of shallow to medium depth (20-60 cm), and slopes are gentle to moderate (5-15%). The climate is semi-arid with a mean annual rainfall around 300 mm. Droughts, centred in summer commonly last for more than 4-5 months. Annual potential evapotranspiration rates larger than 1000 mm are common.

**Above left:** Water flowing through a traditional channel system (*acequia*) towards almond terraces. (Photo: Joris de Vente)  
**Above right:** Aerial view of a traditional water harvesting system (*boquera*) in SE-Spain. (Photo: Google)

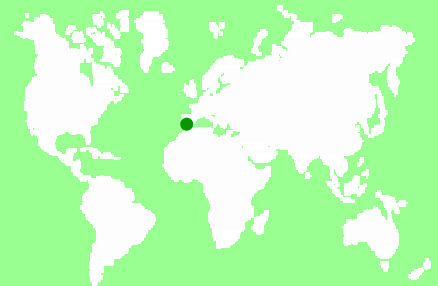





**Location:** Guadalentin catchment  
**Region:** Murcia  
**Technology area:** < 0.1 km<sup>2</sup>  
**Conservation measure:** structural  
**Stage of intervention:** prevention of land degradation, mitigation / reduction of land degradation  
**Origin:** developed through land user's initiative, traditional (>50 years ago)  
**Land use:** cropland  
**Climate:** semi-arid, subtropics  
**WOCAT database reference:** QT SPA004en on [cdewocat.unibe.ch/wocatQT](http://cdewocat.unibe.ch/wocatQT)  
**Related approach:** not documented  
**Compiled by:** Joris de Vente, EEZA-CSIC, Spain  
**Date:** 12th Jun 2008, updated 1st Jul 2011



## Classification

**Land use problems:** There is a lack of water for irrigation of crops limiting the crop types that can be planted as well as the crop yield of dryland farming. A lack of water availability seriously limits the production potential of the soil and results in a low vegetation/crop cover. The relatively high soil erosion rates cause various off-site related problems (i.e. flooding, reservoir siltation) and on-site problems (i.e. gully formation and loss of soil depth).

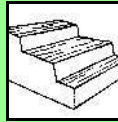
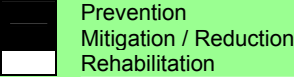
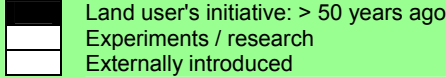
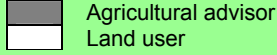
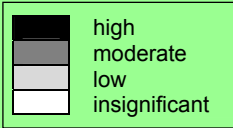
<b>Land use</b>  tree and shrub cropping (rainfed)	 agroforestry	<b>Climate</b>  semi-arid, subtropics	<b>Degradation</b>  water degradation: aridification	<b>Conservation measure</b>  structural: bunds and bench terraces (slope of terrace bed <6%)
<b>Stage of intervention</b> 		<b>Origin</b> 		<b>Level of technical knowledge</b> 
<b>Main causes of land degradation:</b> Direct causes - natural: droughts		<b>Main technical functions:</b> - water harvesting / increase water supply - control of concentrated runoff: retain / trap - control of concentrated runoff: impede / retard - control of concentrated runoff: drain / divert - increase of infiltration		<b>Secondary technical functions:</b> - water spreading 

## Environment

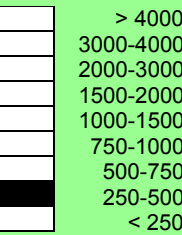
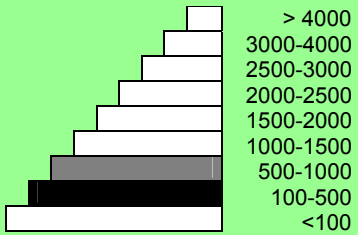
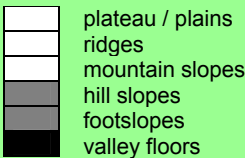
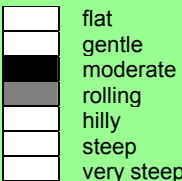
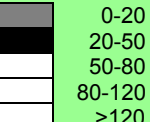
<b>Natural Environment</b>			
<b>Average annual rainfall (mm)</b> 	<b>Altitude (m a.s.l.)</b> 	<b>Landform</b> 	<b>Slope (%)</b> 
<b>Soil depth (cm)</b> 	<b>Growing season(s):</b> 220 days (November until June) <b>Soil texture:</b> medium (loam) <b>Soil fertility:</b> low <b>Topsoil organic matter:</b> medium (1-3%) <b>Soil drainage/infiltration:</b> poor (e.g. sealing /crusting)		<b>Soil water storage capacity:</b> medium <b>Ground water table:</b> 5 - 50 m <b>Availability of surface water:</b> poor / none <b>Water quality:</b> for agricultural use only <b>Biodiversity:</b> low
<b>Tolerant of climatic extremes:</b> temperature increase, seasonal rainfall increase, wind storms / dust storms, droughts / dry spells, decreasing length of growing period <b>Sensitive to climatic extremes:</b> seasonal rainfall decrease, heavy rainfall events (intensities and amount), floods <b>If sensitive, what modifications were made / are possible:</b> The crop type is sensitive to changes in water availability under the semi-arid conditions.			

## Human Environment

### Cropland per household (ha)

	<0.5
	0.5-1
	1-2
	2-5
	5-15
	15-50
	50-100
	100-500
	500-1,000
	1,000-10,000
	>10,000

**Land user:** individual and common small scale land users, mainly men  
**Population density:** 10-50 persons/km<sup>2</sup>  
**Annual population growth:** < 0.5%  
**Land ownership:** individual, titled  
**Land use rights:** individual (most land is privately owned). The streams are not privately owned.  
 Therefore permits are required to construct a water harvesting structure. Some shrubland or forest is state-owned.  
**Water use rights:** individual. Water rights are provided and controlled by the water authority of the Segura river basin (CHS).  
**Relative level of wealth** average, which represents 80% of land users; 75% of the total land area is owned by average land users

**Importance of off-farm income:** > 50% of all income: there is no difference in the ones who apply the technology and those who do not. Most farmers do have an off-farm income for example from hunting, work in a factory or office.  
**Access to service and infrastructure:** moderate: employment, energy; high: health, education, technical assistance, market, roads & transport, drinking water and sanitation, financial services  
**Market orientation:** commercial / market  
**Mechanization:** mechanised  
**Livestock grazing on crop residues:** yes

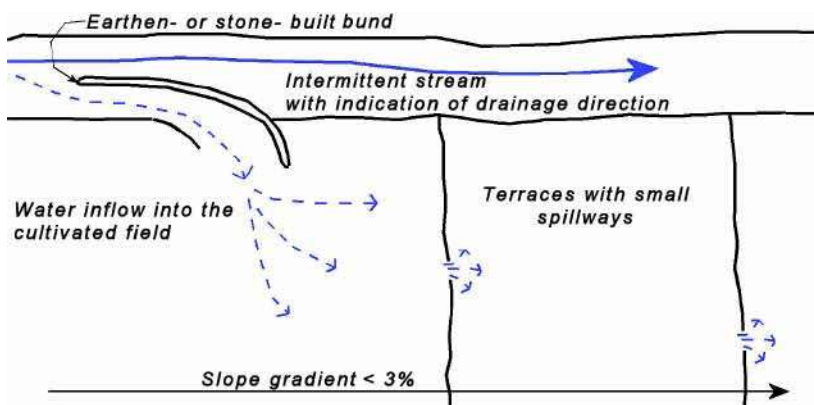

### Technical drawing

Sketch of a water harvesting structure consisting of an earthen- or stone- built bund that diverts water into cultivated fields. Several terraces are present in the fields in order to reduce slope gradient and retain water longer within the fields to allow maximum infiltration. Depending on the expected inflow of water several spillways can be made per terrace to prevent excessive concentration of flow in each spillway. (Joris de Vente)

## Implementation activities, inputs and costs

### Establishment activities

1. Construction of a bund (dam)

### Establishment inputs and costs per ha

Inputs	Costs (US\$)	% met by land user
Labour	150	100
Equipment - machine use	350	100
Construction material - concrete	400	100
<b>TOTAL</b>	<b>900</b>	<b>100</b>

### Maintenance/recurrent activities

1. Restoration of the bund

### Maintenance/recurrent inputs and costs per ha per year

Inputs	Costs (US\$)	% met by land user
Labour	4	100
Equipment - machine use	12	100
Construction material - concrete	25	100
<b>TOTAL</b>	<b>41</b>	<b>100</b>

**Remarks:** Labour costs and price of concrete are the most determinate factors affecting the costs. The costs were indicated assuming a length of the bund dimensions of 5x1x1 metres. Maintenance is required once every 5 years, so yearly costs are the total costs divided by 5. The local wage rate is 79 US\$/day (prices are for spring 2008).

## Assessment

### Impacts of the Technology

#### Production and socio-economic benefits

- +++ increased crop yield
- +++ increased farm income
- ++ increased irrigation water availability / quality
- + reduced risk of production failure

#### Production and socio-economic disadvantages

- + increased expenses on agricultural inputs

#### Socio-cultural benefits

- ++ improved conservation / erosion knowledge

#### Socio-cultural disadvantages

- + increased conflict over downstream effects

#### Ecological benefits

- ++ improved harvesting / collection of water
- + increased water quantity
- + increased soil moisture
- + reduced surface runoff
- + improved excess water drainage
- + recharge of groundwater table aquifer

#### Ecological disadvantages

none

#### Off-site benefits

- + reduced downstream flooding
- + reduced damage on public / private infrastructure

#### Off-site disadvantages

none

#### Contribution to human well-being/livelihoods

+ during Roman and Arab times when most structures were operative they increased significantly the production. Nowadays, most of them are abandoned. However, those that are operational do cause increased crop yields.

+++: high, ++: medium, +: low

#### Benefits/costs according to land user

Benefits compared with costs	short-term:	long-term:
<b>Establishment</b>	negative	positive
<b>Maintenance/recurrent</b>	positive	positive

Implementation of the technology is relatively expensive. Once installed, maintenance is not expensive and pays off because of higher productivity.

**Acceptance/adoption:** One hundred per cent of land user families have implemented the technology voluntarily. There is no (growing) trend towards spontaneous adoption of the technology. Much of this knowledge is forgotten and not applied or maintained anymore.

### Concluding statements

#### Strengths and → how to sustain/improve

This technology is very effective at increasing water available for crop production and so increasing crop yield and farm income → temporarily store the harvested water in a cistern to be used for irrigation using drip irrigation when most needed.

The technology takes advantage of floodwater that is otherwise lost because of the erratic character and short duration of flow → find optimal location for the water harvesting structures using a modelling approach.

#### Weaknesses and → how to overcome

The implementation costs are relatively high when the bunds are made of concrete → use of cheap materials that are freely available (stones from the fields). However, it is important to make the structure as resistant as possible against flood events.

The water provided by these techniques is mostly interesting for small- and medium- scale rainfed farming. Intensively irrigated farming requires more water and a guarantee for water independently of flood events → intensively irrigated farming might use this technology as an additional source of water and may store the harvested water in a cistern for use when needed.

Farmers consider it relatively expensive to implement and there is no guarantee for water as this depends on the rainfall events → subsidies might help to install these structures where feasible. Therefore, good assessments of expected water inflow volumes are required before construction.

**Key reference(s):** Frot, E., van Wesemael, B., Benet, A.S. and House, M.A., 2008. Water harvesting potential in function of hillslope characteristics: A case study from the Sierra de Gador (Almeria province, south-east Spain). *Journal of Arid Environments*, 72(7): 1213-1231

**Contact person(s):** Joris de Vente, EEZA-CSIC, Joris@sustainable-ecosystems.org



## Water-spreading weirs for the development of degraded dry river valleys

Chad - *Seuils d'épandage pour la valorisation des vallées d'oued dégradées (French)*

**Water-spreading weirs are structures that span the entire width of a valley to spread floodwater over the adjacent land area.**

Over the last 12 years water-spreading weirs have been introduced and improved as a new rehabilitation technique for degraded dry valleys in Burkina Faso, Niger and Chad. In Chad 104 water-spreading weirs were constructed in the scope of the two development projects, initiated by the German Technical Cooperation (GIZ) and the Swiss Development Cooperation (SDC) in the 1990s. Water-spreading weirs are made of natural stones and cement, and consist of a spillway in the actual riverbed and lateral abutments and wings. Floodwaters are spread over the adjacent land area above the structure, where they eventually overflow the lateral wings and then slowly flow back towards the riverbed below the structure. As a result the land area below the weir is flooded. The lateral spreading of the water causes the land area above and below the structure to be flooded and supplies it with sediment. Water infiltrates, gullies in the valley are filled and the riverbed is raised. Thanks to the infiltration, the groundwater table also rises in a few years.

In dry valleys in which water flows in the rivers for only a few days a year, the weirs serve to distribute the incoming runoff over the valley floor and allow as much water as possible to infiltrate the soil. The aquifer is thus replenished and is then available for agricultural use. In contrast to the various types of dams, the goal of water-spreading weirs is not to create reservoirs for later use. What water-spreading weirs do is cause a temporary flooding of the adjacent land area above and below the weir. Depending on user preferences, the primary goal may be 1) agricultural use, 2) silvo-pastoral use or 3) the replenishment and rising of the water table. Water-spreading weirs require detailed technical planning and experienced engineering and construction firms. The bulk of the work is performed using local materials and by village craftsmen and helpers.

Compared to small impoundment dams, retention basins and microweirs, water-spreading weirs are especially well-suited for shallow, wide valleys that, due to severe gully erosion, are no longer inundated by small and medium volume floodwaters. The flooding no longer takes place because the actual riverbed has been deeply eroded and enlarged. However, water-spreading weirs are also suitable for improving agricultural productivity in more or less intact valley floors. Water-spreading weirs are successful in regions where precipitation during the growing season is erratic and where the weirs ensure a more evenly distributed water supply for crops, as well as in zones in which water enrichment makes one or two additional growing seasons possible. At the present time they are in use in a broad area where annual rainfall ranges from 50 to 1,200 mm/year.

**Above left:** Aerial view of a water-spreading diversion weir. (Photo: Heinz Bender)  
**Above right:** Water-spreading diversion weir during the rainy season. (Photo: Heinz Bender)

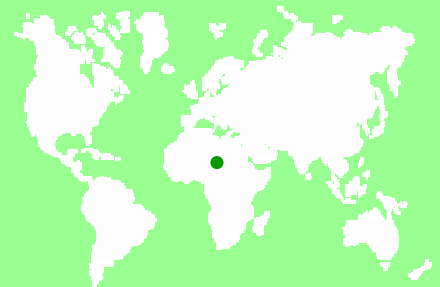

**Location:** Ouaddai-Biltine, Seuils, Ennedi, Wadi Fira, Biltine, Iriba, Guereda, Abéché, Salamat Ouaddai Goz Beida

**Region:** Northeast, East and Southeast Chad

**Technology area:** 20 km<sup>2</sup>

**Conservation measure:** structural

**Stage of intervention:** rehabilitation /

reclamation of denuded land

**Origin:** developed externally / introduced through project, 10-50 years ago

**Land use:** cropland

**Climate:** semi-arid, subtropics

**WOCAT database reference:** QT CHA001en

on [cdewocat.unibe.ch/wocatQT](http://cdewocat.unibe.ch/wocatQT)

**Related approach:** not documented

**Compiled by:** Heinz Bender, Wybergstrasse 41, CH-8542 Wiesendangen, Switzerland

**Date:** 08th March 2012



## Classification

**Land use problems:** There is a lack of water for irrigation of crops limiting the crop types that can be planted as well as the crop yield of dryland farming. A lack of water availability seriously limits the production potential of the soil and results in a low vegetation/crop cover. The relatively high soil erosion rates cause various off-site related problems (i.e. flooding, reservoir siltation) and on-site problems (i.e. gully formation and loss of soil depth).

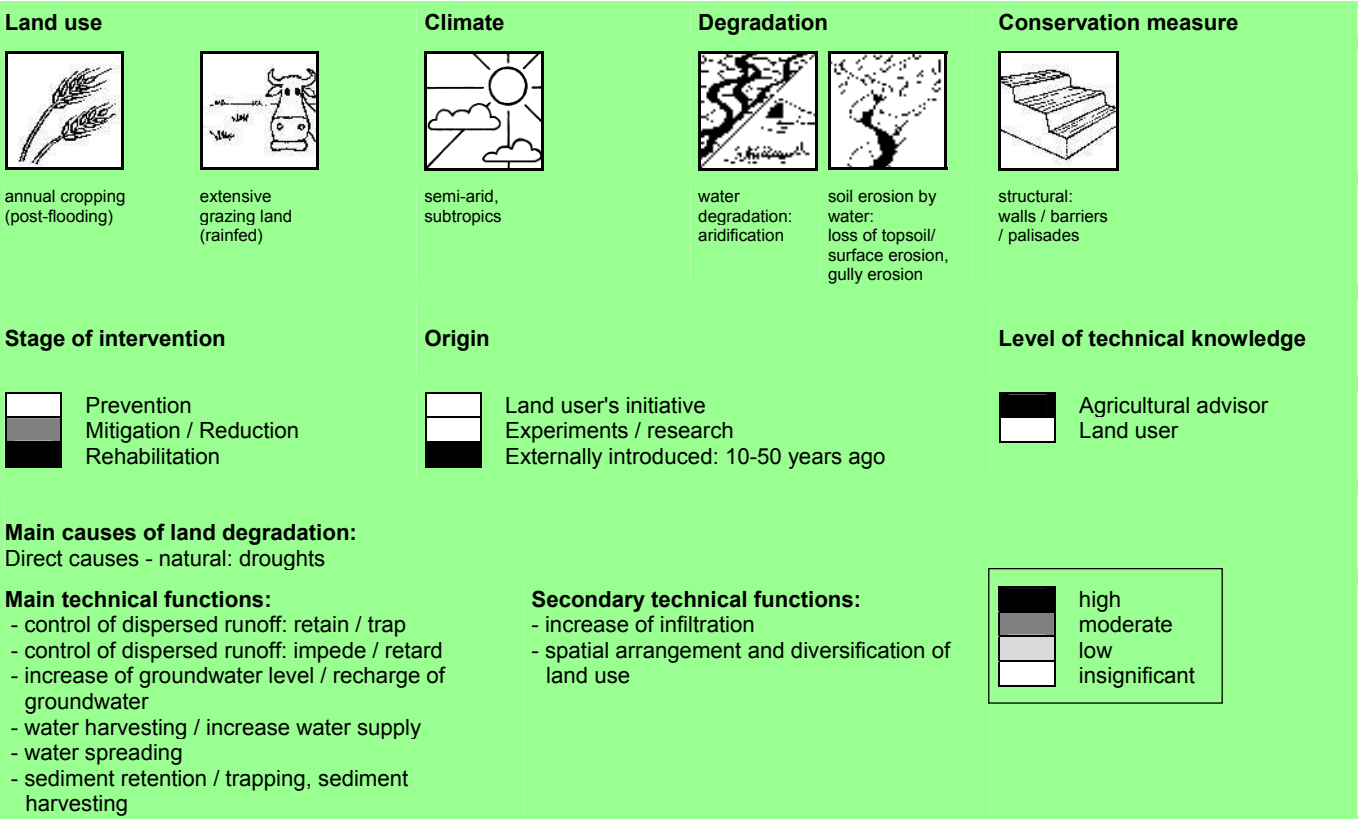

## Environment

### Natural Environment

#### Average annual rainfall (mm)

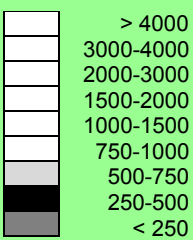

#### Altitude (m a.s.l.)

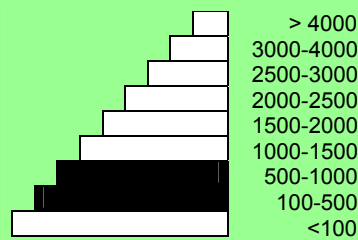

#### Landform

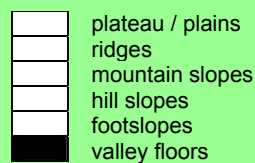

#### Slope (%)

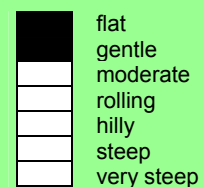

#### Soil depth (cm)

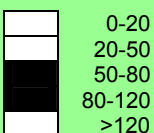

**Growing season(s):** 70-80 days (June until September)

**Soil texture:** fine / heavy (clay)

**Soil fertility:** high

**Topsoil organic matter:** medium (1-3%)

**Soil drainage/infiltration:** medium

**Soil water storage capacity:** medium

**Ground water table:** 5 - 50 m

**Availability of surface water:** excess (e.g. flood), poor / none

**Water quality:** good drinking water

**Biodiversity:** medium

**Tolerant of climatic extremes:** temperature increase, seasonal rainfall increase, heavy rainfall events (intensities and amount), wind storms / dust storms, floods

**Sensitive to climatic extremes:** no data

**If sensitive, what modifications were made / are possible:** no data

## Human Environment

### Cropland per household (ha)

█	<0.5
█	0.5-1
█	1-2
█	2-5
█	5-15
█	15-50
█	50-100
█	100-500
█	500-1,000
█	1,000-10,000
█	>10,000

**Land user:** groups / community  
**Population density:** < 10 persons /km<sup>2</sup>  
**Annual population growth:** 1 - 2%  
**Land ownership:** communal / village  
**Land use rights:** leased (In Chad, only the rainfed fields are in private family ownership and inheritable. Reclaimed irrigated fields and vegetable production fields go back to the community and can be redistributed.)  
**Water use rights:** oral conventions  
**Relative level of wealth** poor, which represents 70% of land users.

**Importance of off-farm income:** less than 10% of all income:  
**Access to service and infrastructure:** no data  
**Market orientation:** mixed (subsistence and commercial)  
**Mechanization:** mainly manual labour  
**Livestock grazing on crop residues:** little (Predominantly in the northern regions there is livestock. Further south farmers cultivate millet, sorghum, peanuts and sesame).

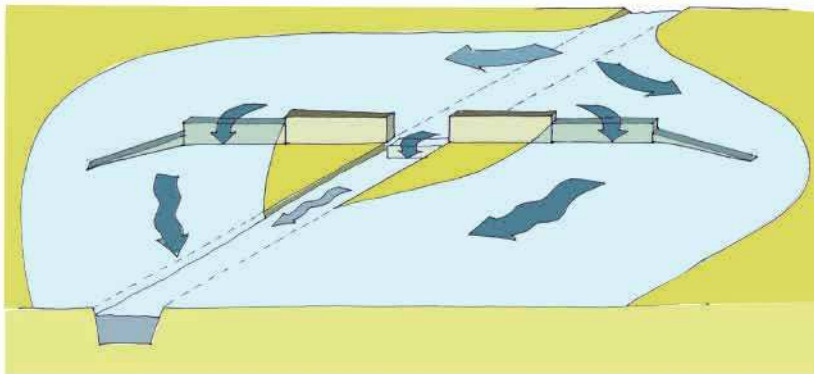

### Technical drawing

Water-spreading weir with spillway, lateral abutments and wing walls. (Heinz Bender)

## Implementation activities, inputs and costs

### Establishment activities

1. Excavating the steps
2. Excavating the wall foundations
3. Pouring the foundations
4. Building the walls
5. Finishing the walls and filling the stilling basin

### Establishment inputs and costs per ha

Inputs	Costs (US\$)	% met by land user
Labour	750	100
Equipment	750	0
Construction material - stone	750	0
<b>TOTAL</b>	<b>2250</b>	<b>33.33</b>

### Maintenance/recurrent activities

Repairs when needed

### Maintenance/recurrent inputs and costs per ha per year

Inputs	Costs (US\$)	% met by land user
Labour	50	100
Equipment	50	
Construction material - stone	50	
<b>TOTAL</b>	<b>150</b>	<b>33.33</b>

**Remarks:** The costs were calculated per structure (one diversion weir). The length of the weir varies depending on the width of the valley it is constructed in. The weir has to span the whole valley which is usually between 100 and 1000 m wide.



## Assessment

### Impacts of the Technology

#### Production and socio-economic benefits

- +++ increased crop yield
- +++ increased farm income
- ++ increased irrigation water availability / quality
- + reduced risk of production failure

#### Production and socio-economic disadvantages

none

#### Socio-cultural benefits

- +++ community institution strengthening
- +++ improved situation of disadvantaged groups
- +++ improved food security / self sufficiency
- ++ conflict mitigation
- ++ improved conservation / erosion knowledge
- ++ improved health
- ++ diversification and creation of activities
- ++ improved planning skills
- ++ poverty reduction
- + training for weir construction

#### Socio-cultural disadvantages

none

#### Ecological benefits

- +++ increased water quantity
- +++ improved harvesting / collection of water
- +++ increased soil moisture
- +++ reduced surface runoff
- +++ recharge of groundwater table / aquifer
- +++ increased biomass above ground C
- +++ reduced soil loss
- ++ increased nutrient cycling recharge
- ++ increased soil organic matter / below ground C
- ++ increased animal diversity
- ++ increased plant diversity
- ++ increased / maintained habitat diversity

#### Ecological disadvantages

none

#### Off-site benefits

- +++ increased water availability
- +++ reduced downstream flooding
- +++ reduced downstream siltation
- +++ improved buffering / filtering capacity

#### Off-site disadvantages

none

#### Contribution to human well-being/livelihoods

- +++ food security, improved access to water and therefore less work for women, additional income, work migration of men abroad not necessary anymore

+++: high, ++: medium, +: low

#### Benefits/costs according to land user

Benefits compared with costs	short-term:	long-term:
<b>Establishment</b>	negative	very positive
<b>Maintenance/recurrent</b>	slightly positive	very positive

Depending upon the users' experience and the availability of labour, it may take anywhere from 2 to 10 years before the rehabilitated land area reaches its optimum use potential.

**Acceptance/adoption:** 100% of land user families have implemented the technology with external material support. Between 4000 and 8000 households are direct beneficiaries of the construction of water-spreading weirs in Eastern Chad. There is no trend towards (growing) spontaneous adoption of the technology. It is unlikely that communities will be able to adopt this technology without external funding. Even for maintenance activities it remains to be seen if the communities will be capable of funding more extensive maintenance work with their low budgets.

## Concluding statements

### Strengths and → how to sustain/improve

Through the construction of water-spreading weirs, soils are regularly flooded and supplied with water and sediment. Thus, the arable land area and the yields of the rainy season crops serving as staple food increase → ensure proper maintenance of the system.

The more frequent flooding of the soils results in increased infiltration, and the groundwater level rises substantially.

Prior to rehabilitation, in most of the sites, it was only possible to grow a rainfed crop and perhaps an irrigated crop on some small areas of land. After, in addition to the rainfed crop grown on larger areas of land, it became possible to grow a post-rainy season crop ("culture de contresaison") and, once the water table had risen, an irrigated crop ("culture de décrue") as well → upscale water-spreading weirs to increase the number of people benefitting.

Post-rainy season crops and irrigated crops diversify agricultural production. They are used as a means of earning cash income. → improve access to markets.

With their capacity to regulate annual floodwaters and harness them to stabilise production, water-spreading weirs are an effective measure for adapting to climate change in regions experiencing increasing variability in rainfall.

### Weaknesses and → how to overcome

It can be assumed that one third of the weirs will require complete renovation every 20 years → the renovation of these weirs can be done for approximately 10% of the initial construction costs.

Maintenance of the weirs by the management committees is still a weak area. Funds expected from user fees for the plots are often inadequately collected and too low to cover costs. Some management committees lose their drive and neglect their duties.

In spite of the great potential for the use of water-spreading weirs and the very promising results, implementation will continue to depend in the medium term on outside funding, as it is unlikely that the communal budgets will be able to fund investments of this size → new funding sources have to be found and tapped.

Know-how and experience for the construction of water-spreading weirs are still concentrated among a few countries → the existing knowledge has to be spread.

**Key reference(s):** Deutsche Gesellschaft für Internationale Zusammenarbeit (GIZ) (2011). Water-spreading weirs for the development of degraded dry river valleys. Experience from the Sahel. Frankfurt and Eschborn, GIZ and KfW (<http://www.gtz.de/de/dokumente/giz2012-en-water-spreading-weirs-sahel.pdf>) / Direction du développement et de la coopération DDC (2012). Gestion des eaux de ruissellement dans le Tchad sahélier. Bern, DDC. ([http://www.gopa.de/uploads/tx\\_bdojobopps/PRODOC\\_Tchad.pdf](http://www.gopa.de/uploads/tx_bdojobopps/PRODOC_Tchad.pdf))

**Contact person(s):** Heinz Bender, Wybergstrasse 41, CH-8542 Wiesendangen, [heinz\\_bender@bluewin.ch](mailto:heinz_bender@bluewin.ch) / Alexander Schöning, [alexander.schoening@giz.de](mailto:alexander.schoening@giz.de) / Dieter Nill, [dieter.nill@giz.de](mailto:dieter.nill@giz.de)





## Jessour

Tunisia - *Jesser, Katra* (Arabic)

### Jessour is an ancient runoff water harvesting technique widely practised in the arid highlands

*Jessour* technology is generally practised in mountain dry regions (less than 200 mm annually) with medium to high slopes. This technology was behind the installation of very old olive orchards based on rainfed agriculture in rugged landscapes which allowed the local population not only to ensure self-sufficiency but also to provide neighbouring areas many agricultural produces (olive oil, dried figs, palm dates, etc.).

*Jessour* is the plural of *jessr*, which is a hydraulic unit made of three components: the impluvium, the terrace and the dyke. The impluvium or the catchment is the area which collects and conveys runoff water. It is bordered by a natural water divide line (a line that demarcates the boundary of a natural area or catchment, so that all the rain that falls on this area is concentrated and drained towards the same outlet). Each unit has its own impluvium, but can also receive excess water from upstream units. The terrace or cropping zone is the area in which farming is practised. It is formed progressively by the deposition of sediment. An artificial soil will then be created, which can be up to 5 m deep close to the dyke. Generally, fruit trees (e.g. olive, fig, almond, and date palm), legumes (e.g. pea, chickpeas, lentil, and faba bean) and barley and wheat are cultivated on these terraces.

Although the *jessour* technique was developed for the production of various agricultural crops, it now also plays three additional roles: (1) aquifer recharge, via runoff water infiltration into the terraces, (2) flood control and therefore the protection of infrastructure and towns built downstream, and (3) wind erosion control, by preventing sediment from reaching the downstream plains, where windspeed can be particularly high.

In the *Jessour*, a dyke (*tabia, sed, katra*) acts as a barrier used to hold back sediment and runoff water. Such dykes are made of earth, and are equipped with a central and/or lateral spillway (*masref* and/or *manfes*) and one or two abutments (*ktef*), assuring the evacuation of excess water. They are trapezoidal and measure 15-50 m in length, 1-4 m in width and 2-5 m in height. In old units, the dyke is stabilised with a covering of dry stones to overcome the erosive effects of water wave action on the front and back of the dyke. The spillway is made of stones arranged in the form of stairs, in order to dissipate the kinetic energy of the overflow.

This technology is currently encountered in the mountain ranges of Matmata of South Eastern Tunisia where the local agricultural activities are based mainly on rainfed agriculture and livestock breeding. However, high rates of migration to cities may threaten the long-term maintenance of those structures.

**Above left:** *Jessour* is the plural of a *Jessr* which is the hydraulic unit comprising a dyke, spillway, terrace (cropping area: fruit trees and annuals), and impluvium (runoff catchment area). (Photo: H. Van Delden )

**Above right:** *Jessour* is an ancient runoff water harvesting technique widely practised in the arid highlands of southern Tunisia. After each rainfall event, significant volumes of runoff water accumulate on the terrace and infiltrate into the soil to sustain trees and crops. The spillway ensures sharing the runoff water with downstream users and the safe discharge of excess water. (Photo: Mohamed Ouessar)

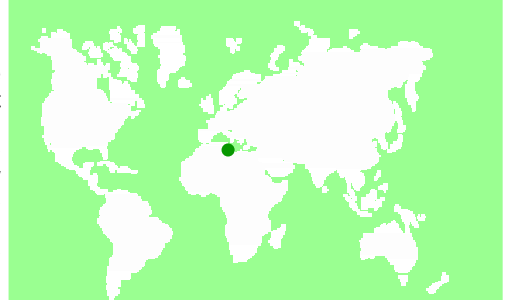

**Location:** Medenine

**Region:** Beni Khedache

**Technology area:** 100 km<sup>2</sup> - 1,000 km<sup>2</sup>

**Conservation measure:** structural

**Stage of intervention:** mitigation / reduction of land degradation

**Origin:** developed trough land users initiative, traditional (>50 years ago)

**Land use:** grazing land

**Climate:** arid, subtropics

**WOCAT database reference:** QT TUN009en on cdeiwocat.unibe.ch/wocatQT

**Related approach:** dryland watershed management approach (QA TUN09)







**Compiled by:** Mohamed Ouessar, Mongi Ben Zaied, Mongi Chniter, Institut des Régions Arides (IRA), Tunisia

**Date:** 22nd Sep 2008, updated 10th Jun 2011

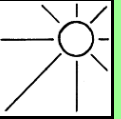

## Classification

**Land use problems:** Loss of surface water (runoff), problems of flooding, water erosion, soil degradation, drought

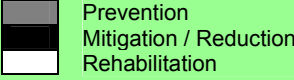
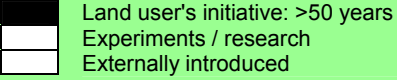
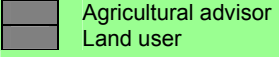
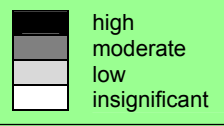
Land use		Climate		Degradation		Conservation measure	
							
extensive grazing land (before)	tree and shrub cropping (rainfed) (after)	annual cropping (rainfed) (after)	arid, subtropics	soil erosion by water: loss of topsoil/ surface erosion	water degradation: aridification	structural: bunds / banks	
Stage of intervention			Origin			Level of technical knowledge	
							
<p><b>Main causes of land degradation:</b>            Direct causes - human induced: crop management (annual, perennial, tree/shrub)            Direct causes - natural: change of seasonal rainfall, heavy / extreme rainfall            Indirect causes: poverty / wealth</p>							
<p><b>Main technical functions:</b>            - harvesting of runoff water / water trapping            - increase of infiltration            - sediment retention / trapping, sediment harvesting</p>			<p><b>Secondary technical functions:</b>            - control of concentrated runoff: retain / trap            - increase / maintain water stored in soil            - increase of groundwater level, recharge of groundwater</p>				

## Environment

### Natural Environment

#### Average annual rainfall (mm)

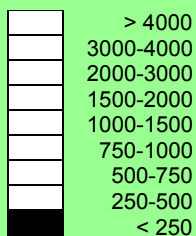

#### Altitude (m a.s.l.)

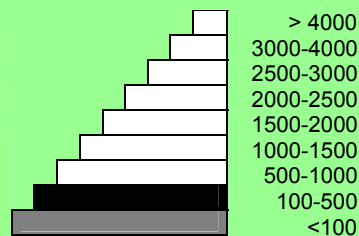

#### Landform

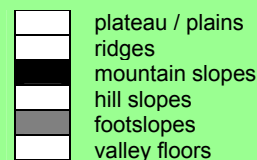

#### Slope (%)

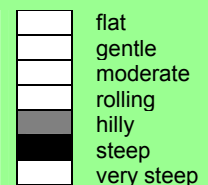

#### Soil depth (cm)

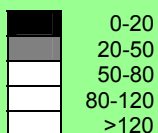

**Growing season(s):** 180 days (October until May)  
**Soil texture:** medium (loam)  
**Soil fertility:** very low  
**Topsoil organic matter:** low (<1%)  
**Soil drainage/infiltration:** medium











**Soil water storage capacity:** without Jessour: poor; with Jessour: medium to high  
**Ground water table:** 5 - 50 m  
**Availability of surface water:** poor only episodic streams  
**Water quality:** poor drinking water  
**Biodiversity:** medium

**Tolerant of climatic extremes:** temperature increase, seasonal rainfall increase, seasonal rainfall decrease, heavy rainfall events (intensities and amount), wind storms / dust storms, droughts / dry spells, decreasing length of growing period

**Sensitive to climatic extremes:** floods

## Human Environment

### Mixed land per household (ha)

	<0.5
	0.5-1
	1-2
	2-5
	5-15
	15-50
	50-100
	100-500
	500-1,000
	1,000-10,000
	>10,000

**Land user:** individual, small-scale land users, average land users, mainly men  
**Population density:** 10-50 persons/km<sup>2</sup>  
**Annual population growth:** < 0.5%  
**Land ownership:** individual, not titled  
**Land use rights:** individual (the communal rule applies in this region: the farmer owns the terrace (the cropping area) and its impluvium from which the runoff is harvested).  
**Water use rights:** individual  
**Relative level of wealth:** average, which represents 80% of land users; 75% of the total land area is owned by average land users

**Importance of off-farm income:** > 50% of all income: the technology is very ancient and, therefore, all the farmers apply this technology. The only difference is the number of the owned *Jessour*. Off-farm incomes come from migration, construction works, commerce, tourism sector, administration or informal activities.  
**Access to service and infrastructure:** low: financial services; moderate: health, technical assistance, employment, market, energy, roads & transport, drinking water and sanitation; high: education  
**Market orientation:** subsistence (self-supply)

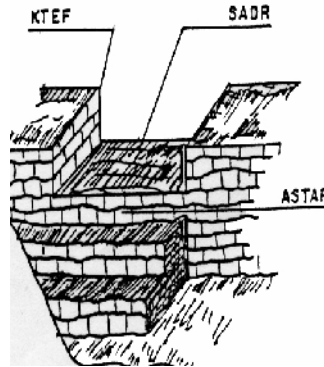
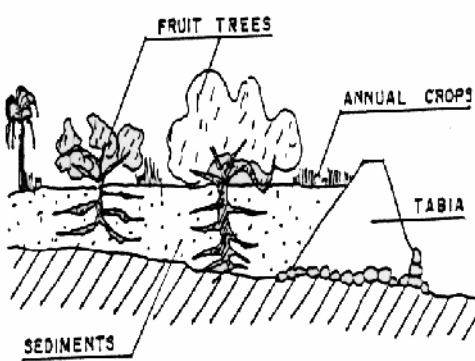

### Technical drawing

**Left:** Cross-section of dyke (locally called *tabia*) and terrace (cropping area). The *Jessour* ensure the collection of both runoff water and sediments allowing creating very deep 'artificial' soils (terrace) which form a very good reservoir for water and nutrients to be used by fruit trees and annual crops.  
**Right:** The spillway allows the overflow to the other *Jessour* downstream. It also represents the symbol of water sharing equity between different farmers in the same watershed. (Drawing adapted from El Amami (1984)) (Mohamed Ouessar)

## Implementation activities, inputs and costs

### Establishment activities

1. Dyke construction
2. Plantations
3. Spillway construction

### Establishment inputs and costs per one *Jessour* per year

Inputs	Costs (US\$)	% met by land user
Labour	1'200	
Construction material	1'000	
Agricultural	800	
<b>TOTAL</b>	<b>3'000</b>	<b>100*</b>

### Maintenance/recurrent activities

1. Crop and trees maintenance
2. Dyke and spillway maintenance
3. Repairs
4. Tillage (against soil sealing)

### Maintenance/recurrent inputs and costs per one *Jessour* per year

Inputs	Costs (US\$)	% met by land user
Labour	400	
Construction material	300	
Agricultural	200	
<b>TOTAL</b>	<b>900</b>	<b>100*</b>

**Remarks:** Found in inaccessible and even remote areas, labour is the most determining factors affecting the costs of this system. The local wage rate is 10 US\$/day.

\* The technology establishment and maintenance costs met by the land users are 100% if executed on a private basis, but it can range from 10 to 50% when the site is subject to a publicly-funded programme.

## Assessment

### Impacts of the Technology

#### Production and socio-economic benefits

- +++ increased crop yield
- ++ reduced risk of production failure
- ++ increased farm income
- + diversification of income sources

#### Production and socio-economic disadvantages

- ++ reduced grazing lands
- ++ reduced available runoff for downstream users

#### Socio-cultural benefits

- ++ improved conservation / erosion knowledge
- ++ improved situation of disadvantaged groups
- ++ improved food security / self sufficiency

#### Socio-cultural disadvantages

- + socio cultural conflicts

#### Ecological benefits

- +++ improved harvesting / collection of water
- ++ reduced surface runoff
- ++ reduced hazard towards adverse events
- ++ reduced soil loss
- + recharge of groundwater table aquifer

#### Ecological disadvantages

none

#### Off-site benefits

- ++ increased water availability
- ++ reduced downstream flooding
- ++ reduced downstream siltation
- + decreased damage on infrastructure

#### Off-site disadvantages

- ++ reduced river flows (only during floods)
- ++ reduced sediment yields

#### Contribution to human well-being/livelihoods

- ++

+++: high, ++: medium, +: low

Benefits/costs according to land user	Benefits compared with costs	
	short-term:	long-term:
	Establishment	very negative
Maintenance/recurrent	neutral	positive

**Acceptance/adoption:** Ten per cent of land user families have implemented the technology with external material support. Ninety per cent of land user families have implemented the technology voluntarily. This technique is ancient and it is therefore already fully adopted / used in the region.

## Concluding statements

### Strengths and →how to sustain/improve

This technique allowed a expansion of cropping lands in the mountain area → encourage maintenance of existing structure.

Allows crop production in very dry environments (with less than 200 mm of rainfall) → encourage maintenance of existing structure.

Collects and accumulates water, soil and nutrients behind the *tabia* and makes it available to crops → encourage maintenance of existing structure.

Reduced damage by flooding → encourage maintenance of existing structure.

Well adapted technology for the ecological environment → ensure maintenance works.

Well known technique by the local population → training of new generations.

### Weaknesses and →how to overcome

Risks related to the climatic changes → it needs to be combined with supplemental irrigation.

Risk of local know-how disappearance → training of new generations.

Land ownership fragmentation → agrarian reform, new land access.

Productivity of the land is very low → development of alternative income generation activities.

**Key reference(s):** El Amami, S. 1984. Les aménagements hydrauliques traditionnels en Tunisie. Centre de Recherche en Génie Rural (CRGR), Tunis, Tunisia. 69 pp. / Ben Mechlia, N., Ouessar, M. 2004. Water harvesting systems in Tunisia. In: Oweis, T., Hachum, A., Bruggeman, A. (eds). Indigenous water harvesting in West Asia and North Africa, ICARDA, Aleppo, Syria, pp: 21-41.

**Contact person(s):** Ouessar Mohamed (Med.Ouessar@ira.agrinet.tn), Sghaier Mongi (sghaier.mon@gmail.com), Institut des Régions Arides, 4119 Medenine, Tunisia



## Tabia

Tunisia

**The *tabia* earthen dyke is a water harvesting technique used in the foothill and piedmont areas.**

The *tabia* technology is similar to the *jessour* system but is used in the gently-sloping foothill and piedmont areas. It is considered to be a relatively new technique, developed by mountain dwellers who migrated to the plains. *Tabias*, like *jessour*, comprise an earthen dyke (50-150 m in length, 1-2 m in height), a spillway (central and/or lateral) and an associated water harvesting area. The ratio between the area where water is applied (cropped area) and the total area from which water is collected varies from 1:6 to 1:20. The differences between the *tabia* and the *jessour* systems are that the former contains two additional lateral bunds (up to 30 m long) and sometimes a small flood diversion dyke (*mgoud*). Small *tabia* are constructed manually using shovels, pickles and carts. Larger constructions are done mechanically using tractors and bulldozers.

Tree products and annual crops are commonly grown using *tabia*. Besides their water harvesting qualities, *tabias* also have a positive effect on soil erosion and groundwater recharge.

The *tabia* runoff-water harvesting technique is widely practised in central Tunisia. *Tabias* are usually installed on the piedmont, where the slope does not exceed 3% and where the soil is relatively deep. Ancient remnants of *tabias* have been found in the region of Gafsa (south west Tunisia). The system has been adopted by people living in the neighbouring foothills and plains of the central and southeastern regions (Jeffara) of the country, following the transformation of their pasture to cultivated fields.

**Above left:** *Tabia* on the piedmont area. Tree products (olive, almond, fig, palm) and annuals (barley) can be harvested. (Photo: Mongi Chniter)

**Above right:** *Tabia* earthen dam in the plain. Olive trees are generally grown along the dam, where the harvested water infiltrates better. (Photo: Mohamed Ouessar)



**Location:** Medenine

**Region:** Medenine nord

**Technology area:** 10 - 100 km<sup>2</sup>

**Conservation measure:** structural

**Stage of intervention:** prevention of land degradation

**Origin:** externally introduced, 10-50 years ago

**Land use:** cropland, grazing land

**Climate:** arid, subtropics

**WOCAT database reference:** QT TUN012en on cdewocat.unibe.ch/wocatQT

**Related approach:** Dryland watershed management approach (QA TUN09)

**Compiled by:** Mohamed Ouessar, Mongi Chniter, Institut des Régions Arides (IRA), Tunisia



**Date:** 30th Jan 2009, updated 5th Jul 2011



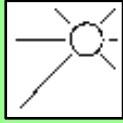

## Classification

**Land use problems:** soil erosion by water, runoff and soil loss, overgrazing

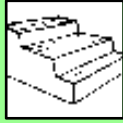
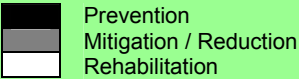
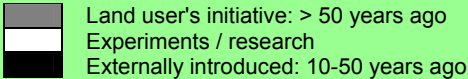
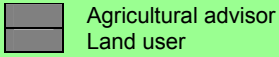
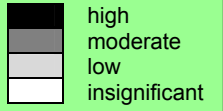
<p><b>Land use</b></p>  <p>tree and shrub cropping (rainfed)      extensive grazing land</p>	<p><b>Climate</b></p>  <p>arid, subtropics</p>	<p><b>Degradation</b></p>  <p>soil erosion by water: loss of topsoil / surface erosion</p>	<p><b>Conservation measure</b></p>  <p>structural: bunds / banks</p>
<p><b>Stage of intervention</b></p>  <p>Prevention Mitigation / Reduction Rehabilitation</p>	<p><b>Origin</b></p>  <p>Land user's initiative: &gt; 50 years ago Experiments / research Externally introduced: 10-50 years ago</p>	<p><b>Level of technical knowledge</b></p>  <p>Agricultural advisor Land user</p>	
<p><b>Main causes of land degradation:</b> Direct causes - natural: heavy / extreme rainfall Indirect causes: land tenure</p>		<p><b>Secondary technical functions:</b> - increase of water infiltration - water spreading</p>	 <p>high moderate low insignificant</p>
<p><b>Main technical functions:</b> - control of concentrated runoff: retain / trap</p>			

## Environment

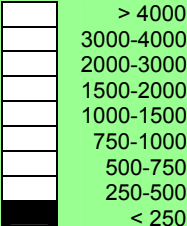
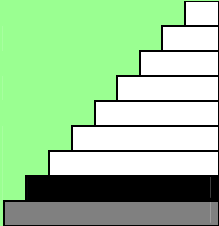
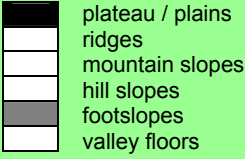
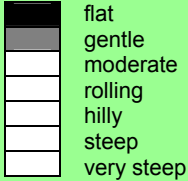
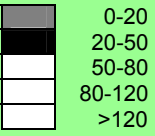
<p><b>Natural Environment</b></p>			
<p><b>Average annual rainfall (mm)</b></p>  <p>&gt; 4000 3000-4000 2000-3000 1500-2000 1000-1500 750-1000 500-750 250-500 &lt; 250</p>	<p><b>Altitude (m a.s.l.)</b></p>  <p>&gt; 4000 3000-4000 2500-3000 2000-2500 1500-2000 1000-1500 500-1000 100-500 &lt;100</p>	<p><b>Landform</b></p>  <p>plateau / plains ridges mountain slopes hill slopes footslopes valley floors</p>	<p><b>Slope (%)</b></p>  <p>flat gentle moderate rolling hilly steep very steep</p>
<p><b>Soil depth (cm)</b></p>  <p>0-20 20-50 50-80 80-120 &gt;120</p>	<p><b>Growing season(s):</b> 180 days (October - April) <b>Soil texture:</b> medium (loam) <b>Soil fertility:</b> very low <b>Topsoil organic matter:</b> low (&lt;1%) <b>Soil drainage/infiltration:</b> medium</p>		<p><b>Soil water storage capacity:</b> medium <b>Ground water table:</b> 5 - 50 m <b>Availability of surface water:</b> medium <b>Water quality:</b> medium <b>Biodiversity:</b> medium</p>
<p><b>Tolerant of climatic extremes:</b> temperature increase, seasonal rainfall increase, seasonal rainfall decrease, heavy rainfall events (intensities and amount), wind storms / dust storms, decreasing length of growing period <b>Sensitive to climatic extremes:</b> floods and droughts / dry spells</p>			

## Human Environment

### Mixed land per household (ha)

	<0.5
	0.5-1
	1-2
	2-5
	5-15
	15-50
	50-100
	100-500
	500-1,000
	1,000-10,000
	>10,000

**Land user:** individual, small-scale land users, average land users, mainly men  
**Population density:** 10-50 persons/km<sup>2</sup>  
**Annual population growth:** 0.5% - 1%  
**Land ownership:** individual, titled  
**Land use rights:** individual  
**Water use rights:** individual  
**Relative level of wealth:** average, which represents 70% of land users; 75% of the total land area is owned by average land users

**Importance of off-farm income:** > 50% of all income:

**Access to service and infrastructure:** low: financial services; moderate: health, technical assistance, employment, market, energy, roads and transport, drinking water and sanitation; high: education

**Market orientation:** mixed (subsistence and commercial)

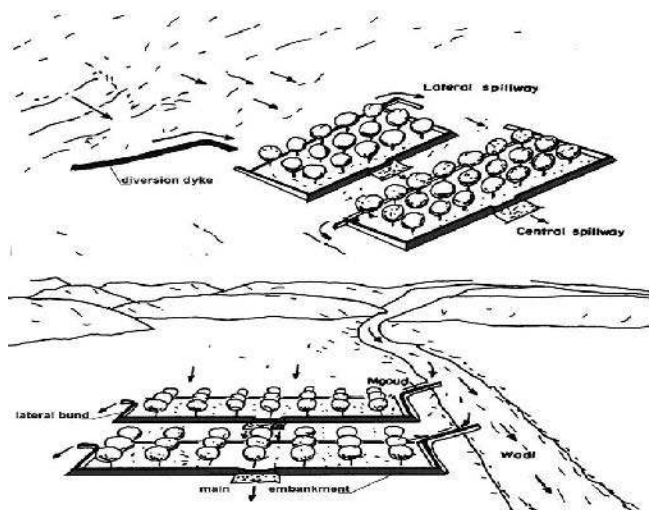

### Technical drawing

*Tabia* with natural water collection area (upper) and *tabia* on an expanded system with additional flood water diversions (lower). (Adapted from Alaya et al. 1993). Found in flatter areas, *tabia* can accommodate more trees on the terrace especially when it can receive additional water from floods.

## Implementation activities, inputs and costs

### Establishment activities

1. Diversion channel
2. Plantation
3. Spillway construction
4. Terracing

### Establishment inputs and costs per per medium-sized *Tabia*

Inputs	Costs (US\$)	% met by land user
Labour	500	
Other	170	
<b>TOTAL</b>	<b>670</b>	<b>100*</b>

### Maintenance/recurrent activities

1. Dyke and spillway maintenance
2. Reconstruction

### Maintenance/recurrent inputs and costs per per medium-sized *Tabia*

Inputs	Costs (US\$)	% met by land user
Labour	150	
Other	50	
<b>TOTAL</b>	<b>200</b>	<b>100*</b>

**Remarks:** Labour is the most determining factor affecting the costs. The local wage rate is 10 US\$/day.

\* The technology establishment and maintenance costs met by the land users are 100% if executed on a private basis, but it can range from 10 to 50% when the site is part of a publicly-funded programme.

## Assessment

Impacts of the Technology	
<b>Production and socio-economic benefits</b>	<b>Production and socio-economic disadvantages</b>
++ increased crop yield ++ reduced risk of production failure ++ increased farm income ++ increased production area	++ loss of grazing land
<b>Socio-cultural benefits</b>	<b>Socio-cultural disadvantages</b>
++ improved conservation / erosion knowledge + improved food security / self sufficiency	none
<b>Ecological benefits</b>	<b>Ecological disadvantages</b>
+++ improved harvesting / collection of water ++ reduced surface runoff ++ reduced hazard towards adverse events ++ reduced soil loss / erosion ++ recharge of groundwater table aquifer	+ increased evaporation
<b>Off-site benefits</b>	<b>Off-site disadvantages</b>
++ increased water availability + reduced downstream flooding + reduced downstream siltation + reduced damage on public / private infrastructure	+ reduced river flows (only during floods) + reduced sediment yields
<b>Contribution to human well-being/livelihoods</b>	
+	

+++ : high, ++ : medium, + : low

Benefits/costs according to land user	Benefits compared with costs	short-term:	long-term:
		<b>Establishment</b>	negative
	<b>Maintenance/recurrent</b>	positive	very positive

**Acceptance/adoption:** 35% of land user families have implemented the technology with external material support. 65% of land user families have implemented the technology voluntary. There is a strong trend towards (growing) spontaneous adoption of the technology.

## Concluding statements

Strengths and → how to sustain/improve	Weaknesses and → how to overcome
This technique allows a rapid expansion of cropping lands in the piedmont and flat areas → encourage maintenance of existing structure.	Risks related to the climatic changes → it needs to be combined with supplementary irrigation.
Allows crop production in very dry environments (with less than 200 mm of rainfall) → encourage maintenance of existing structure.	Risk of local know-how disappearance → training of new generations.
Collects and accumulates water, soil and nutrients behind the <i>tabia</i> and makes it available to crops → encourage maintenance of existing structure.	Land ownership fragmentation → agrarian reform.
Reduced damage by flooding → encourage maintenance of existing structure.	Productivity of the land is very low → development of alternative income generation activities.
	Drought spells → supplementary irrigation.
	Expansion is done at the expense of natural grazing land.

**Key reference(s):** Alaya, K., Viertmann, W., Waibel, Th. 1993. Les tabias. Imprimerie Arabe de Tunisie, Tunis, Tunisia. 192 pp. / Genin, D., Guillaume, H., Ouessar, M., Ouled Belgacem, A., Romagny, B., Sghaier, M., Taamallah, H. (eds) 2006. Entre la désertification et le développement: la Jeffara tunisienne. CERES, Tunis, 351 pp.

**Contact person(s):** Ouessar Mohamed (Med.Ouessar@ira.agrinet.tn), Chniter Mongi, Insitut des Régions Arides, 4119 Medenine, Tunisia

# MACROCATCHMENT WATER HARVESTING



Small reservoir, Syria. (Oweis, 2009)

## In a nutshell

### Short description

Macrocatchment water harvesting (MacroWH) systems usually consist of four components: the catchment area, the runoff conveyance system, the storage system and the application area. In the catchment area, rainwater runoff is collected from compacted surfaces, including hillsides, roads, rocky areas, open rangelands, cultivated and uncultivated land and natural slopes. Most MacroWH practices have a catchment area of less than 2 ha, in some cases however runoff is collected from catchments as large as 200 ha. The runoff is conveyed through overland, rill, gully or channel flow and either diverted onto cultivated fields (where water is stored in the soil) or into specifically designed storage facilities. There where concentrated runoff is directly diverted to fields, the application area is identical with the storage area, as plants can directly use the accumulated soil water. The application or cropping area is either terraced or located in flat terrain. The ratio of the catchment to the application area (usually cultivated) varies between 10:1 and 100:1. In the second case, a great variety of designed storage systems keep the water till it is used either adjacent to the storage facilities or further away (involving a conveyance system). The classification of technologies into FloodWH or MacroWH is not always straight forward. It depends on the catchment size (FloodWH>MacroWH), the size of rainfall event (FloodWH>MacroWH) and concentration / size of runoff which is tapped (FloodWH harvest from the channel flow, MacroWH collects sheet and rill flow and short-distance channel flow).

### Water storage and purpose

Water stored in the soil is directly used for plant and crop growth prolonging the growing season and bridging the dry spells allowing to produce crops and yields without demanding irrigation systems. Designed storage facilities cover a broad range of open or closed structures. Open storage include farm ponds and different types of dams (often earth dams). Closed structures can be groundwater dams or above and below-ground tanks or reservoirs. Such storage structures are often characterized by multipurpose use, prioritising domestic and livestock consumption. During dry spells the water may sometimes used for supplementary irrigation.

### Most common technologies

These are: hillside runoff / conduit systems; large semi-circular or trapezoidal bunds (earth or stone); road runoff systems and open surface water storage in dams, ponds and pans; groundwater dams (subsurface, sand and percolation dams); above- or below-ground tanks (cisterns); horizontal and injection wells.

### Applicability

MacroWH practices are applicable in arid, semi-arid to sub-humid zones where it is necessary to store water to bridge the dry season or to mitigate the impact of dry spells. They are often situated in natural or man-made depressions, or even in ephemeral riverbeds. MacroWH is required in areas with long dry periods and where rainfall fluctuates widely over time.

Improved water availability	
Drinking water (high quality)	+
Domestic use (household)	++
Livestock sedentary	++
Livestock pastoral	+++
Rainfed agriculture	++
Opportunistic irrigation	+
Supplementary irrigation	+++
Irrigation of backyard crops / kitchen gardens	++
Aquifer recharge	++
Development issues addressed	
Preventing / reversing land degradation	++
Maintaining and improving food security	+++
Reducing rural poverty	++
Creating rural employment	++
Supporting gender equity / marginalised groups	+
Reduced risk of production failure	++
Improving crop production (including fruit trees)	+++
Improving fodder production	++
Improving wood / fibre production	++
Improving water productivity	++
Trapping sediments and nutrients	+++
Enhancing biodiversity	+++
Natural disaster prevention / mitigation	++
Climate change mitigation	++
Climate change adaptation	
Resilience to extreme dry conditions	++
Resilience to variable rainfall	+++
Resilience to extreme rain and wind storms	++
Resilience to rising temperatures and evaporation rates	++

Importance: +++ high, ++ medium, + low, +/- neutral

## Resilience to climate variability

MacroWH systems are resilient to climate change as long as there is at least some precipitation and runoff. Several consecutive drought years always pose a problem, depending on the size of the storage system: they may lead to reservoirs failing to fill. During short dry spells MacroWH systems provide an adaptation option for land users, as they can use the stored water for supplementary irrigation.

### Main benefits

- Improved crop yields.
- Improved year-round access to water for domestic and livestock consumption, as well as for supplementary irrigation.
- Reduced risk of crop failure by bridging prolonged dry periods and as such contribute to food security and climate change adaptation.
- Reduced damage from soil erosion and flooding by storing excess runoff water.

### Main disadvantages

- Open and shallow rainwater ponds and dams may dry out after the rainy seasons, as the water is lost via seepage (except for rock catchment and sand dams) and evaporation.
- Health risks: open storage structures can be contaminated by animals and can provide a breeding ground for disease-carrying insects. Sand dams are often contaminated as they are seldom protected from animals.

### Benefit-cost ratio

Technology	short term	long term
Sunken stream beds ( <i>dohs</i> ) <sup>1</sup>	-/+	+++
Earth dams <sup>1</sup>	--	+++
Underground tanks <sup>2</sup>	++	+++
Overall <sup>3</sup>	--	+++

--- very negative; -- negative; - slightly negative; -/+ neutral; + slightly positive; ++ positive; +++ very positive

<sup>1</sup> (Liniger and Critchley, 2007), <sup>2</sup> (Wu et al., 2009), <sup>3</sup> (WOCAT, 2012)

Compared to MicroWH, costs for storage facilities can be substantial, including excavation and materials (cement, clay, polythene sheets etc.). For storage systems, the choice of sealant material closely affects maintenance costs and performance.

### Adoption and upscaling

Acknowledging the constraints and failures of large-scale irrigation schemes, decentralized small-scale supplementary irrigation is being increasingly used to support rainfed agriculture. MacroWH provides an efficient and relatively low-cost supply of drinking and irrigation water. Because MacroWH systems operate within a watershed scale, important issues that must be addressed are ownership, local institutions, and land / resource tenure.



Hillside conduit for cereal production, Syria. (HP. Liniger)



Farm pond in India. (HP. Liniger).



Establishment of a small water harvesting dam, Brazil. ([www.smallreservoirs.org](http://www.smallreservoirs.org)).



Check dam ponds for gully reclamation on gentle slopes and recharging of groundwater (HP. Liniger)



A traditional cistern in Egypt. (T. Oweis)

## Technologies

### Water storage in soil

**Hillside runoff / conduit:** Small conduits guide and concentrate runoff water on slopes (>10%) and deliver it to flat fields at the foot of the slope (0%–10%). Fields are levelled and surrounded by impounding walls / bunds with a spillway to drain excess water to downstream fields. Once all fields in a series are filled, the water rejoins the natural watercourse. The catchment to application area (C:A) is commonly 10:1–100:1, it can reach 175:1. Through this system, rainfall runoff from bare or sparsely vegetated hilly or mountainous areas can be collected. The system is found in many semi-arid hill or mountainous regions with annual rainfall of 100–600 mm. It can be applied for many crops and fruit trees especially those that tolerate water-logging. In Pakistan this system is called sylaba / sailaba, in Somalia caag and in Turkmenistan takyr cultivation.

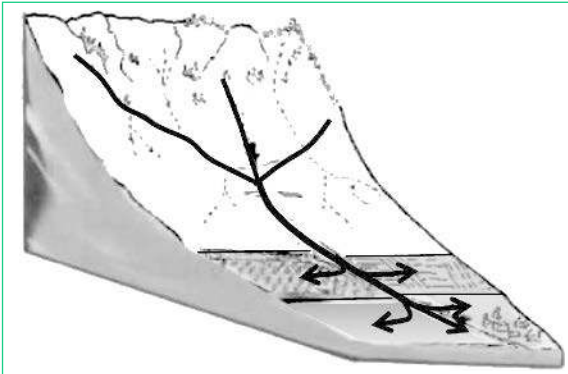

Hillside runoff system (Prinz, 2011)

**Limans** is a foothill reclamation technology. *Limans* are single structures at the foot of long slopes (1–10%), consisting of a bund of 1–3 m high around a cropping area. The size of the cropping area varies between 0.1–0.5 ha, while the catchment area can reach 200 ha. This technology is found where rainfall is as low as 100 mm and with very few rainfall events per year. It is used for fruit and forest trees and crops that are tolerant to waterlogging and at the same time withstand months of drought (e.g. for crops: sorghum, cowpea). In Israel trees planted in *limans* include eucalyptus, tamarisk, acacia, mesquite (*Prosopis*), pistachio, carob and date palm.

**Large semi-circular or trapezoidal bunds** consist of earthen bunds facing up the slope and are built in long staggered rows. These structures harvest runoff water from external catchments upslope and are used for annual and perennial crops as well as pastures. A trapezoidal bund consists of a base bund, connected to two side bunds at an angle of about 135° and a distance between the tips of 10–100 m. Overflow is discharged around the tips of the side bunds. The wings of the side bunds are preferably reinforced with stones. Often they are constructed using machinery. Enclosed areas can reach 1 ha in size (C:A 15:1–100:1). The technology is suitable for areas with 200–400 mm of annual rainfall. Crops are planted when the water trapped in the enclosed area subsides. This technology is relatively new. Semi-circular bunds are suitable for areas with an annual rainfall of 400 mm and hence the C:A ratio ranges between 15:1–40:1. In Tunisia large semi-circular bunds are also called *tabia*.

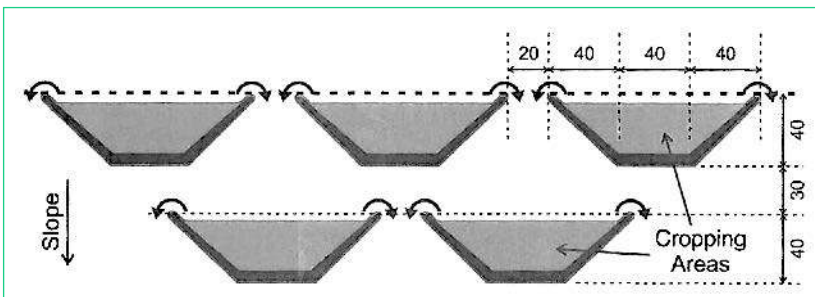

Layout of large trapezoidal bunds. Dimensions are in meters (Oweis et al., 2012 adapted from Critchley and Siegert, 1991).



Reconstruction of an ancient hillside conduit system in Wadi Advat / Negev, Israel. (D. Prinz)



Diversion of runoff water from different sources for growing high value crops such as vegetables and fruit trees practiced in Ethiopia and known as *korbe*. (D. Danano)



Hillside runoff system, Rajasthan India. (HP. Liniger)



View of a field improved through the implementation of semi-circular *tabias* in Tunisia. (H. Taamallah)

**Road runoff:** Sheet and rill runoff, generated from either compacted surfaces of roads, or channel flow through culverts, is diverted directly onto cropped land, or into storage structures such as ponds. When diverted directly onto fields, the water may be spread through reticulating channels, and the soil acts as the storage facility. However, when runoff is captured in ponds, it is pumped out and used for supplementary irrigation: this system is preferred for high value horticultural crops. Most road runoff systems are traditional, having been developed by land users themselves.



Road runoff harvesting system with macro- and microcatchments in Ethiopia. (HP. Liniger)

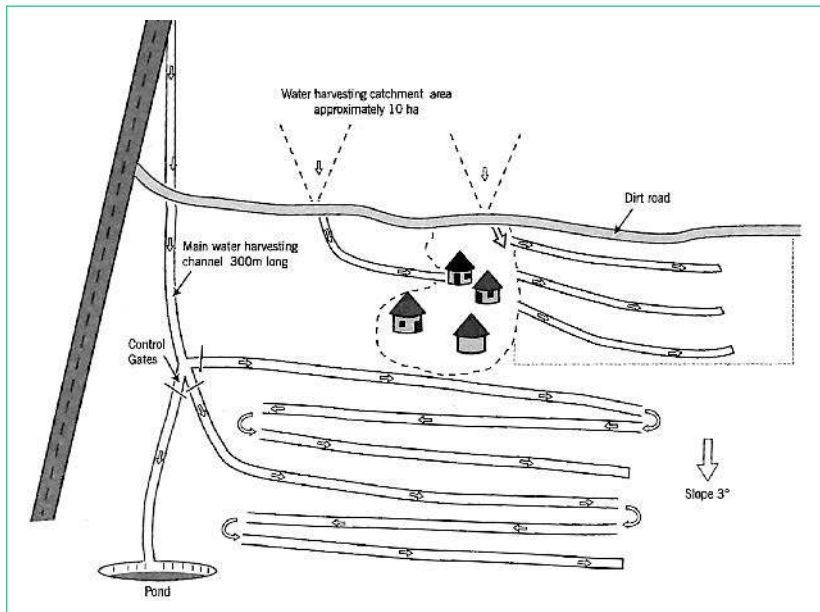

Plan of road runoff WH system, Mwingi district, Kenya (Mutunga and Critchley, 2001).



Gully reclamation in Faizabad, Tajikistan. (HP. Liniger)

**Gully plugging and / or productive gullies:** blocking of gullies by stone or earth check dams or vegetative barriers leads to the deposition of fertile sediments and organic matter, and the collection of water during heavy rainfall events. Such gullies can be planted with a variety of crops such as annual crops, fruit trees and fodder grasses. Apart from the benefits of increased productivity, the threat of further expansion of gullies and loss of land is mitigated.

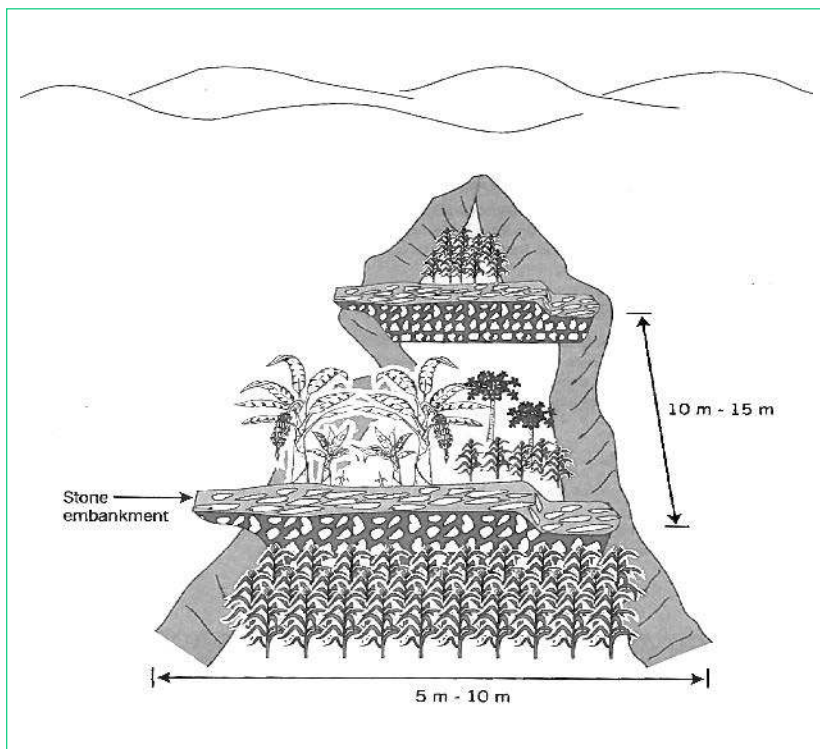

Stone embankments slow down runoff, encourage sedimentation of organically rich deposits and create a moist and fertile gully bed, suited to crop production. Bananas, pawpaws and annual crops are planted between the stone checks (Mutunga and Critchley, 2001)

### Example: Gully reclamation in Kenya

In eastern Kenya, a gully has been stabilised with stone and earth check dams by a farmer innovator: Mwaniki Mutembe. There are other examples also of similar local initiatives in the area. The check dams, each about 1 m in height, are spaced about 10 m apart in the gully. Makarikari grass (*Panicum coloratum* var. *makarikariensis*) helps in stabilisation of the check dams, while bananas and papaya are planted within the rehabilitated area in-between. When it rains, runoff generated from the neighbouring plots upstream flows down and is slowed by the check dams. The runoff passes over each embankment, filling and flowing through the enclosed sections of the gully bed. Fertile sediment and goat droppings are trapped. Excess runoff flows on to the second check dam, then through the second terrace bed and so on. Thus the gully heals slowly with time and vegetation becomes established. However regular maintenance work is required, involving repair of broken sections from time to time, using hand labour (Mutunga and Critchley, 2001; WOCAT 2012).



Mwaniki Mutembe's 'gully garden'. (W. Critchley)

**Cut-off drains:** A cut-off drain safely discharges runoff water to a waterway. From there water flows either into the natural drainage system or is harvested in storage facilities for further use. Cut-off drains are dug across a slope to intercept surface runoff and carry it safely to an outlet such as a canal or stream. Soil dug is heaped to a ridge below the trench, which acts as embankment protection in case of overtopping. It is suitable for all land uses; but often constructed between different slopes or land uses. Cut-off drains are mainly used to protect cultivated land, compounds and roads from uncontrolled runoff, and to divert water from gully heads. In dry areas they can act as infiltration and water retention ditches.

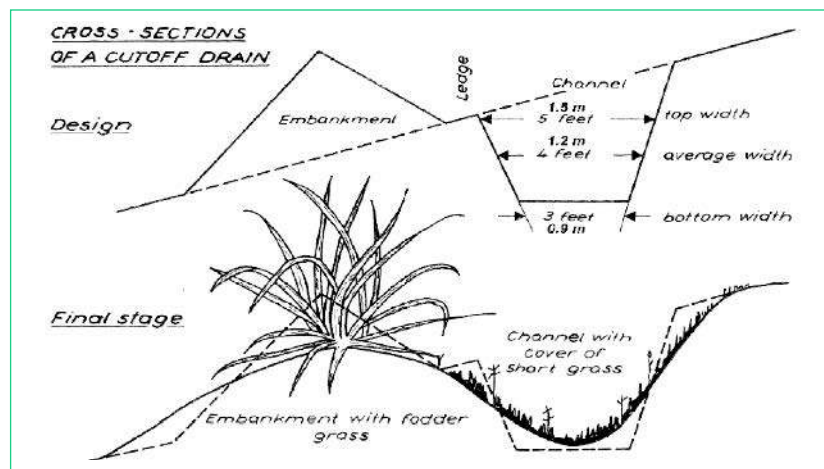

Cross-sections of a cutoff drain (Jaetzold and Schmidt, 1983).

## Water storage facilities

### Surface storage

#### Open ponds or pans

The terms ponds and pans are often used interchangeably; however, in general pans describe structures used by herders while ponds are used by farmers. They store runoff collected from cultivated hill slopes, grasslands, natural watercourses, gullies, roads, footpaths or cattle tracks. The stored water usually suffers from losses due to seepage and evaporation.

**Naturally occurring pans:** These form in depressions where rainwater accumulates during the rainy season and there is no outflow. They are best suited for livestock water although some people still use them for domestic supply. In West Africa they are known as *mare naturelle*.

**Excavated ponds** exist in many different sizes – from 200 to 500 m<sup>3</sup> for individual households – and up to 10,000 m<sup>3</sup> at the community level. They are often started with small capacity and are expanded over the years. Well-known examples are *hafirs* / *hafair* which consist of dugout enlargements of natural depressions in the savannah of Sudan, or *lacs collinaires* in Algeria, *madgen* in Morocco, *deeg* in Senegal, *charco* ponds in the drylands of Tanzania, *khaks* in Turkmenistan or *mahafurs* in north-west Arabia (Saudi-Arabia) which are commonly used for livestock consumption. Traditionally *hafirs* were developed and managed as livestock drinking troughs nowadays they can also provide water for irrigation or drinking water especially there were other water sources are not available. To reduce seepage the pond bottom can be compacted or lined with masonry, concrete or durable plastic sheets. In south-western China, water is collected from small streams in the rainy season and stored in small ponds to irrigate sugar cane, mulberry and tobacco crops. Once an upstream pond is full, the water flows to the next pond downstream and so on.

**Cultivated reservoirs / tanks** are above ground earthen water retention structures. Tanks are constructed on gentle slopes (1–10%) by excavating soil and/or building bunds (reservoirs). In this system collected water is either directed from the tank to lower fields or into a below ground tank or shallow well for irrigation (C:A ratio 10:1–100:1). When the water of the reservoir is used, the reservoir itself is cropped on soil residual moisture. This system is suitable for areas with 150–600 mm annual rainfall. It is well known as *khadin* and *ahar* in India and Sri Lanka and called *gawan* in Somalia, *khuskaba* in Pakistan or *teras* in Sudan. In India at the end of the monsoon the tank is emptied of the remaining water by a spillway and sluice gates to cultivate wheat and chickpeas with the remaining moisture. *Ahars* are often built in series. A major limitation is the siltation of the cultivated area in erosion prone areas.



Water pan in Haiti. (J. Zähringer)



Naturally occurring pans in dry river bed in Embu, Kenya. (HP. Liniger)

#### Example: *Hafirs* for livestock consumption in Sudan

*Hafirs* are rectangular or semi-circular tanks / reservoirs used to store water for both human and livestock populations. They are popular in Sudan and South Sudan, where sizes vary from 15,000 m<sup>3</sup> to 100,000 m<sup>3</sup>. Recently, attempts have been made to standardize the size for uniformity: 30,000 m<sup>3</sup> in Sudan and between 10,000 to 30,000 m<sup>3</sup> in South Sudan. *Hafirs* need fencing and protection to minimize pollution and hygiene hazards. An 'improved *hafir*' is a *hafir* with a water treatment system that provides improved drinking water primarily for human consumption.



Excavated pond (improved *hafir* system) with water pump and sedimentation tank. (Ministries of Water Resources and Irrigation of Sudan and South Sudan, 2009)



**Sunken streambed structures** (called *doh* in India) are rectangular excavations in seasonal streambeds, which are intended to capture and hold runoff to enhance groundwater recharge, thus increasing water for irrigation from nearby shallow wells. *Dohs* are built in semi-arid areas where rainfall is low and seasonal. The dimension of a typical *doh* is 1.0–1.5 m deep with variable length (up to 40 m) and width (up to 10 m) depending on streambed section, with an average capacity of 400 m<sup>3</sup>. *Dohs* are generally built in sequence. They may be as close as a few metres apart. The technology is used in conjunction with shallow wells (*odees*), which enable farmers to harvest the increased groundwater for supplementary irrigation of annual crops – including vegetables such as chilli peppers. Water is pumped out of the wells.

**Ponds for groundwater recharge:** These man-made depressions fill with runoff water and eventually feed underground freshwater “lenses” floating on top of the saline aquifer (e.g. *tajamares* in Uruguay and Paraguay, *chirle* in Turkmenistan). Water pumps are used to pump the water back up to the surface. The water is used for livestock consumption and domestic use after filtration and/or chlorination but also serves to artificially recharge groundwater aquifers. Artificial recharge through infiltration ponds can be applied almost anywhere, provided that there is a supply of clean fresh water available at least part of the year, the bottom of the pond is permeable, and the aquifer to be recharged is at or near the surface.

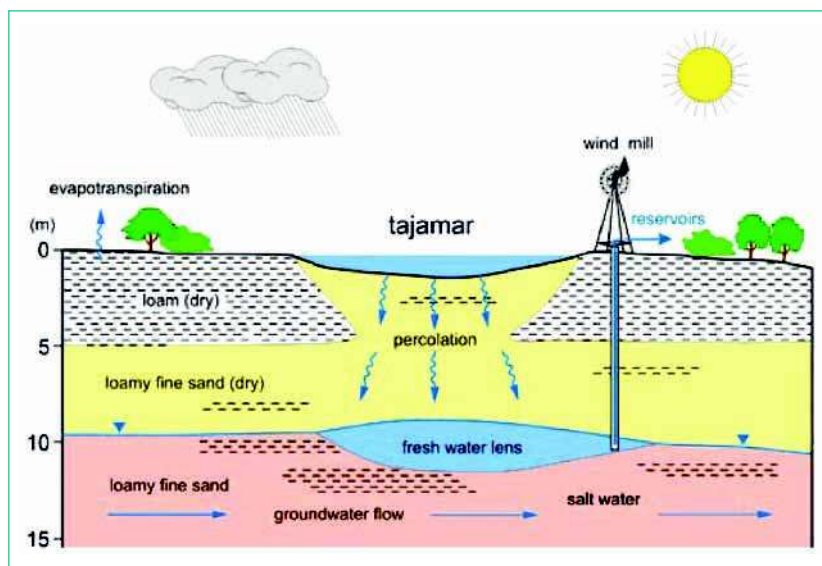

*Tajamares* (Van Steenberg and Tuinhof, 2009).

In Bangladesh fresh water bubbles (in brackish groundwater) are created through infiltration wells by infiltrating pond water and rainwater below the clay layer into the shallow aquifer. This fresh water is used for domestic purposes during the dry season. In South Africa dune infiltration basins are used to enhance natural groundwater recharge for drinking water supply and protection of fresh groundwater reserves against intrusion of saline water. Basins were either excavated or formed through dams retaining the water until it has infiltrated through the basin floor. In Niger oasis vegetable garden irrigation was rehabilitated by lifting the groundwater table using a low ridge dam (*barrage*) and an infiltration basin. Low floods in the *kori* Tamgak (Iférouane) are diverted to the infiltration basin. (Van Steenberg and Tuinhof, 2009).



A series of *dohs* temporarily filled with runoff water before infiltration. (D. Gandhi)



*Tajamar* in Uruguay. ([www.agrogestion.com.uy](http://www.agrogestion.com.uy))



Small earth dam with sedimentation trap in Kenya. (HP. Liniger)

**Example: Small dams (*ndivas*) in Tanzania**

In the 300 km<sup>2</sup> large Makanya catchment in Tanzania, about 75 small dams called *ndivas* have been identified. These are established along the upper section of main irrigation canals and have a storage capacity of between 200 and 1,600 m<sup>3</sup>. They are used to temporarily store water when nobody irrigates. During the period of irrigation, the water from the *ndivas* is used to boost the furrow irrigation as the water available from the canal is not sufficient to reach the most distant farmers. Many of these reservoirs have a relatively long history, and were established by local clans. Over the years, most reservoirs have been enlarged to serve increasing areas of irrigation. Farmers have also been assisted with lining these dams to reduce the seepage losses (Mul et al., 2011).

## Surface dams

**Small earth and stone dams:** Rainwater storage systems such as small dams in Ethiopia and Tanzania (known as *ndivas*), are communally constructed around foot-slopes of hills or along irrigation canals to store the runoff from ephemeral or perennial rivers. The reservoirs have neither plastered walls nor covered surfaces. The water is mostly used communally for livestock consumption, and for supplementary irrigation. *Ndivas* are suitable for areas with 300–600 mm of rainfall.

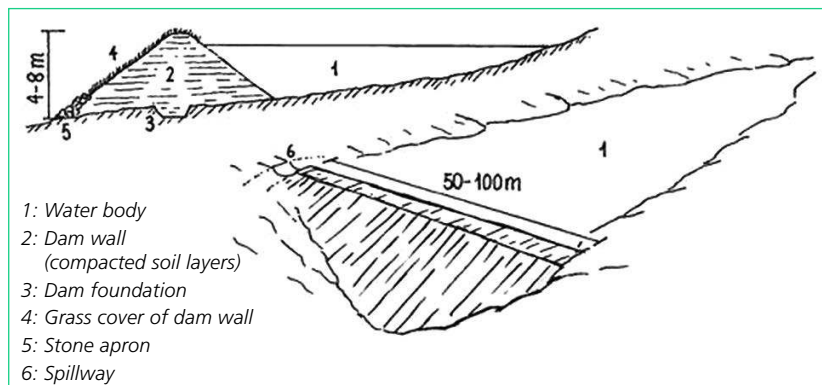

Small earth dam (M. Gurtner in Liniger et al., 2011).

**Check dams:** A raised wall is constructed using stone, concrete and gabion across a gully to pond/store the stream flow behind it for irrigation purpose (using either gravity or lifting mechanism) and reducing the runoff velocity and enhancing gully rehabilitation. The width of the dam wall ranges between 1–2 m while the height varies between 2–4 m depending upon the gully depth. The length of the check dam depends on the gully width while the spacing between adjacent check dams is determined based on the availability of water and a potential land that can be irrigated. The gully area needs to be well protected against further erosion. Otherwise the dam will be filled with sediments and converted into a productive gully (see above).

**Rock catchment masonry dams:** These dams are common practice in several countries in Sub-Saharan Africa. In the case of large rock catchments, cement and stone gutters are used to extend the catchment area to gather runoff from a several-hectare sized catchment. The storage structure is either a dam or a tank situated adjacent to a rock catchment. The reservoir should have a relative high depth to surface ratio to minimize evaporation. A major advantage of rock catchment systems is that there is little water loss through seepage. Water collected in rock catchment dams is often extracted for domestic and livestock consumption or supplementary irrigation.

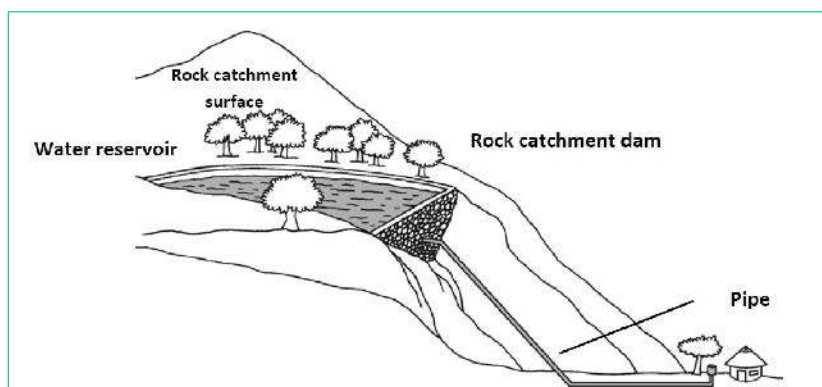

Rock catchment dam (UNEP IETC, 1998 in Clements et al., 2011).



Earth dam in Loess Plateau, China. (HP Liniger)



Check dam made of stone, concrete and gabion for irrigation purpose at the same time reducing the runoff velocity and enhancing gully rehabilitation. (E. Yazew)



Small check dam, Rajasthan India. (HP Liniger)



Rock catchment dam in Kitui, Kenya. (HP Liniger)

### Example: Rock catchments in Kenya

Several hundreds of rock catchment dams have been built by the Agricultural Services and a number of NGOs in Kitui, within Eastern Kenya since the 1950s. The rock catchment dams in the region have a wide range of storage capacities (20–4,000 m<sup>3</sup>), and are primarily used for domestic purposes. However, they can also be used for small-scale irrigation in vegetable gardens. It has been observed that the local communities prefer rock catchments over any other form of water supply (except rooftop water harvesting), because maintenance is simple and cheap, and rock catchments do not occupy farmland (Nissen-Petersen, 2006b).

## Subsurface storage

### Groundwater dams / retention weirs

Groundwater dams obstruct the flow of groundwater and store water below ground level and replenish the wells upstream of the dam. There is a wide variety of different types of ground water dams also called retention weirs:

**Subsurface dams** are built entirely underground into sandy riverbeds of seasonal water courses and founded on impermeable bedrock to intercept groundwater flow. They are impermeable barriers (clay, masonry or concrete) obstructing subsurface flow. Groundwater can be abstracted through wells, boreholes or a collector drain. Typical small dams have a storage capacity of some 10,000 m<sup>3</sup> (average 4 m depth, 50 m width and 500 m length). Larger dams may be 5–10 m in depth, have a width of 200–500 m or more, and be able to store 100,000–1,000,000 m<sup>3</sup>. Several dams built in a cascade increase the total groundwater volume stored and limit the effects of leakage. Sub-surface dams reduce variation in the level of the groundwater table upstream of the dam. They are found in many countries in different sizes and numbers.

**Sand dams** are larger than subsurface dams and weirs as they can be raised to several meters above ground in sandy riverbeds. Coarse sand carried by the flow is deposited upstream of the dam and gradually fills the streambed while lighter material is carried over it in periods of high flow. Water is stored within the porous space of the deposited coarse sand. This artificial aquifer increases in thickness over time. Additionally, the sand reduces evaporation and contamination of the water in the sand body behind the dam rendering the water suitable for livestock, domestic supply or small-scale irrigation.

**Percolation dams** do not block ground water flow as the previous systems. They serve three purposes: (a) to reduce the speed of surface flow; (b) increase percolation for the recharge of shallow aquifers; and (c) obstruct the flow of sediments. They are constructed across riverbeds, natural drainage channels and gullies. Simple check dams are made of natural materials that are locally available such as rocks, logs, bamboo, sticks and branches. More sophisticated dams are constructed using rocks and steel rods (gabion). Concrete is used for making permanent check dams but the foundation of the dam wall does not reach the impermeable layer. Crops are irrigated by pumping water from recharged wells. In Thailand they are used for reforestation.

**Subsurface dams, sand dams and percolation dams** can be combined. The storage volume can be increased by raising the dam wall above the surface, thus causing additional accumulation of sediments. Ideal riverbeds for the construction of such groundwater dams consist of sands and gravel, with rock or an impermeable layer at a few metres depth. Preferably, the dam should be built where rainwater from a large catchment area flows through a narrow passage. Such underground reservoirs can be filled by a single flash flood. Once saturated, the remaining water will pass over the dam and replenish downstream aquifers. Water is extracted for use either manually from wells or with motorized pumps.

### Subsurface reservoirs or cisterns

Cisterns are subsurface water reservoirs / storage tanks. Their capacity ranges from 10–1,000 m<sup>3</sup>. In many areas small cisterns are dug in the rock. Larger cisterns are lined with compacted earth, clay, mortar coating, concrete or plastic sheets to avoid seepage. Runoff is collected from an adjacent catchment or channelled from a distant catchment. They are either dug below a solid rock layer or covered to reduce



Dry (above) and flooded (below) subsurface dam in Kenya. (E. Nissen-Peterson).

### Example: Subsurface dams in Brazil

About 500 small subsurface dams were constructed in the state of Pernambuco in north-eastern Brazil in the 1990s. An evaluation of around 150 showed that such dams significantly improved the variety and quality of food crops produced. They also had an important role in livestock watering and in the provision of dry season animal fodder (Foster and Tuinhof, 2004).



Fully filled sand dam in the Nzyaa Muysio valley in Kenya. (P. Braden)

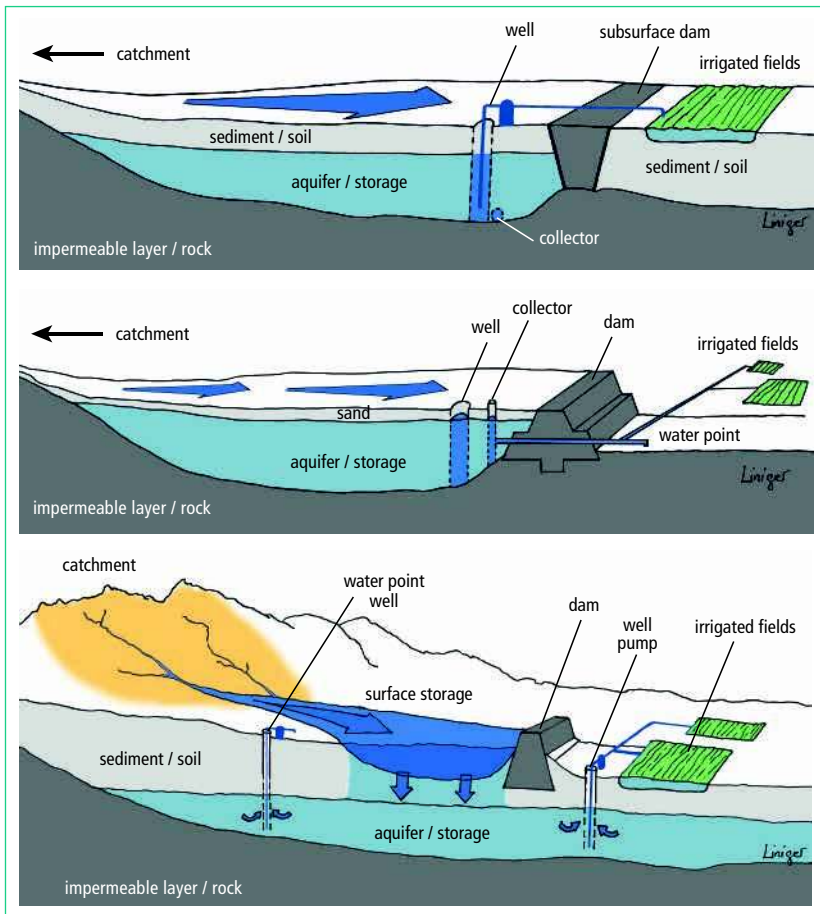

Longitudinal section of (top) a subsurface dam, (middle) a sand dam and (bottom) percolation dam (adapted from Foster and Tuinhof, 2004; Oweis et al. 2012).

evaporation. In most cases, stilling basins (sedimentation traps) are attached in front of the inlet to reduce sedimentation: otherwise regular cleaning of the cistern is required. When larger storage volumes are needed, two or more structures can be built in the same location. The cisterns under the MacroWH group are mainly used for animal consumption and irrigation but also for community drinking water also depending on water quality attained. Large community cisterns can store up to 80,000 m<sup>3</sup> of water. Concrete or ferro-cement lined subsurface tanks are known as *berkas* in Somaliland. In Turkmenistan underground tanks built of lime mortar and bricks with a covering dome are called *sardobs*. In Gansu, China they are called 'water cellars' and in Morocco *matfia* or *joub*.

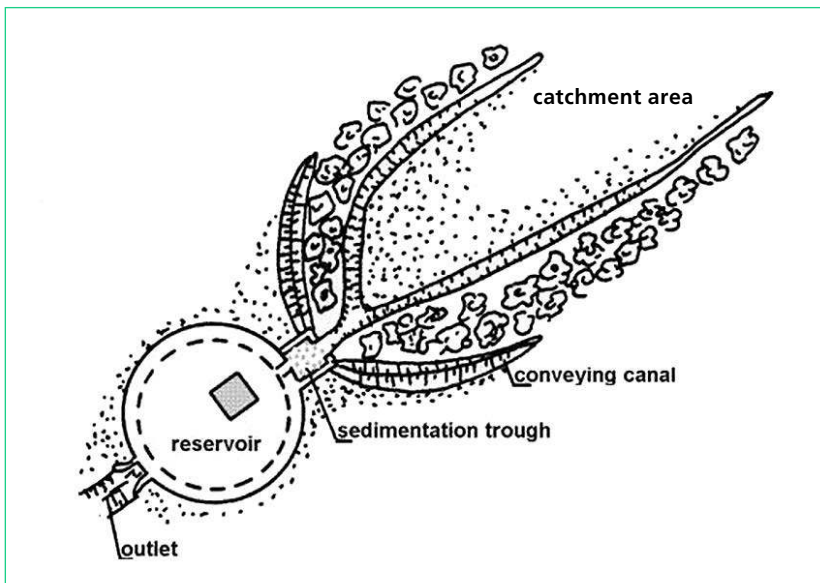

Technical drawing of a cistern in Tunisia (M. Ouessar in WOCAT, 2012).



Sand dam Embu, Kenya. (HP. Liniger)



Water accumulating in front of a percolation dam recharging nearby wells, Argentina. (HP. Liniger)

**Example: Cisterns in Tunisia**

Many small and big, private and communal cisterns, mainly built during the Roman and Arab-Muslim eras, can be found throughout the arid zones of Tunisia. They increase the availability of water for multipurpose use (drinking, animal consumption, supplementary irrigation) in remote areas. A cost-benefit analysis showed that the stored water has high potential for improving the farming system and incomes of jessour-based agriculture (M. Ouessar in Taamallah et al., 2010).



Cistern in Tunisia. (M. Ouessar)



Cistern in Jordan. (HP. Liniger)

## 'Traditional' wells

**Horizontal wells:** This around 2500 year old water harvesting technology of "horizontal wells" originated in Iran. It consists of gently sloping subterranean tunnels dug far enough into alluvium or water-bearing sedimentary rock to pierce the underground water table and penetrate the aquifer beneath. Water from the aquifer filters into the upper reaches of these channels, flows down their gentle slopes, and emerges as a surface stream of water at, or near, a settlement. Horizontal wells are generally constructed on the slopes of foot zone alluvial fans, in intermontane basins, along alluvial valleys that lack large rivers with year-round flows sufficient to support households and irrigation. They are common in arid areas with high evaporation rates where potentially fertile areas are close to precipitation-rich mountains and where underground springs are common. Water channelled to villages or farmland using gravity saves labour as compared to obtaining water from dug wells using manual labour. Rehabilitation and maintenance of these systems need great knowledge and skills. The technology goes by different names: *faladsch / aflaj* (United Arab Emirates and Oman), *foggara* (North Africa), *galerias* (Spain), *kanjering* (China), *karez* (Afghanistan, Paksitan), *qanats* (Syria, Jordan), etc.

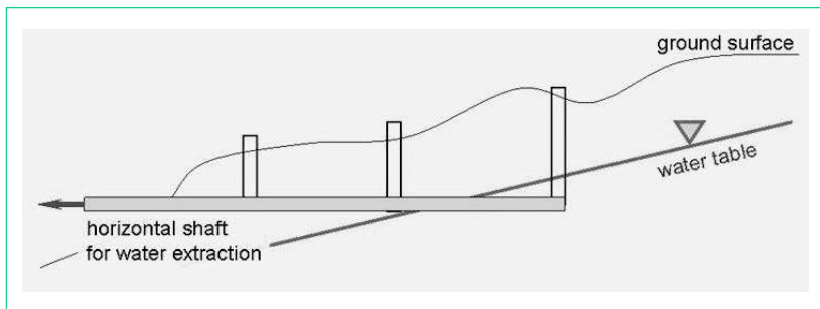

Description of a *qanat* system: Vertical shafts called mother wells (up to 50 metres deep) are dug close to underground springs or water table. Further, several and at more or less regular intervals "ventilation shafts" are dug in a straight line to target (Safriel and Adeel, 2005).

**Recharge wells:** Recharge or injection wells are used to directly recharge water into deep aquifers. Recharge wells are suitable only in areas where a thick impenetrable or slowly permeable layer exists between the soil surface and the aquifer. A relatively high rate of recharge can be attained by this method. To avoid clogging of the well regular maintenance is needed. The recharged groundwater can be accessed by wells and boreholes tapping the same aquifer or feeding natural springs.

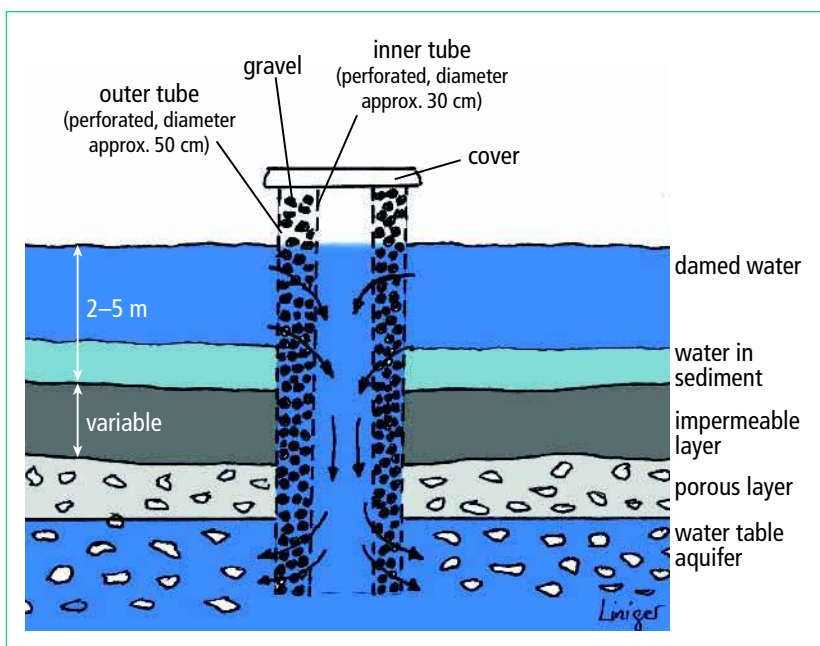

Component of a recharge well.



Aerial view of a *qanat* system in Iran with the access shafts forming a trail towards a village. (www.livius.org)



Surfacing of a *foggara*. (French Wikipedia)

### Example: Recharge well in Tunisia

In Tunisia, recharge wells are used in combination with gabion check dams to enhance the infiltration of floodwater into aquifers in areas where surface water cannot reach the aquifer because of an impermeable (or slowly permeable) layer. Recharge wells are installed in *wadi* (ephemeral river) beds. A recharge well consists of a long inner tube surrounded by an outer tube, the circumference of which ranges between 1 and 2 m. The area between the tubes is filled with river bed gravel which acts as a sediment filter. Water enters the outer tube through small openings (20 cm long, a few mm width) and flows through the gravel and the perforated inner tube. From there it reaches the aquifer. The above-ground height of the well is around 2 to 3 m while the depth is linked to the depth of the water table (normally up to 40 m) (M. Ouessar and H. Yehyaoui in Schwilch et al, 2012).



Example of a recharge well behind a gabion check dam after rain. (M. Ouessar).

## Spread and applicability

### Spread

**Hillside runoff:** Middle East (e.g. Israel), Central Asia (e.g. Turkmenistan), Pakistan, North Africa, Mali, Mauritania, Somalia, Sudan.

**Limans:** e.g. Kyrgyzstan, Morocco, Israel, Tunisia.

**Trapezoidal and semi-circular bunds:** parts of North Africa (e.g. Tunisia) and sub-Saharan Africa (e.g. Burkina Faso, Kenya, Niger, Somalia).

**Road runoff:** e.g. Brazil, China, East Africa (e.g. Ethiopia, Kenya), Morocco.

**Gully plugging / productive gullies:** e.g. Bolivia, Ethiopia, Haiti (*jardin ravines*), India, Kenya, Morocco, Nepal, Nicaragua, Tajikistan, Tanzania.

**Ponds:** worldwide;

- **Hafirs:** Savannah belt of Africa (e.g. Ethiopia, Kenya, Morocco); Sudan; Middle East (rural Bedouin communities: e.g. Jordan);
- **Cultivation reservoirs / teras:** India and Sri Lanka, Pakistan, Somalia, Sudan;
- **Infiltration ponds:** e.g. Bangladesh, Niger, Paraguay and Uruguay, South Africa.

**Surface dams:** worldwide; East Africa (e.g. Burundi, D.R. Congo, Ethiopia, Kenya, Somalia, Sudan, Tanzania, Uganda, Zambia), Southern Africa (e.g. Botswana), West Africa (e.g. Burkina Faso, Senegal), Latin America (e.g. Brazil, Paraguay, Peru), Asia (e.g. China, India), Israel, etc.

**Groundwater dams:** worldwide;

- **Subsurface dams:** East Africa (e.g. Ethiopia, Kenya, Tanzania);
- **Sand dams:** examples are found throughout the semi-arid regions, highest concentration found in Kenya, also found in Angola, South Africa, Sudan, Uganda, Zimbabwe, as well as in Japan, India, Thailand, SW USA and Brazil.
- **Percolation dams:** widely used in Saudi Arabia, United Arab Emirates and Oman, also in Egypt, India, Jordan, Peru, Sudan, Syria, Thailand, Yemen.

**Cisterns:** North Africa (e.g. Egypt, Libya, Morocco, Tunisia), Middle East (e.g. Jordan, Syria, Yemen), Eastern and Southern Africa (e.g. Botswana, Ethiopia), Asia (e.g. India), Latin America (e.g. Brazil).

**Horizontal wells:** Asia (e.g. Afghanistan, China, India, Iran, Iraq, Jordan, Pakistan, Syria), Arabian Peninsula (e.g. Oman, United Arab Emirates), North Africa (e.g. Algeria, Egypt, Libya, Morocco, Tunisia), Europe (e.g. Spain – Canary archipelago, Italy, Greece).

**Recharge wells:** North Africa (e.g. Tunisia), East Africa, India, etc.

### Applicability

**Land use:** The catchment area can be located on rangeland or forest and occasionally also on cropland land. Water is applied mainly on cropland or mixed land use (e.g. agroforestry).

**Water use:** MacroWH is often aimed at providing water for domestic and livestock consumption. Small-scale supplementary irrigation is used for trees and field crops. Watering vegetables in small gardens is also common.

**Climate:** MacroWH systems are usually applied in semi-arid systems where it is necessary to store water to bridge the dry season or to mitigate the impact of dry spells. In comparison to microcatchments, macrocatchments are suitable for areas where few runoff events are expected – because a relatively larger amount of water can be captured per runoff event.

**Terrain:** MacroWH is often situated in small ephemeral riverbeds and natural or man-made depressions.

**Scale:** Dams can provide water for several communities, and their management as well as their impacts have to be considered at the watershed scale. Small ponds and cisterns can be managed at the household level.

**Level of mechanisation:** Depending on the size and capacity of the storage structure, construction involves either manual labour or heavy machinery, or a combination.

#### Land use

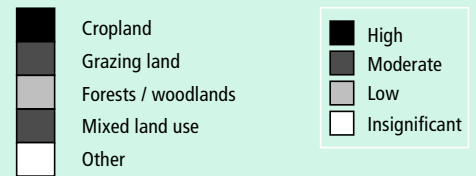

#### Water use

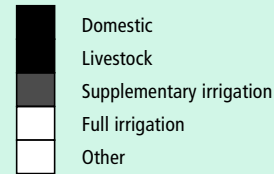

#### Climate

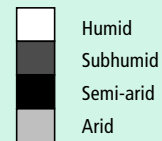

#### Average rainfall (mm)

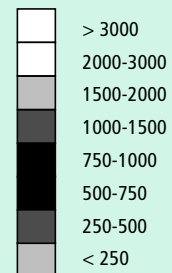

#### Slope of catchment (%)

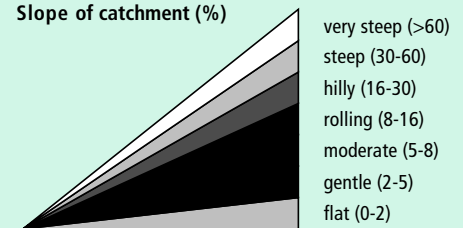

#### Scale

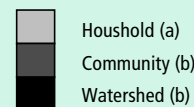

#### Land ownership

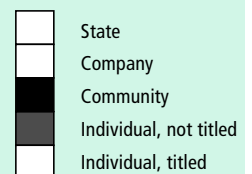

#### Mechanisation

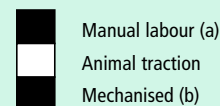

#### Market orientation



#### Required labour

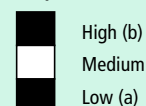

#### Required know-how



- a) ponds and pans  
b) dams, weirs

**Land ownership and land / water use rights:** For the establishment of MacroWH structures at the community or watershed scale, communal land ownership has to be secured and water use rights clearly defined. In the case of smaller structures land ownership is often individual and titled.

**Skill / knowledge requirements:** While small ponds and pans do not require detailed technical knowledge for construction and maintenance, larger structure, or more sophisticated wells and masonry or concrete dams do. Technicians have to be involved in the construction of such structures.

**Labour requirements:** Dams, retention weirs and horizontal wells have very high and skilled labour requirements.

#### Labour requirements for the construction of a sand dam, Ethiopia

Number of workers	Number of days per person	Total no. of days
4 masons	45.8	183.3
10 mason assistants	31	310
15 community workers	50	750

(adapted from RAIN, 2009)

#### Costs of labour for gully plugging

Country	Establishment costs US\$/ha	Maintenance costs US\$/ha/year
Nepal	2,925	70
Bolivia	110	16

(Liniger and Critchley, 2007 and WOCAT, 2012)

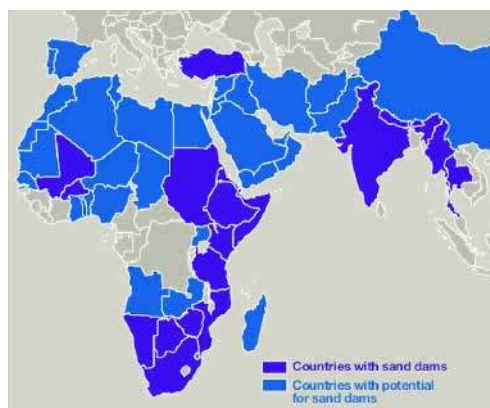

Actual and potential distribution of sand dams.  
([www.excellentdevelopment.com](http://www.excellentdevelopment.com))



Labour and technical staff discussing aspects of bund construction in a watershed south-east of Tunisia. (C. Hauser)

## Economics

### Costs

#### Establishment cost of selected MacroWH practices

Technology	Country	Indicative costs in US\$
Trapezoidal bunds	Kenya <sup>1</sup>	700 – 1,000 per ha
Ponds	Kenya <sup>1</sup>	1.3 per m <sup>3</sup> (maintenance 0.27)
Ponds plastic lined	Ethiopia <sup>1</sup>	1.5 per m <sup>3</sup> (maintenance 0.47)
Sunken streambed structure ( <i>doh</i> )	India <sup>2</sup>	200 – 400 per structure
Infiltration ponds ( <i>tajamares</i> )	Paraguay <sup>3,4</sup>	4,500 per structure <sup>3</sup> 25,000 per structure (for 400 persons) <sup>4</sup>
Infiltration pond & well	Bangladesh <sup>4</sup>	7,500 per structure
Earth dam (10,000 m <sup>3</sup> )	Zambia <sup>2</sup>	5 per m <sup>3</sup>
Subsurface dam	Brazil <sup>5</sup>	0.5 – 2 per m <sup>3</sup>
Subsurface clay dam	Kenya <sup>1</sup>	0.42 – 1,60 per m <sup>3</sup>
Subsurface dam	India <sup>5</sup>	0.13 per m <sup>3</sup>
Water spreading weirs	Sahel <sup>4</sup>	20,000 – 70,000 per structure
Water retention weirs	India <sup>6</sup>	2,660 per ha
Sand dams (various)	Kenya <sup>1</sup>	10 – 25 per m <sup>3</sup> 1.82 per m <sup>3</sup>
Masonry sand dam	Kenya <sup>7</sup>	0.71 per m <sup>3</sup>
Rock catchment masonry dam	Kenya <sup>8</sup>	46 – 110 per m <sup>3</sup>
Gully plugging	India <sup>4</sup>	90 per ha
Vegetative gully check dam	Tajikistan <sup>2</sup>	20 per structure
Water tank (30 m <sup>3</sup> )	China <sup>9</sup>	6 per m <sup>3</sup>
Surface WH tanks	Ethiopia <sup>4</sup>	290 – 1,500 per structure
Recharge well	Tunisia <sup>10</sup>	5,000 – 10,000 per structure

<sup>1</sup> Knoop et al., 2012; <sup>2</sup> Liniger and Critchley, 2007; <sup>3</sup> Clements et al, 2011; <sup>4</sup> Tuinhof et al., 2012;

<sup>5</sup> Van Steenberg and Tuinhof, 2009; <sup>6</sup> Van Steenberg et al., 2011; <sup>7</sup> RAIN 2009;

<sup>8</sup> African Development Bank, 2009; <sup>9</sup> Wu et al, 2009; <sup>10</sup> Schwilch et al., 2012

### Production benefits

#### Yield increase with MacroWH

Crop	MacroWH	Country	Yield without MacroWH <sup>1</sup> (t/ha)	Yield with MacroWH <sup>1</sup> (t/ha)	Yield gain (%)
Maize (grain yield) <sup>1</sup>	Earth dam	Kenya	1.38	1.80	30
Sorghum <sup>2</sup>	Contour bunds and trenches	India	1.75	2.40	137
Vegetables <sup>2</sup>	Contour bunds and trenches	India	5.00	7.00	140
Cotton <sup>2</sup>	Contour bunds and trenches	India	0.70	1.13	160

<sup>1</sup> For both treatments 30/80 kg N/ha fertilizer was applied. Without fertilizers, irrigation from the earth dam did not significantly increase crop yield (Barron and Okwach, 2005; WOCAT, 2012); <sup>2</sup> (WOTR, not dated).

#### Costs of MacroWH per structure (median)

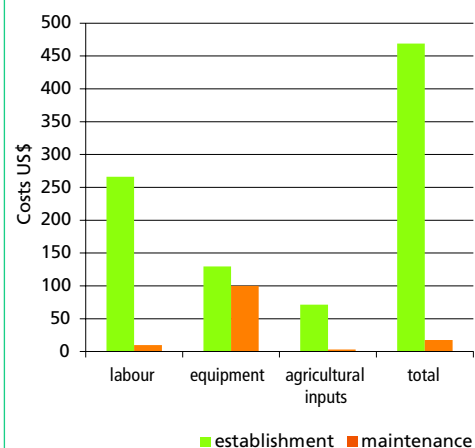

Costs for MacroWH are highly variable from US\$ 21 for a vegetative gully plug in Tajikistan to US\$ 94,000 for water impounding structures in the Philippines.

Source: 13 case studies (WOCAT, 2012).

#### Example: Earth dams for supplementary irrigation in Burkina Faso and Kenya.

The economic viability of constructing an earth dam for supplementary irrigation of a staple crop (sorghum) and a fully irrigated off-season crop (tomato) was modelled for study sites in Burkina Faso and Kenya. Earth dam establishment resulted in a net profit of 151: 626 US\$/y/ha for the Burkina case and 109: 477 US\$/y/ha for the Kenya case depending on opportunity cost of labour, compared to 15: 83 US\$/y/ha for the Burkina case and 40: 130 US\$/y/ha for the Kenyan case for current farming practices. The results further showed that while the system is labour-intensive it is a risk-reducing investment. The production system needs to be combined with a cash crop grown during winter season in order to provide a secure strategy for food self-sufficiency. The analysis further suggested a strong mutual dependence of investment in water harvesting and fertilizer input. Neither might not be viable if applied alone (Fox et al., 2005).



Banana production next to sand dam, Kenya. (excellent development)



## Benefits

### Sand storage dams Kitui, Kenya

A sand dam provides about 1,500–2,000 m<sup>3</sup> of stored water during a rainy period. On an average, 25 families or about 150 persons use a dam. The access to water was improved, thus time for fetching water was reduced. Hence, agricultural and industrial production increased and resulted in more income. For one sand dam (25 families) the net increase in family income was US\$ 3,000/y (Tuinhof et al., 2012).

Benefits: comparing 1995 and 2005	Without dam		With dam	
	1995	2005	1995	2005
Access to drinking water dry season	4 km	4 km	3 km	1 km
Domestic water use	136 l/day	117 l/day	61 l/day	91 l/day
Number of people exposed to drought	600	600	420	0
Households with irrigated crops	38%	38%	37%	68%
Agricultural water	160 l/day	110 l/day	220 l/day	440 l/day
Brick and basket production	0 US\$/y	0 US\$/y	21 US\$/y	63 US\$/y
Household incomes	21 US\$/y	21 US\$/y	21 US\$/y	336 US\$/y

(Lasage et al., 2008 in Tuinhof et al., 2012)

### Ponds for groundwater recharge: *Tajamares Chaco, Paraguay*

The *tajamar* systems provide a water source under very difficult conditions. A *tajamar* with a volume of 30,000 m<sup>3</sup> provides drinking water for up to 1,200 persons. *Tajamar* water price is calculated based on the material costs. With an interest rate of 5% and a life time of 15 years a water price of 0.1 US\$ per m<sup>3</sup> was estimated as compared to 2.23 US\$/m<sup>3</sup> market price of water. The labour needed for construction and maintenance is in-kind and contributed by the communities themselves. Apart from providing drinking water, *tajamares* enable livestock farming in Chaco. Depending on the irrigation intensity of the pasture, the production rate is between 1 to 1.5 cattle per hectare. According to the *Asociación Rural de Paraguay (ARP)* the additional water available (apart from what's needed for irrigation) contributed to an increase of 36% in livestock farming between 2005 and 2010. Furthermore growing of vegetables became possible. The economic growth in Chaco had a strong effect on the labour market, which related directly to farming activities but also to agricultural processing in Chaco. Indigenous people benefitted most as they were disproportionately faced with water shortage (Tuinhof et al., 2012).

### Example: Groundwater recharge ponds, Turkmenistan

In Turkmenistan the cost of *chirles* (groundwater recharge ponds) vary considerably. When only one well for human consumption is in use, the structure costs US\$ 2,500. When ten wells are dug, the cost per pond decreases to US\$ 2,100. In case the wells are also utilized for livestock water or to improve the rangeland the cost rises to US\$ 3,650. Despite the first investment, maintenance costs are relatively low at US\$ 115–192 per year. The costs are usually shared by many households and the community maintains the *chirles* (Van Steenberg et al., 2011).

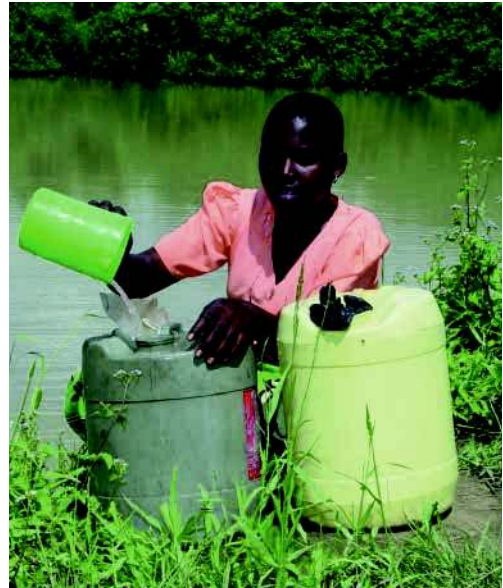

Young girl fetching water for domestic use from a small dam. (M. Malesu)



Water for animals removed from a well next to a sand dam, Samburu, Kenya. (HP. Liniger)

Impacts		
Benefits	Farm level / household level	Community / watershed / landscape level
Production / Economic	<ul style="list-style-type: none"> <li>+++ increased water supply for irrigation of small vegetable plots and tree nurseries</li> <li>+++ increased crop yield</li> <li>+++ increased water availability for livestock</li> <li>+++ increased irrigation water availability</li> <li>++ increased drinking water supply</li> <li>++ increased farm income</li> <li>++ increased fodder production</li> <li>++ reduced demand for surface and groundwater</li> <li>+ diversification of farm activities (e.g. raising ducks, geese and fish, brick making)</li> </ul>	<ul style="list-style-type: none"> <li>+++ downstream users not deprived as water only fills up behind the dam created when flow is abundant<sup>a</sup></li> <li>++ additional land brought into production</li> <li>++ reduced risk of crop failure</li> <li>++ increasing the value of land near a macro catchment structure</li> <li>+ increased diversification in production</li> </ul>
Ecological	<ul style="list-style-type: none"> <li>+++ increased soil moisture</li> <li>+++ enhanced groundwater recharge</li> <li>++ rehabilitation of highly degraded land</li> <li>++ reduced surface runoff</li> </ul>	<ul style="list-style-type: none"> <li>+++ increased resilience to climate change</li> <li>++ protecting watercourses from sedimentation<sup>a</sup>)</li> <li>++ reduced soil erosion from flood events</li> <li>++ sediment trap for nutrients</li> </ul>
Socio-cultural	<ul style="list-style-type: none"> <li>+++ reduced periods of drinking water shortage</li> <li>+++ reduced time for fetching water for domestic use</li> <li>++ improved conservation / erosion knowledge</li> </ul>	<ul style="list-style-type: none"> <li>+++ improved food and water security</li> <li>++ reduced water conflicts due to greater availability</li> <li>++ community institution strengthening</li> <li>++ improved situation of socially and economically disadvantaged groups</li> <li>+ attractive landscape</li> </ul>
Offsite		<ul style="list-style-type: none"> <li>+++ reduced downstream flooding and damage to fields and infrastructure</li> <li>++ rivers and reservoirs protected from sedimentation</li> </ul>

Importance: +++ high, ++ medium, + low

	Constraints	How to overcome
Production / Economic	reduced amount of water for downstream users can be a problem for some structures such as larger dams	→ management schemes including up- and downstream users have to be set-up
	seepage is a major problem in water storage in earthen reservoirs, accounting for losses up to 70% of the harvested water	→ good quality material and technical knowhow for lining of earthen reservoirs
	for the establishment of certain types of dams and artificial ponds high inputs are a constraint	→ microcredit facilities
	loss of productive land can be a constraint for small farms with a MacroWH structure	
	water quality can be a problem, especially because livestock very often use the same water point as humans <sup>b</sup>	→ provide adequate information and campaign for water treatment methods including solar disinfection, boiling or chlorination
	increased risk of spread of vector-borne diseases	→ improve spread of prevention measures e.g. through mosquito nets
Ecological	reduced amount of downstream water may disturb ecological systems	→ conduct environmental impact assessments
Socio-cultural	risk of conflicts between different land users (e.g. pastoralists, crop producers) due to lack of defined ownership of water sources, lack of clear by-laws for water users associations, corrupt water management committees etc.	<ul style="list-style-type: none"> <li>→ capacity building programs targeting both users and management committees to strengthen ability to deal with conflicts</li> <li>→ form cross-community or cross-border peace committees to facilitate dialogue</li> </ul>
	water stored in dams can easily be stolen by outsiders who did not contribute to establishment	→ agreements must be made covering land use and economic activities in the catchment area, and concerned parties must develop by-laws and moral codes to protect the water resource
	high level of technical knowledge required for the construction of technically advanced structures	→ technical support in the form of training and education; well-functioning advisory service
	as macrocatchment systems often work at a watershed scale, issues such as ownership, local institutions, and land tenure need to be given high priority	→ make sure projects are participatory and collaborative

<sup>a</sup> groundwater dams, <sup>b</sup> surface dams

## Adoption and upscaling

### Adoption rate

Surface dams are widely adopted all over the world. They offer a decentralized alternative to large-scale dams as they can be locally adapted, implemented and managed through smaller scale projects and the communities themselves. The adoption rate for subsurface dams has been low but is gaining ground. The use of natural ponds and pans for water supply (domestic, livestock and wildlife) is widespread throughout the world.

### Enabling environment

**Policy environment:** One complication is that water harvesting and storage often does not have a clear “institutional” home in government administrations. Earth dams used for irrigation evidently form an element of agricultural development, thereby falling under the mandate of Ministries of Agriculture. But as soon as rainfall is stored in a dam or reservoir, it becomes, legally, a water resource, which normally falls under a Water Act, managed by a Ministry of Water Resources (or similar). Thus water and agricultural sectors need to be well coordinated.

**Land and water tenure:** As soon as the demand for runoff water rises, the issue of ownership of runoff water catchments needs to be addressed.

**Access to financial services:** Adoption of MacroWH practices depends primarily on the benefit-cost ratio and the capital needed at the establishment stage. High investment costs may prove to be the most limiting factor for the land and water user. Another limit is that credit systems are not available in all regions; and these are a prerequisite for an investment of this proportion. Credit systems in developing countries demand very high interest rates – often around 15%. However, for excavated ponds the only cost of construction is labour, therefore communities can dig their own ponds with only tools to be purchased.

**Technical support and capacity development:** Optimising catchment areas and designing storage capacities often requires technical advice.

**Suitable approaches for implementation:** Participatory approaches such as the “comprehensive watershed development approach” or “water user groups and associations” as well as “credit or loan schemes” can be used.

### Feasibility and planning

Essential planning steps for implementing MacroWH systems are:

- 1) Assessing the quantity and quality of the water that will be harvested (in rivers, ponds etc.)
- 2) Estimating the water needs in comparison to the capacity of the catchment to supply water
- 3) Making a preliminary site assessment (including soil assessment, estimation of water flows and seasonality, slopes etc.)
- 4) Estimation of construction costs (material, machinery, labour etc)
- 5) An environmental impact assessment
- 6) Accessibility for personnel, equipment and materials
- 7) The planning for MacroWH systems has to be integrated with watershed management planning in order to be sustainable at the watershed scale
- 8) Community involvement and organisation are needed for the planning and maintenance of large-scale, community level, MacroWH systems. In the case of dams, approval for the design and permission for the construction works must be obtained from the authorities
- 9) Traditional water use agreements and water management structures need to be respected and integrated in the planning of MacroWH systems

### Enabling environment: key factors for adoption

Inputs, material	+++
Incentives, credits	+++
Training and education	+++
Land / water use rights	++
Access to markets for inputs and outputs	++
Research	+++
Genuine ownership on the part of communities	+++

Importance: +++ high, ++ medium, + low

### Feasibility and planning: key factors for implementation

Assessing water quantity to be harvested	+++
Assessing water quality	++
Estimating water needs	+++
Site assessment	+++
Financial aspects	+++
Environmental impact assessment	++
Land / water use rights	+++
Neighbourhood relations	+++
Community involvement	+++
Social and gender aspects	+
Official governmental approval	+++

Importance: +++ high, ++ medium, + low



Construction of a rock catchment dam in Kitui, Kenya. (HP. Liniger)

### Example of water tenure from India

In the Naigaon water harvesting project in India, the idea was that, since water is a common property resource, all villagers – irrespective of land ownership – should have equal rights for and access to the utilisation of water. The water rights were therefore detached from land ownership, and when the land was sold, the water rights reverted back to the village group. The new owner did not automatically gain the rights to the water. Mr Salunke – the initiator of the Naigaon project translated this principle into practise by offering membership to the water harvesting based lift-irrigation scheme to landless villagers also. By this arrangement, the landless became share cultivators to farmers having more land than water needed to cultivate that land (Falkenmark et al., 2001).

## References

- African Development Bank. 2009. Rainwater Harvesting Handbook: Assessment of Best Practises and Experience in Water Harvesting. African Development Bank, Tunis. <http://www.rwsn.ch/documentation/skatdocumentation>
- Barron, J. and G. Okwach. 2005. Run-off water harvesting for dry spell mitigation in maize (*Zea mays L.*): results from on-farm research in semi-arid Kenya. *Agricultural Water Management* 74(1):1-21.
- Biazin, B., Sterk, G., Temesgen, M., Abdulkedir, A. and L. Stroosnijder. 2012. Rainwater harvesting and management in rainfed agricultural systems in sub-Saharan Africa: A review. *Physics and Chemistry of the Earth, Parts A/B/C* 47-48 139–151.
- Clements, R., Hagggar, J., Quezada, A. and J.Torres. 2011. Technologies for Climate Change Adaptation: Agriculture Sector. Roskilde: UNEP Risø Centre on Energy, Climate and Sustainable Development.
- Critchley, W. and K. Siegert. 1991. Water Harvesting. A Manual for the Design and Construction of Water Harvesting Schemes for Plant Production. FAO. Rome.
- Falkenmark, M., Fox, P., Persson, G. and J. Rockström. 2001. Water Harvesting for Upgrading of Rainfed Agriculture: Problem Analysis and Research Needs. Stockholm International Water Institute (SIWI) Report 11, Stockholm.
- Foster, S. and A.Tuinhof. 2004. Brazil, Kenya: Subsurface Dams to Augment Groundwater Storage in Basement Terrain for Human Subsistence. Sustainable Groundwater Management Lessons from Practice, Case Profile Collection Number 5. World Bank, Global Water Partnership Associate Program. Washington.
- Fox, P., Rockström, J. and J. Barron. 2005. Risk analysis and economic viability of water harvesting for supplemental irrigation in semi-arid Burkina Faso and Kenya. *Agricultural Systems* 83(3):231-250.
- Jaetzold, R. and Schmidt, H. 1983. Farm Management Handbook of Kenya, Vol. II/C, East Kenya (Eastern and Coast Provinces), Ministry of Agriculture, German Agency for Technical Co-operation (GTZ), Nairobi.
- Knoop, L., Sambalino, F. and F. Van Steenbergen. 2012. Securing Water and Land in the Tana Basin: a Resource Book for Water Managers and Practitioners. 3R Water Secretariat. Wageningen, The Netherlands.
- Liniger, H. and W. Critchley (eds). 2007. Where the land is greener – case studies and analysis of soil and water conservation initiatives worldwide. World Overview of Conservation Approaches and Technologies (WOCAT).
- Liniger, H., Mekdaschi Studer, R., Hauert, C. and M. Gurtner. 2011. Sustainable Land Management in Practice. Guidelines and Best Practices for Sub-Saharan Africa. TerrAfrica, World Overview of Conservation Approaches and Technologies (WOCAT) and Food and Agriculture Organization of the United Nations (FAO).
- Malesu, M.M., Oduor, A.R. and O.J. Odhiambo (eds). 2007. Green Water Management Handbook. Rainwater harvesting for agricultural production and ecological sustainability. Technical Manual No. 8 World Agroforestry Centre (ICRAF), Nairobi, Kenya and Netherlands Ministry of Foreign Affairs.
- Mati, B. M. 2005. Overview of water and soil nutrient management under smallholder rainfed agriculture in East Africa. Working Paper 105. International Water Management Institute (IWMI), Colombo, Sri Lanka.
- Ministries of Water Resources and Irrigation of Sudan and South Sudan. 2009. Technical Guidelines for the Construction and Management of Improved Hafirs: A Manual for Field Staff and Practitioners. MIWR-GONU (Sudan), MWRI-GOSS, UNICEF.
- Motiee, H., McBean, E., Semsar, A., Gharabaghi, B. and V. Ghomashchi. 2006. Assessment of the contributions of traditional qanats in sustainable water resources management. *International Journal of Water Resources Development* 22(4):575-588.
- Mul, M.L., Kemerink, J.S., Vyagusa, N.F., Mshana, M.G., van der Zaag, P. and H. Makurira. 2011. Water allocation practices among smallholder farmers in the South Pare Mountains, Tanzania: the issue of scale. *Agricultural Water Management* 98(11):1752-1760.
- Mutunga, K. and W. Crichley. 2001. Farmers' Initiatives in Land Husbandary: Promising Technologies for the Drier Areas of East Africa. Regional Land Management Unit (RELMA), Swedish International Development Cooperation Agency (Sida). RELMA Technical Report Series 27. Nairobi.
- Nissen-Petersen, E. 2006a. Water from Roads. A handbook for technicians and farmers on harvesting rainwater from roads. ASAL Consultants Ltd., Nairobi, Kenya. [http://www.samsamwater.com/library/Book6\\_Water\\_from\\_roads.pdf](http://www.samsamwater.com/library/Book6_Water_from_roads.pdf)
- Nissen-Petersen, E. 2006b. Water from rock outcrops. A handbook for engineers and technicians on site investigations, designs, construction and maintenance of rock tanks and dams. ASAL Consultants Ltd., Nairobi, Kenya. For the Danish International Development Agency (DANIDA) in Kenya. [http://www.samsamwater.com/library/Book1\\_Water\\_from\\_Rock\\_Outcrops.pdf](http://www.samsamwater.com/library/Book1_Water_from_Rock_Outcrops.pdf)
- Nissen-Petersen E. 2006c. Water from small dams. Handbook for technicians, farmers and others on site investigations, designs, cost estimates, construction and maintenance of small earth dams. ASAL Consultants Ltd., Nairobi, Kenya. For the Danish International Development Agency (DANIDA) in Kenya. [http://www.samsamwater.com/library/Book4\\_Water\\_from\\_Small\\_Dams.pdf](http://www.samsamwater.com/library/Book4_Water_from_Small_Dams.pdf)
- Oweis, T.Y. 2009. Managing water resources under scarcity and climate change. Presentation for IFAD-ICARDA knowledge and technology exchange in NENA region.
- Oweis, T.Y., Prinz, D. and A.Y. Hachum. 2012. Water Harvesting for Agriculture in the Dry Area. ICARDA, CRC Press/ Balkema, Leiden, the Netherlands.
- Oweis, T.Y., Prinz, D. and A.Y. Hachum. 2001. Water Harvesting. Indigenous Knowledge for the Future of the Drier Environments. ICARDA, Aleppo, Syria.
- Prinz, D. 2011. The Concept, Components and Methods of Rainwater Harvesting. In 2nd Arab Water Forum "Living with Water Scarcity".
- Prinz, D. 1996. Water harvesting: Past and Future. In: Pereira L.S., (ed). Sustainability of Irrigated Agriculture. Proceedings, NATO Advanced Research Workshop, Vimeiro, 21 – 26.03.1994. Balkema, Rotterdam.
- RAIN (Rainwater Harvesting Implementation Network). 2009. A practical guide to sand dam implementation: Water supply through local structures as adaptation to climate change. RAIN Foundation / Acacia Water / Ethiopian Rainwater Harvesting Association / Action for Development / Sahelian Solutions Foundation. Wageningen. [http://www.rainfoundation.org/fileadmin/PublicSite/Manuals/Sand\\_dam\\_manual\\_FINAL.pdf](http://www.rainfoundation.org/fileadmin/PublicSite/Manuals/Sand_dam_manual_FINAL.pdf)
- Safriel, U. and Z. Adeel. 2005. Dryland systems. In Hassan, R., Scholes, R. and N. Ash (eds). Ecosystems and Human Wellbeing – Current State and Trends. Vol. 1. Island Press. Washington DC.
- Schwilch, G., Hessel, R. and S. Verzaandvoort (eds). 2012. Desire for Greener Land. Options for Sustainable Land Management in Drylands. Bern, Switzerland, and Wageningen, The Netherlands: University of Bern – CDE, Alterra – Wageningen UR, ISRIC – World Soil Information and CTA – Technical Centre for Agricultural and Rural Cooperation.
- Taamallah, H. (ed). 2010. Gestion durable des terres en Tunisie – Bonnes pratiques agricoles. Land Degradation Assessment in Drylands (FAO-LADA), World Overview of Conservation Approaches and Technologies(WOCAT) and Institut des Régions Arides (IRA, Médenine).
- Tuinhof, A., van Steenbergen, F., Vos, P. and L. Tolck. 2012. Profit from Storage: the Costs and Benefits of Water Buffering. 3R Water Secretariat. Wageningen, The Netherlands.
- Van Dijk, J.A. 1997. Indigenous soil and water conservation by teras in eastern Sudan. *Land Degradation & Development* 8(1):17-26.
- Van Steenbergen, F. and A. Tuinhof. 2009. Managing the Water Buffer for Development and Climate Change Adaptation: Groundwater Recharge, Retention, Reuse and Rainwater Storage. UNESCO International Hydrological Programme. Paris.
- Van Steenbergen, F., Tuinhof, A. and L. Knoop. 2011a. Transforming Lives Transforming Landscapes: the Business of Sustainable Water Buffer Management. 3R Water Secretariat. Wageningen, The Netherlands.

VSF (Vétérinaires sans frontières). 2006. SubSurface Dams: a simple, safe and affordable technology for pastoralists. A manual on SubSurface Dams construction based on an experience of Vétérinaires sans Frontières in Turkana District (Kenya). Vétérinaires sans frontières. Brussels.

Wagner, B. (ed). 2005. Water from ponds, pans and dams. A manual on design, construction and maintenance. Technical Handbook No. 32. Regional Land Management (RELMA) in ICRAF. Nairobi.

WOTR (Watershed Organisation Trust). not dated. Mandwa Village: the Metamorphosis of Life after Water Seeped into its Soil.... Watershed Voices – Experience from the grassroots. WOTR. Maharashtra, India. <http://www.wotr.org/wp-content/uploads/2012/05/Mandwa-village-NEW-WS-voices.pdf>

WOCAT (World Overview of Conservation Approaches and Technologies). 2012. WOCAT Database: Technologies. <http://cdewocat.unibe.ch/wocatQT/index.php>.

Wu, Y., Tang, Y. and C.M. Huang. 2009. Harvesting of rainwater and brooklets water to increase mountain agricultural productivity – a case study from a dry valley of southwestern China. *Natural Resources Forum* 33(1):39-48.

#### Complementary references:

Anderson, I.M. and M. Burton. 2009. Best Practices and Guidelines for Water Harvesting and Community Based (Small Scale) Irrigation in the Nile Basin. Water Harvesting Report. Part I – Best Practices in Water Harvesting. Part II – Guidelines for the implementation of best practices in Water Harvesting. Appendices. Part II – Guidelines for the implementation of best practices in Water Harvesting. Appendix A – List of Reference Material. Kent, Nile Basin Initiative. Efficient Water Use for Agricultural Production Project (EWUAP).

Borst, I. and S.A. de Haas. 2006. Hydrology of Sand Storage Dams: a case study in the Kiindu catchment, Kitui District Kenya, MSc thesis Hydrology, VE University, Amsterdam.

Collins, S. 2000. Hand-dug shallow wells. Series of Manuals on Drinking Water Supply. SKAT. St.Gallen. [http://www.watersanitationhygiene.org/References/EH\\_KEY\\_REFERENCES/WATER/Hand%20Dug%20Wells/Hand%20Dug%20Shallow%20Wells%20\(SKAT\).pdf](http://www.watersanitationhygiene.org/References/EH_KEY_REFERENCES/WATER/Hand%20Dug%20Wells/Hand%20Dug%20Shallow%20Wells%20(SKAT).pdf)

Dest, L., Carucci, V., Wendem-Agenehu, A. and Y. Abebe (eds). 2005. Community Based Participatory Watershed Development, Part 1: A Guideline, Part 2: Annex. Ministry of Agriculture and Rural Development, Addis Ababa, Ethiopia.

Durand, J-M. 2012. Les petits barrages de décru en Mauritanie : Recommandations pour la conception et la construction. Fonds international de développement agricole (FIDA).

Durand, J-M. 2012. Manuel de suivi et d'entretien des petits barrages en Mauritanie. Fonds international de développement agricole (FIDA).

FAO (Food and Agricultural Organisation of the UN). 2001. Small Dams and Weirs in Earth and Gabion Materials. FAO. Rome. <ftp://ftp.fao.org/agl/aglw/docs/misc32.pdf>

FAO (Food and Agricultural Organization of the UN). 2001. Water harvesting in Western and Central Africa. Proceedings of a regional workshop held in Niamey, October, 1999. 117 p. Food and Agriculture Organization, Accra, Ghana. <ftp://ftp.fao.org/agl/aglw/docs/waterharraf.pdf>

FAO (Food and Agricultural Organization of the UN). 2000. Manual de captación y aprovechamiento del agua de lluvia: Experiencias en América Latina. Zonas áridas y semiáridas No. 13. Santiago, Chile, Organización de las Naciones Unidas para la Agricultura y la Alimentación (FAO), Oficina Regional de la FAO para América Latina y el Caribe. <ftp://ftp.fao.org/docrep/fao/010/ai128s/ai128s00.pdf>

Hagos, F., Yohannes, M., Linderhof, V., Kruseman, G., Mulugeta, A., Samuel, G.G. and Z. Abreha. 2006. Micro water harvesting for climate change mitigation: Trade-offs between health and poverty reduction in Northern Ethiopia. Poverty Reduction and Environmental Management. Amsterdam, Netherlands.

Koegel, R.G. 1985. Self-help wells. FAO Irrigation and Drainage Paper. Food and Agricultural Organisation of the UN (FAO). Rome. <http://www.fao.org/docrep/X5567E/X5567E00.htm>

Madrell, S. and I. Neal. 2012. Sand Dams: a Practical Guide. Excellent Development. London.UK

Miller, J.W. 2009. Farm ponds for water, fish and livelihoods. Diversification booklet number 13. FAO. Rom. <ftp://ftp.fao.org/docrep/fao/011/i0528e/i0528e.pdf>

Munyao, J.N., Munywoki, J.M., Kitema, M.I., Kithuku, D.N., Munguti, J.M. and S. Mutiso. 2004. Kitui Sand Dams. Construction and Operation. SASOL Foundation. Kitui, Kenya.

Niemeijer, D. 1998. Soil nutrient harvesting in indigenous teras water harvesting in eastern Sudan. *Land Degradation & Development* 9(4):323-330.

Ngigi, S.N. 2003. What is the limit of up-scaling rainwater harvesting in a river basin? *Physics and Chemistry of the Earth* 28(20-27):943-956.

Nissen-Petersen, E. 2007. Water supply by rural builders. ASAL Consultants Ltd., Nairobi, Kenya. For the Danish International Development Agency (DANIDA) in Kenya.

Nissen-Petersen, E. 2006. Water from Dry Riverbeds – How dry and sandy riverbeds can be turned into water sources by hand-dug wells, subsurface dams, weirs and sand dams. ASAL Consultants Ltd., Nairobi, Kenya. For the Danish International Development Agency (DANIDA) in Kenya. [http://www.samsamwater.com/library/Book3\\_Water\\_from\\_Dry\\_Riverbeds.pdf](http://www.samsamwater.com/library/Book3_Water_from_Dry_Riverbeds.pdf)

Practical Action. 2002. Runoff Rainwater Harvesting: the Path to Enhanced Livelihoods. Technical Brief, the Schumacher Centre. Rugby, UK. <https://practicalaction.org/rainwater-harvesting-answers>

Practical Action. 2002. Sand Dams: Feasible Rainwater Harvesting Technology for Arid and Semi-Arid Land. Technical Brief, the Schumacher Centre. Rugby, UK. <https://practicalaction.org/rainwater-harvesting-answers>

Practical Action. 2002. Water harvesting in Sudan. Technical Brief, the Schumacher Centre. Rugby, UK. <https://practicalaction.org/rainwater-harvesting-answers>

REST (The Relief Society of Tigray). 2011. An overview of REST's implementation of the Productive SafetyNet Programme. *Field Exchange, Emergency Nutrition Network*, Issue 40, pp. 59-66.

Reynoso, D.S.F. and J.L.O. Mota. 2010. Trampa de captación de agua de lluvia para abrevadero. Secretaria de Agricultura, Ganadería, Desarrollo Rural Pesca Y Alimentación (SAGARPA). Mexico. [http://www.sagarpa.gob.mx/desarrolloRural/Documents/fichasCOUSSA/Trampas%20captaci%C3%B3n%20agua%20\(Ollas%20de%20agua\).pdf](http://www.sagarpa.gob.mx/desarrolloRural/Documents/fichasCOUSSA/Trampas%20captaci%C3%B3n%20agua%20(Ollas%20de%20agua).pdf)

Roose, E., Sabir, M. and A. Laouina (eds). 2010. Gestion durable des eaux et des sols au Maroc : valorisation des techniques traditionnelles méditerranéennes. Institut de recherche pour le développement (IRD). Marseille, France. <http://www.documentation.ird.fr/hor/fdi:010054917>.

Sand dam bibliography. <https://sites.google.com/site/sdbibliography/>

Stephens, T. 2010. Manual on small earth dams: a guide to siting, design and construction. FAO Irrigation and Drainage Papers 64. FAO. Rome. <http://www.fao.org/docrep/012/i1531e/i1531e.pdf>

Stern, J.H. and A. Stern. 2011. Water harvesting through sand dams. ECHO Technical Note. ECHO. North Fort Myers, USA.

Tanji, K. and N. Kielen. 2002. Agricultural drainage water management in arid and semi-arid areas. FAO Irrigation and Drainage Papers 61. FAO. Rome. <ftp://ftp.fao.org/agl/aglw/docs/idp61e.pdf>

UNEP-IETC (United Nation Environment Programme – International Environmental Technology Centre). 1998. Sourcebook of Alternative Technologies for Freshwater Augmentation in Some Asian Countries. IETC Technical Publication Series 8b, UNEP-IETC/Danish Hydraulic Institute.

Van Dijk J.A. and M. Ahmed. 1993. Opportunities for Expanding Water Harvesting in Sub-Saharan Africa: a the Case of the Teras of Kassala. International Institute for Environment and Development (IIED). Sustainable Agriculture and Rural Livelihoods Programme.

Zanzibar Water Authority. 2010. Zanzibar Rainwater Harvesting Manual for Training of Trainers for Domestic Supply (draft). Zanzibar Water Authority. <http://www.dlist-asclme.org/sites/default/files/doclib/upload%20December.pdf>

**Audio- visual media:**

BBC – EARTH REPORT. 2003. Tunnel Vision. Film. Produced by: Sapiens Productions. Language: English. <http://www.sapiensproductions.com/qanats.htm>

Centre de Recherche et des Technologies des Eaux (CERTE) Tunisie. 2008. La récupération des eaux pluviales en Tunisie. Video. Produced by: Sapiens Productions. Language: French. Length: 15:43. [http://www.thewaterchannel.tv/index.php?option=com\\_hwdvideoshare&task=viewvideo&Itemid=53&video\\_id=597](http://www.thewaterchannel.tv/index.php?option=com_hwdvideoshare&task=viewvideo&Itemid=53&video_id=597)

Excellent Development. 2009. Sand dams in Kenya. Video. Produced by: Excellent Pioneers of Sand Dams. Language: English. Length: 7.47 min. <http://www.youtube.com/watch?v=YjzcfPax4As&noredirect=1>

IIED (International Institute for Environment and Development) and IFAD (International Fund for Agricultural Development). 2011. Series on Sustainable Land Management Technologies. Videos. Directed by: William Critchley. Produced by: Josephine Rodgers (Country Wise Communication). Language: English. <http://www.thewaterchannel.tv/>

IRHA (International Rainwater Harvesting Alliance). Farm ponds. Water harvesting structures in semi arid areas. Video. Produced by: Vishwanath Srikantaiah. Language: English. Length: 1:47 min. [http://www.irha-h2o.org/?page\\_id=50&vpage=3](http://www.irha-h2o.org/?page_id=50&vpage=3)

IUCN (The International Union for Conservation of Nature). 2011. Of pearls in the sand. Video documentary. Produced by Umbreen Butt and Iskan Khan on behalf of IUCN Pakistan. Language: subtitled English. <http://www.iucn.org/about/union/secretariat/offices/asia/?uNewsID=9050>

RAIN. 2009. Sand dam training in Southern Ethiopia. Video. Produced by: Africa Interactive on behalf of RAIN. Language: English. <http://www.thewaterchannel.tv/>

UNESCO Multimedia Web & Services. Water and systems of irrigation in Central Iran: Qanat, Water, Oasis. Video. Produced by: Abdolhamid Baghaeian. Language: English. Length: 24:56 min. [http://www.unesco.org/archives/multimedia/index.php?s=films\\_details&id\\_page=33&id\\_film=2369](http://www.unesco.org/archives/multimedia/index.php?s=films_details&id_page=33&id_film=2369)

Water for Arid Land. 2010. Sand dams vs Subsurface dams. Video. Produced by: ASAL Consultants, Erik Nissen-Petersen. Language: English. Length: 7.54 min. <http://www.thewaterchannel.tv/en/videos/categories/viewvideo/630/water-harvesting/nissen-petersen-sand-dams-vs-subsurface-dams>

Water for Arid Land. 2010. Water from roads. Video. Produced by: ASAL Consultants, Erik Nissen-Petersen. Language: English. <http://www.thewaterchannel.tv/en/videos/categories/viewvideo/631/water-harvesting/water-from-roads>

Water for Arid Land. 2010. Water from rocks. Video. Produced by: ASAL Consultants, Erik Nissen-Petersen. Language: English. Length: 12.01 min. <http://www.thewaterchannel.tv/en/videos/categories/viewvideo/639/water-harvesting/water-from-rocks>

WOTR (Watershed Organisation Trust). Sattechiwadi – A village Transformed. Video. Produced by: WOTR. Language: English. <http://youtu.be/FKY0Lnsahil>; more WOTR films on <http://youtube.com/user/wotrindia>

**Networks:**

ASAL Consultants Ltd. Water for arid lands. Erik Nissen-Petersen. Nairobi Kenya. <http://waterforaridland.com>

Associação Brasileira de Captação e Manejo de Água de Chuva (ABCMAC). Focus: Brazil. <http://www.abcmac.org.br/index.php?modulo=english>

Centre for Science and Environment (CSE). Focus: India. <http://www.rainwaterharvesting.org>

Excellent. Pioneers of Sand Dams. (NGO). Brentford, UK. Focus: East Africa <http://www.excellentdevelopment.com/index.php>

Greater Horn of Africa Rainwater Partnership (GHARP). Focus: Horn of Africa. <http://www.gharainwater.org>

Practical Action. (NGO). Focus: Global. <https://practicalaction.org/rainwater-harvesting-answers>

Rainwater Harvesting Implementation Network (RAIN). Focus: Global. <http://www.rainfoundation.org>

Sand Dam Organisation. Focus: ??? [www.sanddam.org](http://www.sanddam.org)

World Overview of Conservation Approaches and Technologies (WOCAT) Focus: Global. <https://www.wocat.net/>

Watershed Organisation Trust (WOTR): NGO /implementing agency for Watersheds & Ecosystems Management; Focus: India. <http://www.wotr.org/wotr-projects/watershed-development/>

**Recurrent events:**

10th International Water Association (IWA) Specialist Group Conference on Ponds Technology: Advances and Innovations in Pond Treatment Technology on 19-22 August 2013; Cartagena, Colombia. Organised by: International Water Association (IWA) Specialist Group Conference on Ponds Technology. <http://www.source.irc.nl/page/73308>

**Selected WOCAT Case Studies:**

India: Sunken streambed structure (doh). QTIND03. [http://cdewocat.unibe.ch/wocatQT/qt\\_summary.php?qt\\_id=449](http://cdewocat.unibe.ch/wocatQT/qt_summary.php?qt_id=449)

Zambia: Small earth dams. QTZAM001. [http://cdewocat.unibe.ch/wocatQT/qt\\_summary.php?qt\\_id=28](http://cdewocat.unibe.ch/wocatQT/qt_summary.php?qt_id=28)

Kenya: Sand dams. QTKEN653. [http://cdewocat.unibe.ch/wocatQT/qt\\_summary.php?qt\\_id=653](http://cdewocat.unibe.ch/wocatQT/qt_summary.php?qt_id=653)

Tunisia: Recharge well. QTTUN14. [http://cdewocat.unibe.ch/wocatQT/qt\\_summary.php?qt\\_id=234](http://cdewocat.unibe.ch/wocatQT/qt_summary.php?qt_id=234)





## Sunken streambed structure

India – *Doh* (Hindi)

**Excavations in streambeds to provide temporary storage of runoff, increasing water yields from shallow wells for supplementary irrigation.**

*Dohs* are rectangular excavations in seasonal streambeds, which are intended to capture and hold runoff to enhance groundwater recharge, thus increasing water for irrigation from nearby shallow wells. They also collect and impound subsurface flow. *Dohs* are built in semi-arid areas where rainfall is low and seasonal. The dimension of a typical *doh* is 1.0–1.5 m deep with variable length (up to 40 m) and width (up to 10 m) depending on streambed section, with an average capacity of 400 m<sup>3</sup>.

The excavated material is deposited along the stream banks as a barrier against siltation from surrounding areas. The slopes of the excavation are gentle (an upstream slope of 1:6 or 17% and a downstream slope of 1:8 or 12%) so that water flows into it, and excess water out again, carrying silt rather than depositing it. The sides however are steep, to increase capacity – and would benefit from stone pitching to stabilise them. A silt trap comprising a line of loose boulders is constructed upstream across the streambed. *Dohs* are generally built in sequence. They may be as close as a few metres apart. Bends in the stream are avoided as these are susceptible to bank erosion.

The technology is used in conjunction with shallow wells (odees), which enable farmers to harvest the increased groundwater for supplementary irrigation of annual crops – including vegetables such as chilli peppers. Water is pumped out of the wells. In the case study village, Mohanpada, each *doh* basically supplies an underground source of extra water to one well. Communities together with project staff carry out site selection, and then detailed design/estimates/layout is done with project technical assistance. As a supportive measure the catchment area is treated with gully plugs (small stone checks in gullies). A water harvesting tank (small reservoir or dam) may be excavated above the series of *dohs* where this is justified by a sufficiently large catchment area/suitable site. The capacity of the tank at Mohanpada is around 600 m<sup>3</sup> and thus also has a positive impact on groundwater recharge.

Maintenance is agreed through meetings of user groups: manual desilting is planned and repairs of gully plugs also. In summary, *dohs* are low cost water recharge alternatives for poorer communities, and in this case study, the extra area brought under production has meant that all families that require it, now have access to some water for irrigation.

**Above left:** A series of *dohs* temporarily filled with runoff water before infiltration. (Photo: David Gandhi)

**Above right:** Harvesting chilli peppers from land brought under irrigation through the effect of *dohs*. (Photo: William Critchley)

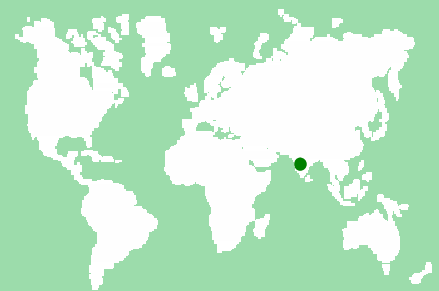

**Location:** Mohanpada, Ratlam

**Region:** Madhya Pradesh, India

**Technology area:** 0.1 km<sup>2</sup>

**Conservation measure:** structural

**Stage of intervention:** mitigation / reduction of land degradation

**Origin:** developed externally / introduced through project, traditional, >50 years ago

**Land use:** cropland and grazing land

**Climate:** semi-arid, tropics

**WOCAT database reference:** QT IND003en on cdewocat.unibe.ch/wocatQT

**Related approach:** Comprehensive watershed development, QA IND01

**Compiled by:** VK Agrawal and David Gandhi, Ratlam, Madhya Pradesh, India

**Date:** October 2002, updated June 2004



## Classification

**Land use problems:** There are regular poor yields of agricultural crops on the degraded, rainfed fields. A further constraint is the limited amount of water in wells, restricting both the extent of irrigation, and the number of people with access to irrigation. There is an underlying problem of poverty, which in turn leads to seasonal out-migration to find work.

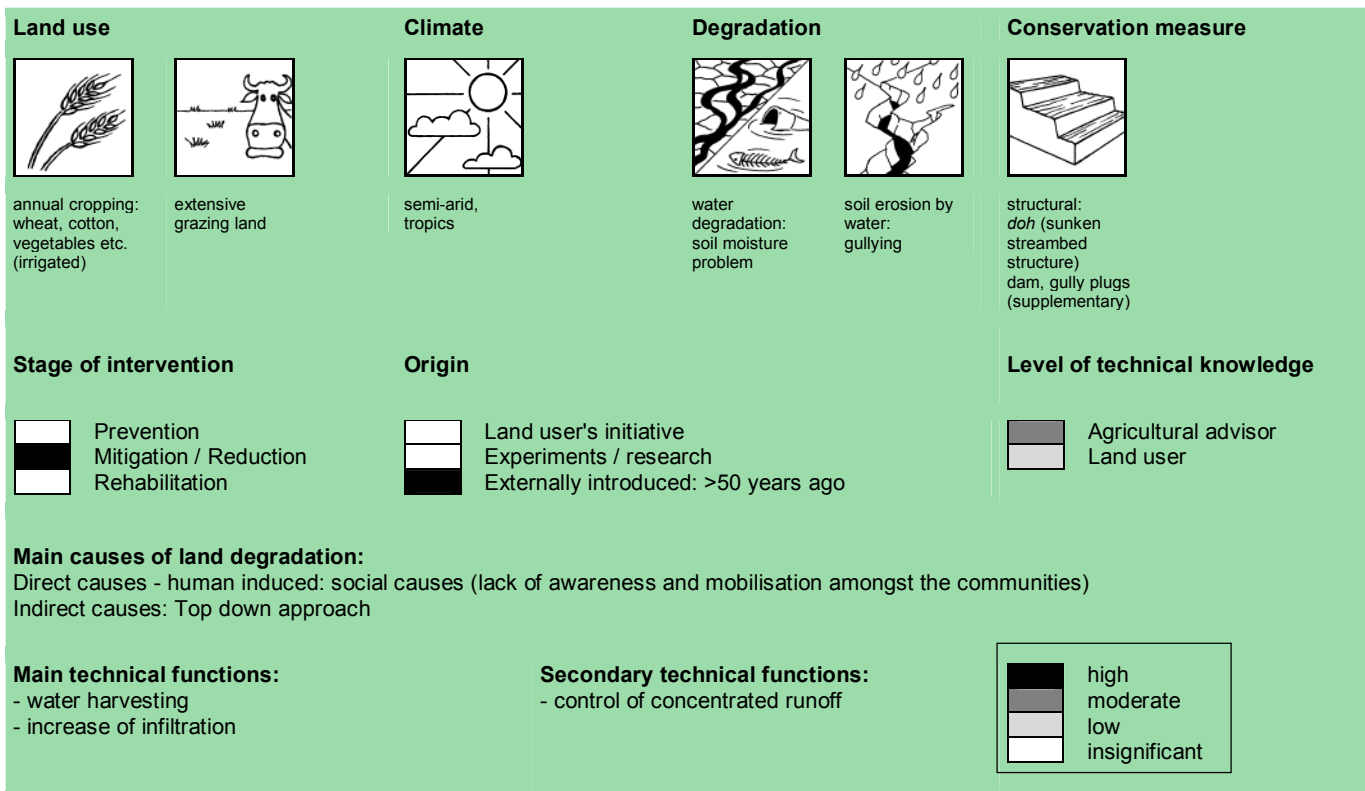

## Environment

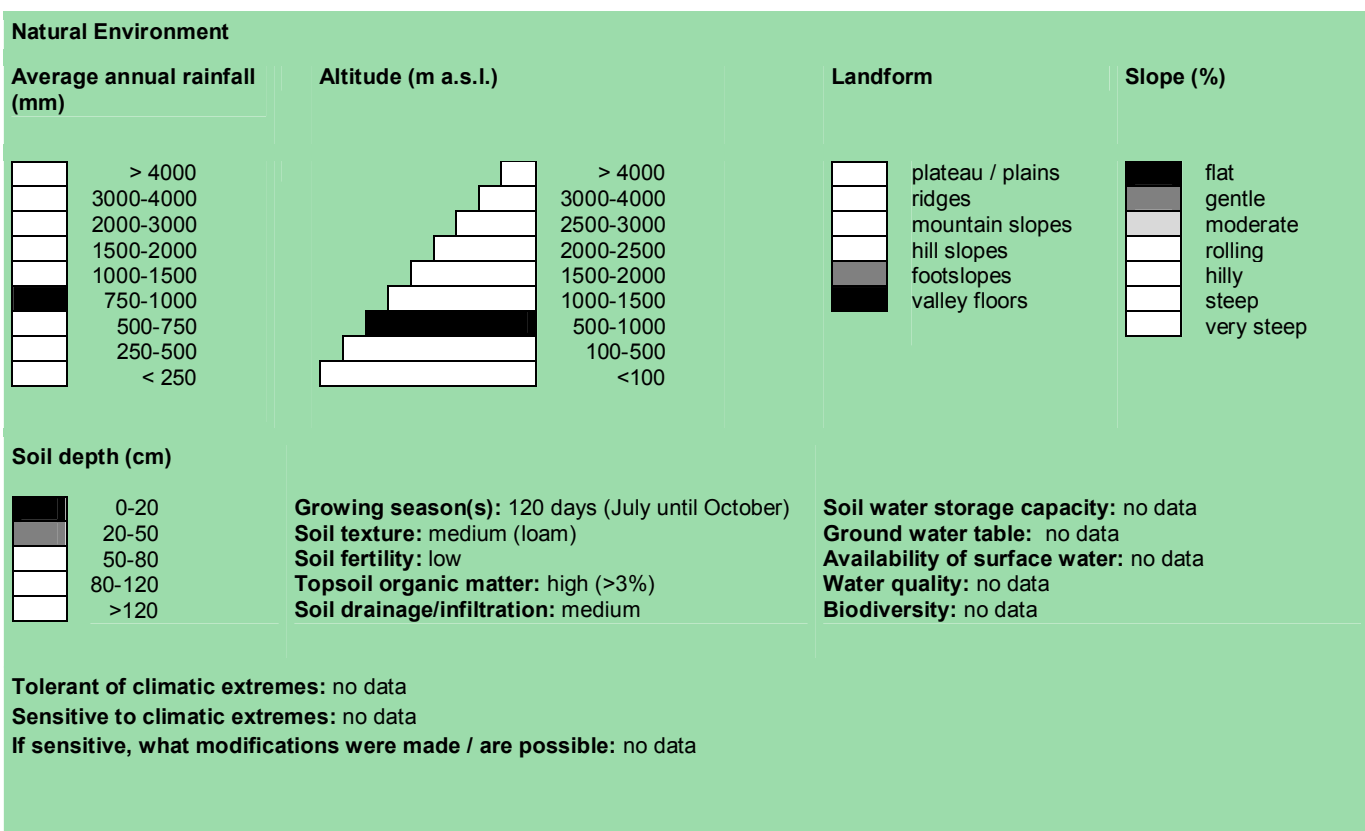

## Human Environment

### Cropland per household (ha)

█	<0.5
█	0.5-1
█	1-2
█	2-5
█	5-15
█	15-50
█	50-100
█	100-500
█	500-1,000
█	1,000-10,000
█	>10,000

**Land user:** no data  
**Population density:** > 500 persons/km<sup>2</sup>  
**Annual population growth:** > 4 %  
**Land ownership:** individual, titled  
**Land use rights:** individual  
**Water use rights:** no data  
**Relative level of wealth** very poor, which represents 80% of land users.

**Importance of off-farm income:** 10–50% of all income: some migratory work in nearby towns and in large scale mechanised farms during peak periods (note: now there is less migration as a result of increased irrigation)  
**Access to service and infrastructure:** moderate: employment, energy; high: health, education, technical assistance, market, roads & transport, drinking water and sanitation, financial services  
**Market orientation:** mixed (subsistence and commercial)  
**Mechanization:** no data  
**Livestock grazing on cropland:** no data

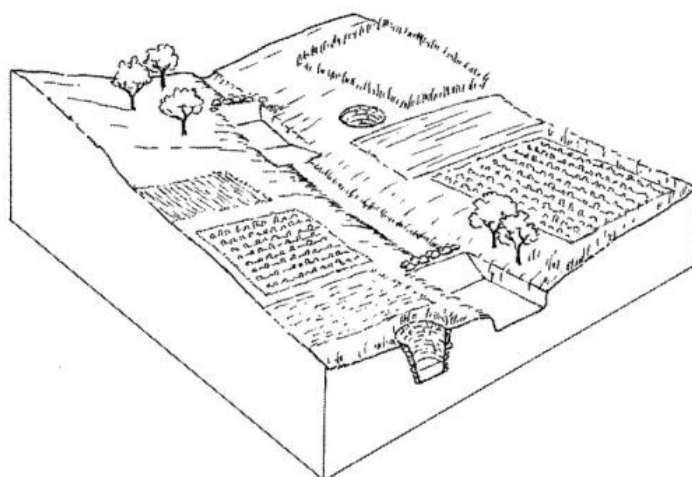

### Technical drawing

Overview of sunken streambed structures (*doh*) with associated wells and irrigated plots. Note that several *dohs* are applied in series along the waterway. (Mats Gurtner)

## Implementation activities, inputs and costs

### Establishment activities

1. Site selection with the community by eye.
2. Identification of the beneficiaries and user groups.
3. Design and estimations by project staff using surveying instruments ('dumpy levels') and measuring tapes.
4. Agreement of village committee.
5. Catchment treatment begins – using hand tools: including water harvesting tank (capacity in this case about 600 m<sup>3</sup>) and small gully plugs from earth or loose stone, as required.
6. Excavation of *dohs* (200–400 m<sup>3</sup>) as last action with silt traps upstream of each made from loose stone.
7. Wells (*odees*) may be deepened and pumps bought – though those costs are not included here.

Duration of establishment: 1 year

### Establishment inputs and costs per ha

Inputs	Costs (US\$)	% met by land user
Labour (225 person days)	225	25
Equipment - tools	15	100
Construction material - stone (2 m <sup>3</sup> )	0	
<b>TOTAL</b>	<b>240</b>	<b>30</b>

### Maintenance/recurrent activities

1. Desilting of *dohs* in dry periods by hand.
2. Maintenance of catchment treatments (desilting of gully plugs etc) if required.

### Maintenance/recurrent inputs and costs per ha per year

Inputs	Costs (US\$)	% met by land user
Labour (5 person days)	5	100
<b>TOTAL</b>	<b>5</b>	<b>100</b>

**Remarks:** The construction of one *doh* costs between US\$ 200–400, depending on the size of the *doh* (approximately one cubic metre can be excavated per person day at a cost of one US dollar). On a per hectare basis the costs are very variable, since they are related to the extra area brought under irrigation. In this case study there are four *dohs* within a total village area of 50 ha. Ten of the 50 ha have been brought into irrigated production (extra to the 5 ha already irrigated) due to the four *dohs* and the 'tank' and the costs outlined above are spread over those 10 ha. In this case half of the costs are directly attributable to *dohs* (average capacity 400 m<sup>3</sup> each), and half to catchment treatment where the water-harvesting tank (a reservoir of approximately 600 m<sup>3</sup>) is the main cost. Where there is underlying rock, mechanical drills and blasting by dynamite may be required, which increases the costs. That was not the case in this village. The cost of deepening/widening the five wells (*odees*) has not been included here: that is carried out by the villagers themselves. While the project normally pays around 85% of labour costs, here at Mohanpada village the project only needs to pay 75%, due to a high level of commitment by the villagers.

## Assessment

Impacts of the Technology	
<b>Production and socio-economic benefits</b> +++ increased crop yield + increased farm income	<b>Production and socio-economic disadvantages</b> + increased economic inequity in some villages
<b>Socio-cultural benefits</b> +++ improved conservation / erosion ++ knowledge community institution strengthening	<b>Socio-cultural disadvantages</b> + socio cultural conflicts + reduced amount of water to downstream users
<b>Ecological benefits</b> +++ increased soil moisture +++ groundwater increase ++ improved soil cover ++ reduced soil loss	<b>Ecological disadvantages</b> None
<b>Off-site benefits</b> +++ reduced downstream flooding ++ reduced downstream siltation + increased stream flow in dry season + reduced river pollution	<b>Off-site disadvantages</b> + reduced peak flows
<b>Contribution to human well-being/livelihoods</b> no data	

+++ : high, ++ : medium, + : low

Benefits/costs according to land user	Benefits compared with costs	
	short-term:	long-term:
Establishment	positive	very positive
Maintenance/recurrent	positive	very positive

**Acceptance/adoption:** 100% of land user families (1600 families; 70% of area) have implemented the technology with external material support. There is little trend towards (growing) spontaneous adoption of the technology. Farmers in Mohanpada have constructed one *doh* with only 10 % subsidy on the total cost. Spontaneous adoption is growing in neighbouring villages.

## Concluding statements

Strengths and → how to sustain/improve	Weaknesses and → how to overcome
<p><i>Dohs</i> are a low cost alternative method of increasing groundwater in a semi-arid area where production of high value legumes depends on irrigation – and <i>dohs</i> represent the best way in this situation of expanding the extent of irrigated land, and bringing irrigation to more families.</p> <hr/> <p>Small, multiple recharge points for replenishing groundwater for irrigation from wells → breaking hard pan in stream bed mechanically by drills or blasting to deepen <i>dohs</i> and thereby make them more effective.</p> <hr/> <p>No risk of breaches of bunds as the structures are sunken below ground.</p>	<p>Group maintenance is required → form user groups.</p> <hr/> <p>Villagers are more used to (and may prefer) larger and deeper 'tanks' → establish more <i>dohs</i> to create more impact.</p> <hr/> <p><i>Dohs</i> are limited in capacity and thus dry up quickly, as do the wells → establish more <i>dohs</i> to create more impact.</p>

**Contact person(s):** Agrawal VK and Nayak T: danidain@mantrafreenet.com or pmdanida@sancharnet.in; Comprehensive Watershed Development Project, 22 Pratap Nagar, RATLAM – 457 001, MP, India David Gandhi: david\_gandhi@yahoo.com



## Small Earth Dams

Zambia

**Water harvesting and storage structures to impound runoff generated from upstream catchment areas.**

Small earth dams are water harvesting storage structures, constructed across narrow sections of valleys, to impound runoff generated from upstream catchment areas. Construction of the dam wall begins with excavation of a core trench along the length of the dam wall which is filled with clay and compacted to form a 'central core' that anchors the wall and prevents or minimizes seepage. The upstream and downstream embankments are also built using soil with 20-30% clay content. During construction – either by human labour, animal draught or machine (bulldozer, compacter, grader etc.) – it is critical to ensure good compaction for stability of the wall. It is common to plant Kikuyu grass (*Pennisetum clandestinum*) to prevent erosion of the embankment. The dam is fenced with barbed wire to prevent livestock from eroding the wall. Typical length of the embankment is 50-100 m with water depth ranging 4-8 m. An emergency spillway (vegetated or a concrete chute) is provided on either, or both sides, of the wall for safe disposal of excess water above the full supply level. The dam water has a maximum throwback of 500 m, with a capacity ranging from 50,000 – 100,000 m<sup>3</sup>.

The dams are mainly used for domestic consumption, irrigation or for watering livestock. If the dams are located on communal lands, their establishment requires full consultation and involvement of the local community. The government provides technical and financial assistance for design, construction and management of these infrastructures. Community contribution includes land, labour and local resources. The community carries out periodic maintenance of the infrastructure – including vegetation management on embankment, desilting etc. – and of the catchment areas (through soil and water conservation practices).

**Above left:** Manual construction of a small dam requires community action: soil is transported in bags, piled up and compacted layer by layer. (Photo: Maimbo Malesu)

**Above right:** Fetching water for domestic use at a small dam. (Photo: Maimbo Malesu)

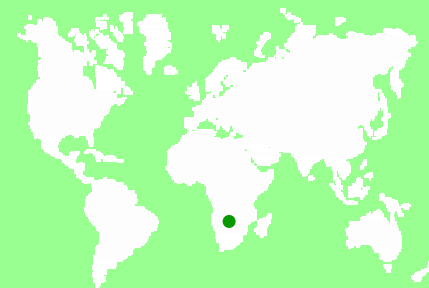

**Region:** Southern Province

**Technology area:** In the study area there are over 293 dams serving a cattle population of 1.1 million and human population of nearly 1 million people

**Conservation measure:** structural

**Stage of intervention:** prevention of land degradation, mitigation / reduction of land degradation

**Origin:** developed externally / introduced through project, 10-50 years ago

**Land use:** cropland and grazing land

**Climate:** semi-arid, subtropics

**WOCAT database reference:** QT ZAM001en on [cdewocat.unibe.ch/wocatQT](http://cdewocat.unibe.ch/wocatQT)

**Related approach:** not documented



**Compiled by:** Maimbo Malesu, ICRAF-CGIAR; World Agroforestry Centre, Nairobi, Kenya

**Date:** 01st Jan 1970, updated 2011

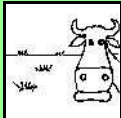
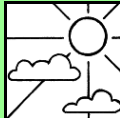

## Classification

**Land use problems:** water degradation, soil erosion, low surface water availability

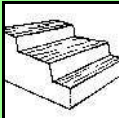
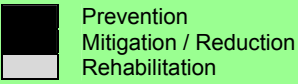
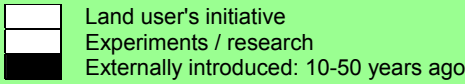
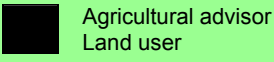
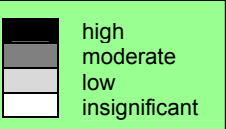
Land use		Climate		Degradation	Conservation measure
					
annual cropping (rainfed)	extensive grazing land	semi-arid	sub-humid, subtropics	water degradation: reduced surface water availability	structural: dams / pans (to store excessive water)
Stage of intervention		Origin		Level of technical knowledge	
					
<b>Main causes of land degradation:</b> Direct causes - natural: heavy / extreme rainfall (intensity/amounts), floods					
<b>Main technical functions:</b> - water harvesting / increase water supply - control of concentrated runoff: retain / trap		<b>Secondary technical functions:</b> none			

## Environment

### Natural Environment

#### Average annual rainfall (mm)

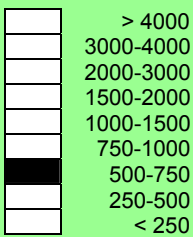

#### Altitude (m a.s.l.)

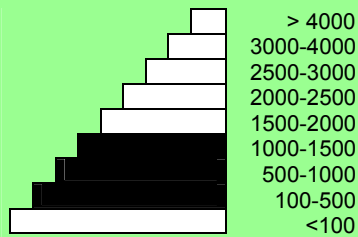

#### Landform

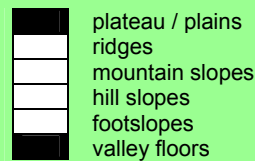

#### Slope (%)

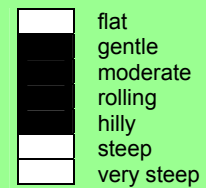

#### Soil depth (cm)

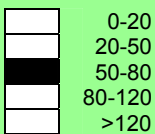

**Growing season(s):** 120 days (November until April)  
**Soil texture:** coarse / light (sandy), medium (loam)  
**Soil fertility:** medium  
**Topsoil organic matter:** medium (1-3%)  
**Soil drainage/infiltration:** no data

**Soil water storage capacity:** no data  
**Ground water table:** no data  
**Availability of surface water:** poor / none  
**Water quality:** no data  
**Biodiversity:** no data











**Tolerant of climatic extremes:** temperature increase, seasonal rainfall increase, seasonal rainfall decrease, wind storms / dust storms, droughts / dry spells, decreasing length of growing period

**Sensitive to climatic extremes:** heavy rainfall events (intensities and amount), floods

**If sensitive, what modifications were made / are possible:** no data

## Human Environment

### Cropland per household (ha)

	<0.5
	0.5-1
	1-2
	2-5
	5-15
	15-50
	50-100
	100-500
	500-1,000
	1,000-10,000
	>10,000

**Land user:** groups / community, small scale land users, disadvantaged land users  
**Population density:** <10 persons/km<sup>2</sup>  
**Annual population growth:** 3-4%  
**Land ownership:** communal / village, not titled  
**Land use rights:** communal (organised)  
**Water use rights:** no data  
**Relative level of wealth:** poor

**Importance of off-farm income:** no data  
**Access to service and infrastructure:** no data  
**Market orientation:** mixed (subsistence and commercial)  
**Mechanization:** animal traction  
**Livestock grazing on crop residues:** no

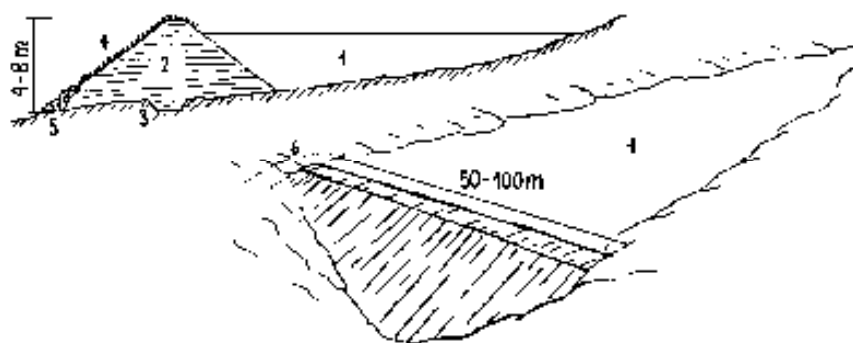

### Technical drawing

Dimensions and main components of a small dam: (1) water body; (2) dam wall (with layers of compacted soil; side slopes 3:1); (3) central core ('key'); (4) grass cover; (5) stone apron; (6) spillway (Mats Gurtner)

## Implementation activities, inputs and costs

### Establishment activities

1. Site selection in consultation with community.
2. Dam survey and design: Topographical survey of dam area; using levelling equipment (dumpy level or theodolite); Determination of dam wall dimensions.
3. Dam wall construction: Excavate core trench (usually 4 m wide; 2 m deep). Excavate and transport clay-rich soil to the dam site. Construct core and embankments (slope angles 3:1). Continuously compact placed soil.
4. Construct lateral spillway(s), 5-30 m wide (depending on the flood flow and the return slope).
5. Design and installation of irrigation and drainage infrastructure (in case of crop production).
6. Completion: plant Kikuyu grass on dam embankment, spillway and irrigation canals and fence of; alternatively line with cement.

### Establishment inputs and costs per ha

Inputs	Costs (US\$)	% met by land user
Labour (633 person-days)	2'000	
Equipment - tools	30'000	
Construction material - stone	15'000	
Agricultural - seeds	1'000	
- fertilizer	1'000	
- biocides	1'000	
<b>TOTAL</b>	<b>50'000</b>	<b>20</b>

### Maintenance/recurrent activities

1. Catchment conservation to minimise siltation of dam and irrigation infrastructure (continuous).
2. (Re-)planting grass on dam and irrigation infrastructure (annually, using hand hoes).
3. Desilting of the dam (every 5-10 years): excavate and remove the silt deposited in the dam.
4. Cleaning of dam and irrigation infrastructure: remove trees / shrubs from dam / canals. If concrete lined: repair of any damages.

### Maintenance/recurrent inputs and costs per ha per year

Inputs	Costs (US\$)	% met by land user
Labour (63 person-days)	200	
Equipment - machine use	2'000	
Construction material - stone	1'500	
Agricultural - grass, seed, fertilizer	300	
<b>TOTAL</b>	<b>4'000</b>	<b>80</b>

**Remarks:** Establishment costs are calculated for a dam with an earthwork volume of 10,000 m<sup>3</sup> (44 m long; 8 m deep; side slopes 3:1). 20% of costs are borne by the community (in-kind contribution: labour and local materials such as sand, stones). Construction machinery can include: tipper truck, bulldozer, motor scraper, compactor, tractor, grader.

## Assessment

Impacts of the Technology	
<b>Production and socio-economic benefits</b> +++ increased crop yield +++ increased irrigation water availability ++ increased animal production ++ increased farm income	<b>Production and socio-economic disadvantages</b> none
<b>Socio-cultural benefits</b> +++ improved food security ++ community institution strengthening + increased recreational opportunities	<b>Socio-cultural disadvantages</b> none
<b>Ecological benefits</b> +++ increased water quantity +++ improved harvesting / collection of water ++ recharge of groundwater table / aquifer + reduced hazard towards adverse events	<b>Ecological disadvantages</b> none
<b>Off-site benefits</b> +++ increased water availability +++ reduced downstream flooding	<b>Off-site disadvantages</b> none
<b>Contribution to human well-being/livelihoods</b> no data	

+++ : high, ++ : medium, + : low

Benefits/costs according to land user	Benefits compared with costs	
	short-term:	long-term:
Establishment	negative	very positive
Maintenance/recurrent	neutral	very positive

**Acceptance/adoption:** Records of 1991 indicate at least 537 such dams exist in Zambia. In the study area there are over 293 dams serving a cattle population of 1.1 million and human population of nearly 1 million people.

## Concluding statements

Strengths and → how to sustain/improve	Weaknesses and → how to overcome
Small earth dams allow for the diversification of income activities including tree nurseries, brick making, fish farming, raising ducks and geese and thus alleviate poverty → improvement of access to markets will be crucial to support such income generating activities.	Dams are communally owned → requires strong organisation and commitment by community.
Saves people's time by reducing the distance to fetch water for domestic use → clear and equitable water use rights and agreements.	Risk of siltation → de-silting and catchment conservation is essential.
Reduced risk of crop failure by bridging prolonged dry periods and as such contribute to food security and climate change adaptation → combine with water saving cultivation practices such as mulching, pitting etc.	Vulnerability to climate change → increase depth and design storage to last at least for two rainy seasons.
Reduced damages from soil erosion and flooding by storing excessive runoff → water use an integrated watershed management approach to reduce flood and erosion risk.	Evaporation and seepage losses → maintain minimum design depth of 4 meters; if seepage is high: provide impervious material on the upstream embankment, i.e. clay or plastic lining if necessary.
Possibility for watering cattle near the village reduced soil compaction and erosion → regulate access of cattle to avoid degradation around the water source and protect water source from pollution.	

**Key reference(s):** Frot, E., van Wesemael, B., Benet, A.S. and House, M.A., 2008. Water harvesting potential in function of hillslope characteristics: A case study from the Sierra de Gador (Almeria province, south-east Spain). *Journal of Arid Environments*, 72(7): 1213-1231

**Contact person(s):** Maimbo Malesu, ICRAF-CGIAR; Nairobi, Kenya; m.malesu@cgiar.org



## Sand dams

Kenya - Sand storage dams, groundwater dams

**A sand dam is a stone masonry barrier across a seasonal sandy riverbed that traps rainwater and sand flowing down the catchment.**

A sand dam is typically 1 - 5 metres high and 10-50 metres across. When it rains the dam captures soil laden water behind it – the sand in the water sinks to the bottom, whilst the silt remains suspended in the water. Eventually the dams fill with sand - sometimes after only one rainfall or over 1 – 3 seasons. 25 to 40% of the volume of the sand held is actually water. A mature sand dam can store millions of litres of water – refilling after each rainfall providing a year round supply to over 1,000 people.

Sand dams are a simple, low cost and low maintenance, replicable rainwater harvesting technology. They provide a clean, local water supply for domestic and farming use and are suited to arid and semi-arid areas of the world. It is a solution that is scalable and has a broader application for use as a rural and game park road crossing to replace less effective culvert bridges.

Sand dams are the lowest cost form of rainwater harvesting and its robust nature and very low operational and maintenance costs make it particularly suited to remote and poorly served regions. A typical dam using 500 bags of cement would approx. be 40 metres in length with a spillway 2 metres above the bedrock. The dam is constructed using stone masonry placed in timber formwork. Such a dam costs approx.. USD 11,800 (in 2012 prices). This consists of materials (cement, steel reinforcement, timber, transport) and dam permit USD 8,800 (75%), project management including technical support from skilled local artisans and dam designers USD 2150 (18%) and finance and administration costs of implementing organisation USD 850 (7%). Local people freely contribute their labour to collect rock, sand and water, terrace and protect the immediate catchment and construct the dam. If this contribution was costed and included the cost of the dam would almost double. The maintenance and repair costs of the dam provided it has been well designed and constructed is negligible. Local users are responsible for the management and repair of the dam and its abstraction system. Where a hand pump is fitted, local users fund the repair and replacement of the pump as required. The purchase and repair of petrol powered water pumps which some groups use to irrigate adjacent land is the responsibility of the members of the local group.

Because the water is stored within the sand, evaporation losses are very low, the sand filters the water and water-vector diseases such as malaria are controlled. Sand dams provide significant environmental benefits such as aquifer recharge, increased downstream flows in the dry-season, rejuvenation of river ecologies and moderation of floods. As such, it contributes to ecosystem services and climate change adaption.

**Above left:** An example of a mature sand dam in the Nzyaa Muysio valley. (Photo: Simon Maddrell)

**Above right:** An example of a second mature sand dam in the same valley. (Photo: Polly Braden)

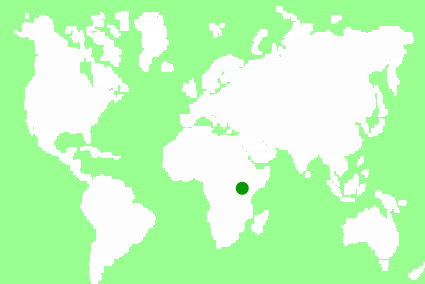

**Location:** Machakos, Kitui and Makueni Counties

**Region:** Eastern Province, Kenya

**Technology area:** 1,000 - 10,000 km<sup>2</sup>

**Conservation measure:** structural

**Stage of intervention:** prevention / mitigation

**Origin:** developed externally / introduced through project, 10-50 years ago

**Land use:** other land (waterways, drainage lines, ponds, dams)

**Climate:** semi-arid, subtropics

**WOCAT database reference:** QT KEN653en on [cdewocat.unibe.ch/wocatQT](http://cdewocat.unibe.ch/wocatQT)

**Related approach:** not documented

**Compiled by:** Ian Neal, Excellent Development Ltd.











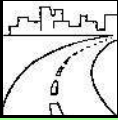
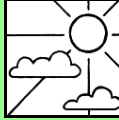

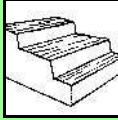

**Date:** 27th Mar 2012









































## Classification

**Land use problems:** "We used to fetch water from Londokwe; we could spend a night to collect water. One way was 3 to 10 km and up to 12 hours or more to go and come back [because of the time taken to queue]. If we could not make it to the river, we would send our children to fetch water. When they went fetching water that would mean they did not go to school. At times people would fight over fetching water from other people's scoop holes. Scoop holes would be guarded in turns. The gourds [water containers] would be damaged and the water poured down. Children would not go to school [as they needed to] take care of the young ones as the parents went to fetch water. Children would fail to go to school because they were hungry – just because there was no water to cook." Yikiuuku SHG Drylands are characterised by intense and variable rainfall and a lack of vegetative cover. As a result, drylands are prone to droughts, flooding and soil erosion which result in endemic water and food scarcity

<p><b>Land use</b></p>  <p>waterways, drainage lines, ponds, dams</p>	<p><b>Climate</b></p>  <p>semi-arid, subtropics</p>	<p><b>Degradation</b></p>  <p>water degradation: change in quantity of surface water</p>	<p><b>Conservation measure</b></p>  <p>structural: graded ditches / waterways, dams / pans</p>
<p><b>Stage of intervention</b></p> <ul style="list-style-type: none"> <li> Prevention</li> <li> Mitigation / Reduction</li> <li> Rehabilitation</li> </ul>	<p><b>Origin</b></p> <ul style="list-style-type: none"> <li> Land user's initiative: 10-50 years ago</li> <li> Experiments / research: &lt; 10 years ago</li> <li> Externally introduced: 10-50 years ago</li> </ul>	<p><b>Level of technical knowledge</b></p> <ul style="list-style-type: none"> <li> Agricultural advisor</li> <li> Land user</li> </ul>	
<p><b>Main causes of land degradation:</b> Direct causes - natural: heavy / extreme rainfall (intensity/amounts), droughts</p>		<p><b>Main technical functions:</b></p> <ul style="list-style-type: none"> <li>- control of concentrated runoff: retain / trap</li> <li>- water harvesting / increase water supply</li> <li>- improvement of water quality, buffering / filtering water</li> </ul>	<p><b>Secondary technical functions:</b></p> <ul style="list-style-type: none"> <li>- increase of groundwater level / recharge of groundwater</li> <li>- sediment retention / trapping, sediment harvesting</li> <li>- promotion of vegetation species and varieties (quality, e.g. palatable fodder)</li> </ul>
<p><b>Level of technical knowledge</b></p> <ul style="list-style-type: none"> <li> high</li> <li> moderate</li> <li> low</li> <li> insignificant</li> </ul>			

## Environment

<p><b>Natural Environment</b></p>			
<p><b>Average annual rainfall (mm)</b></p> <ul style="list-style-type: none"> <li> &gt; 4000</li> <li> 3000-4000</li> <li> 2000-3000</li> <li> 1500-2000</li> <li> 1000-1500</li> <li> 750-1000</li> <li> 500-750</li> <li> 250-500</li> <li> &lt; 250</li> </ul>	<p><b>Altitude (m a.s.l.)</b></p> <ul style="list-style-type: none"> <li> &gt; 4000</li> <li> 3000-4000</li> <li> 2500-3000</li> <li> 2000-2500</li> <li> 1500-2000</li> <li> 1000-1500</li> <li> 500-1000</li> <li> 100-500</li> <li> &lt;100</li> </ul>	<p><b>Landform</b></p> <ul style="list-style-type: none"> <li> plateau / plains</li> <li> ridges</li> <li> mountain slopes</li> <li> hill slopes</li> <li> footslopes</li> <li> valley floors</li> </ul>	<p><b>Slope (%)</b></p> <ul style="list-style-type: none"> <li> flat</li> <li> gentle</li> <li> moderate</li> <li> rolling</li> <li> hilly</li> <li> steep</li> <li> very steep</li> </ul>
<p><b>Soil depth (cm)</b></p> <ul style="list-style-type: none"> <li> no data</li> <li> 0-20</li> <li> 20-50</li> <li> 50-80</li> <li> 80-120</li> <li> &gt;120</li> </ul>	<p><b>Growing season(s):</b> no data  <b>Soil texture:</b> no data  <b>Soil fertility:</b> no data  <b>Topsoil organic matter:</b> no data  <b>Soil drainage/infiltration:</b> no data</p>		<p><b>Soil water storage capacity:</b> very high  <b>Ground water table:</b> 5 - 50 m  <b>Availability of surface water:</b> excess (e.g. flood)  <b>Water quality:</b> good drinking water  <b>Biodiversity:</b> high</p>
<p><b>Tolerant of climatic extremes:</b> temperature increase, seasonal rainfall increase, seasonal rainfall decrease, heavy rainfall events (intensities and amount), wind storms / dust storms, floods, droughts / dry spells, decreasing length of growing period  <b>If sensitive, what modifications were made / are possible:</b> The capacity of the spillway would be increased to control peak flood events</p>			

## Human Environment

### Cropland per household (ha)

no data
<0.5
0.5-1
1-2
2-5
5-15
15-50
50-100
100-500
500-1,000
1,000-10,000
>10,000

**Land user:** groups / community, small scale land users, common / average land users, mainly women  
**Population density:** 50-100 persons /km<sup>2</sup>  
**Annual population growth:** 2-3%  
**Land ownership:** state  
**Land use rights:** communal (organised) (Legal agreements for construction and access between the self-help group and the owners of land adjacent to the dam and registering the dam and its associated water rights by the self-help group with the Kenyan Water Resources management Authority (WRMA) is vital to safeguarding water rights, controlling water and sand abstraction, formalising the authority of the self-help group to levy water tariffs if appropriate and ensuring there is open access to all to water from scoop holes)

**Water use rights:** same as for land use rights  
**Relative level of wealth:** poor  
**Importance of off-farm income:** less than 10% of all income: This varies considerably, but most self-help group members are subsistence farmers  
**Access to service and infrastructure:** low: technical assistance, employment (e.g. off-farm), market, energy, drinking water and sanitation, financial services; moderate: health, education, roads & transport  
**Market orientation:** no data  
**Mechanization:** no data  
**Livestock grazing on crop residues:** no data

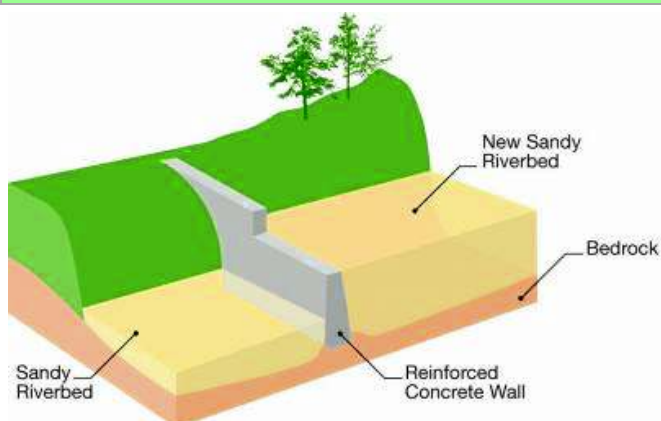

### Technical drawing

Cross-section of sand dam  
(Excellent Development)

## Implementation activities, inputs and costs

### Establishment activities

1. Collection of rock, sand and water
2. Construct dam
3. Cure dam
4. Terracing and protection of immediate catchment)

### Establishment inputs and costs per ha

Inputs	Costs (US\$)	% met by land user
Labour	2'500	100
Equipment - tools	300	0
Construction material		
- stone	0	0
- sand	0	0
- cement	5'000	0
- steel	0	0
Other		
- skilled labour	3'000	0
Equipment - tools	11'800	21

### Maintenance/recurrent activities

1. Inspect and if necessary extend spillway or repair erosion around dam
2. Maintain hand pump if fitted

### Maintenance/recurrent inputs and costs per ha per year

no data

**Remarks:** Each dam is individually designed. The size, design and cost of a dam varies considerably with the size of the river and to a lesser extent, location and transport costs. Sand dams are the world's lowest cost method of capturing rainwater in dry rural areas by a factor of 3 to 30 times compared to rain water harvesting tanks, earth dams, hafirs and rock catchments. In 2012, in Machakos County, Kenya, the cost of materials and technical support for a dam using 250 bags of cement is US\$ 7,000 and US\$ 11,700 for a 500 bag dam. The costs in 2.6.1 are based on a 500 bag dam. The volume of a 500 bag dam is approx.. 140 m<sup>3</sup> of stone masonry of which 40% is mortar (sand and cement) and 60% is rock. Such a dam will typically be appropriate on rivers 30 m wide and with a spillway 3 metres above the bedrock in the river bed level. Costs rise by up to 50% in more remote regions or countries. Sand dams require a lot of hard work. Community members collect the required stones, sand and water, support construction and terrace the land around the dam. If this in-kind contribution is included the costs would rise by 100%. In Kenya, with a long tradition of building sand dams, it takes from 6 to 12 weeks to plan and prepare for construction and 2 days to 2 weeks to build the dam. In other areas, with less experience and/or less community commitment, building a dam may take 6 months or more.

## Assessment

### Impacts of the Technology

#### Production and socio-economic benefits

- +++ decreased labour constraints
- ++ increased fodder production
- ++ increased wood production
- ++ reduced risk of production failure
- ++ increased drinking water availability
- ++ increased water availability / quality
- ++ increased irrigation water availability quality
- ++ increased farm income
- ++ diversification of income sources
- ++ decreased workload
- ++ reduced water borne disease
- + increased crop yield
- + increased fodder quality
- + increased animal production
- + increased product diversification
- + Increased school attendance

#### Production and socio-economic disadvantages

none

#### Socio-cultural benefits

- +++ improved food security / self-sufficiency
- ++ improved cultural opportunities
- ++ improved conservation / erosion knowledge
- ++ improved health
- ++ improved incomes
- ++ improved fuel security
- ++ improved livestock health
- ++ reduced conflict
- + community institution strengthening

#### Socio-cultural disadvantages

none

#### Ecological benefits

- +++ increased water quantity
- +++ increased water quality
- +++ improved harvesting / collection of water
- +++ increased soil moisture
- +++ reduced evaporation
- ++ recharge of groundwater table / aquifer
- ++ reduced hazard towards adverse events
- + reduced surface runoff
- + reduced emission of carbon and greenhouse gases
- + reduced salinity
- + increased plant diversity
- + increased / maintained habitat diversity

#### Ecological disadvantages

none

#### Off-site benefits

- ++ reduced downstream flooding
- ++ increased stream flow in dry season
- ++ improved buffering / filtering capacity
- ++ reduced damage on public / private infrastructure
- + increased water availability
- + reduced downstream siltation

#### Off-site disadvantages

none

#### Contribution to human well-being/livelihoods

++ Sand dams save farmers hours every day that they can invest in improving their farms to grow more food and create the potential for farmers to irrigate trees and crops, water livestock and generate an income. It is strongly advised that sand dams are integrated within a wider land management and livelihoods program in order to realise these opportunities to the maximum. Community ownership and management is critical to achieving this.

+++ : high, ++ : medium, + : low

Benefits/costs according to land user	Benefits compared with costs	short-term:	long-term:
	Establishment	positive	very positive
	Maintenance/recurrent	very positive	very positive

The very low cost of operating and maintaining sand dams means they are well suited to remote, poorly served regions. Because it is a low cost technology that requires a major community contribution and the knowledge and skills of locally trained artisans, it's a solution particularly suited to community ownership and self-supply. This contributes to effective implementation.

**Acceptance/adoption:** 100% of land user families have implemented the technology with external material support. Sand dams require external material support including technical advice to correctly site, design and construct. 0% of land user families have implemented the technology voluntary. There is some evidence of spontaneous adoption amongst development agencies working in regions suited to sand dams.

## Concluding statements

Strengths and → how to sustain/improve	Weaknesses and → how to overcome
<p>Sand dams provide a safe, reliable, year round, local supply of water for people, crops and livestock in water scarce environments. → the very low cost of operating and maintaining sand dams means they are well suited to remote, poorly served regions. Community ownership is critical to their effective management.</p>	<p>Although sand dams are technically replicable, their application in new contexts requires careful understanding and consideration → Excellent Development has developed a framework tool to help agencies identify the political, economic, social, technical, legal and environmental factors that should be taken account of when introducing sand dams to a new context.</p>
<p>Sand dams save farmers hours every day that they can invest in improving their farms to grow more food and create the potential for farmers to irrigate trees and crops, water livestock and generate an income → don't build a sand dam in isolation.</p>	<p>Sand dams require the technical knowledge and skills of local artisans in order to correctly site, design and construct them → the technical barriers to adoption are low: The technical skills required have and can be developed locally. Learning exchanges between implementing organisations and developing technical manuals and resources aids this learning.</p>
<p>Because it is a low cost technology that requires a major community contribution and the knowledge and skills of locally trained artisans, it's a solution particularly suited to community ownership and self-supply. This contributes to effective implementation → don't short cut community ownership. Genuine community commitment and ownership from initial planning to on-going management is vital to realise the intended benefits and full potential created by a dam. Legal registration and agreements to safeguard community access and water rights help this.</p>	<p>This is a drylands solution. Sand dams can only be built on seasonal rivers with sufficient sandy sediment and where the bedrock or impermeable layer is accessible in the river bed → increase awareness of the criteria that determine the technical suitability of a site. Use simple field tests, such as sediment seiving and probing, to assess potential sites and to map the potential application of sand dams.</p>
<p>Sand dams provide significant environmental benefits such as aquifer recharge, increased downstream flows in the dry-season, rejuvenation of river ecologies and moderation of floods. As such, it contributes to eco-system services and climate change adaption → support terracing, tree planting and conservation farming in the wider catchment. This conserves soil and water on farms, increases aquifer recharge and base flows into the dam and reduces the amount of silt in the sand dam aquiver. Research and disseminate evidence of these benefits and the value of these eco-system services.</p>	
<p>The technology is scalable and has a broader application for use as a rural and game park road crossing to replace less effective culvert bridges → in order to upscale this solution, there is a need for greater awareness and advocacy of the technology and its benefits amongst these groups.</p>	

**Key reference(s):** Practical guide to sand dam implementation: Water supply through local structures as adaptation to climate change, the RAIN Foundation, 2008 [www.sanddam.org/](http://www.sanddam.org/)Films on sand dams and related conservation technologies and approaches, Excellent Development [www.excellentdevelopment.com/](http://www.excellentdevelopment.com/) Website with selected bibliography and resources on sand dams and related water technologies [www.samsamwater.com/Library/Sand Dam Advocacy Brochure](http://www.samsamwater.com/Library/Sand%20Dam%20Advocacy%20Brochure), Excellent development, 2011 / Be buffered website including Managing the Water Buffer for Development and Climate Change Adaptation. Groundwater recharge, retention, reuse and rainwater storage. Steenbergen F. van and A. Tuinhof. (2009) which includes sand dams, [www.bebuffered.com/3rbook](http://www.bebuffered.com/3rbook)  
**Contact person(s):** Ian Neal, Excellent Development Ltd. [ian@excellent.org.uk](mailto:ian@excellent.org.uk) / Silu Andrew Musila ,Africa Sand Dam Foundation, P.O Box 125 - 90128, Mtito Andei, Kenya, [musila.asdf@gmail.com](mailto:musila.asdf@gmail.com) /Maddrell Simon Excellent development, 59, The Market building, 195 The high Stree, Brentford, TW8 8LB, UK. [simon@excellent.org.uk](mailto:simon@excellent.org.uk)





## Recharge well

Tunisia - *Puits filtrant (French)*

**A recharge well comprises a drilled hole, up to 30-40 m deep that reaches the water table, and a surrounding filter used to allow the direct injection of floodwater into the aquifer.**

The main worldwide used methods to enhance groundwater replenishment are through recharge basins or recharge wells. Though groundwater recharge aiming at storage of water in the periods of abundance for recovery in times of drought has a long history dating back millennia, the recharge wells began to be used only in the twentieth century, especially during the Second World War following concerns on attacks of the water supply facilities. Its use was extended later to sea intrusion control, treated waste water, water harvesting in the dry areas, and strategic water storage.

Recharge wells are used in combination with gabion check dams to enhance the infiltration of floodwater into the aquifer. In areas where the permeability of the underlying bedrock in front of a gabion is judged too low, recharge wells could be installed in wadi (ephemeral river) beds. Water is retained by the gabion check dam and it flows through the recharge well allowing accelerated percolation into the aquifer.

A recharge well consists of a long inner tube surrounded by an outer tube, the circumference of which ranges between 1 and 2 m. The area between the tubes is filled with river bed gravel which acts as a sediment filter. Water enters the well through rectangular-shaped openings (almost 20 cm long and a few mm in width) located in the outer tube, and it flows in the inner hole having passed through the gravel and the rectangular shaped openings of the drill hole. The above-ground height is around 2 to 3 m whereas the depth is linked to the depth of the water table (normally up to 40 m). The drill hole connects directly with the aquifer, where it is connected either directly with the water table or indirectly via cracks. Pond volume is dependent on the size of the gabion check dam but generally ranges between 500 and 3000 m<sup>3</sup>. The filtered water can directly flow into the aquifer at a rate exceeding what would occur naturally through the soil and the underlying strata.

The design should be conducted primarily by a hydrogeologist and a soil and water conservation specialist in order to determine the potential sites and the required drilling equipment. Drilling needs to be carried out by a specialized company.

Depending on the geological setting, the overall cost is around 5000 to 10000 US\$. The recharge wells are used to recharge the deep groundwater aquifers, which are mainly exploited by government agencies. However, private irrigated farms are benefiting indirectly by increased groundwater availability.

**Above left:** A recharge well reduces the length of time of standing water, and thus evaporation, by injecting flood water rapidly into the aquifer, where it is stored and recovered later to be used for different purposes. This is an example of a recharge well behind a gabion check dam after rain. (Photo: M. Ouessar)

**Above right:** A recharge well needs to be always combined with a gabion check dam which prevents floodwater movement downstream and creates a temporary pond. (Photo: S. Temmerman)

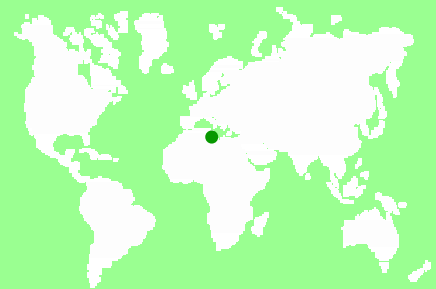

**Location:** Medenine

**Region:** Medenine nord

**Technology area:** 10 - 100 km<sup>2</sup>

**Conservation measure:** structural

**Stage of intervention:** prevention of land degradation

**Origin:** developed externally / introduced through project, 10-50 years ago

**Land use:** cropland, grazing land

**Climate:** arid, subtropics

**WOCAT database reference:** QT TUN014en on [cdewocat.unibe.ch/wocatQT](http://cdewocat.unibe.ch/wocatQT)

**Related approach:** Dryland watershed management approach (QA TUN09)

**Compiled by:** Mohamed Ouessar, Houcine Yahyaoui, Institut des Régions Arides (IRA), Tunisia

**Date:** 31st Jan 2009, updated 10th Jun 2011



## Classification

Land use problems: Runoff water loss, riverbank erosion, flooding risk, aridity

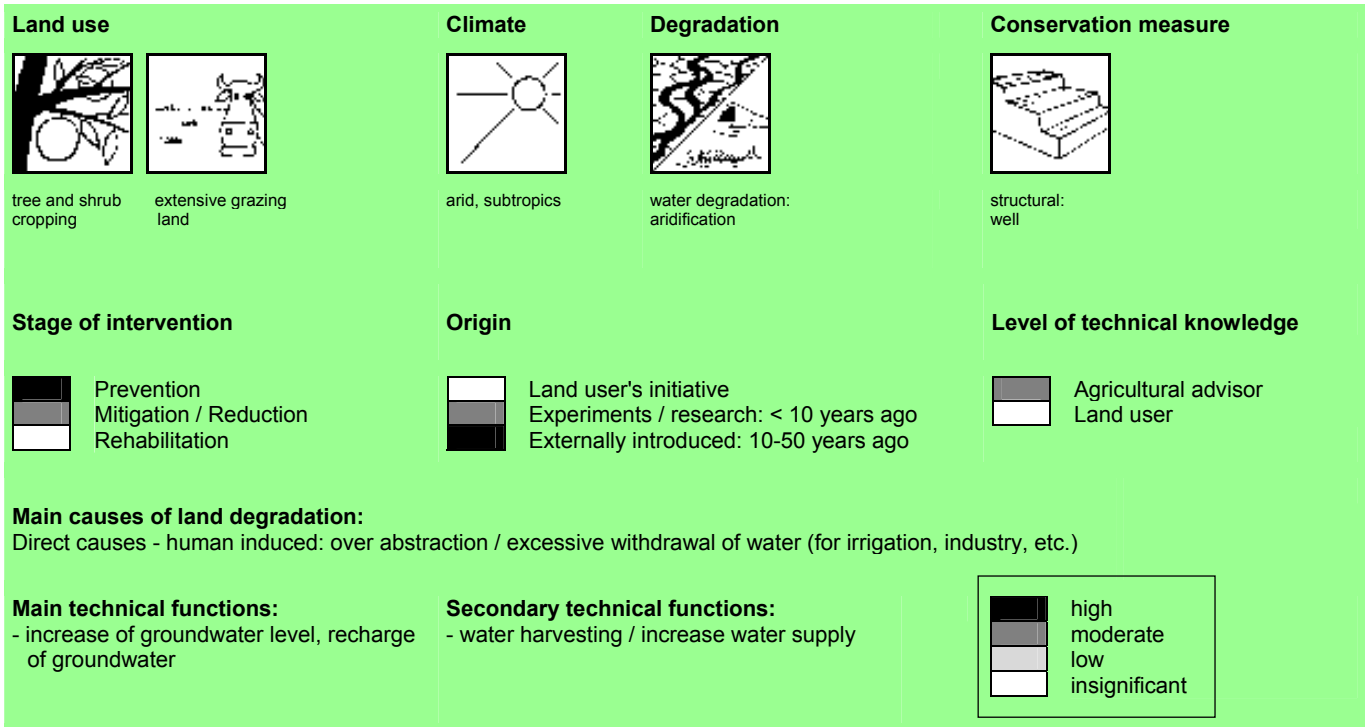

## Environment

### Natural Environment

#### Average annual rainfall (mm)

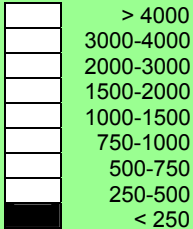

#### Altitude (m a.s.l.)

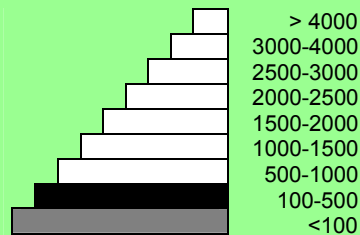

#### Landform

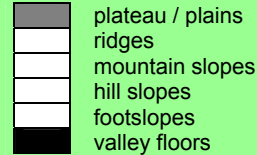

#### Slope (%)

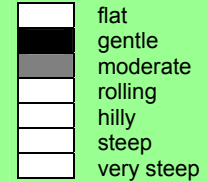

#### Soil depth (cm)

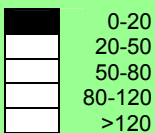

**Growing season(s):** 180 days (October until April)

**Soil texture:** medium (loam)

**Soil fertility:** very low

**Topsoil organic matter:** low (<1%)

**Soil drainage/infiltration:** medium

**Soil water storage capacity:** medium

**Ground water table:** 5 - 50 m

**Availability of surface water:** poor, but with periods of excess (e.g. flood)

**Water quality:** medium

**Biodiversity:** medium

**Tolerant of climatic extremes:** all except extreme floods

**Sensitive to climatic extremes:** extreme floods

## Human Environment

### Mixed land per household (ha)

	<0.5
	0.5-1
	1-2
	2-5
	5-15
	15-50
	50-100
	100-500
	500-1,000
	1,000-10,000
	>10,000

**Land user:** employee (company, government)  
**Population density:** 10-50 persons/km<sup>2</sup>  
**Annual population growth:** 0.5-1%  
**Land ownership:** state  
**Land use rights:** communal (organised)  
**Water use rights:** communal (organised)  
**Relative level of wealth:** average, which represents 70% of land users; 75% of the total land area is owned by average land users

**Importance of off-farm income:** > 50% of all income

**Access to service and infrastructure:** low: financial services; moderate: health, technical assistance, employment, market, energy, roads and transport, drinking water and sanitation; high: education

**Market orientation:** mixed (subsistence and commercial)

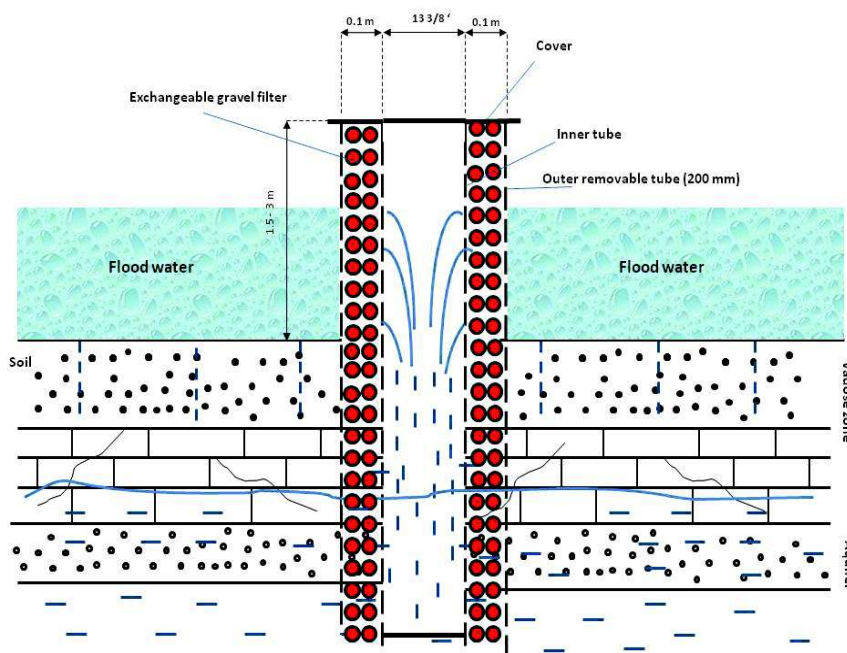

### Technical drawing

Schematic representation of the main components of a recharge well. The flood water retained behind the gabion check dam flows through the outer tube and the gravel filter into the water table. Clogging of the filter is one of the major problems to be considered and solved. (Mohamed Ouessar)

## Implementation activities, inputs and costs

### Establishment activities

1. Drilling
2. Installation

### Establishment inputs and costs per unit

Inputs	Costs (US\$)	% met by land user
Labour	7'000	0
Construction material	1'000	0
<b>TOTAL</b>	<b>8'000</b>	<b>0</b>

### Maintenance/recurrent activities

1. Desilting of the filter
2. Repairs

### Maintenance/recurrent inputs and costs per unit per year

Inputs	Costs (US\$)	% met by land user
Labour	500	0
Construction material	100	0
<b>TOTAL</b>	<b>600</b>	<b>0</b>

**Remarks:** The costs per unit can be taken as per one hectare of land benefiting from the recharge well. Labour is the most determining factor affecting the costs. The local wage rate is 10 US\$/day.



## Assessment

Impacts of the Technology	
<b>Production and socio-economic benefits</b> +++ increased drinking water availability ++ increased water availability / quality for livestock ++ increased irrigation water availability / quality	<b>Production and socio-economic disadvantages</b> None
<b>Socio-cultural benefits</b> + conflict mitigation + improved conservation / erosion knowledge	<b>Socio-cultural disadvantages</b> None
<b>Ecological benefits</b> +++ recharge of groundwater table / aquifer ++ improved harvesting / collection of water ++ reduced hazard towards adverse events (flooding, drought) ++ reduced salinity	<b>Ecological disadvantages</b> ++ risks of contamination of aquifers
<b>Off-site benefits</b> ++ increased water availability ++ reduced downstream flooding + reduced damage on public / private infrastructure	<b>Off-site disadvantages</b> ++ reduction of surface water to reach downstream areas
<b>Contribution to human well-being/livelihoods</b> ++ increased availability of water for drinking, agriculture and livestock	

+++: high, ++: medium, +: low

Benefits/costs according to land user	Benefits compared with costs	
	short-term:	long-term:
	<b>Establishment</b>	very positive / positive
	<b>Maintenance/recurrent</b>	very positive / positive

Long-term benefits are slightly reduced due to silting problems.

**Acceptance/adoption:** No land-user families have implemented the technology with external material support. It is solely constructed by the government agencies.

## Concluding statements

Strengths and → how to sustain/improve	Weaknesses and → how to overcome
Replenishment of the aquifer → good selection of the site and drilling methods.	Silting up of the filter → maintenance of the filters.
	Malfunition due to aquifer geometry and characteristics → good selection of the sites.
	Retain water for downstream users → proper watershed management plan.

**Key reference(s):** Yahyaoui, H., Ouessar, M. 2000. Abstraction and recharge impacts on the ground water in the arid regions of Tunisia: Case of Zeuss-Koutine water table. UNU Desertification Series, 2: 72-78 / Temmerman, S. 2004. Evaluation of the efficiency of recharge wells on the water supply to the water table in South Tunisia. Graduation dissertation, Ghent University, Belgium.

**Contact person(s):** Ouessar Mohamed, Institut des Régions Arides, 4119 Medenine, Tunisia, Yahyaoui Houcine, CRDA, 4100 Medenine, Tunisia, Ouessar.Mohamed@ira.mrt.tn

# MICROCATCHMENT WATER HARVESTING



*Demi-lunes with mulching, Niger. (HP. Liniger)*

## In a nutshell

### Short description

Microcatchment water harvesting systems (MicroWH) are designed to trap and collect runoff from a relatively small catchment area, usually (10–500 m<sup>2</sup>) within the farm boundary. The runoff water is guided into an application area where it accumulates in holes, pits, basins and bunds. It infiltrates into the soil, and is used to grow plants. The collected water is stored in the root zone and supplies crops such as sorghum, millet, maize, shrubs, trees or fodder crops. The ratio between the catchment (collection) area to the cultivated (application) area can vary between 2:1 and 10:1. The size of the catchment can be easily controlled by the farmer, which makes the system easy to adapt and replicate. MicroWH are small systems replicated many times with identical designs. Catchment and application areas are alternating within the same field, thus rainwater is concentrated on a confined surface where plants are grown. In comparison, MacroWH are much larger systems with one catchment outside the cultivated area.

### Water storage and purpose

The collected water is stored within the soil profile – in the root zone – and used for plant growth. When such systems are applied over a wide area, then there may be significant groundwater recharge.

### Most common technologies

Planting pits (e.g. *zai*, *tassa*, *chololo*), microbasins (e.g. *negarim*, *meskat*), triangular / V-shaped bunds, semi-circular bunds, eyebrow terraces, Vallerani WH basins, cross-slope barriers (e.g. vegetative barriers / strips, tied ridges, contour bunds / ridges, stone bunds, contour bench terraces).

### Applicability

MicroWH is suitable for semi-arid to arid areas with high rainfall variability within seasons. They can be constructed on almost any slope, including nearly level plains – wherever there is overland flow to capture. Soils need to be deep enough to construct holes, pits and to store the collected water. Soils with an inclination to sealing and crusting are particularly suitable for inducing runoff in the catchment area. Furthermore, MicroWH can be applied on highly degraded soils where it can be used in the productive rehabilitation process, reducing erosion and flooding.

Improved water availability	
Drinking water (high quality)	n/ap
Domestic use (household)	n/ap
Livestock sedentary	n/ap
Livestock pastoral	+
Rainfed agriculture	+++
Opportunistic irrigation	n/ap
Supplementary irrigation	n/ap
Irrigation of backyard crops / kitchen gardens	+
Aquifer recharge	+
Development issues addressed	
Preventing / reversing land degradation	+++
Maintaining and improving food security	+++
Reducing rural poverty	++
Creating rural employment	+
Supporting gender equity / marginalised groups	+
Reduced risk of production failure	+++
Improving crop production (including fruit trees)	+++
Improving fodder production	++
Improving wood / fibre production	++
Improving water productivity	+
Trapping sediments and nutrients	++
Enhancing biodiversity	++
Natural disaster prevention / mitigation	+
Climate change mitigation	+++
Climate change adaptation	
Resilience to extreme dry conditions	+
Resilience to variable rainfall	++
Resilience to extreme rain and wind storms	+
Resilience to rising temperatures and evaporation rates	++

Importance: +++ high, ++ medium, + low, +/- neutral, n/ap: not applicable

## Resilience to climate variability

Water harvesting in microcatchments reduces risks of production failure due to water shortage associated with rainfall variability and dry spells. It accumulates and concentrates water and enables crop growth (including establishment of trees) in areas where rainfall is normally not sufficient, or unreliable. Although runoff farming methods can increase the water availability, climatic risks still exist and in years with extremely low rainfall, it cannot compensate for overall water shortages.

### Main benefits

- Increased water availability, reduced risk of production failure, enhanced crop, fodder and tree production and improved water use efficiency.
- Simple to design and control, and cheap to install (and to adapt) by individual farmers, therefore easily replicable.
- Higher runoff collection efficiency than medium or large-scale water harvesting systems; negligible conveyance losses.
- Erosion control and trapping of nutrient-rich sediments in runoff.
- The area to be prepared for planting as well as fertilizer inputs are reduced compared to conventional preparation of the entire field, while overall production is improved and the risk of failure reduced.

### Main disadvantages

- Catchment uses potentially arable land (with the exception of steep slopes).
- Catchment area has to be maintained, i.e. kept free of vegetation. However, crusts often develop on bare surfaces of the catchment and therefore naturally reduce weed growth.
- As in all water harvesting systems, systems can be damaged during exceptionally heavy rainstorms.
- If maintenance is inadequate, soil erosion can occur and initial investment will be lost.

### Benefit-cost ratio

Technology	short term	long term
Planting pits	+ / ++	+++
Microbasins and trenches	- / +	+++
Vegetative strips	+	++
<i>Fanya juu</i> terraces	-	++
Stone lines and bunds	- / +	++
Overall	+	++

--- very negative; -- negative; - slightly negative; - / + neutral; + slightly positive; ++ positive; +++ very positive; (WOCAT, 2012).

Costs for the establishment of MicroWH systems are principally labour, which compared to MacroWH is less demanding. For non-permanent structures and annual crops, these costs re-occur every planting season. In this case, the long-term benefit-cost ratio is lower than that of permanent structures required in MacroWH. In addition, regular inputs are mainly agricultural – such as seeds, compost, fertilizer, etc.

### Adoption and upscaling

Overall, adoption rates for MicroWH practices remain relatively low – with some notable exceptions such as on the Central Plateau of Burkina Faso where *zaï* planting pits can be seen everywhere. Land users hesitate to invest where there is inadequate land tenure security or limited market access to sell surplus. Pitting systems require little finance – but high labour input; on the other hand permanent structures such as stone bunds incur high establishment costs. The less costly practices are therefore more easily adopted and more widespread than the latter.



Large-scale application of microcatchments in China. (HP. Liniger)



Microcatchments with eyebrow terraces for tree planting, Orissa, India. (HP. Liniger)

### Example: Furrow enhanced WH for olives in Syria

Runoff collection has been used to plant olive orchards in north-west Syria in areas which are considered too dry for olives. In one trial, trees were planted 8 m apart, within and between rows. Around individual trees 'fish-bone' shaped furrows were dug to harvest runoff water. The furrows were constructed manually with a hoe and reinforced with stones. They divert rainwater runoff to the microcatchments, where it concentrates in basins around the trees. Each tree is served by a catchment area of 60 m<sup>2</sup>. The furrows are re-made every year (F. Turkelboom et al. in Liniger and Critchley, 2007; WOCAT, 2012).



Runoff collection furrows in Syrian olive orchards. (F. Turkelboom)

## Technology

### Planting pits

Planting pits are mini-basins planted with a few seeds of annual or perennial crops. They come in different sizes, shapes and densities (pits/ha). Pits are usually 20–30 cm wide and 20–30 cm deep and spaced 60 cm–1 m apart. The C:A ratio 3:1. They are dug by hand. The excavated earth is placed downslope of the pit and sometimes formed into a small ridge to best capture rainfall and runoff. Manure and/or fertilizer are added to each pit if available. Pits are often found in combination with stone lines to rehabilitate degraded and crusted lands, and to bring them back into cultivation. Grass growing between the stones helps increase infiltration further and accelerates the accumulation of fertile sediment. Planting pits are applied on flat to gently sloping land (0–5%) that receives rainfall of 350–600 mm/y. Common examples are: *tassa* in Niger, *zai* pits in Burkina Faso, *chololo* pits in Tanzania, *agun* pits in Sudan, *kofyar* pits in Nigeria, *katumani* pits as well as *tubukiza* pits for fodder production in Kenya, *yamka* in Kyrgyzstan: *yamkas* are used to plant trees in pits on school yards, squares and other flat ground where irrigation is impossible or impractical. These pits can also be used for annual crops.

*Ngoro (matengo)* pits in Tanzania have a slightly different design: they are square-shaped, wider and deeper, and each pit is surrounded by four bunds of soil which are built on a layer of grass. Crops (often maize) are planted on those bunds in order to profit from nutrients provided by the decomposing grass.

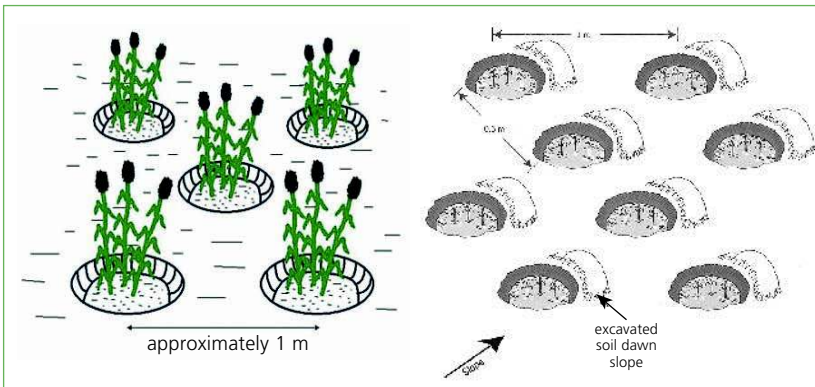

Left: *Zai* pits from Burkina Faso (Mati, 2005).

Right: Technical drawing of *chololo* pits from Tanzania (Mutunga and Critchley, 2001).

### Characteristics of selected planting pits

Name	Country	Crop	Shape	Depth (cm)	Width (cm)	Inter-row distance (cm)	In-row distance (cm)
<i>Zai</i>	Burkina Faso	sorghum	circular	15–50	30–50	60–75	30–50
<i>Katumani</i>	Kenya	fodder	crescent	15–20	n/a	n/a	continuous
<i>Chololo</i> pits	Tanzania	millet	circular	20–25	20–25	100	0.5
Banana pits	Kenya, Tana	banana	square	60	60	300	300
Sugar cane pits	Kenya, Mwingi	sugar cane	square	60–75	100	60	60
Five by nine pits	Kenya	maize	square	60	60	n/a	n/a
<i>Tumukiza</i>	Western Kenya	napier	various	various	various	various	various

n/a: not available

(Critchley and Mutunga, 2003; Desta, 2005; Mati, 2006; Onduru and Muchena, 2011 in Knop et al., 2012)



Olive trees grown in planting pits in Morocco. (HP. Liniger)



Planting pits (*tassa*) before planting and rainy season, Niger. (HP. Liniger)



*Tassa* filled with rainwater in Niger. (W. Critchley)



Land user tending his sorghum crops in a field prepared with *tassa*. (P. Benguerel)

## Microbasins and basins

These MicroWH practices consist of different shapes of small basins, surrounded by low earth bunds. They channel runoff to the lowest point of the basin where it infiltrates and is taken up by plants. They are of different types:

**Negarim** are small diamond-shaped runoff basins, surrounded by low earth bunds. Runoff infiltrates at the lowest apex, where the trees are planted. Reported sizes of *negarim* are 100-250 m<sup>2</sup> in Israel and up to 400 m<sup>2</sup> in India. As 15-90% of rainfall may be harvested as runoff and used for the tree crop, the catchment to cropping area ratio ranges between 3:1 and 10:1; in flatter catchments and drier areas this may be up to 25:1. They are applied on sloping land (1-20%), however are commonly found on slopes of 1-5% in areas of 150-500 mm/y of rainfall. In the Middle East, *negarim* are used for fruit trees, especially apricots, olives, almonds, grape vines, pomegranates and pistachios; but they are also used for the establishment of fodder bushes and indigenous trees.

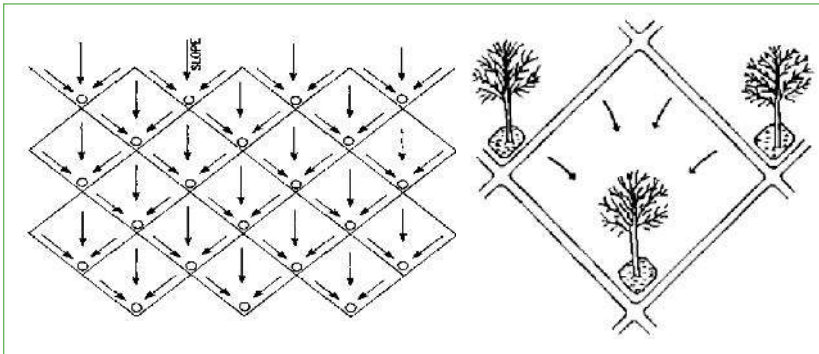

Left: Arrangement of several *negarim* (Critchley and Siegert, 1991)  
Right: Close-up of a single *negarim* (in Schauwecker, 2010)

**Meskat** is rectangular shaped runoff basin. It consists of a catchment area called *meskat* of about 500 m<sup>2</sup> in size, and a cropping area called *mankaa* of about 250 m<sup>2</sup> (C:A ratio of 2:1). The entire system is surrounded by an approximately 20 cm high bund, and provided with spillways to allow runoff to flow into the *mankaa*. A *meskat* can have more than one *mankaa* arranged in series (see figure below). Surplus runoff spills over one *mankaa* to the other. *Meskats* are suitable on slopes of 2-15% and for areas with an annual rainfall of 200 – 400 mm. They are used for growing trees (e.g. olives, figs, dates), grapes and cereals (barley and wheat).

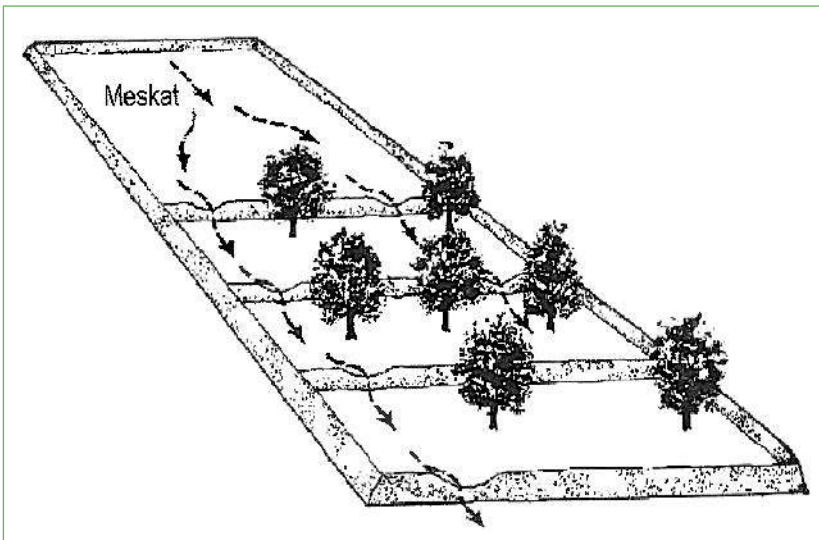

*Meskat* microcatchment in Tunisia (Prinz, 1996).



Microcatchments for tree planting, Ethiopia. (HP. Liniger)



Microbasins or trenches (*tranchées*) in Niger. (HP. Liniger)



*Negarim* for acacia trees in Turkana, Kenya. (HP. Liniger)

### Example: *Meskats* in Tunisia

The *meskat* system is a traditional MicroWH which is only used for tree cropping. In Tunisia it covers around 300,000 ha where olive trees, mainly, are cultivated in the integrated *mankaa* plots. They are applied in areas with 200–400 mm annual rainfall and slopes from 2–15% (Taamallah, 2010).



*Meskats* with olive trees in the zone of Msaken, Sousse, Tunisia (H. Taamallah).

**Triangular / V-shaped bunds:** Very similar to *negarim*, these earthen bunds of about 0.5 m in height enclose a pit in the apex, where the water is stored until it infiltrates into the soil. The structures are about 1–7 m wide and they are usually aligned in staggered rows. The tips of the basins need to be on the contour. The C:A ratio is about 5:1. They are widely used for tree establishment: for almonds, apricots, peaches, pistachio, olives or pomegranate trees, and for fodder bushes. Generally they are applied on slopes up to 20% in areas with more than 300 mm annual rainfall.

**Semi-circular bunds** are usually made of earth or stone and have commonly a diameter of 2-8 m (up to 12 m). The bund tips are set on the contour line, facing upslope. Bunds are 30-50 cm high. They are built in a staggered sequence over a plot; that is the second line catches runoff that flows between the structures in the line above; and so on. The C:A ratio ranges between 1:1 and 3:1. In dry conditions, the bunds are bigger. In wetter conditions, more bunds of smaller radius are constructed per hectare. They are applied on slopes up to 15%, however earthen bunds are rarely used on slopes steeper than 5%, receiving more than 300 mm/y of rainfall. Larger and more widely spaced half-moons, as these bunds are called (French: *demi-lunes*) are mainly used for grazing land rehabilitation or fodder production. Small and closely spaced half-moons are used to grow trees and shrubs. In the Sahel they are often used to produce pearl millet. Where they are employed to grow trees for agroforestry systems with a single pit excavated at the lowest point, they effectively act as *negarim*.



Triangular (V-shaped) stone bund. (Benli, 2012)



Semicircular bunds with olives collecting water. (T. Oweis)



Planted semi-circular bund (Rocheleau et al., 1988 in Oweis et al., 2012).

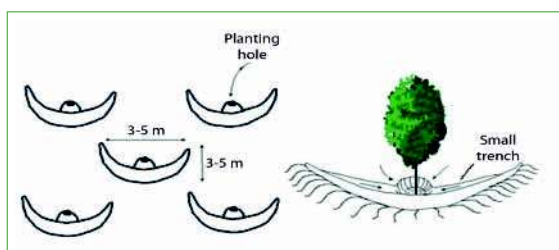

Layout of a semi-circular bund system (Mati, 2005)



Eyebrow terrace for tree planting, India. (HP. Liniger)

**Eyebrow terraces:** Microbasins which supply single trees or bushes with runoff on hillsides are sometimes termed eyebrow terraces. They are also known as 'platform terraces' as their cultivated area is kept level. The catchment size is 5–50 m<sup>2</sup> and the cultivated area 1–5 m<sup>2</sup>. This technology can be applied on slopes of up to 50%; the steeper the gradient, the more the bunds have to be reinforced by stone (where available). Eyebrow terraces can be applied in areas of 200–600 mm annual rainfall.

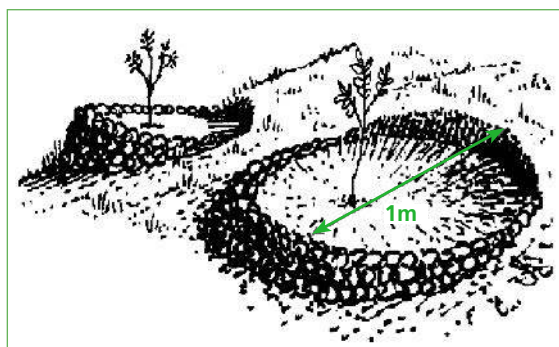

Eyebrow terrace from the side and above (Schauwecker, 2010).

#### Example: Eyebrow terraces and live fencing in Nepal

Heavily degraded grazing land in Nepal has been rehabilitated by introducing eyebrow terraces to harvest and control rainwater runoff. Grasses and trees were planted and protected through fencing. The core purpose was to re-establish vegetative cover on almost totally bare pasture land. Eyebrow terraces were excavated along with drainage trenches. Several types of grasses were planted along the ridges of eyebrow terraces and trenches. Contour hedgerows were established between the trenches and eyebrow terraces and trees were planted immediately below the pits (N. Guedel in WOCAT, 2012).

**Vallerani-type basins (mechanised *demi-lunes*):** Mechanised *demi-lunes* can be constructed by two types of modified tractor ploughs: the “train” and the “dolphin”. The “dolphin” plough creates crescent-formed microbasins at a rate of up to 5,000-7,000 per day, 400 microbasins/ha. A microbasin is 4-5 m long, 40 cm wide and 40 cm deep. It has a water-catchment capacity of about 600 litres. The reported rates of tree establishment are very high. The use of this special plough can be economic if large areas have to be treated and if quick action in sparsely populated regions is required: for example to avoid imminent desertification. The plough has been used for afforestation and pasture improvement in the Mediterranean, African and Asian countries. This system can be applied in areas of 100-600 mm annual precipitation and on slopes of 2-10% gradient.



Vallerani microbasins (fully mechanised). ([www.vallerani.com](http://www.vallerani.com)).

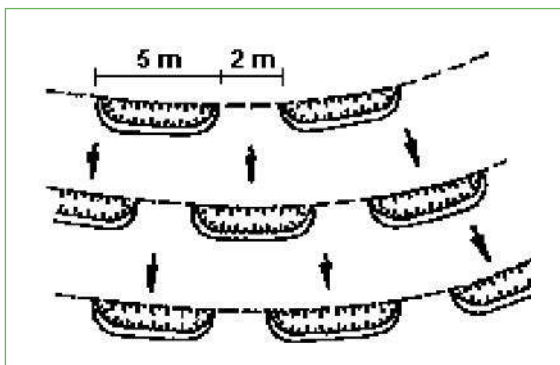

Fully mechanised Vallerani microbasins (Prinz, 1996).



Vallerani microcatchments. (W. Critchley)

### Cross-slope barriers

There are various types of cross slope barriers: vegetative, earthen (often combined with vegetative) and stone barriers.

**Permanent vegetative barriers and strips:** are made of grasses, shrubs or trees (often combined) to reduce soil loss and increase infiltration. It is a technology without structural measures that can be applied on gentle slopes as well as on steep slopes. The width of grass strips ranges from 0.5 to 1.5 m. On steep slopes the width ranges from 2 to 4 m. Trees and shrub strips are generally wider up to 5-10 m. Since vegetative strips are usually laid along the contours, the distance between them is dictated by the slope of the land. On gentle sloping land, the strips are spaced at 20-30 m, while on steep land the spacing may be 10-15 m. This practice works well in small-scale as well as in large-scale systems. Vegetative strips can also provide firewood and fodder for livestock if palatable varieties of grass or densely spaced bushes are used (cut and carry). They are the least costly or labour demanding type of cross-slope barriers. They are a popular and easy way to ultimately “terrace” land, especially in sub-humid areas, as over time soil eroded upslope is trapped by the vegetation.



Runoff strips for field crops, Syria (T.Oweis)

“Tiger bush” (*brousse tigrée*) is a naturally occurring variation of vegetative strips that harvest water. It consists of alternating bands of trees or shrubs, separated by bare ground or low herb cover, that run roughly parallel to contour lines of equal elevation. They occur on low slopes in arid and semi-arid regions, such as in Australia, Sahelian West Africa, and North America. In drylands single trees and shrubs with grass cover under the canopy also form natural barriers and WH systems. They collect water from bare soil upslope of the trees and bushes. On the bare soil (between the trees) 80 – 90% of the rains end up as runoff. The trees and grasses collect the runoff and accumulate it in the soil and thus profit from the bare areas around them.



Trees and grass collect runoff from bare soil and store it in the soil under tree canopy. (HP. Liniger)

**Cultivated strips:** On gentle slopes alternating cropping strips along the contour are built: the upper one is used as a catchment and the lower one is cropped. The width of the cropped strip ranges from 1 – 3 m. The C:A ratio is usually 1:1 but can reach 1:5 depending on rainfall and the crop. Often on the sides and the lower end of the cropped area soil bunds are constructed to impede runoff from the cropped area. Cultivated strips are used on flat land or on gentle slopes of up to 4% with at least 1 m deep soils and that receive rainfall of more than 200 mm/y.



Aerial view of a brousse tigrée. Average distance between vegetated strips 50 m, Parc “W”, Niger. (N. Barbier)

**Tied earth ridges:** Small earth ridges, with furrows between them, blocked with earth ties every 0.5 – 1.0 m are termed ‘tied ridges’. On gentle slopes typical dimensions of the ridges are 20 – 25 cm height and 0.5 – 1.5 m spacing between ridges depending on rainfall and the crop to be grown. On flat land compacted bunds and ridges are constructed to generate runoff with a spacing of 1.2 to 10 m and a ridge height of 30 – 100 cm, depending on rainfall, crop to be grown and soil characteristics. Runoff is collected between the ridges. The catchment to application area ratio (C:A) ranges from 1:1 to 5:1. This type of ridge needs maintenance every cropping season and has to be rebuilt about every 5-6 seasons. Tied ridges are often considered an in situ form of water conservation, though where the ridges are large it can be argued that they act themselves as a form of microcatchment.

**Contour earth bunds - down-slope** (*fanya chini*: “throw it downwards” in Kiswahili): Construction of earthen bunds (in Southern Africa they are sometimes referred to as ‘ridges’) is along the contour by excavating a channel and creating a small ridge down slope. Occasionally, the earth used to build the bund is taken from both above and below the structure. They may be reinforced with vegetation or stone for stabilization. Bunds are gradually built up by annual maintenance and adding soil to the bund. The main benefit is that long slopes are broken down into smaller ‘compartments’ with less steep slopes. Erosion is reduced and runoff has more opportunity to infiltrate into the soil between the bunds. Before the bunds lead to the development of flat benches, they effectively form microcatchments with runoff concentrating upslope of the structures. To avoid lateral water flow and breaching of the bunds cross ties are constructed at regular intervals. Such bunding systems are used in areas of 300–600 mm annual rainfall on slopes of 1-25%. They can be applied on all types of relatively permeable soils (e.g. alluvial, red, laterite, brown and, shallow and medium black soils) but not on clays or vertisols. While this system is often used for the cultivation of annual crops such as maize (*Zea mays*), tef (*Eragrostis tef*) or beans (*Vicia faba L*), more water-demanding crops, such as bananas, fruits and vegetables may be planted where runoff concentrates – immediately above (and sometimes just below) the bund. Contour bunds may be used specifically as a water harvesting technology for tree establishment.

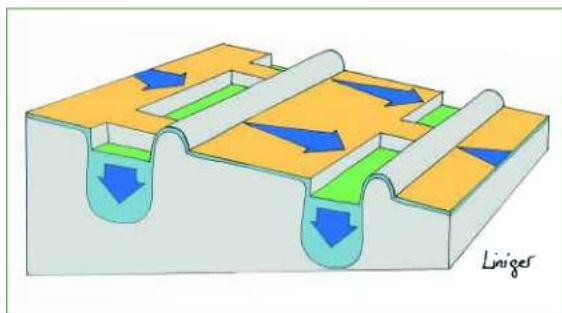

*Fanya chini* contour earth bunds.

**Contour earth bunds - up-slope** (*fanya juu*: “throw it upwards” in Kiswahili) a variation of contour bench terraces and are typically constructed on slopes 5-20%. They are constructed by digging a trench and throwing soil up-slope to form a bund. The trench is usually 50–60 cm deep and may have cross-ties at 10 m intervals. A small ledge or ‘berm’ is left between the ditch and the bund to prevent soil sliding back. *Fanya juu* involve more labour than *fanya chini*. In semi-arid areas they are normally constructed to harvest and conserve rainfall, whereas in sub-humid zones they may be laterally graded to safely discharge excess runoff. The bunds (risers) are often stabilized with fodder grasses. Over time forward sloping *fanya juu* terraces can develop into level contour bench terraces due to contour tillage or soil erosion on the “terraces”. Apart from Kenya, Ethiopia and Tanzania, records of *fanya juu* terraces also exist from Zimbabwe.



Tied ridges with mulch in the furrows in Kenya (HP. Liniger).



Down-slope contour bunds in Rajasthan, India (HP. Liniger).



Down-slope contour bunds in Cape Verde (HP. Liniger).



*Fanya chini* and pits for banana planting, Muranga, Kenya (HP. Liniger)



*Fanya juu* terraces with well-established grass strips in a semi-arid area. Upslope contour bunds have developed over time into bench terraces (HP. Liniger).



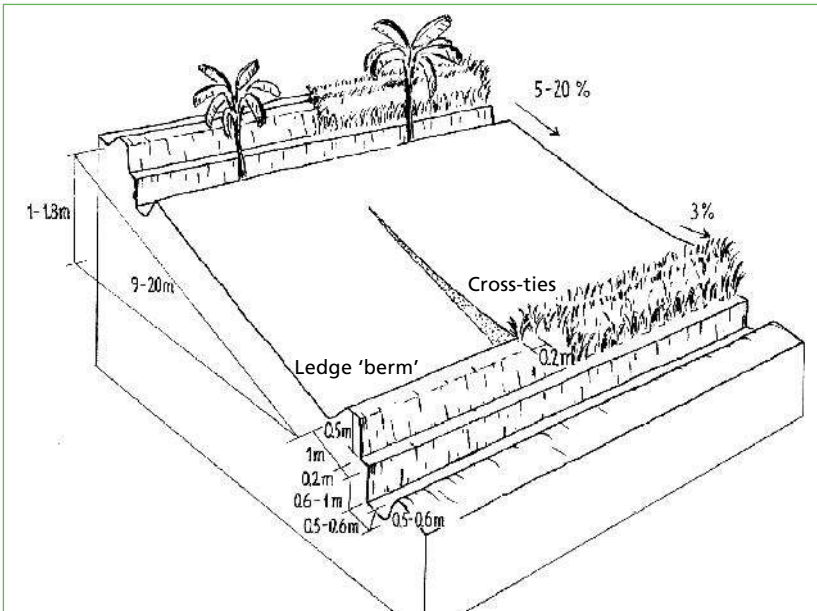

Technical drawing of *fanya juu* (M. Gurtner in Liniger et al., 2011).



Close view of a *fanya juu* grass strip in Kenya. (HP. Liniger)



Stone bund slowing down runoff with more water infiltration and earlier germination of maize. (HP. Liniger)



Stone lines on grazing land accumulating water in the soil under the stones, Niger. (HP. Liniger)

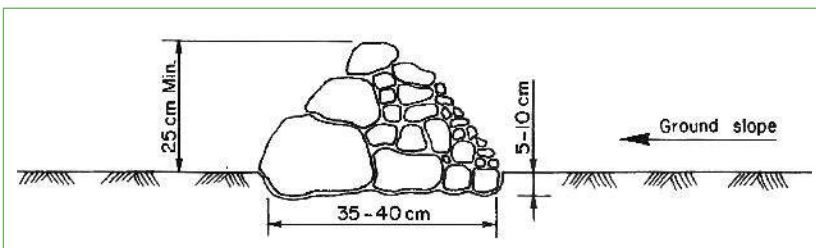

Stone bund: height up to 25 cm; length up to 35-40 cm (Critchley and Siegert, 1991).



Forward sloping terraces in Rwanda. (HP. Liniger)

**Stone lines / bunds ("cordon de pierres"):** Stone lines / bunds are used either as a soil conservation measure on slopes  $>5\%$  (bund) or for water harvesting on slightly sloping plains ( $< 5\%$ ) in semi-arid regions (line). Hence, stone lines combine elements of macrocatchment and microcatchment technologies depending on runoff collected either from an external catchment or in-field. A stone line is typically 25 cm high and has a base width of 35-40 cm. It is constructed of a mixture of small and large stones along the contour and across a field. Smaller stones are placed upslope and the larger ones underneath to slow down runoff, trap fertile soil sediment and enhance water infiltration. The distance between the lines depends on the slope and how many stones are available. The recommended spacing between lines is 20 m for slopes less than 1%, 15 m for slopes of 1-2%. Stone lines are easy and cheap to construct, provided that stones are locally available. Stone lines are common throughout Africa, in both dry and humid areas. They are used wherever there are loose stones in the field. In the Sahel (especially Burkina Faso and Niger), they are small – at most three stones wide, and one or two high.

**Contour forward sloping bench terraces** are constructed or develop over time from vegetative strips, contour earth bunds and stone bunds on steeper slopes (up to 60%). This technology combines soil and water conservation with WH. Runoff is harvested from the sloping non cropped area between the terraces (C:A ratio 1:1 – 10:1). This type of terraces is used in areas with annual rainfall between 200-600 mm/y and is mainly used for trees and bushes and less for field crops.

## Spread and applicability

### Spread

**Pitting systems:** e.g. Burkina Faso (*zai*), Niger (*tassa*), Nigeria (*kofyar*), Tanzania (*chololo*, *ngoro* and *matengo*), Kenya (*katumani*, *tubukiza*), Sudan (*magun*), Uganda, Zambia in Sub-Saharan Africa and Kyrgyzstan (*yamka*) in Central Asia.

**Microbasins:** e.g. Botswana, Burkina Faso, Chad, Egypt, Kenya, Morocco, Niger, Senegal, Sudan, Tunisia (*meskat*), Israel (*negarim*), Jordan, Syria, China, India, Nepal, Tajikistan

**Vallerani type basins:** Burkina Faso, Chad, China, Egypt, Jordan, Kenya, Morocco, Niger, Senegal, Sudan, Syria and Tunisia.

**Cross slope barriers:** widespread

- Vegetative barriers / strips: e.g. Burkina Faso, Senegal, Syria
- Contour bunds: Sub-Sahara Africa (e.g. Botswana, Burkina Faso, Cameroon, Ethiopia, Ghana, Kenya, Malawi, Mali, Niger, Nigeria, Senegal, Somalia (saad system), South Africa, Sudan Tanzania, Uganda, Zambia, Zimbabwe), Afghanistan, China, India Nepal, Pakistan, Thailand, Philippines, Peru, Syria, Tajikistan, Tunisia, etc
- Stone lines: Sub-Saharan Africa (e.g. Burkina Faso, Kenya, Mali, Niger, Senegal), Afghanistan, Pakistan, Tajikistan, etc

### Applicability

**Land use:** Annual cropland with cereals (sorghum, millet, maize), leguminous grains / pulses (cowpeas, pigeon peas etc.), vegetables (tomatoes, onion, potatoes, etc.). Often used for the cultivation of tree crops, sometimes also for fodder bushes and forest trees.

**Water use:** To increase water availability in the root zone and hence plant production. The combination of planting pits with stone bunds is used in West Africa to rehabilitate degraded and crusted lands and bring them into cultivation. These technologies should be combined with technologies which reduce runoff and evaporation loss (through soil cover, shade and wind protection and weed control) and enhance soil fertility (such as manuring and microdosing with fertilizers) to further increase yields.

**Climate:** Mainly applied in semi-arid regions with 250–750 mm annual rainfall. In addition, these practices can sometimes also be found in sub-humid to humid areas. Vegetative strips perform better in more humid climate.

**Terrain:** MicroWH practices can be applied on steep slopes as well as in flat areas, as long as there is adequate runoff available. While the different types of pits are applied in flat areas, cross-slope barriers including bunds, trenches and terraces are more commonly used on sloping land.

**Scale:** Water is collected from small catchment areas, usually 10–500 m<sup>2</sup>, within the boundaries of individual farms and within the agricultural land.

**Level of mechanisation:** Usually manually constructed, though in the case of Vallerani micro-basins, mechanized.

**Land ownership and land / water use rights:** MicroWH practices are often applied by individual land users especially for crop production, however sometimes also on state owned or communal land e.g. in the case of afforestation. The small catchment areas can be easily controlled by individual land users, which makes the systems easy to adapt and replicate. Since water is stored in the soil and has its source / origin in-field, each land user can apply the system without a community being involved or conflicts with neighbours over the water use.

**Skill / knowledge requirements:** While the implementation of MicroWH practices requires little knowledge by the land users, agricultural advisors need to have a medium level of know-how.

**Labour requirements:** Medium to high labour requirements: pitting systems especially require sufficient labour availability as they have to be re-dug every cropping season. However compared to land preparation of the entire area without micro-catchments the overall workload and labour input is concentrated onto the area where plants are effectively growing.

#### Land use

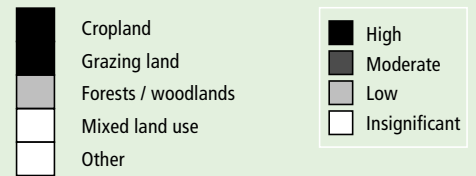

#### Water use

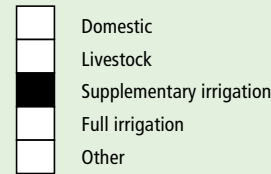

#### Climate

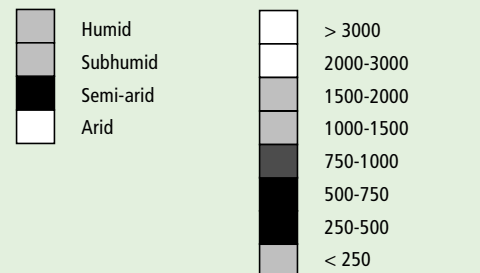

#### Slope (%)

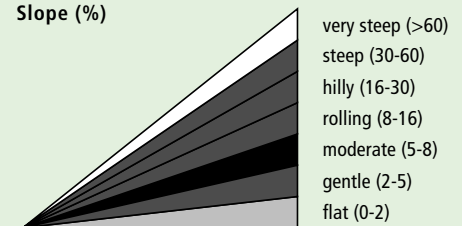

#### Scale

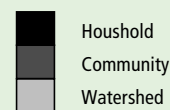

#### Land ownership

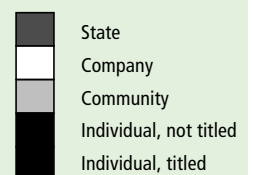

#### Mechanisation

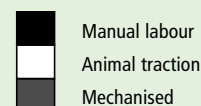

#### Market orientation



#### Required labour

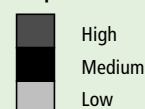

#### Required know-how

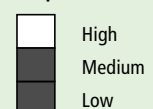

## Economics

### Costs

#### Labour costs for MicroWH

Practice	Country	Cost (US\$/ha)	
		Establishment	Maintenance per year
Zai and contour bunds <sup>1</sup>	Burkina Faso	80 – 175	30
Ngoro <sup>2</sup>	Kenya	45 – 55	15 – 20
Stone bunds <sup>2</sup>	Kenya	36 – 62	12
Fanya juu <sup>2</sup>	Kenya	54	18
Planting pits and stone lines <sup>3</sup>	Kenya	77 – 175	21
Katamani <sup>3</sup>	Kenya	100 – 150	
Banana pits <sup>3</sup>	Kenya	2177	81
Meskat <sup>4</sup>	Tunisia	900	–
Vetiver strips <sup>5</sup>	South Africa	140	25
Cistern <sup>4</sup>	Tunisia	400 / structure	65 / structure

<sup>1</sup> Van Steenberg et al., 2011; <sup>2</sup> for fanya juu, use of additional tools is required; life span of stone bunds and fanya juu is 10 years, of ngoro pits 2 years; adapted from Ellis-Jones and Tengberg, 2000; <sup>3</sup> Knoop et al., 2012; <sup>4</sup> Taamallah, 2010; <sup>5</sup> WOCAT, 2012.

<sup>2</sup> and <sup>3</sup> labour costs have been based on US\$ 1.0 per day, although these vary from US\$ 0.75 – 1.25 per day in the different case studies;

#### Cost of selected MicroWH technologies in Niger

MicroWH practice	Indicative costs US\$/ha
Stone lines	31
Stone lines with direct seeding	44
Earth bunds (mechanised)	137
Earth bunds (manual)	176
Half-moon for crops	111
Half-moon for trees	307
Zai planting pits	65

(Projet d'Aménagement Agro-Sylvo-Pastoral Nord Tillabéry (PASP); Projet Développement Rural Tahoua (PDRT) in Liniger et al., 2011).

### Production benefits

Crop	Yield without MicroWH (t/ha)	Yield with MicroWH (t/ha)	Yield gain (%)
Maize (grain yield) Kenya <sup>1</sup>	0.16 – 0.56	Stone lines: 0.41 – 1.28	230 – 250
Millet Burkina Faso <sup>2</sup>	0.15 – 0.3	Zai + manure: 0.4 (poor rainfall) 0.7 – 1 (high rainfall)	30 – 400
Sorghum (grain yield) Burkina Faso <sup>2</sup>	0 (due to harsh soil conditions, sorghum crop failed)	Half-moon alone: 0.04 Half-moon + manure: 1.61 Half-moon + compost: 1.0	
Sorghum Burkina Faso <sup>3</sup>	0.08	Zai and stone bunds: 0.3 – 0.4 (year of low rainfall) 1.5 (year of good rainfall)	375 – 500

<sup>1</sup> Wakindiki and Ben-Hur, 2002; <sup>2</sup> Zougmore et al., 2003; <sup>3</sup> Van Steenberg et al., 2011; spin-off benefit: market for manure.

#### Costs of MicroWH per ha (median)

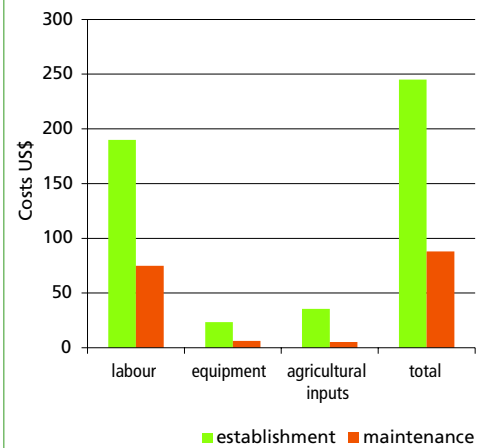

Costs for establishment of MicroWH structures range from 95 US\$/ha for Vallerani microbasins to 809 US\$/ha for chololo pits. Mainly labour is required and few other inputs such as agricultural (seeds, compost, fertilizer, etc.). Labour days can vary considerably and range between 80-250 person days (PD)/ ha.

Source: 8 case studies from the WOCAT database (WOCAT, 2012).



Large-scale olive production using different types of micro- and macrocatchments, Morocco. (HP. Liniger)

#### Examples: Production benefits from planting pits

In Burkina Faso after the development of zai pits the farmers were able to rehabilitate their land and expand the size of their farms where nothing grew before. Thus, there was basically zero crop yield without pits, while with pits, the yield reached 0.3 – 0.4 t/ha in a year of low rainfall, and up to 1.5 t/ha in a year of good rainfall. Using half-moons treatments, sorghum grain yields reached above average (compared to normally ploughed fields) yields on completely degraded soils. Without half-moon micro-basins sorghum failed completely (Zougmore et al., 2003).

Similar studies on ngoro pits in Tanzania revealed that 2 m wide pits had the highest maize grain yield (1.85 t/ha) compared to 1 m wide (1.44 t/ha) and 1.5 m wide pits (1.66 t/ha) (Malley et al., 2004).

Survival rate of fodder shrubs planted in combination with MicroWH structures in Syria was 3 – 4 times higher than for fodder shrubs alone in high as well as in low rainfall years (Somme et al., 2004).

## Impacts

Benefits	Farm level / household level	Community / watershed / landscape level
Production / Economic	<ul style="list-style-type: none"> <li>+++ increased crop yield</li> <li>++ enhanced water availability for plants</li> <li>++ increased fodder production</li> <li>++ increased farm income</li> <li>+ increased wood production</li> <li>+ diversification of production</li> </ul>	<ul style="list-style-type: none"> <li>++ reduced risk of production failure</li> </ul>
Ecological	<ul style="list-style-type: none"> <li>+++ improved water availability</li> <li>+++ improved water infiltration</li> <li>+++ increased net soil moisture</li> <li>+++ reduced runoff</li> <li>+++ reduced soil erosion and soil loss</li> <li>++ can be used for rehabilitation of highly degraded land</li> <li>+ improved soil cover</li> <li>+ increased soil organic matter and soil fertility</li> <li>+ sediment traps for nutrients</li> </ul>	<ul style="list-style-type: none"> <li>+++ reduced flooding and sediment loads for rivers and reservoirs</li> <li>+++ reduced degradation and sedimentation</li> </ul>
Socio-cultural	<ul style="list-style-type: none"> <li>++ improved conservation knowledge</li> <li>++ no conflicts over water use</li> </ul>	<ul style="list-style-type: none"> <li>++ improved food security</li> </ul>
Off-site		<ul style="list-style-type: none"> <li>++ protects rivers and reservoirs from sedimentation</li> </ul>

Importance: +++ high, ++ medium, + low

	Constraints	How to overcome
Production / Economic	MicroWH alone might not be sufficient to improve crop yield	→ combine with improved soil fertility management (microdosing and composting)
	inadequate maintenance of MicroWH systems can lead to soil erosion	→ make sure that appropriate maintenance is used and organise training
	insufficient availability of manure to improve fertility reduces potential of plant production	→ improve access to market for inputs and equipment
	limited lifespan of structures and therefore recurrent labour requirements for maintenance	→ clarify if enough labour force is available before engaging in implementing MicroWH
	loss of land (to form catchments) can be perceived as a problem for small farms	→ assess the trade-off between loss of land and increased production or reduced risk of production failure beforehand
Ecological	waterlogging can be a problem under poor drainage systems	→ check soil for drainage properties beforehand
	where grasses and shrubs form on barriers this may permit rodents to become established in the field	→ combine with biological pest control
Socio-cultural	socio-cultural conflicts concerning rehabilitated land. Some of the degraded land where there was no claim for its use, after rehabilitation people claimed this same land although they did not invest in its reclamation	→ farmer and community involvement and clarify claims and rights at the beginning of the rehabilitation activities

## Adoption and upscaling

### Adoption rate

In general adoption rates remain low. Land users hesitate to invest time and money in MicroWH without security of land and limited access to local markets where they can sell surpluses. However, some MicroWH technologies like *zai* have been widely adopted with (and in some areas without) external support.

### Enabling environment

**Policy environment:** Conducive laws and by-laws are required to govern use of land and water resources by different users – especially herders in relation to crop producers.

**Land and water tenure:** Tenure security is the crucial issue that will determine if farmers adopt, adapt and implement MicroWH practices or not.

**Technical support and capacity development:** For MicroWH a low level of material and technical support is needed. However, major challenges lie in improving nutrient management, through integrated approaches (microdosing as well as manuring / composting and mulching), and in stronger mechanisation, for which technical and material support is required.

**Access to financial services:** The investment costs for cross-slope barriers (for example) are considerable; hence land users should have access to microcredit to enhance self-financing. The misuse of incentives for participating communities, especially the uncritical use of food-for-work, which induces a culture of dependence, should be avoided. Apart from incentives in the form of microcredit and tools, there is also a need for motivational campaigns, awareness-raising, demonstrations, training and extension work.

**Availability of labour:** MicroWH practices are perceived to have a high labour requirement and thus, labour availability is considered as a key factor determining the likelihood of adopting such practices. However, considering that the planted area of a field is reduced and water and nutrients are concentrated to this area the yield harvested per labour invested increases remarkably as compared to conventional planting of the field. In some rural areas of developing countries, where outmigration especially of young people to urban centres or abroad is high, labour availability can be very limited.

**Suitable approaches:** Farmer field schools comprising group learning to build knowledge and capacity among land users is one sound approach. Neighbours' reciprocal help is also a common approach used in many countries under which neighbours take turns to assist a member of their community with labour intensive work (e.g. *hashar* in Tajikistan). An initiative to support local innovators will help identify and stimulate recent innovations.

### Feasibility and planning

The implementation of MicroWH practices first of all requires an assessment of the available labour force, materials and financial means, and accordingly the most suitable practices should be drawn up. Furthermore, in order to select the best suited practices for a given environment, a biophysical assessment of the field should be conducted. This includes crop water requirements, soil properties, rainfall data, and an estimation of the runoff coefficient. Whenever possible, existing WH practices (indigenous and innovative) should be the first to be considered – and modified in accordance with existing socio-economic and biophysical settings.

The social and economic sustainability of MicroWH practices depends largely on the involvements of all stakeholders. Communities need to be involved in planning at all stages in order to ensure the maintenance of the practices and sharing of benefits. Planning should also consider the potential and possibilities for fertility management, and investigate the availability of organic manure or compost to be added to the fields in addition to the MicroWH practices.

Monitoring and evaluation should be an integral part in order to further improve production and provide the land users with information on how to adapt their systems.

Enabling environment: key factors for adoption	
Inputs, material	++
Incentives, credits	+
Training and education	+
Land / water use rights	+++
Access to markets for inputs and outputs	++
Research	+
Genuine ownership on the part of communities	++

Importance: +++ high, ++ medium, + low, +/- neutral

Feasibility and planning: key factors for implementation	
Assessing water quantity to be harvested	+++
Assessing water quality	+/-
Estimating water needs	++
Site assessment	++
Financial aspects	++
Environmental impact assessment	+/-
Land / water use rights	++
Neighbourhood relations	+/-
Community involvement	+
Social and gender aspects	+/-
Official governmental approval	+/-

Importance: +++ high, ++ medium, + low, +/- neutral



Large-scale planning of government projects using micro-catchments for reforestation, Loess Plateau, China. (HP. Liniger)



Training of land users for setting up level ditches with *fanya juu* terraces for water harvesting in dry areas Laikipia, Kenya. (HP. Liniger)

## References

- African Development Bank. 2009. Rainwater Harvesting Handbook: Assessment of Best Practises and Experience in Water Harvesting. African Development Bank, Tunis. <http://www.rwsn.ch/documentation/skatdocumentation>.
- Ali, A., Oweis, T., Rashid, M., El Naggar, S. and A. Aal. 2007. Water harvesting options in the drylands at different spatial scales. *Land Use and Water Resources Research* 7:1-13.
- Benli, B. 2012. Rain Water Harvesting. United Nations Development Programme (UNDP). Presentation available from [http://www.unep.org/fileadmin/DAM/env/water/meetings/TF\\_EWE/2nd\\_meeting/power\\_points/Water\\_Harvesting.pdf](http://www.unep.org/fileadmin/DAM/env/water/meetings/TF_EWE/2nd_meeting/power_points/Water_Harvesting.pdf)
- Biazin, B., Sterk, G., Temesgen, M., Abdulkedir, A. and L. Stroosnijder. 2012. Rainwater harvesting and management in rainfed agricultural systems in sub-Saharan Africa: A review. *Physics and Chemistry of the Earth, Parts A/B/C* 47-48 139–151.
- Botoni, E., Reyssset, M.B., Ndiaye, O. et S. Ouedraogo. 2009. Récupération des sols fortement dégradés à des fins sylvo-pastorales: une évaluation quantitative des aménagements mécaniques à partir de la charrue Delfino réalisés par l'ONG REACH au Burkina Faso. Comité permanent Inter- États de Lutte contre la Sécheresse dans le Sahel (CILSS) et Commission Européenne au Burkina Faso FERSOL.
- Critchley, W. and K. Siegert. 1991. Water harvesting. A Manual for the Design and Construction of Water harvesting Schemes for Plant Production. FAO, Rome. <http://www.fao.org/docrep/U3160E/U3160E00.htm#Contents>
- Ellis-Jones, J. and A. Tengberg. 2000. The impact of indigenous soil and water conservation practices on soil productivity: Examples from Kenya, Tanzania and Uganda. *Land Degradation & Development* 11(1):19-36.
- Ibraimo, N. and P. Mungambe. 2007. Rainwater Harvesting Technologies for Small Scale Rainfed Agriculture in Arid and Semi-arid Areas. Department of Rural Engineering, Faculty of Agronomy and Forestry Engineering, University of Eduardo Mondlane, Mozambique.
- Knoop, L., Sambalino, F. and F. Van Steenbergen. 2012. Securing Water and Land in the Tana Basin: a Resource Book for Water Managers and Practitioners. 3R Water Secretariat. Wageningen, The Netherlands.
- Liniger, H. and W. Critchley (eds). 2007. Where the land is greener: case studies and analysis of soil and water conservation initiatives worldwide. *World Overview of Conservaton Approaches and Technologies (WOCAT)*.
- Liniger, H., Mekdaschi Studer, R., Hauert, C. and M. Gurtner. 2011. Sustainable Land Management in Practice. Guidelines and Best Practices for Sub-Saharan Africa. TerrAfrica, World Overview of Conservation Approaches and Technologies (WOCAT) and Food and Agriculture Organization of the United Nations (FAO).
- Mati, B. M. 2005. Overview of water and soil nutrient management under smallholder rainfed agriculture in East Africa. Working Paper 105. International Water Management Institute (IWMI), Colombo, Sri Lanka.
- Malley, Z.J.U., Kayombo, B., Willcocks, T.J. and P.W. Mtakwa. 2004. Ngoro: an indigenous, sustainable and profitable soil, water and nutrient conservation system in Tanzania for sloping land. *Soil and Tillage Research* 77(1):47-58.
- Mupangwa, W., Love, D. and S. Twomlow. 2006. Soil-water conservation and rainwater harvesting strategies in the semi-arid Mzingwane catchment, Limpopo Basin, Zimbabwe. *Physics and Chemistry of the Earth* 31(15-16):893-900.
- Mutunga, K. and W. Crichley. 2001. Farmers' Initiatives in Land Husbandary: Promising Technologies for the Drier Areas of East Africa. Regional Land Management Unit (RELMA), Swedish International Development Cooperation Agency (Sida). RELMA Technical Report Series 27. Nairobi.
- Oweis, T.Y., Prinz, D. and A.Y. Hachum. 2012. Water Harvesting for Agriculture in the Dry Area. ICARDA, CRC Press/ Balkema, Leiden, the Netherlands.
- Prinz, D. 2001. Water Harvesting for Afforestation in Dry Areas. Paper read at 10th International Conference on Rainwater Catchment Systems, Mannheim, 10-14 Sept. 2001, at Mannheim.
- Prinz, D. 1996. Water harvesting: Past and Future. In: Pereira L.S., (ed). Sustainability of Irrigated Agriculture. Proceedings, NATO Advanced Research Workshop, Vimeiro, 21 – 26.03.1994. Balkema, Rotterdam.
- Prinz, D. and A.H. Malik. 2002. More Yield with Less Water: How Efficient can be Water Conservation in Agriculture? Paper read at 5th International EWRA Conference on Water Resources Management in the Era of Transition, Athens, Greece, 4- 8 September 2002.
- Rockström, J., Folke, C., Gordon, L., Hatibu, N., Jewitt, G., Penning de Vries, F., Rwehumbiza, F., Sally, H., Savenije, H. and R. Schulze. 2004. A watershed approach to upgrade rainfed agriculture in water scarce regions through water system innovations: an integrated research initiative on water for food and rural livelihoods in balance with ecosystem functions. *Physics and Chemistry of the Earth* 29:1109-1118.
- Somme, G., Oweis, T., Abdual, A., Bruggeman, A. and A. Ali. 2004. Micro-catchment Water Harvesting for Improved Vegetative Cover in the Syrian Badia. International Center for Agricultural Research in the Dry Areas (ICARDA). Aleppo, Syria.
- Taamallah, H. (ed). 2010. Gestion durable des terres en Tunisie: bonnes pratiques agricoles. Land Degradation Assessment in Drylands (FAO-LADA), World Overview of Conservation Approaches and Technologies (WOCAT) and Institut des Régions Arides (IRA), Médenine.
- Van Steenbergen, F., Tuinhof, A. and L. Knoop. 2011a. Transforming Lives Transforming Landscapes: the Business of Sustainable Water Buffer Management. 3R Water Secretariat. Wageningen, The Netherlands.
- Wakindiki, I.I.C. and M.Ben-Hur. 2002. Indigenous soil and water conservation techniques: effects on runoff, erosion, and crop yields under semi-arid conditions. *Australian Journal of Soil Research* 40(3):367-379.
- WOCAT (World Overview of Conservaton Approaches and Technologies). 2012. WOCAT Database: Technologies. <http://cdewocat.unibe.ch/wocatQT/index.php>.
- Zaal, F. and R.H. Oostendorp. 2002. Explaining a miracle: intensification and the transition towards sustainable small-scale agriculture in dryland Machakos and Kitui Districts, Kenya. *World Development* 30(7):1271-1287.
- Zougmoré, R., Zida, Z. and N.F. Kambou. 2003. Role of nutrient amendments in the success of half-moon soil and water conservation practice in semiarid Burkina Faso. *Soil & Tillage Research* 71(2):143-149.

## Complementary references:

- Anderson, I.M. and M. Burton. 2009. Best Practices and Guidelines for Water Harvesting and Community Based (Small Scale) Irrigation in the Nile Basin. Water Harvesting Report. Part I – Best Practices in Water Harvesting. Part I – Best Practices in Water Harvesting. Appendices. Part II – Guidelines for the implementation of best practices in Water Harvesting. Part II – Guidelines for the implementation of best practices in Water Harvesting. Appendix A: List of Reference Material. Kent, Nile Basin Initiative. Efficient Water Use for Agricultural Production Project (EWUAP).
- Critchley, W. 2009. Soil and Water Management Techniques in Rainfed Agriculture: State of the Art and Prospects for the Future. Background note prepared for the World Bank, Washington D.C.
- Desta, L., Carucci, V., Wendem-Agenehu, A. and Y. Abebe (eds). 2005. Community Based Participatory Watershed Development, Part 1: A Guideline, Part 2: Annex. Ministry of Agriculture and Rural Development, Addis Ababa, Ethiopia.
- Duveskog, D. 2003. Soil and Water Conservation with a Focus on Water Harvesting and Soil Moisture Retention. A study guide for Farmer Field Schools and Community-based Study Groups. Harare, FARMESA.

FAO (Food and Agricultural Organization of the UN). 2000. Manual de captación y aprovechamiento del agua de lluvia: Experiencias en América Latina. Zonas áridas y semiáridas No. 13. Santiago, Chile, Organización de las Naciones Unidas para la Agricultura y la Alimentación (FAO), Oficina Regional de la FAO para América Latina y el Caribe. <http://ftp.fao.org/docrep/fao/010/ai128s/ai128s00.pdf>

Hai, M.T. 1998. Water Harvesting: an Illustrative Manual for Development of Microcatchment Techniques for Crop Production in Dry Areas. RELMA Technical Handbook. Nairobi, RELMA. <https://we.riseup.net/assets/4867/microcatchment%20for%20dry%20area%20crops.pdf>

Herweg, K. and E. Ludi. 1999. The performance of selected soil and water conservation measures: case studies from Ethiopia and Eritrea. *Catena* 36(1-2):99-114.

Hurni, H. 1986. Guidelines for Development Agents on Soil Conservation in Ethiopia. Ministry of Agriculture, Natural Resources Conservation and Development. Community Forests and Soil Conservation Development Department (CFSCDD). Addis Abbaba, Ethiopia.

ICIMOD. 2009. Mountain Development Resource Book for Afghanistan. International Centre for Integrated Mountain Development (ICIMOD). Kathmandu, Nepal.

IFAD. 2001. Rainwater Harvesting Design Manual for Irrigated Agriculture in Marginal Areas. International Fund for Agricultural Development (IFAD). Rome.

Junghou, W. and V. Vallerani. 2010. The Afforestation of a Pilot Area through the Application of the "Vallerani System" Technology in the Inner Mongolia Autonomous Region. Implementation Report for the Sino-Italy Cooperation Project.

LUCOP (Lutte Contre la Pauvreté). 2004. Referentiel des mesures techniques de recuperation, de protection et d'exploitation durable des terres, 2ème edition. Coopération Nigéro – Allemande. Programme Régional Tillabéri, Bureau Régional Niamey.

Mahnot, S. 2003. Water Harvesting Management: Improving Land Management in Rajasthan. SDC/Intercooperation Coordination Unit. Jaipur, India.

Orodho, A. (not dated). Tumbukiza technology: an alternative method of Napier grass production. Betuco.be.

Oweis, T.Y., Prinz, D. and A.Y. Hachum. 2001. Water Harvesting. Indigenous Knowledge for the Future of the Drier Environments. International Center for Agricultural Research in the Dry Areas (ICARDA). Aleppo, Syria.

PROWALO. 1996. La charrue Delphine: Expérimentation dans les forêts et les terroirs du Walo. Projet d'Aménagement des Forêts et de Gestion des Terroirs Villageois du Walo (PROWALO). [http://www.vallerani.com/images/Dispensa\\_illustrata\\_PROWALO-1996.pdf](http://www.vallerani.com/images/Dispensa_illustrata_PROWALO-1996.pdf)

Rocheleau, D., Weber, F. and A. Field-Juma. 1988. Agroforestry in dryland Africa. International Council for Research in Agroforestry (ICRAF). Nairobi, Kenya.

Rochette, R.M. (ed). 1989. Le sahel en lutte contre la desertification: leçons d'experiences. Comité Inter-Etats de Lutte contre la Sécheresse au Sahel (CILSS). Margraf. Weikersheim, Germany.

Schauwecker, C. 2010. A Water Harvesting Guide for Extension Workers: Water Harvesting Manual and Catalogue. Bern University of Applied Sciences, School of Agriculture, Forest and Food Sciences.

#### Audio-visual media:

AccessAgriculture. Contour bunds. Language: English. Length: 15.0 min. <http://www.accessagriculture.org/node/511/en>

IIED (International Institute for Environment and Development) and IFAD (International Fund for Agricultural Development). 2012. Series on Sustainable Land Management Technologies in sub-Saharan Africa. Videos. Directed by: William Critchley. Produced by: Josephine Rodgers (Country Wise Communication). Language: English. Length: 12 x 8 min with accompanying information sheets. <http://www.thewaterchannel.tv/>

IIED (International Institute for Environment and Development) Clips. Climate Change Adaptation Technology: Stone Lines. Language: English. Length: 7.27 min. [http://www.youtube.com/watch?v=RQkiv\\_U5AoU&feature=player\\_embedded#!](http://www.youtube.com/watch?v=RQkiv_U5AoU&feature=player_embedded#!)

IIED (International Institute for Environment and Development) Clips. Climate Change Adaptation Technology: Fanya Juu Terraces. Language: English. Length: 5:27 min. [http://www.youtube.com/watch?v=b9Z\\_wYjyBCE&feature=player\\_embedded](http://www.youtube.com/watch?v=b9Z_wYjyBCE&feature=player_embedded)

Vincent, P. 2011. Collecting rain water using Vetiver. Language: English. Length: 2.02 min. [http://www.youtube.com/watch?v=e482unvd3uc&feature=player\\_embedded#!](http://www.youtube.com/watch?v=e482unvd3uc&feature=player_embedded#!)

#### Networks:

International Rainwater Harvesting Alliance (IRHA). Focus: Global. <https://www.irha-h20.org>

World Overview of Conservation Approches and Technologies (WOCAT). Focus: Global. <http://www.wocat.net>

Centre for Science and Environment (CSE). Focus: India. <http://www.rainwaterharvesting.org>

#### Recurrent events:

SearNet International Conference. <http://worldagroforestry.org/projects/searnet/conference/>

World Overview of Conservation Approches and Technologies (WOCAT) International Workshop and Steering Meeting. <http://www.wocat.net>

#### Selected WOCAT Case Studies:

Niger: Planting pits and stone lines. QTNIG02. [http://cdewocat.unibe.ch/wocatQT/qt\\_summary.php?qt\\_id=513](http://cdewocat.unibe.ch/wocatQT/qt_summary.php?qt_id=513)

Syria: Furrow enhanced runoff harvesting for olives. QTSYR03. [http://cdewocat.unibe.ch/wocatQT/qt\\_summary.php?qt\\_id=263](http://cdewocat.unibe.ch/wocatQT/qt_summary.php?qt_id=263)

Burkina Faso: Vallerani system. QTBRK011. [http://cdewocat.unibe.ch/wocatQT/qt\\_summary.php?lang=english&qt\\_id=667](http://cdewocat.unibe.ch/wocatQT/qt_summary.php?lang=english&qt_id=667)

Kenya: Fanya juu terraces. QTKEN05. [http://cdewocat.unibe.ch/wocatQT/qt\\_summary.php?qt\\_id=473](http://cdewocat.unibe.ch/wocatQT/qt_summary.php?qt_id=473)



## Planting pits and stone lines

Niger - *Tassa avec cordon pierreux (French)*

**Rehabilitation of degraded land through manured planting pits, in combination with contour stone lines. The planting pits are used for millet and sorghum production on gentle slopes.**

The combination of planting pits (*tassa*) with stone lines is used for the rehabilitation of degraded, crusted land. This technology is mainly applied in semi-arid areas on sandy/loamy plains, often covered with a hard pan, and with slopes below 5%. These denuded plains are brought into crop cultivation by the combination of *tassa* and stone lines. Planting pits are holes of 20-30 cm diameter and 20-25 cm depth, spaced about 1 m apart in each direction. The excavated earth is formed into a small ridge downslope of the pit. Manure is added to each pit, but its availability is sometimes a problem. At the start of the rainy season, millet or sorghum is sown in these pits.

The overall aim of the system is to capture and hold rainfall and runoff, and thereby improve water infiltration, while increasing nutrient availability. Stone lines are small structures, at most three stones wide and sometimes only one stone high. The distance between the lines is a function of the slope and availability of stone. Typically they are sited 25-50 m apart on 2-5% slopes. Stones are usually collected from nearby sites - though sometimes up to 5-10 km away and brought to the fields by donkey carts or lorries (when a project is involved). They are positioned manually, along the contour. Stone lines are intended to slow down runoff. They thereby increase the rate of infiltration, while simultaneously protecting the planting pits from sedimentation. Often grass establishes between the stones, which helps increase infiltration further and accelerates the accumulation of fertile sediment. Wind-blown particles may also build up along the stone lines due to a local reduction in wind velocity. The accumulation of sediment along the stone lines in turn favours water infiltration on the upslope side. This then improves plant growth, which further enhances the effect of the system. Construction does not require heavy machinery (unless the stones need to be brought from afar by lorry).

The technique is therefore favourable to spontaneous adoption. Stone lines may need to be repaired annually, especially if heavy rains have occurred. Manure is placed every second (or third) year into the previously dug pits and sand is removed annually: normally the highest plant production is during the second year after manure application.

**Above left:** Adding manure to the pits (*tassa*) before planting. (Photo: William Critchley)  
**Above right:** Stone lines in combination with *tassa*: the two measures act together to capture runoff and improve plant performance. (Photo: Charles Bielders)

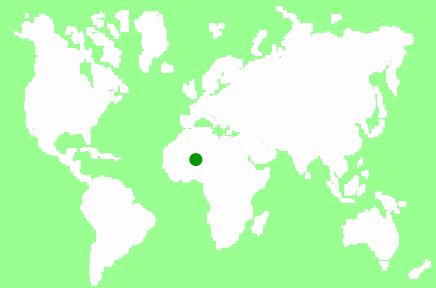

**Location / Region:** Tahoua district

**Technology area:** 40 km<sup>2</sup>

**Conservation measure:** structural

**Stage of intervention:** rehabilitation / reclamation of denuded land

**Origin:** developed externally / introduced through project, < 10 years ago

**Land use:** mixed (silvo-pastoralism) and cropland

**Climate:** semi-arid, tropics

**WOCAT database reference:** QT NIG002en on [cdewocat.unibe.ch/wocatQT](http://cdewocat.unibe.ch/wocatQT)

**Related approach:** Participatory land rehabilitation (QA NIG001en)













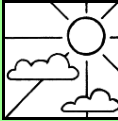



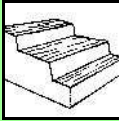
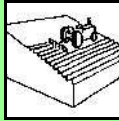

**Compiled by:** Oudou Noufou Adamou, Projet de développement rural de Tahoua, PDRT

**Date:** 01st Aug 1999, updated June 2004







## Classification

**Land use problems:** Soil fertility decline is the basic problem: this is due to degradation and nutrient mining. Loss of limited rainwater by runoff and loss of soil cover result in low crop production and food insufficiency. This occurs in combination with lack of pasture, resulting in shortage of manure.

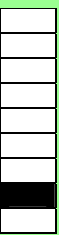
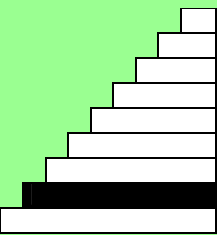
<b>Land use</b>  silvo-pastoralism (before)	 annual cropping (rainfed) (after)	<b>Climate</b>  semi-arid, tropics	<b>Degradation</b>  soil erosion by water: loss of topsoil/ surface erosion		 soil erosion by wind: loss of topsoil/ surface erosion	 chemical soil deterioration: fertility decline and reduced organic matter	 physical soil deterioration: compaction, sealing and crusting	<b>Conservation measure</b>  structural: stone lines, planting pits		 agronomic: manure application (supplementary)
<b>Stage of intervention</b>  Prevention  Mitigation / Reduction  Rehabilitation		<b>Origin</b>  Land user's initiative  Experiments / research  Externally introduced: < 10 years ago					<b>Level of technical knowledge</b>  Agricultural advisor  Land user			
<b>Main causes of land degradation:</b> Direct causes - natural: droughts Indirect causes: land tenure, poverty						<b>Main technical functions:</b> - increase in organic matter - increase of infiltration - increase / maintain water stored in soil - water harvesting / increase water supply - increase in soil fertility - increases natural regeneration of trees		<b>Secondary technical functions:</b> - reduction of slope length - improvement of ground cover - improvement of soil structure		 high  moderate  low  insignificant

## Environment

<b>Natural Environment</b>			
<b>Average annual rainfall (mm)</b>  > 4000 3000-4000 2000-3000 1500-2000 1000-1500 750-1000 500-750 250-500 < 250	<b>Altitude (m a.s.l.)</b>  > 4000 3000-4000 2500-3000 2000-2500 1500-2000 1000-1500 500-1000 100-500 <100	<b>Landform</b>  plateau / plains ridges mountain slopes hill slopes footslopes valley floors	<b>Slope (%)</b>  flat gentle moderate rolling hilly steep very steep
<b>Soil depth (cm)</b>  0-20 20-50 50-80 80-120 >120	<b>Growing season(s):</b> 90 days (June until September) <b>Soil texture:</b> coarse / light (sandy) <b>Soil fertility:</b> low <b>Topsoil organic matter:</b> low (<1%) <b>Soil drainage/infiltration:</b> good, though infiltration is low where there is a crust		<b>Soil water storage capacity:</b> low <b>Ground water table:</b> no data <b>Availability of surface water:</b> no data <b>Water quality:</b> no data <b>Biodiversity:</b> no data
<b>Tolerant of climatic extremes:</b> no data <b>Sensitive to climatic extremes:</b> no data <b>If sensitive, what modifications were made / are possible:</b> no data			

## Human Environment

### Cropland per household (ha)

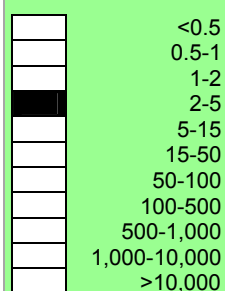

**Land user:** no data  
**Population density:** 10-50 persons/km<sup>2</sup>  
**Annual population growth:** 2-3%  
**Land ownership:** individual, titled  
**Land use rights:** individual  
**Water use rights:** no data  
**Relative level of wealth:** average, which represents 20% of the land users; 30% of the total area is owned by average land users

**Importance of off-farm income:** > 50% of all income: remittances from out-migration of labour, commerce and crafts  
**Access to service and infrastructure:** no data  
**Market orientation:** subsistence (self-supply)  
**Mechanization:** manual labour  
**Livestock grazing on cropland:** no data

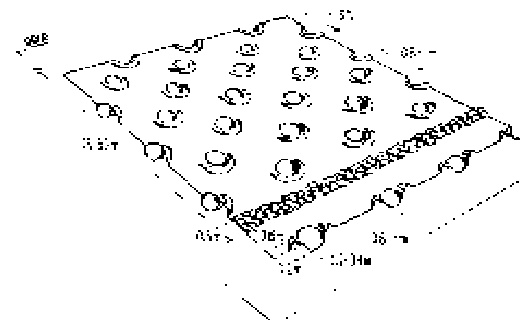

### Technical drawing

Planting pits (*tassa*) capture rainfall runoff for cultivation of annual crops, and the stone lines - spaced at 25-50 metres apart - help hold back moisture and eroded soil. (Mats Gurtner)

## Implementation activities, inputs and costs

### Establishment activities

1. Digging pits (*tassa*) with a hoe in the dry season: the excavated earth forms ridges downslope of the hole. The pits are spaced about 1m apart, giving approximately 10, pits/ha
2. Digging out stones from nearby sites
3. Transporting stones with donkey cart or lorries
4. Aligning the stones along the contour with the help of a 'water tub level': maximum of 3 stones wide
5. Manuring the pits with approximately 250 g per pit (2.5 t/ha)

### Establishment inputs and costs per ha

Inputs	Costs (US\$)	% met by land user
Labour		
- for digging <i>tassa</i> (100 person days)	150	100
- stone lines (25 person days)	40	100
Equipment		
- transporting stones with lorries	40	0
- tools for <i>tassa</i>	5	100
- tools for stone lines	5	75
Construction material		
- stone (50 m <sup>2</sup> )	0	
Agricultural		
- compost/manure (2.5 t)	5	100
<b>TOTAL</b>	<b>245</b>	<b>83</b>

### Maintenance/recurrent activities

1. Removing sand from the *tassa* (annually March - May)
2. Manuring the pits with about 250g per pit (2.5 t/ha) every second year in October/November or March-May
3. Check and repair stone lines annually and after heavy rains

### Maintenance/recurrent inputs and costs per ha per year

Inputs	Costs (US\$)	% met by land user
Labour		
- <i>tassa</i> (20 person days)	30	100
- stone lines (1 person days)	1.5	100
Equipment		
- tools for <i>tassa</i>	1	100
Agricultural		
- compost/manure (1.25 t)	2.5	100
<b>TOTAL</b>	<b>35</b>	<b>100</b>

**Remarks:** The costs are based on 300 m of stone lines per hectare (on a 3-4% slope). Maintenance costs refer to removing sand from the pits from the second year onwards, and to the application of manure every second year (costs are spread on an annual basis). If applicable, costs for transporting the manure need to be added. The general assumption in these calculations is that adequate manure is readily available close by. The availability of stones is the main factor in determining costs - though labour availability can affect prices also. If stones are not available in the field or nearby (from where they can be transported by donkey cart), they have to be carried by lorries, which is much more expensive. The costs here refer to fuel costs only, paid by a project: they do not include depreciation of lorries.

## Assessment

### Impacts of the Technology

#### Production and socio-economic benefits

- +++ increased crop yield
- ++ increased farm income

#### Production and socio-economic disadvantages

- ++ increased labour constraints
- ++ increased input constraints

#### Socio-cultural benefits

- ++ improved conservation / erosion knowledge
- + community / institution strengthening

#### Socio-cultural disadvantages

- + land use rights conflicts of rehabilitated land
- + conflicts between farmers and pastoralists

#### Ecological benefits

- ++ increased soil moisture
- ++ increased soil organic matter / below ground C
- ++ reduced soil loss
- ++ long-term soil cover improvement
- ++ increase in soil fertility

#### Ecological disadvantages

- + waterlogging in planting pits after heavy rains

#### Off-site benefits

- + reduced downstream flooding
- + reduced downstream siltation

#### Off-site disadvantages

none

#### Contribution to human well-being/livelihoods

no data

+++ : high, ++ : medium, + : low

#### Benefits/costs according to land user

##### Benefits compared with costs

##### short-term:

##### long-term:

##### Establishment

positive

very positive

##### Maintenance/recurrent

positive

very positive

**Acceptance/adoption:** 100% of land user families have implemented the technology with external material support. There is moderate growing spontaneous adoption (for rehabilitation of the plains), but there are no estimates available regarding the extent.

## Concluding statements

### Strengths and → how to sustain/improve

Simple technology, individually applicable in the dry season, requiring only very little training/knowledge and no special equipment.

Making best use of manure, which is a limiting resource.

Increase in agricultural production.

Rehabilitation of degraded and denuded land: bringing back into production formerly uncultivated land; extension of farm land to the plateaus.

### Weaknesses and → how to overcome

Labour demanding technology for implementation and maintenance → mechanisation of tasks: transportation of stones and manure. However, this would raise the cost.

Instability of planting pits in loose soil, increased erosion on steeper slopes and with heavier rains → avoid loose sandy soils and steep slopes.

The effectiveness can be compromised if the various geomorphological units (plateaus, slopes) are not treated simultaneously → catchment area approach if downstream flooding is an issue.

Possibility of land use conflicts concerning rehabilitated land, in particular with pastoralists → better coordination/consultation before implementing the technology in an area.

Implementation constraint: availability of manure and/or stones and transporting manure/stones to the plateaus and slopes → subsidised transport means (or supply donkey carts) or/and apply stone lines only in areas where there are stones available close to the fields.

**Key reference(s):** Bety A, Boubacar A, Frölich W, Garba A, Kriegl M, Mabrouk A, Noufou O, Thienel M and Wincker H: Gestion durable des ressources naturelles. Leçons tirées du savoir des paysans de l'Adar. Ministère de l'agriculture et de l'élevage, Niamey, 142 pp.. 199 / Hassane A, Martin P and Reij C: Water harvesting, land rehabilitation and household food security in Niger: IFAD's Soil and Water Conservation Project in Illela District. IFAD, Rome, 51 pp.. 2000.

**Contact person(s):** Oudou Noufou Adamou, Projet de développement rural de Tahoua (PDRT) BP 139 TAHOUA / fax: 61 02 31 / Tel: 61 05 24. pdrt@intnet.ne / Charles Bielder Dept. of Environ. Sciences and Land Use Planning – Agric. Engineering Unit, The Faculty of Bio-engineering, Agronomy and Environment, bielder@geru.ucl.ac.be / Eric Tielkesm Centre for Agriculture in the Tropics and Subtropics, University of Hohenheim, 70593 Stuttgart, Germany, tielkes@uni-hohenheim.de



## Furrow-enhanced runoff harvesting for olives

Syrian Arab Republic - إستغلال أنثام الفلاحة لحصاد المياه في بساتين الزيتون (Arabic)

**Runoff harvesting through annually constructed V-shaped microcatchments, enhanced by downslope ploughing.**

The Khanasser Valley in north-west Syria is a marginal agricultural area, with annual rainfall of about 220 mm/year. Soils are shallow and poor in productivity. The footslopes of degraded hills are traditionally used for extensive grazing or barley cultivation. However to achieve self-sufficiency in olive oil production, several farmers have developed orchards in this area - which is generally considered too dry for olives. Trees are spaced at 8 m apart, within and between rows. Traditionally, farmers prefer to till their orchards by tractor in order to keep them weed-free (weeds may attract sheep, lead to fires and compete for water with the olive trees). As this tillage operation is usually practised up and down the slope, the resulting furrows stimulate runoff and erosion. However, when this is combined with V-shaped and/or fish-bone shaped microcatchments around individual trees, the furrows created can be used to harvest runoff water for improved production. The V-shape earthen bunds (reinforced with some stones) are constructed manually, by hoe, around each tree. The furrows then divert runoff systematically to the microcatchments where it concentrates in basins around the trees. Each tree is effectively served by a catchment area of 60 m<sup>2</sup>. The catchment: cultivated area ratio is thus approximately 60:1 (assuming the area exploited by the tree). This technology saves irrigation water during the dry season, enhances soil moisture storage, and stimulates olive tree growth. Furthermore, fine particles of eroded soil are captured in the microcatchments. While these may be nutrient rich, they also tend to seal the surface.

The bunds need to be rebuilt every year. If the structures are damaged after a heavy storm, they need to be repaired. Labour input for establishment and maintenance is low, the technology is easy and cheap to maintain, and there is enough local skill to sustain and expand the system. A supporting technology is to mulch the area around each tree with locally available stones (limestone and/or basalt) to reduce soil temperature during the summer, decrease surface evaporation and improve infiltration. The catchment areas between the trees are sometimes planted with low water-demanding winter annuals (lentils, vetch, barley, etc.) especially when the trees are young. This helps to reduce surface erosion. Implementation of furrow-enhanced runoff water harvesting in olive orchards started in 2002, and adoption by farmers is growing gradually.

**Above left:** Runoff harvesting for olive trees by up-and-down tillage (by tractor) and V-shaped microcatchments (dug by hoe). (Photo: Francis Turkelboom)

**Above right:** Runoff is collected in micro-basins around each tree. Stone mulching - as a supportive measure - further enhances moisture conservation by reducing evaporation. (Photo: Francis Turkelboom)

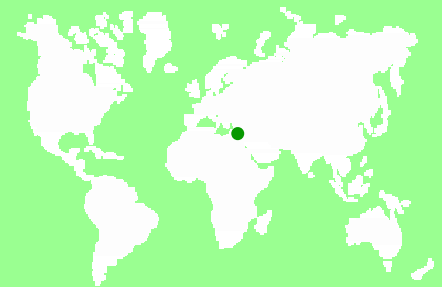

**Location:** Harbakiyeh and Habs, Khanasser Valley

**Region:** Aleppo, Northwest Syria

**Technology area:** 0.05 km<sup>2</sup>

**Conservation measure:** agronomic and structural

**Stage of intervention:** rehabilitation / reclamation of denuded land

**Origin:** Developed externally / introduced through project

**Land use:** cropland and mixed (silvopastoralism)

**Climate:** semi-arid, temperate

**WOCAT database reference:** QT SYR003en on [cdewocat.unibe.ch/wocatQT](http://cdewocat.unibe.ch/wocatQT)

**Related approach:** Participatory technology development (QA SYR03)

**Compiled by:** Francis Turkelboom, ICARDA

**Date:** 01st Nov 2004, updated April 2005



## Classification

**Land use problems:** There are a series of problems in this area, including: low and erratic rainfall, drought, low land productivity, poor water use efficiency, land degradation, limited ground water for irrigation, few agricultural options, and low income from agriculture.

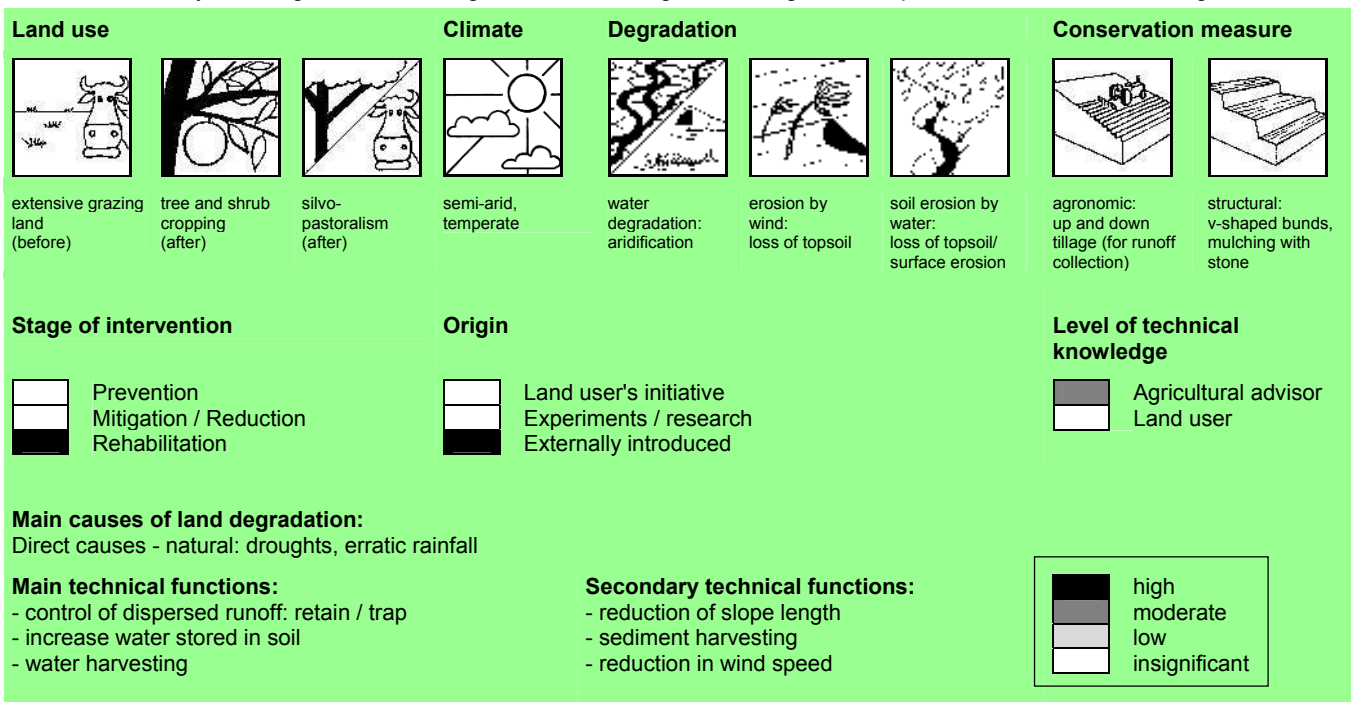

## Environment

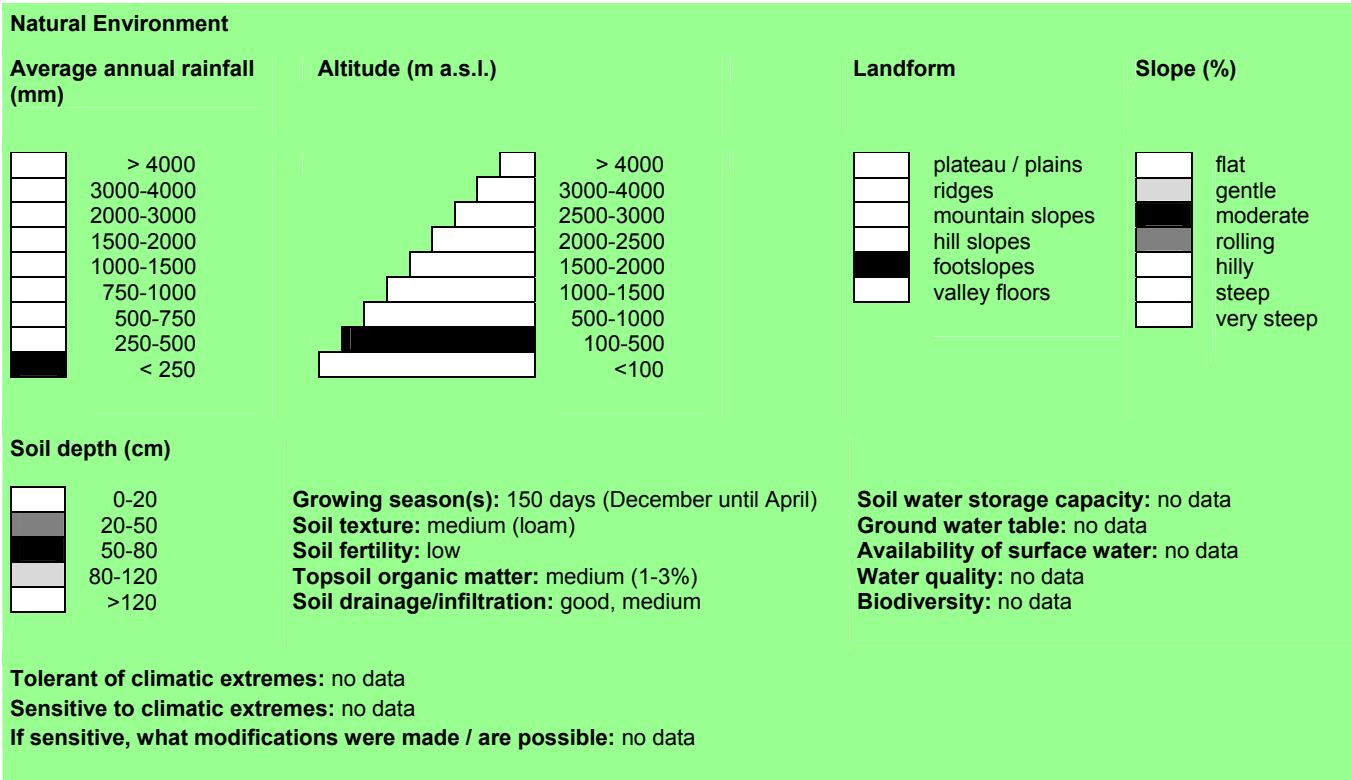

## Human Environment

### Cropland per household (ha)

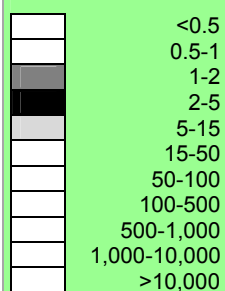

**Land user:** individual  
**Population density:** no data  
**Annual population growth:** 1 - 2%  
**Land ownership:** individual, titled  
**Land use rights:** individual  
**Water use rights:** no data  
**Relative level of wealth:** no data

**Importance of off-farm income:** 10 - 50% of all income: from farm labour and non-agricultural activities in nearby cities  
**Access to service and infrastructure:** no data  
**Market orientation:** mixed (subsistence and commercial)  
**Mechanization:** no data  
**Livestock grazing on crop residues:** yes

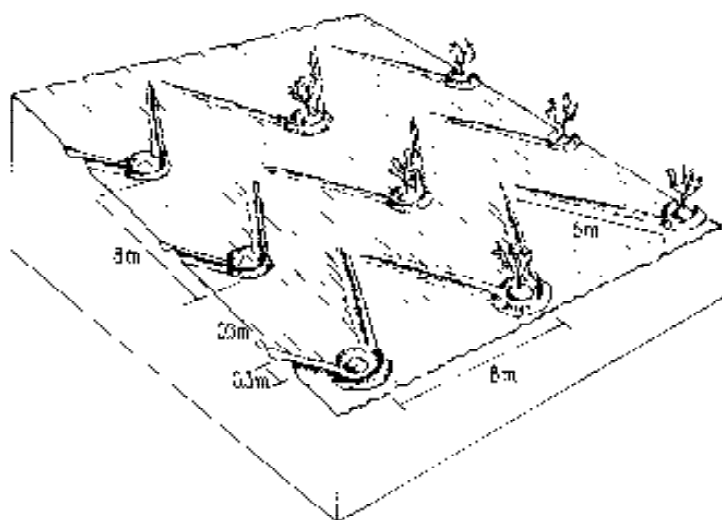

### Technical drawing

V-shaped micro-catchments which harvest water for the olive trees: the furrows up-and-down slope help channel the runoff to the olives. (Mats Gartner)

## Implementation activities, inputs and costs

### Establishment activities

- Up-and-down tillage by tractor driven plough; in winter
- Construction of runoff harvesting bunds and micro-basins, manually by hoe (November/December; beginning of rainy season).

V-shaped bunds are seasonal structures and thus established every year. Construction of runoff harvesting bunds and micro-basins

### Establishment inputs and costs per ha

Inputs	Costs (US\$)	% met by land user
Labour		
- construction (10 person days)	50	100
- repair (5 person days)	25	100
Equipment		
- machine use	10	100
- tools	3	100
Construction material		
- earth (in-situ available)	0	
<b>TOTAL</b>	<b>88</b>	<b>100</b>

### Maintenance/recurrent activities

- Maintenance of bunds in winter/rainy season, after heavy rainfall 1-3 times a year

### Maintenance/recurrent inputs and costs per ha per year

Inputs	Costs (US\$)	% met by land user
no data		

**Remarks:** The calculation covers the runoff harvesting technology alone - annual activities of ploughing and water harvesting structure establishment and maintenance. Planting of olive trees and their maintenance are not included here.

## Assessment

Impacts of the Technology	
<b>Production and socio-economic benefits</b> ++ water saving ++ better tree growth + increased crop yield	<b>Production and socio-economic disadvantages</b> ++ depends on availability of tractor + increased labour constraints + hindered farm operations + increased weed growth around trees
<b>Socio-cultural benefits</b> ++ improved conservation / erosion knowledge + improved landscape and environmental quality	<b>Socio-cultural disadvantages</b> none
<b>Ecological benefits</b> +++ reduced surface runoff +++ reduced soil loss ++ increased soil moisture + reduced wind velocity + increase in soil fertility + biodiversity enhancement	<b>Ecological disadvantages</b> none
<b>Off-site benefits</b> + reduced downstream flooding + reduced downstream siltation	<b>Off-site disadvantages</b> + reduced runoff for infiltration in valley bottom + reduced sediment yields in valley bottom
<b>Contribution to human well-being/livelihoods</b> no data	

+++ : high, ++ : medium, + : low

Benefits/costs according to land user	Benefits compared with costs	
	short-term:	long-term:
Establishment	n/ap*	n/ap
Maintenance/recurrent	n/ap	n/ap

n/ap\* not applicable

**Acceptance/adoption:** 100% of land user families have implemented the technology voluntary. There is little trend towards (growing) spontaneous adoption of the technology. Mainly applied by 'agriculturalists' that is households whose livelihoods mainly depend on agriculture. Farmers with more interest in off-farm labour or sheep rearing - less interested. Is expanding slowly but gradually.

## Concluding statements

Strengths and → how to sustain/improve	Weaknesses and → how to overcome
Increases soil moisture storage in low rainfall areas and allows expansion of olive plantation into drier areas → use organic amendments (mulch or manure), and more stone mulching.	Extra labour needed → construct during off-season.
Easy, low-cost and requires no extra external inputs.	Increases weed growth in the tree basin → more stone mulching.
Reduces soil erosion.	Trees will still need some irrigation in summer → make irrigation practices more efficient.
Reduces summer irrigation needs → use of localised (drip) irrigation will further reduce overall irrigation needs.	
Improves olive productivity → rip land prior to planting to achieve further gains.	

**Key reference(s):** Tubeileh A. and Turkelboom F. (2004) Participatory research on water and soil management with olive growers in the Khanasser Valley. KVIRS project, ICARDA, Syria. / Tubeileh A., Bruggeman A., Turkelboom F. (2004) Growing olive and other tree species in marginal dry environments, ICARDA, Aleppo, Syria.

**Contact person(s):** Francis Turkelboom, F.Turkelboom@cigar.org / Ashraf Tubeileh, A.Tubeileh@cigar.org / Adriana Bruggeman, A.Bruggeman@cigar.org. All from ICARDA, Aleppo, Syria, www.icarda.org



## Vallerani system

Burkina Faso

**A special tractor-pulled plough that automatically constructs water-harvesting catchments, ideally suited for large-scale reclamation work.**

The Vallerani implement is a modified plough named Delfino3, pulled by a heavy-duty tractor. A normal plough on flat land excavates a symmetrical furrow, and earth piles up equally on both sides of the furrow. The Delfino3 plough has a single reversible ploughshare that creates an angled furrow and piles up the excavated soil only on the lower (downhill) side. This soil forms a ridge that stops or slows down runoff water as it flows downhill. The plough's blade moves up and down (i.e. in and out of the soil), creating micro basins about 5 meters long, 50 cm deep and spaced about 2 m, each with a ridge. Two rippers placed before the plough work the soil to a depth of 70 cm, rise at the basin and descend between the basins. Thus to attain, in the stretch of land between the crescent, a collection bag which receives water from the crescents itself. Even with very low rainfall (150-500 mm/year) each micro-basin/storage bag can collect 1,500 litres of water, including runoff. This water is protected against evaporation and remains available to plant roots and groundwater.

The Vallerani System (VS) is based on direct sowing of seeds of shrubs and trees of locally available, indigenous species. They are sown along the ridges of the basins and in the wake of the ripper. In the case study area *Acacia tortilis*, *Ziziphus mauritania*, *Balanites aegyptiaca*, *Acacia senegal*, *Acacia seyal* and *Faidherbia albida* have been sown. While for most species seeds can be collected by the local population, for species rarely present in the region, the seeds have to be purchased from tree nurseries. The use of goat excrements containing seeds has also proven successful (about 95% of all micro basin have at least one tree growing after 3 years) when directly sown. With more moisture available for a long time trees grow rapidly and the herbaceous cover improves in quality and in quantity - providing 20-30 times more livestock fodder (1,000-2,000kg dry herbaceous biomass ha/year), also helping to conserve the soil. The ploughed and sown area is not protected by fences, grazing of animals shall be allowed so that villagers can benefit from the forage and reduce the accumulation of biomass fuel that would further the risk of fires in the dry season.

The Vallerani plough can 'treat' up to 20 ha, digging 5,720 micro basins, in a single day. The speed and effectiveness of the Delfino3 plough are its major advantages in the fight against desertification, but can also be its major limitation as to be able to make the best of it, it is necessary to find great availability of land to be reforested or cultivate. This is mainly possible related to a large public or business initiative. The spreading "like wildfire" that has characterized the case study was made possible by the presence on the territory of an NGO already active and rooted in the territory for many years and by perseverance, respect and competence of partner "of the North". Once the project has invested in the tractor and the plough (tractor ~ 70,000 EUR, plough ~ 40,000 EUR), the remaining cost of implementation – labour costs for local workers and drivers, fuel etc. amount to around EUR 125 / ha / year.

The case study area in the north east of Burkina Faso receives about 300-500 mm of annual rainfall. The soils of this agro-pastoral land are heavily degraded with a low tree density and an almost entirely absent herbaceous cover.

**Above left:** The Delfino3 plough at work. The picture shows the moment in which, after digging a micro basin, the ploughshare is coming out of the soil while the 2 rippers are going deeper in creating the underground water bag. (Photo: Deserto Verde)

**Above right:** Local people sowing indigenous tree seeds in the processing furrow and the same land 3 years after plowing. (Photo: Deserto Verde)

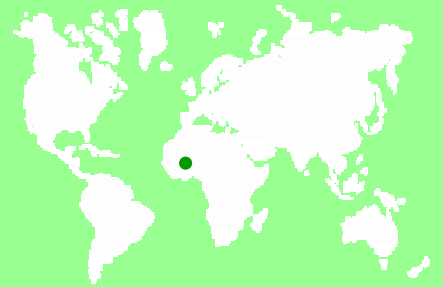

**Location:** Oudalan

**Region:** Gorom-Gorom

**Technology area:** 50 km<sup>2</sup>

**Conservation measure:** structural, vegetative,

**Stage of intervention:** rehabilitation / reclamation of denuded land

**Origin:** introduced through land users initiative, traditional, > 50 years ago

**Land use:** mixed (agro-silvopastoralism)

**Climate:** arid, subtropics

**WOCAT database reference:** QT BRK011en on [cdewocat.unibe.ch/wocatQT](http://cdewocat.unibe.ch/wocatQT)

**Related approach:** not documented

**Compiled by:** Sabina Vallerani, Associazione Deserto Verde, Burkina Faso

**Date:** 03rd May 2012













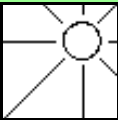

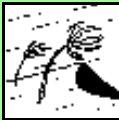

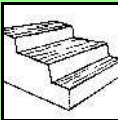

**Vallerani System**



## Classification

**Land use problems:** Land degradation-desertification with reduction of vegetation cover in terms of plant density and species diversity is the main problem: disappearance of grasses and trees, reduction of the size of the plants that are resistant and of the biological activity of the soil. Runoff, water and wind erosion increase. Drought and irregular precipitation have heavy consequences on soil fertility, availability of water for humans and livestock, and recharging groundwater.

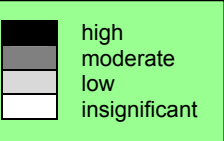
Land use		Climate	Degradation		Conservation measure		
							
agro-silvopastoralism	extensive grazing land (rainfed)	arid, subtropics	soil erosion by water: loss of topsoil/ surface erosion, gully erosion	soil erosion by wind: loss of topsoil	biological degradation: reduction of vegetation cover, quality and species composition/ diversity decline	structural: level ditches / pits	vegetative: tree and shrub cover, grasses and perennial herbaceous plants
<b>Stage of intervention</b>		<b>Origin</b>		<b>Level of technical knowledge</b>			
 Prevention  Mitigation / Reduction  Rehabilitation		 Land user's initiative: > 50 years ago  Experiments / research  Externally introduced		 Agricultural advisor  Land user			
<b>Main causes of land degradation:</b>							
Direct causes - human induced: over-exploitation of vegetation for domestic use, overgrazing							
Direct causes - natural: change of seasonal rainfall, droughts							
<b>Main technical functions:</b>		<b>Secondary technical functions:</b>					
<ul style="list-style-type: none"> <li>- control of raindrop splash</li> <li>- improvement of ground cover</li> <li>- improvement of topsoil structure (compaction)</li> <li>- stabilisation of soil (e.g. by tree roots against landslides)</li> <li>- water harvesting / increase water supply</li> <li>- increase of biomass (quantity)</li> <li>- promotion of vegetation species and varieties (quality, e.g. palatable fodder)</li> </ul>		<ul style="list-style-type: none"> <li>- increase in organic matter</li> <li>- increase in nutrient availability (supply, recycling,...)</li> <li>- increase of infiltration</li> <li>- increase / maintain water stored in soil</li> </ul>					

## Environment

### Natural Environment

#### Average annual rainfall (mm)

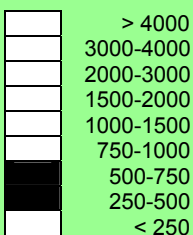

#### Altitude (m a.s.l.)

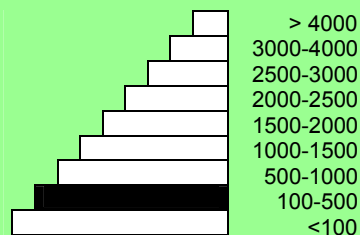

#### Landform

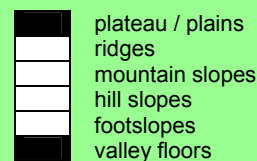

#### Slope (%)



#### Soil depth (cm)

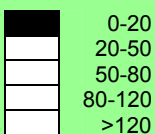

**Growing season(s):** 90 days  
**Soil texture:** coarse / light (sandy)  
**Soil fertility:** low  
**Topsoil organic matter:** low (<1%)  
**Soil drainage/infiltration:** poor (e.g. sealing /crusting)

**Soil water storage capacity:** low  
**Ground water table:** no data  
**Availability of surface water:** good, poor / none  
**Water quality:** for agricultural use only  
**Biodiversity:** low

**Tolerant of climatic extremes:** temperature increase, seasonal rainfall increase, seasonal rainfall decrease, heavy rainfall events (intensities and amount), wind storms / dust storms, droughts / dry spells, decreasing length of growing period

**Sensitive to climatic extremes:** no data

**If sensitive, what modifications were made / are possible:** no data

## Human Environment

### Land per household (ha):

no data

	<0.5
	0.5-1
	1-2
	2-5
	5-15
	15-50
	50-100
	100-500
	500-1,000
	1,000-10,000
	>10,000

**Land user:** groups / community, small scale land users, common / average land users, men and women

**Population density:** 10-50 persons/km<sup>2</sup>

**Annual population growth:** 3 - 4%

**Land ownership:** state

**Land use rights:** open access (unorganized)

**Water use rights:** open access (unorganized)

**Relative level of wealth:** no data

**Importance of off-farm income:** less than 10% of all income: The only activity people of the region are engaged in is goat and cattle breeding. Crop production is practiced only for subsistence use.

**Access to service and infrastructure:** low: health, technical assistance, employment (e.g. off-farm), market, energy, roads & transport, drinking water and sanitation, financial services; moderate: education

**Market orientation:** mixed (subsistence and commercial)

**Mechanization:** mechanized

**Livestock grazing on crop residues:** little

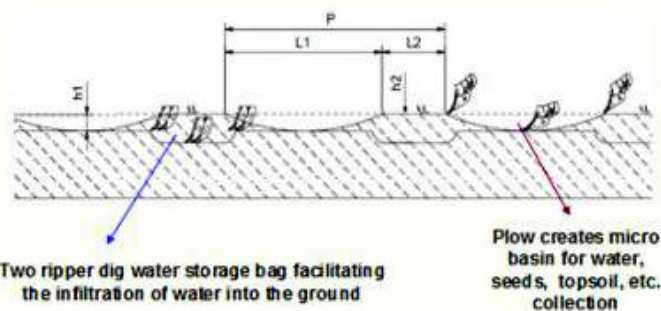
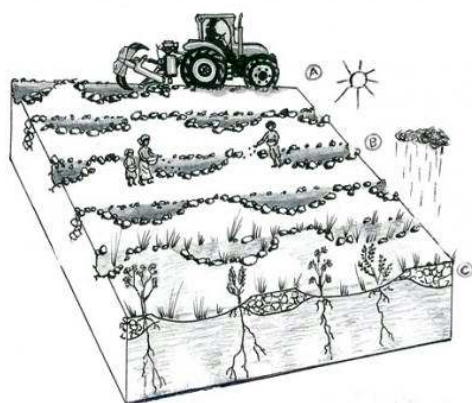

## Implementation activities, inputs and costs

### Establishment activities

1. Project planning, consulting and training by VS and national experts
2. Plowing with the Delfino special plough pulled by a 210hp tractor
3. Seed harvesting can be done by local people either collecting them directly from plants or by shaking the plants at the appropriate time, to feed the goats and sheep with the fallen seeds and collect their dung in the night enclosure
4. Missing seeds can be purchased in local markets or, if trees are too rare or if the species is no longer present, seeds must be purchased at a nursery
5. Direct sowing

### Establishment inputs and costs per ha

Inputs	Costs (US\$)	% met by land user
Labour	72	50
Equipment - machine use	23.4	0
<b>TOTAL</b>	<b>95.4</b>	<b>37.74</b>

### Maintenance/recurrent activities

No maintenance activities are required.

### Maintenance/recurrent inputs and costs per ha per year

**Remarks:** Upfront costs for the acquisition of the required materials are around 40,000 EUR for the plough and 70,000 EUR for the tractor. All data presented in the table refer to an ideal project which lasts 5 years with 3,000 hectares plowed each year. All works are carried for economic compensation. Item number 1 refers to the planning, training and consulting advisors that have a strong impact on the cost per ha (\$ 47). This value would remain the same if 3 MTU (Mechanized Technical Unit) as compared to 1MTU were used in the same area reducing the above cost to \$ 15.6 per ha.

## Assessment

Impacts of the Technology	
<b>Production and socio-economic benefits</b> +++ increased wood production ++ increased fodder production ++ increased fodder quality	<b>Production and socio-economic disadvantages</b> none
<b>Socio-cultural benefits</b> +++ community institution strengthening +++ national institution strengthening +++ conflict mitigation +++ improved conservation / erosion knowledge +++ improved situation of disadvantaged groups +++ improved food security / self sufficiency +++ improved health +++ training of skilled labour in disadvantaged regions ++ improved cultural opportunities	<b>Socio-cultural disadvantages</b> none
<b>Ecological benefits</b> +++ improved harvesting / collection of water +++ increased soil moisture +++ reduced surface runoff +++ increased biomass above ground C +++ reduced soil loss +++ reduced soil compaction ++ recharge of groundwater table / aquifer ++ increased nutrient cycling recharge ++ increased soil organic matter / below ground C	<b>Ecological disadvantages</b> ++ increased fire risk + increased threat from wild animals
<b>Off-site benefits</b> + reduced downstream flooding + reduced damage on public / private infrastructure	<b>Off-site disadvantages</b> none
<b>Contribution to human well-being/livelihoods</b> +++ Thanks to the enormous increase of trees, pasture and crop production, the quality of life and health have improved considerably	

+++ : high, ++ : medium, + : low

Benefits/costs according to land user	Benefits compared with costs	short-term:	long-term:
	Establishment	very negative	very positive
	Maintenance/recurrent	negative	very positive

Implementation of the technology is relatively expensive. Once installed, maintenance is not expensive and pays off because of higher productivity.

**Acceptance/adoption:** 100% of land user families have implemented the technology with external material support. The system includes the use of a heavy duty tractor and a special plough whose costs are high though difficult to sustain by the local population. All correlated activities are done (or can be done) without external material support. There is strong trend towards (growing) spontaneous adoption of the technology.

## Concluding statements

### Strengths and → how to sustain/improve

This practice allows for the rapid and efficient treatment of large degraded areas within a short time → good maintenance of machinery.

The tree and shrub species planted are mainly indigenous and locally adapted species → reintroduction of indigenous plants that have disappeared in last decades to improve biodiversity and resilience.

Through its tillage process the Vallerani system offers the highest degree of efficiency in the first years from processing. Its effects last for a long time so it does not need to be repeated on the same site → sensitize the local population to a sustainable use of the products of the processed soil.

The VS does not use any water (except rain) in countries where water is rare and precious. It further avoids the risk of soil salinisation → converge the funds allocated to the nurseries to spread the Vallerani system, the nurseries workers can do the activities necessary to the explication of the Vallerani system: collecting seeds, sowing, village animators, tractor drivers, etc.

### Weaknesses and → how to overcome

The investment costs for the machinery are extremely high and cannot be covered by single land users or even communities → projects must be financed externally.

The speed and effectiveness of the Delfino3 plow are its major advantages in the fight against desertification, but can also be its major limitation as to be able to make the best of it, it is necessary to find great availability of land to be reforested or cultivate → this is mainly possible related to a large public or business initiative.

Since great extensions will be processed, a big organisation is needed for all activities (awareness raising, collecting seeds, personnel training, logistics, etc.) → this must be well organized and should operate already before starting plowing.

**Key reference(s):** Conedera, M., N. Bomio-Pacciorini, et al. 2010. Reconstitution des écosystèmes dégradés sahéliens. Bois et Forêts des Tropiques 304(2). (<http://www.vallerani.com/images/Reconstitution.pdf>) / Akhtar Ali, Theib Oweis, Atef Abdul Aal, Mohamed Mudabbar, Khaled Zubaidi, and Adriana Bruggeman. 2006. The Vallerani Water Harvesting System. ICARDA Caravan No. 23. (<http://www.vallerani.com/images/Caravan-23.pdf>)  
**Contact person(s):** Sabina Vallerani, Deserto Verde Burkinabé, 6763 Mairengo, Switzerland. [valleranisystem@gmail.com](mailto:valleranisystem@gmail.com)





## Fanya juu terraces

Kenya - *Fanya Juu* (Kiswahili)

**Terrace bund in association with a ditch, along the contour or on a gentle lateral gradient. Soil is thrown on the upper side of the ditch to form the bund, which is often stabilised by planting a fodder grass.**

Fanya juu ('throw it upwards' in Kiswahili) terraces comprise embankments (bunds), which are constructed by digging ditches and heaping the soil on the upper sides to form the bunds. A small ledge or 'berm' is left between the ditch and the bund to prevent soil sliding back. In semi-arid areas, fanya juu terraces are normally constructed on the contour to hold rainfall where it falls, whereas in sub-humid zones they are laterally graded to discharge excess runoff. Spacing is according to slope and soil depth (see technical drawing). For example, on a 15% slope with a moderately deep soil, the spacing is 12 m between structures and the vertical interval around 1.7 m. The typical dimensions for the ditches are 0.6 m deep and 0.6 m wide. The bund has a height of 0.4 m and a base width of 0.5-1 m. Construction by hand takes around 90 days per hectare on a typical 15% slope, though labour rates increase considerably on steeper hillsides because of closer spacing of structures.

The purpose of the fanya juu is to prevent loss of soil and water, and thereby to improve conditions for plant growth. The bund created is usually stabilised with strips of grass, often napier (*Pennisetum purpureum*), or makarikari (*Panicum coloratum* var. *makarikariensis*) in the drier zones. These grasses serve a further purpose, namely as fodder for livestock. As a supportive and supplementary agroforestry measure, fruit or multipurpose trees may be planted immediately above the embankment (eg citrus or *Grevillea robusta*), or in the ditch below in drier areas (eg bananas or pawpaws), where runoff tends to concentrate. As a consequence of water and tillage erosion, sediment accumulates behind the bund, and in this way fanya juu terraces may eventually develop into slightly forward-sloping (or even level) bench terraces. Maintenance is important: the bunds need annual building-up from below, and the grass strips require trimming to keep them dense. Fanya juu terraces are associated with hand construction, and are well suited to small-scale farms where they have been used extensively in Kenya. They first came into prominence in the 1950s, but the period of rapid spread occurred during the 1970s and 1980s with the advent of the National Soil and Water Conservation Programme. Fanya juu terraces are spreading throughout Eastern African, and further afield also.

**Above left:** Fanya juu terraces in a semi-arid area which have developed over time into benches: note well established grass strips along the bunds. (Photo: Hanspeter Liniger)

**Above right:** Fanya juu bund in maize field after harvest: napier grass strip on upper part of bund, and maize trash in ditch below. (Photo: Hanspeter Liniger)

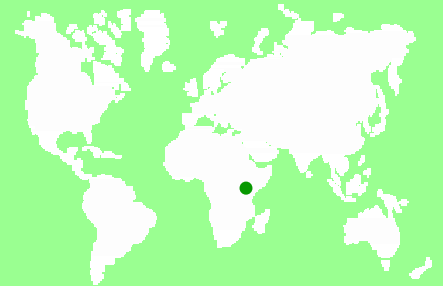

**Location / Region:** Eastern Province

**Technology area:** 3,000 km<sup>2</sup>

**Conservation measure:** structural

**Stage of intervention:** mitigation / reduction of land degradation

**Origin:** developed through land user's initiative, traditional, > 50 years ago

**Land use:** cropland

**Climate:** sub-humid to semi-arid, tropics

**WOCAT database reference:** QT KEN005en on [cdewocat.unibe.ch/wocatQT](http://cdewocat.unibe.ch/wocatQT)

**Related approach:** Catchment approach QA KEN01





**Compiled by:** Donald Thomas; Kithinji Mutunga and Joseph Mburu, Ministry of Agriculture, Kenya

**Date:** January 1999, updated June 2004



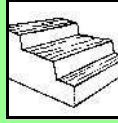
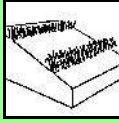
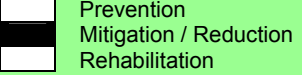
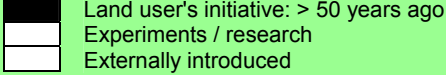
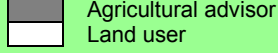
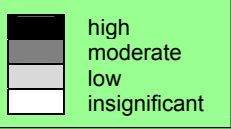

## Classification

**Land use problems:** Low and erratic rainfall. Soil erosion. Soil sealing. Water losses through runoff. Low fertility and land shortage. Low and erratic rainfall, soil erosion, surface sealing, water loss through runoff, low soil fertility as well as shortage of land and thus a need to conserve resources.

<p><b>Land use</b></p>  <p>annual cropping (rainfed)</p>	<p><b>Climate</b></p>   <p>semi-arid to sub-humid, tropics</p>	<p><b>Degradation</b></p>   <p>water degradation: aridification soil erosion by water: loss of topsoil</p>	<p><b>Conservation measure</b></p>   <p>structural: bunds vegetative: grass strips (supp.) aligned trees (opt.)</p>
<p><b>Stage of intervention</b></p> 	<p><b>Origin</b></p> 	<p><b>Level of technical knowledge</b></p> 	
<p><b>Main causes of land degradation:</b> Direct causes - human induced: over-exploitation of vegetation for domestic use, other human induced causes, agricultural causes</p> <p><b>Main technical functions:</b> - control of concentrated runoff: retain / trap - reduction of slope angle - reduction of slope length - increase of infiltration - increase / maintain water stored in soil</p> <p><b>Secondary technical functions:</b> none</p> 			

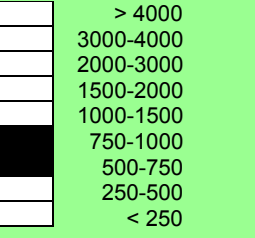
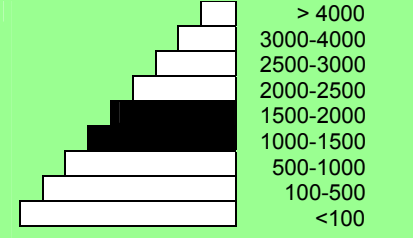
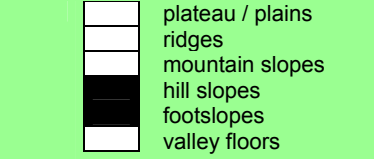
## Environment

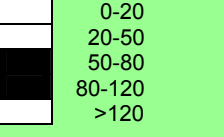
<p><b>Natural Environment</b></p>			
<p><b>Average annual rainfall (mm)</b></p> 	<p><b>Altitude (m a.s.l.)</b></p> 	<p><b>Landform</b></p> 	<p><b>Slope (%)</b></p> 
<p><b>Soil depth (cm)</b></p> 	<p><b>Growing season(s):</b> 180 days (March until August) <b>Soil fertility:</b> medium (loam) <b>Topsoil organic matter:</b> medium (1-3%) or low (&lt;1%) <b>Soil drainage/infiltration:</b> good or medium</p>		<p><b>Soil water storage capacity:</b> medium <b>Ground water table:</b> no data <b>Availability of surface water:</b> no data <b>Water quality:</b> no data <b>Biodiversity:</b> no data</p>
<p><b>Tolerant of climatic extremes:</b> no data <b>Sensitive to climatic extremes:</b> no data <b>If sensitive, what modifications were made / are possible:</b> no data</p>			

## Human Environment

### Cropland per household (ha)

	<0.5
	0.5-1
	1-2
	2-5
	5-15
	15-50
	50-100
	100-500
	500-1,000
	1,000-10,000
	>10,000

**Land user:** individual household, small scale land user

**Population density:** 100-200 persons/km<sup>2</sup>

**Annual population growth:** 2 - 3%

**Land ownership:** individual titled and individual not titled

**Land use rights:** individual

**Water use rights:** individual

**Relative level of wealth:** average, which represents 50% of land users; 60% of the total land area is owned by average land users

**Importance of off-farm income:** 10-50% of all income: from local employment, trade and remittances -this depends very much on the location: the nearer a large town, the greater the importance of off-farm income

**Access to service and infrastructure:** no data

**Market orientation:** subsistence (self-supply), mixed (subsistence and commercial)

**Mechanization:** mechanised animal traction

**Livestock grazing on cropland:** no data

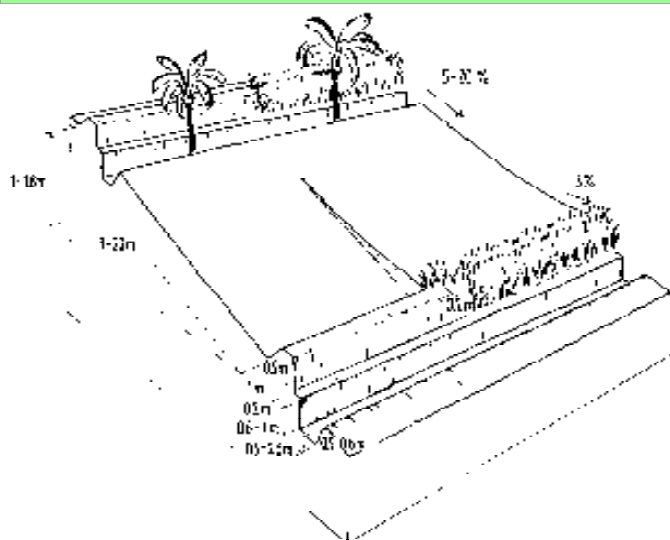

### Technical drawing

Technical drawing: Fanja juu terraces: newly constructed (left) and mature (right) with bananas planted below the bund and fodder grass on the riser: note levelling occurs over time (right). (Mats Gurtner)

## Implementation activities, inputs and costs

### Establishment activities

1. Layout (alignment and spacing) of terraces either on the contour (dry areas) or on a slight grade (more humid areas) often using simple farmer operated 'line levels'
2. Tilling soil to loosen for excavation
3. Digging ditch/trench and throwing the soil upwards to make the bund
4. Levelling and compacting bund.
5. Digging planting holes for grass.
6. Creating splits of planting materials (of propagated species)
7. Manuring (of napier grass and fruit trees)
8. Planting grasses.

### Establishment inputs and costs per ha

Inputs	Costs (US\$)	% met by land user
Labour (90 person days)	270	100
Equipment		
- animal traction (ox-drawn plough)	20	100
- tools (hoes, shovels, machete)		
Agricultural		
- compost/manure	10	100
- grass splits	20	100
<b>TOTAL</b>	<b>320</b>	<b>100</b>

### Maintenance/recurrent activities

1. Repairing breaches in structure where necessary
2. Building up bund annually
3. Cutting grass strips to keep low and non-competitive, and provide fodder for livestock
4. Maintaining grass strips weed-free and dense.
5. Manuring of napier grass.

### Maintenance/recurrent inputs and costs per ha per year

Inputs	Costs (US\$)	% met by land user
Labour	30	100
Equipment		
- tools (hoes, shovels, machete)	5	100
Agricultural		
- compost / manure (250 kg)	3	100
<b>TOTAL</b>	<b>38</b>	<b>100</b>

**Remarks:** These calculations are based on a 15% slope (with 830 running metres of terraces per hectare) with typical dimensions and spacing: according to table and drawing above. In some areas tools are supplied free - but this is normally just for demonstration plots and is not included in this calculation).



## Assessment

### Impacts of the Technology

#### Production and socio-economic benefits

- ++ increased crop yield
- ++ increased wood production
- ++ increased farm income
- ++ fodder production/quality increase

#### Production and socio-economic disadvantages

- ++ loss of land
- ++ increased labour constraints
- + increased input constraints
- + awkward to walk/carry burdens through the field

#### Socio-cultural benefits

- ++ community institution strengthening
- ++ improved conservation / erosion knowledge
- + national institution strengthening

#### Socio-cultural disadvantages

none

#### Ecological benefits

- ++ increased soil moisture
- ++ improved excess water drainage
- ++ reduced soil loss

#### Ecological disadvantages

none

#### Off-site benefits

- ++ reduced downstream siltation
- + reduced downstream flooding
- + increased stream flow in dry season

#### Off-site disadvantages

none

#### Contribution to human well-being/livelihoods

no data

+++ : high, ++ : medium, + : low

#### Benefits/costs according to land user

Benefits compared with costs	short-term:	long-term:
<b>Establishment</b>	slightly negative	positive
<b>Maintenance/recurrent</b>	positive	very positive

**Acceptance/adoption:** 30% of land user families (50000 families; 30% of area) have implemented the technology with external material support. Estimates 70% of land user families (100000 families; 70% of area) have implemented the technology voluntary. There is moderate trend towards (growing) spontaneous adoption of the technology. There is some growing spontaneous adoption outside the area due to recognition of the benefits by farmers. This is especially so through women's groups. Within the area specified, Machakos District, almost all cropland is terraced.

## Concluding statements

#### Strengths and → how to sustain/improve

Control runoff and soil loss → ensure good design, maintenance of structures and adapt design to local conditions.

Storage of water in soil for crops → ensure good design, maintenance of structures and adapt design to local conditions.

Maintenance of soil fertility → ensure good design, maintenance of structures and adapt design to local conditions.

Increased value of land → ensure good design, maintenance of structures and adapt design to local conditions.

#### Weaknesses and → how to overcome

Loss of cropping area for terrace bund → site-specific implementation: only where fanya juu terraces are absolutely needed, i.e. agronomic (e.g. mulching, contour ploughing) and vegetative measures are not sufficient in retaining/diverting runoff.

High amounts of labour involved for initial construction → spread labour over several years and work in groups.

Risk of breakages and therefore increased erosion → accurate layout and good compaction of bund.

Competition between fodder grass and crop → keep grass trimmed and harvest for livestock feed.

**Key reference(s):** Thomas D (1997) Soil and water conservation manual for Kenya. Soil and water conservation Branch. Nairobi

**Contact person(s):** Donald Thomas; Kithinji Mutunga and Joseph Mburu, Ministry of Agriculture, Kenya; Kithinji.Mutunga@fao.org

# ROOFTOP AND COURTYARD WATER HARVESTING



Water harvested from non-galvanized iron roof. (C. Studer)

## In a nutshell

### Short description

Roof and courtyard water harvesting (Rooftop-CourtyardWH) provides water close to home. Rainfall is collected as it runs off the catchment area of house roofs or compacted / paved surfaces in and around courtyards. The collected water is transported through a conveyance system of gutters and downpipes to storage facilities of various types. Roof materials suitable for water harvesting can be of many sorts, depending on technology, natural conditions and affordability. These include galvanised corrugated iron, aluminium or cement sheets, and tiles and slates. In many tropical countries thatch, bamboo or palm-leaved roofs can provide a low-cost alternative. However, they are difficult to clean and can taint runoff. Guttering, downpipes, filtration and storage facilities can be of a very simple type and made of locally available materials or specifically manufactured for the purpose. Clearly, the larger the roof the bigger the runoff yield: rainwater potentially collectable from a roof over one year can be estimated as the annual rainfall times the roof's plan area – but in the tropics only about 85% of this water runs off the roof. The remaining 15% is typically lost to evaporation and splashing. If the rain falls mainly as light drizzle, as in some more temperate countries, even more than 15% will be lost in this way through slow evaporation. Water quality can be protected by adding a filtration device or by "first flush" process. Rooftop-CourtyardWH is usually made use of by individual households, but also by communal / public institutions such as schools or hospitals, or commercial companies.

### Water storage and purpose

Closed storage systems can be above ground, below ground or a combination of these. Depending on size, shape or location they are called "tank", "jar", "drum" or "cistern". The collected water is used for drinking, domestic use and livestock consumption, as well as irrigation of small kitchen gardens and backyard crops, depending on the need and quality of water harvested.

### Most common technologies

Rooftop WH: Water harvested from corrugated galvanised iron, aluminium or cement sheets, tiled and slated or organic roofs and stored in underground or above ground storage facilities.

Courtyard WH: Water harvested from compacted/ paved surfaces and stored in underground storage facilities.

### Applicability

Rooftop-CourtyardWH provides a safe and convenient source of good quality water (but of limited quantity) in a context where other sources are either less convenient or dirtier.

Improved water availability	
Drinking water (high quality)	++
Domestic use (household)	+++
Livestock sedentary	++
Livestock pastoral	n/ap
Rainfed agriculture	n/ap
Opportunistic irrigation	n/ap
Supplementary irrigation	+
Irrigation of backyard crops / kitchen gardens	+++
Aquifer recharge	n/ap
Agro-processing	++
Development issues addressed	
Preventing / reversing land degradation	n/ap
Maintaining and improving food security	+
Reducing rural poverty	++
Creating rural employment	++
Supporting gender equity / marginalised groups	+++
Reduced risk of production failure	+
Improving crop production (including fruit trees)	+
Improving fodder production	n/ap
Improving wood / fibre production	n/ap
Improving water productivity	++
Trapping sediments and nutrients	n/ap
Enhancing biodiversity	+
Natural disaster prevention / mitigation	+
Climate change mitigation	+/-
Climate change adaptation	
Resilience to extreme dry conditions	+
Resilience to variable rainfall	++
Resilience to extreme rain and wind storms	+++
Resilience to rising temperatures and evaporation rates	+++

Importance: +++ high, ++ medium, + low, +/- neutral, n/ap: not applicable

### Resilience to climate variability

A certain amount of regular rainfall is required, thus prolonged droughts will be a problem. Compared with most alternative sources, Rooftop-CourtyardWH is robust in the face of extreme rain storms – although the storage facility will limit the amount captured. In periods of water excess water cannot be stored.

### Main benefits

- Increased availability of relatively clean, reliable and affordable water for drinking, domestic use, sanitation, animal consumption, irrigating kitchen gardens and other income generating activities.
- Reduced workload especially for women, who are responsible for many household tasks and thus reduced women’s health problems connected to carrying water.
- Possibility of storing water during the rainy season and using it during the dry season.
- Management of water at household level and therefore avoiding water conflicts related to water management at the community level.

### Main disadvantages

- Possible danger of contamination of water such as high level of phosphate from bird drops and dust accumulated on a house roof, which is washed into the storage vessel.
- Reliance on relatively reliable rainfall and adequate storage capacity

### Benefit-cost ratio

Installation of Rooftop-CourtyardWH system requires certain financial resources and labour availability, although once installed the running costs are often very small.

System	short term	long term
Manufactured WH system	--	+++
WH system made of simple method and materials	+ / -	+++
Overall	-	+++

-- very negative; - negative; - slightly negative; - / + neutral; + slightly positive; ++ positive; +++ very positive; (WOCAT, 2012).

### Adoption and upscaling

Rooftop-CourtyardWH must be profitable for land users, affordable and simple to install and manage. Communities have incentives to adopt these technologies, if the main water source is located far away, absent or polluted and if the payback from investing in Rooftop-CourtyardWH technologies is high enough. Incentives for more developed countries are to save money and live more ecologically.



Roof catchment in Kenya showing the different components of a rooftop WH system. (M. Malesu).



Example of RooftopWH in Kyrgyzstan. (L. Pluess, Helvetas)



Example of ferro-cement tank, Sri Lanka. (not known)



Courtyard or compound water harvesting applied on Lanzarote, Canary archipelago (W. Critchley).



Courtyard water harvesting, Palestine. (N. Harari)

## Types and Materials

### Catchment area

In a Rooftop-CourtyardWH system, house roofs and courtyard surfaces are used as catchment areas.

**RooftopWH:** Roof materials facilitating water harvesting consist of various materials depending on technology, natural conditions and affordability. The two main requirements for a roof to be used for Rooftop WH are:

- 1) A roof must be easy to connect to gutters and there must be some method of attaching the gutters under the roof.
- 2) The water that comes from the roof should be free of contaminants, particularly dissolved material.

**Galvanized iron or aluminium sheets:** These provide a very smooth surface for rainwater runoff, and high temperatures help to kill bacteria. The same material can be used as a cover for a storage tank. This, however, is a relatively expensive material and unaffordable in some low income countries.

**Corrugated cement sheets:** Corrugated cement sheets are commonly used and are an excellent roof-covering material. They provide comparatively clean water and are easy to construct.

**Asbestos sheets:** Asbestos was, especially in the past, been used in some countries as a roofing material. New sheets can give comparatively clean water – while older roofs harbour mould or even moss. Most importantly, asbestos roofing can itself contaminate the water constituting a considerable health hazard, and should therefore be avoided.

**Tiles and slates:** Tiles from fired clay yield high quality water. Tiles are of different shapes and sizes. Contamination can exist in tile joints, and unglazed tiles can harbour mould. Slates are suitable for RooftopWH as they absorb very little water and are relatively resistant to weather conditions. They are more commonly used in developed countries.

**Organic roof covering:** Common in the tropics, these include thatch, palm, bamboo or wood tiled (shingles) roofs with or without plastic covering. These are used in many low income countries and provide comparatively poor quality water. The collected water is turbid and the dissolved organic material cannot be easily filtered out. In addition, such organic roofing generates relatively little runoff. And, as associated roofs are sometimes rounded and steeply sloping, application of guttering is difficult. If plastic covering is applied, it must be removable to be protected from dust and sunlight when it is not raining. In general, covering an organic roof with plastic is not desirable because such sheeting prevents natural ventilation through the roof, and moisture trapped below causes the organic material to rot.



Corrugated iron sheets for roofing. (HP. Liniger)



Secondary School Rainwater Harvesting Project Kenya (Water Charity, 2012).



Rooftop WH system with rainwater collected from an organic roof. (www.infonet-biovision.org)

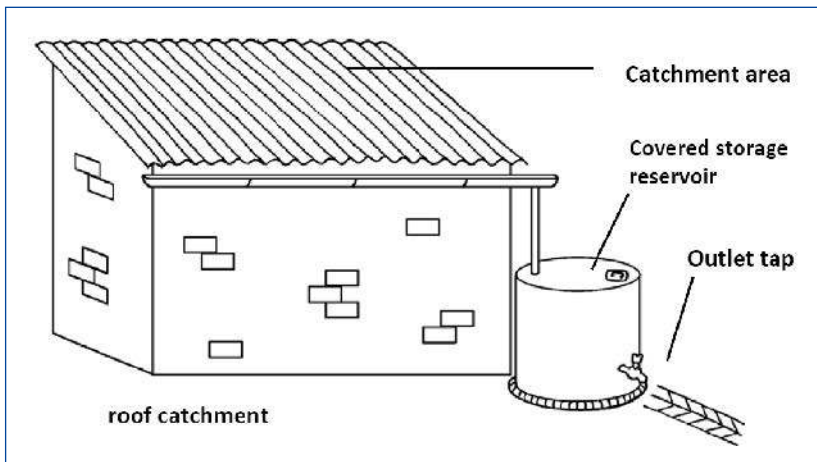

Rooftop water harvesting system. (UNEP IETC, 1998 in Clements et al., 2011)



A simple Rooftop WH system supplying drinking water, Madagascar. (J. Zähringer)

**CourtyardWH:** Rainwater can be collected from ground surfaces which are either compacted, paved or laid out with plastic sheeting, in and around the courtyard. The slope and water permeability (the “runoff coefficient”) of the top layer affects the amount of rainwater that can be collected. The water can be stored above or below ground. Rainwater is collected from flat surfaces (e.g. courtyards) and delivered into a tank below ground. The water harvested using this method is of low quality and some can be lost due to infiltration. To maximize the quantity of water collected, the ground must be cleared of vegetative cover and the soil compacted to reduce permeability, while to increase the quality a filter is necessary at the opening of the water storage facility. Such filters prevent stones and also sand from entering. In an area with 500 mm annual rainfall, an impermeable ground surface of 100 m<sup>2</sup> can potentially harvest 50 m<sup>3</sup> of water during one year – though this assumes no losses, and 40–45 m<sup>3</sup> is more realistic.



Ground-surface WH in China. (HP. Liniger)

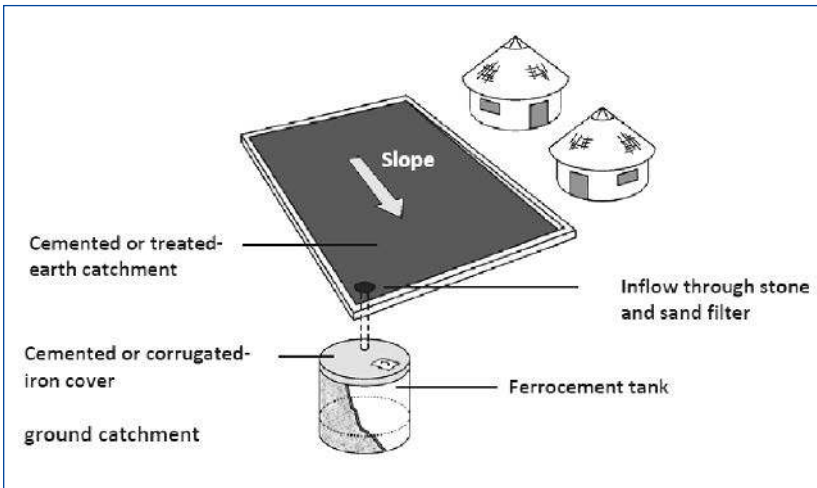

Courtyard catchment system including cemented ground (a road could equally act as a catchment), an underground ferro-cement tank with a cemented, corrugated iron or tiled cover (UNEP IETC, 1998 in Clements et al., 2011).

**RoadWH close to the homestead:** An asphalted (or murrum) road, track or foot-path with drainage can contribute as an additional source of WH to domestic use. The water collected by this type of WH is directed into an underground facility (e.g. a cylindrical ground tank) similar to courtyard WH described above.

**Combined system:** RooftopWH can be combined with CourtyardWH and RoadWH. Since water from RooftopWH is normally of better quality than water harvested from ground-surface and roads, it is advisable to keep one tank for RooftopWH separately. Excess water discharged through an overflow pipe can be directed towards a combined storage facility to maximize water storage.

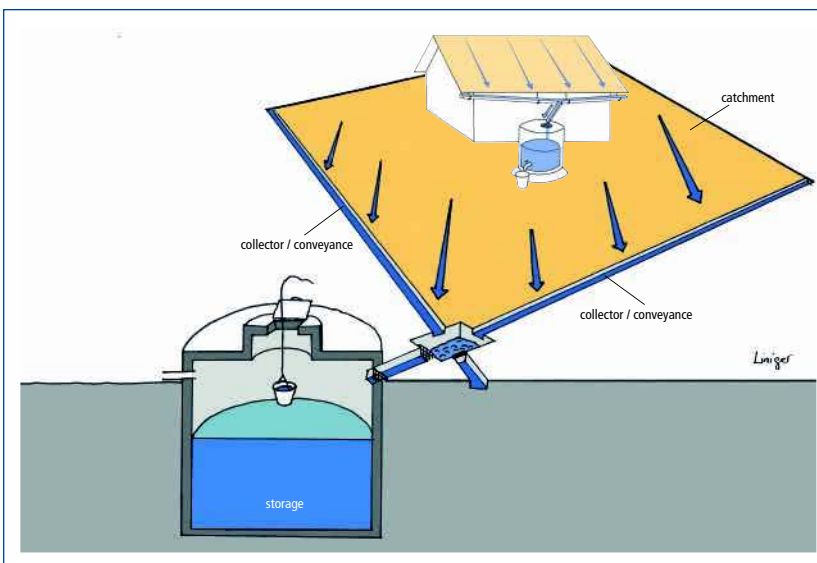

Combined Rooftop-CourtyardWH system.

**Example: Tankas or kundis in India**

In eastern Kenya, a gully has been stabilised with Communities in Rajasthan commonly use the roofs of their houses as well as courtyards to collect rainwater. This technology, locally called *tankas* or *kunds*, is very important because the groundwater in these areas is saline and unfit for drinking. Rooftops here have a gentle slope so that water can flow into a pipe, which has provision for filtering out dirt and grains of sand, and delivering water into an underground tank. The size of these tanks varies, depending on local rainfall and catchment area. Courtyards are constructed with a mixture of sand and limestone, and have a slight incline. The incline is made either from one end of the courtyard to the other, or from all corners towards the center of the courtyard – and in this central point a *kund* is located. The *kund* is constructed so that no water can seep through its base. Water quality in *kunds* is very good (Mahnot, 2003).



Underground tank for courtyard and road water harvesting, Kenya. This tank was equipped with a silt trap and used for storing runoff (Nissen-Petersen, 2007).

## Conveyance system

Conveyance systems transfer roof runoff to the storage system. These comprise gutters that are either connected to downpipes or are extended to a point directly above the tank.

**Gutters:** Gutters come in different types, shapes and materials.

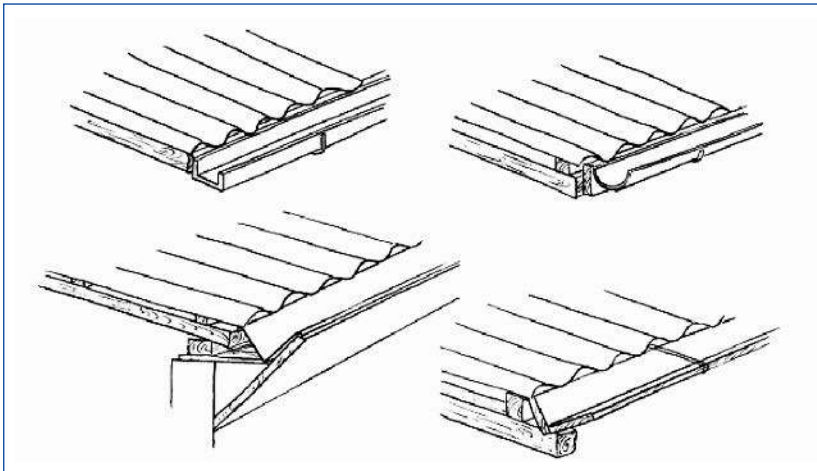

Square-sectioned, semi-circle, and V-shaped guttering with two different ways of attachment to the catchment area (Worm and Hattum, 2006)

**V-shaped gutters:** These are made by cutting and folding flat galvanized steel sheets. One of the simplest ways to construct a V-shaped gutter is to clamp the cut sheet between two lengths of straight timber and to fold the sheet along the edge of the wood. Edges are strengthened by folding the sheet by 90°, and then completing the edge with a hammer on a hard surface. But this type of gutter is easily blocked by twigs and leaves.

**Semi-circle gutters:** Plastic extrusion is the simplest way to make semi-circular gutters. Raw plastic material is melted and formed into a continuous profile. Alternatively gutters can also be produced by cutting a tube (or a bamboo pole) in half. Such gutters are not only cheap but also easy to clean.

**Square-sectioned gutters:** Metal sheets are folded and shaped by using a piece of wood to achieve a square section. This type of gutter is prone to silting.

**Wooden planks and bamboo gutters:** These are the cheapest form of gutters – practically free at the local level. However, they require frequent replacement. Moreover, they can be difficult to clean and runoff is often tainted.

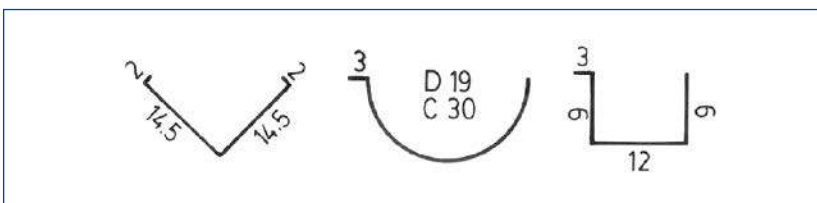

Dimensions of V-shaped gutter, square gutter and semi-circular gutter in centimeters (D: diameter, C: circumference) (Nissen-Petersen, 2007).

To avoid water overshooting the gutters, gutter guards or splash guards can be installed.

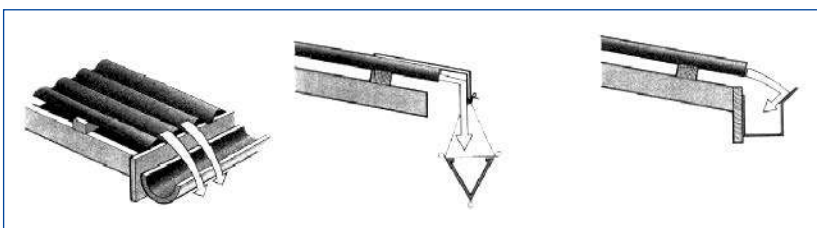

Water overshooting the gutter (left) and options to avoid water overflows (Skinner, 2003 in Doyle, 2008).



Semi-circular guttering with "circular" extended guttering. (C. Studer)



Manufacturing square-sectioned gutters from galvanized plain iron: shaping them with a piece of wood (Nissen-Petersen, 2007).

### Example: Guttering in Myanmar

The people in the Delta Zone of Myanmar often use bamboo and plastic sheets as materials for guttering.



When rain is expected the house owner attaches a wide and removable gutter made of plastic sheet below the roof.



For more permanent guttering bamboo is split, tied to a few sticks and fastened with a gradient to the rafter of the house.

(Nissen-Petersen, 2007)

**Extended gutters:** In this arrangement the guttering is connected to a storage tank beyond the roof edge of the building, with its center in line with the guttering. Gutters are extended with a slight gradient towards the tank inlet. Sometimes, tanks are installed directly under the gap between both ends of the gutter (one coming from the right and another from the left). In this case, runoff from the two gutters meet and fall together into the storage vessel.

**Separate open channel:** This is a simple method in which guttering is extended slightly beyond the end of the building, with a hole in the gutter to allow the water to fall. A separate open channel at a slight gradient and at an angle to the roof gutters is installed where the water falls and through this channel water is diverted into the tank inlet. The tank no longer needs to be in line with the roof edge. This method connects both the front and the back of the building's roof to a single tank.

**Downpipes:** These are made of metal, plastic or other locally available materials. There are special watertight fittings to connect down pipes directly to the underside of gutters. Downpipes should have similar cross-sectional dimensions to the gutters.

**Overflow pipes:** Overflow pipes are installed on the upper side of the storage tank, to allow excess water to be disposed of safely during heavy and prolonged rainfall events. The size of the overflow pipe is normally the same as that of the inlet / conveyance pipe. At the bottom a mesh is installed to prevent cockroaches, rats or squirrels from entering. The mesh may need to be replaced from time to time.

### Filtering

Debris needs to be filtered out to prevent pollution of the storage facility.

**Coarse filters:** A grid / mesh is installed between the gutter and overflow pipe or entrance to the water storage facility. The grid should be big enough (about 5 mm) to allow water to flow into the tank without hindrance. The filter is removed and cleaned regularly.

**Fine filters:** As an alternative, fine filters based on fine mesh are sometimes used for Rooftop WH systems. These filters however can be problematic as people often simply remove such filters when they become blocked, or in the best case, replace them with coarser filters. In high-income countries self-cleaning filters are available with a 0.4 mm mesh screen, in which the first flow of water is used to flush the filter during each rainfall event.

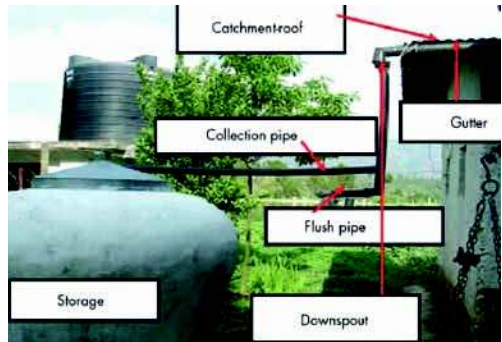

Elements of a RooftopWH system in Nepal (ICIMOD, 2009).



"Cascading gutters" of a RooftopWH system for domestic use in Mallorca, Spain (Barron, 2009).



A fallpipe made of old plastic bottles stitched together by thin wire, Tajikistan. (S. Stevenson)

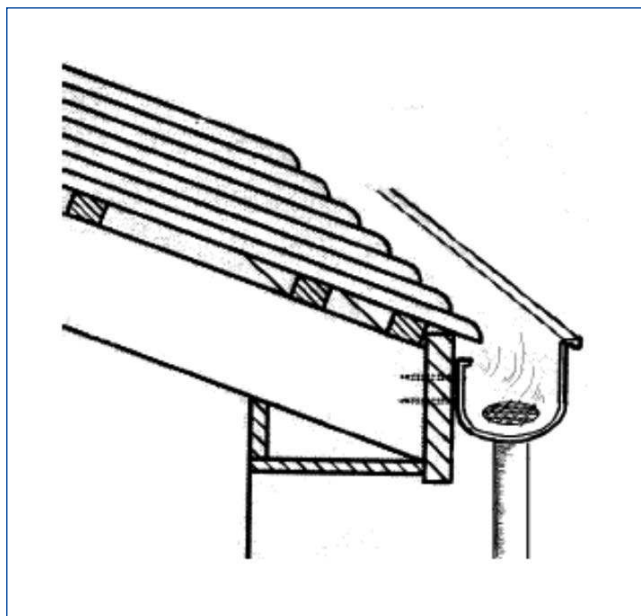

Coarse filter (Worm and Hattum, 2006).

### Example of filter in India

Several hundreds of rock catchment dams have in India a filter made of gravel, sand and mesh placed on top of a storage tank is used to keep stored water clean. It prevents leaves, dust, silt and other organic matter from entering the tank. The filter material is cleaned after every rain, because preventing rainwater from readily entering the storage tank may result in the filter overflowing. The gravel and sand is taken out and washed and only then placed back in the filter.



A filter with mesh, sand and gravel used in Karnataka, India (Rainwater Club, not dated).

**Diversion:** Discharging the first dirty roof runoff water is termed 'first flush diversion'.

**First-flush diversion:** This is a process, during which the first flow of runoff, which usually contains contaminants washed from the roof, is removed. The simplest technique is to move the downpipe aside by hand at the start of the rainfall, so that the first runoff does not fall into the tank. In many high-income countries automatic diverters are used.

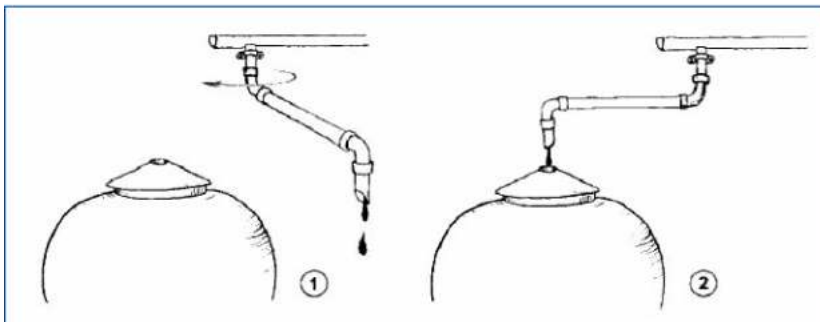

Manual method for separating first-flush (Worm and Hattum, 2006).

**Fixed mass system:** This system is sometimes used instead of a manual first-flush diverter, as the latter method depends on the user being available during the first rain. The fixed mass system relies on a mass of water to tip a bucket or seesaw.

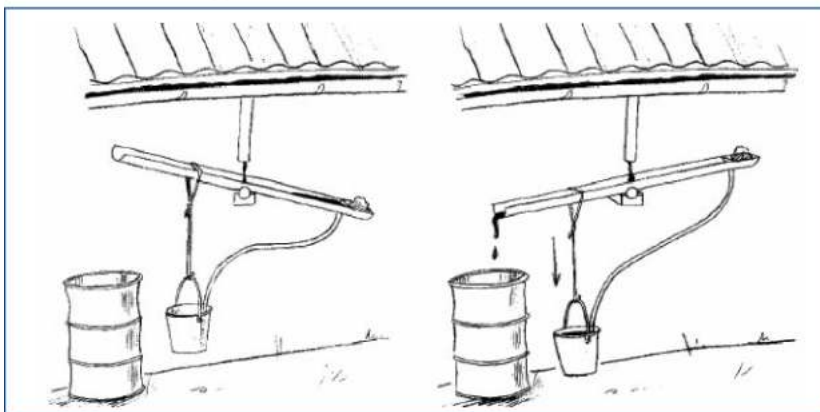

Fixed mass system (Worm and Hattum, 2006).

**Floating ball:** The floating ball, also known as SafeRain system, is an automatic first flushing method. A diversion chamber is installed in the conveyance pipe between the gutter and storage facility, so that the first, dirty, runoff flows into the chamber. Once it is filled up, the cleaner water bypasses the chamber and flows into the tank. To prevent the clean water from mixing with dirty water in the chamber, the design includes a ball. As the water level rises and the chamber fills up, the floating ball also rises and eventually reaches the top and blocks the entrance into the chamber. After each rain, the chamber is emptied before the next event. The system has the advantage of being self-cleaning and removes the need for any storage of the first-flush water.

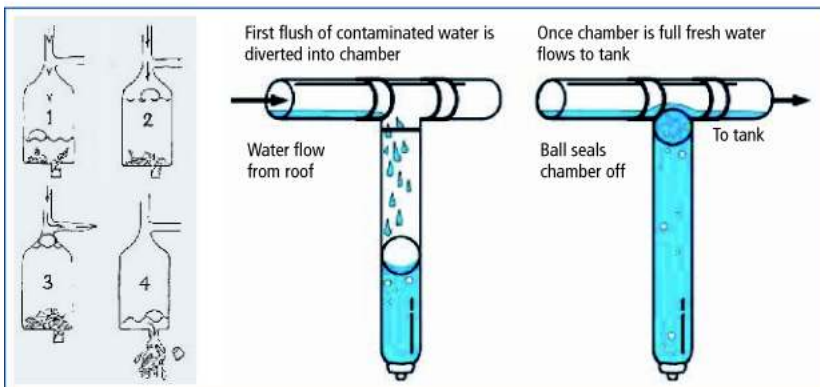

First flush diverters with floating ball. Left described by Worm and Hattum (2006) and right by Doyle (2008).

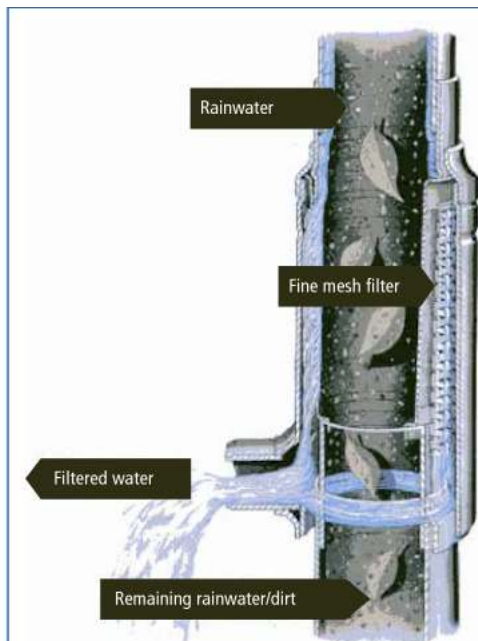

**Combined filtration system in Germany**

The German company WISY developed an ingenious filter that acts simultaneously as a filter and first-flush system. The filter takes in water through a very fine mesh (about 0.20 mm) and allows debris and silt to continue down the pipe (Practical Action, 2008).



Plastic tank with a first flush system, Kenya (Stevenson, 2007 in Doyle, 2008).



## Storage facilities

Water collected from roofs is usually stored in a closed facility, which may be above or below ground and of various designs. The main requirement for these facilities is that they should be well-protected against loss of water through seepage or evaporation. All facilities made of cement bricks and masonry work need a solid and weathering resistant foundation.

### Above ground

**Ferro-cement tank:** Ferro-cement tanks constitute a comparatively inexpensive technology, which requires little maintenance and can last long. The tank is made, using a solid mould of either corrugated or flat galvanised steel sheet made in curved sections that bolt together forming a cylinder. Mesh is wrapped around this mould and galvanised wire wound in a spiral around the tank with smaller spacing at the bottom and larger spacing at the top. The mesh is then plastered over with mortar, which is left to cure overnight. The form is then dismantled and the inside plastered with mortar. Most of these tanks are then lined with cement slurry that renders them waterproof; others use a waterproofing agent in the main mortar coating (Thomas and Martinson, 2007). A special mould construction is needed for the covering of the tank. Among the most popular ferro-cement tanks, is the straight cylinder design using sheet metal for the mold. Even though these tanks are considered a "low skill" technology, the workmanship still remains crucial. This type of storage vessel is widespread in South Africa, Sri Lanka and Thailand.

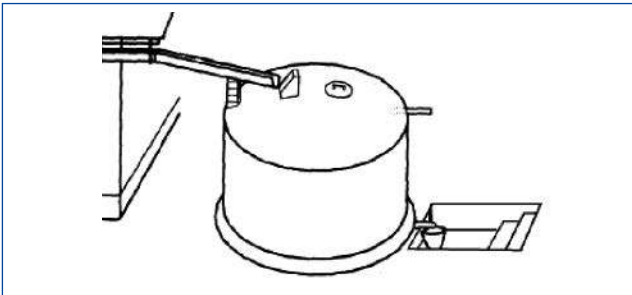

Ferro-cement tank (Worm and Hattum, 2006). HP Bilderreihe

### Ferro-cement water jars or jumbo jars (also known as pumpkin tank):

These are commonly used in Asia (e.g. Nepal, Thailand) and particularly favoured by women, who can construct them on their own. They consist of concrete with bamboo sticks or chicken wire to provide the shape and strength of the structure, and are placed 90 cm from the wall of the house the point where the water falls. The construction of these jars normally begins after the rainy season: this ensures that the ferro-cement dries slowly and solid construction is achieved.

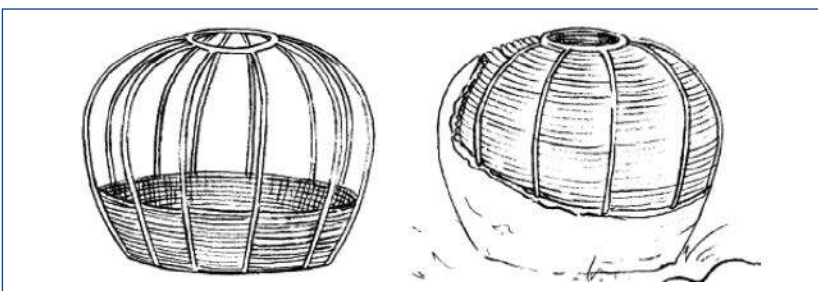

Construction of a water jar with a frame of iron bars or bamboo sticks covered with cement (Worm and Hattum, 2006).

**Drum tanks / oil drums:** These simple and cheap options are commonly found in Africa and Asia. They are suitable for use in crowded settlements, where space is limited and roofs are small, but also in poor rural households (e.g. rural Uganda). The capacity of such tanks is usually 200 litres (the capacity of the empty oil drum most commonly used, and almost always less than 1,000 litres). This is an economically appropriate size considering the alternative water sources which are usually available in urban area. Comparatively poorer household often prefer to use this type of facility for Rooftop WH because it is cheap, portable and can be installed quickly. Water quality collected using this technology, though, is poor as (a) most drums have previously contained oil, (b) they are often uncovered and thus provide an ideal environment for mosquito breeding and (c) water extraction is made by dipping a cup, which may result in contamination of the water.



A ferro-cement tank at a local school in Burkina Faso. (WaterAid / Chris Leake)

### Example: Jars used in Thailand

In Thailand jars are utilised as an inexpensive and appropriate means of storing rainwater from rooftop runoff for drinking. Prior to introduction of this storage facility, communities did not know how to protect water from waste and mosquitoes. Introduced jars were of various sizes (from 100 to 3,000 litres). A 2,000 litre jar is among the most commonly used. It stores sufficient rainwater for a six-person household during the dry season, lasting for almost 6 months (UNEP, 2002).



Rainwater jar used in India. (RAIN)



Rainwater harvested from roof into a drum tank. (HP. Liniger)

**Brick tanks:** Made of locally available backed bricks, cut stones, compressed-soil blocks, concrete and quarry. Usually such tanks are built by local people, as the technique is similar to that of constructing a circular building. However, if it is a cylindrical tank with a small diameter, poorly fitting bricks can require more cement than an equivalent ferro-cement storage facility. The size of the tank depends on the quantity of rainfall. Brick tanks are used for example in Sri Lanka and Uganda. In Nepal, for instance, traditional brick tanks have a capacity of about 25,000 litres.

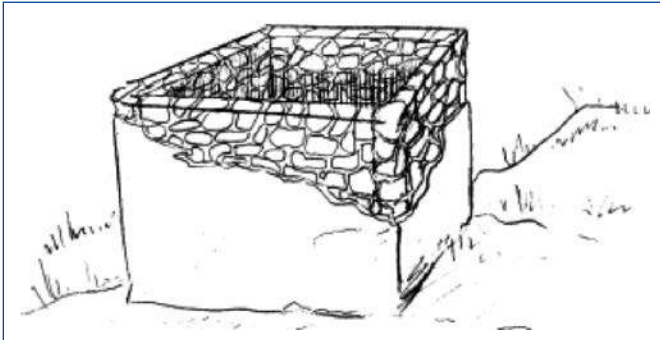

Brick / stone tank (Worm and Hattum 2006).

**Pre-cast tanks:** These are commonly used in high-income countries such as Germany and Australia. Such tanks are cast under controlled factory conditions (in sizes up to 35 m<sup>3</sup>), delivered by trucks and installed by cranes. In Germany tanks are usually installed underground to economise on space. There have also been attempts to implement this technology in low-income countries like Brazil and Kenya using shuttering with corrugated iron. But adoption proved slow as the technology was quite expensive for these countries.

**Plastic tanks:** First popular in higher income countries. In transition and low-income countries these tanks are generally considered too expensive but are getting cheaper and popular due to advancements in local mass production. Plastic tanks are usually made from high-density polyethylene, or glass reinforced plastic, using a complex process. They are light to transport, quick to install.

#### Underground tanks

In some countries, low cost tanks are constructed underground as the earth supports the water pressure load. Because these tanks need not have a flat base they can have diverse shapes such as reverse domes bottoms. If the soil is ideal, the advantage of such tanks can result in material reduction in the order of 50%. In addition, underground tanks can be made by household members and unskilled persons.

#### Partially below ground cement-lined tank

Similar to underground tanks these partially below ground tanks (6,000 to 10,000 litres) are used in Uganda, where this type of water storage facility was introduced as a part of a WH research and development project in 2002. Masons were trained and payments for the construction were made by households themselves. Soon after, more than 1,000 such tanks were constructed the region.



Tanks using sheet metal in Macquiere Bay, Australia (Barron, 2009).

#### Example: Rooftop RWH in Japan

Rojison is a simple and unique rainwater harvesting and utilization facility at the community level, which has been made by local people in the Mukojima district of Tokyo to harvest rainwater from rooftops of private houses. The water is used for garden watering, fire-fighting and drinking water emergencies. Today, about 750 private and public buildings in Tokyo have introduced this system and rainwater collection is flourishing (UNEP, 2002).



Organic roof with an additional plastic covering and partially below ground tanks in rural Uganda (Danert and Motts, 2009).



Cement-lined underground tank in construction, Ethiopia. (HP. Liniger)

## Spread and applicability

### Spread

**Rooftop:** worldwide; e.g. Botswana, Burkina Faso, Ghana, Kenya, Nigeria, Senegal, South Africa, Uganda in Africa; China, Kyrgyzstan, India, Indonesia, Japan, Nepal, Sri Lanka, Tajikistan, Thailand in Asia and Brazil, Australia, Germany, Spain

**Courtyard:** e.g. China, India, Jordan, Kenya, Palestine, Syria

### Applicability

**Land use:** Settlements, courtyards, kitchen gardens.

**Water use:** Rainwater harvested from rooftop usually provides water for domestic use (drinking water, washing, sanitation etc.), irrigation of small-scale kitchen gardens and livestock consumption. Rainwater collected from courtyards is of poorer quality and therefore usually not used for drinking.

**Climate:** Rooftop-CourtyardWH systems are mainly applicable in areas where three successive months per year have negligible rainfall and in areas where annual rainfall is over 1,000 mm but where the dry seasons is long (up to five successive months with negligible rainfall). However, there are cases where these storage systems were also used in very humid areas in attempt to reduce overflow of the drainage systems in settlements and out of ecological reasons. Some examples of annual rainfall where Rooftop-CourtyardWH is applied are: 250–500 mm (Botswana); 500–750 mm (Tajikistan); 750–1,000 mm (Nepal), 1,700–2,500 mm (Tonga).

### Roof area required (m<sup>2</sup>/person) under different rainfall regimes

	Rainfall	700 mm	1000 mm	1500 mm	2000 mm	>2500 mm
<b>Use of water</b>		Roof area needed (m <sup>2</sup> /person)				
<b>Sole source of water</b> (95% of demand at 20 lcd*)	Large tank	14.5	10	6.5	5	4
<b>Main source</b> (70% of demand of 20 lcd in wet season, 14 lcd in dry season)	Medium tank	11.5	8.5	5.5	4	3
<b>Wet season source only</b> (95% of demand)	Small tank	8	5.5	4	3	2.5
<b>Potable water source only</b> (95% of demand at 7 lcd)	Small tank	6.5	4.5	3.5	2.5	2

\* lcd: liters per capita per day  
(adapted from Thomas and Martinson, 2007).

**Scale:** Rooftop-CourtyardWH systems constructed at private households are directly and entirely managed at household level. Management of the systems constructed at institutional buildings (schools, hospitals etc.) often require management clarifications.

**Land ownership and land / water use rights:** Since Rooftop-CourtyardWH technologies are usually established on individually titled land of a private household / school the WH system user has the full right to utilization of the water.

**Skill / knowledge requirements:** While simple Rooftop-CourtyardWH systems do not require detailed technical knowledge, more complex systems require skilled labour especially for the storage facilities. Therefore, where labour is expensive it is advisable to introduce simpler types.

**Labour requirements:** Comparatively low labour requirements; most demanding is the construction of the storage tanks.

### Land use

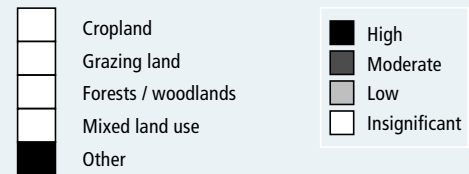

### Water use

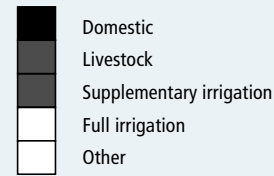

### Climate

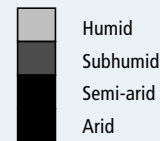

### Average rainfall (mm)

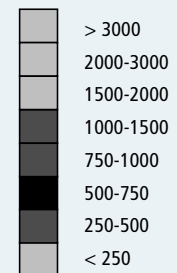

### Slope (%) not applicable

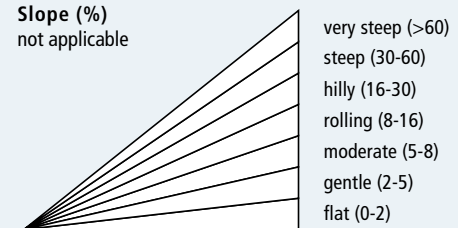

### Scale

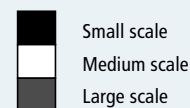

### Land ownership

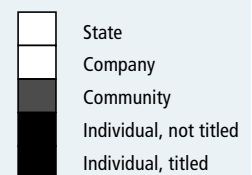

### Mechanisation

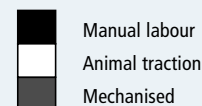

### Market orientation



### Required labour

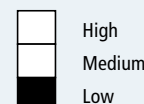

### Required know-how

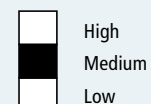

## Economics

### Costs

#### Cost examples of different Rooftop-CourtyardWH practices per

Technology	Country	Volumen m <sup>3</sup>	Establishment costs	Maintenance costs
Galvanised iron roof feeding underground concrete and mortar tank	Bots-wana <sup>1</sup>	22	2,000	13 (labour cost)
Water cellar / underground tank	China <sup>2</sup>	20–30	280	30
Ferro-cement jar	Nepal <sup>3</sup>	2	130	15 (cleaning and flushing the jar)
Polyethylene lined earth retention tank	Tajikistan <sup>4</sup>	12	30	9 (to change plastic sheet)
Concrete tanks and gutters	Tajikistan <sup>4</sup>	16	400	5 (labour for cleaning)
Concrete in situ tanks	Kenya <sup>5</sup>	5	650	
Burnt brick tank	Kenya <sup>5</sup>	10	1,065	
Soil compressed blocks tank	Kenya <sup>5</sup>	15	1,210	
Rubble stone tank	Kenya <sup>5</sup>	12	1,045	
Ferro-cement tank	Kenya <sup>5</sup>	3	360	
Ferro-cement tank	Kenya <sup>5</sup>	11	830	
Ferro-cement tank	Kenya <sup>5</sup>	23	1,220	
Ferro-cement tank	Kenya <sup>5</sup>	46	1,695	
Ferro-cement ground tank	Kenya <sup>5</sup>	90	2,555	

<sup>1</sup> J. Althopheng in Schwilch et al., 2012; <sup>2</sup> Y. Wang in Jiang et al., 2008; <sup>3</sup> M. Dhakal in NEPCAT, 2008;

<sup>4</sup> D. Domullojonov and S. Odinashev in Wolfigramm, 2011; <sup>1-4</sup> in WOCAT, 2012; <sup>5</sup> Nissen-Petersen, 2007; Knoop et al., 2012.

The cost of a tank, gutters, downpipes and filtration systems depend on volume, material, design, and on where and how they are constructed. Normally, one large tank is 30% cheaper than two small tanks of the same total volume. Therefore, the benefits depend on how much land users are willing to invest. Importantly, although initial investment might be high, some tanks used for RooftopWH have a long lifetime (up to 20 years) and therefore costs are low if spread over this period. An example from Senegal shows that with a US\$ 600 investment and a water tank with an average lifespan of 15 to 20 years, the annual costs of the structure would be around US\$ 40. This is a low-cost, effective and sustainable water supply option for areas which suffer water quality or quantity problems (Van Steenbergen and Tuinhof, 2009).

### Benefits

With a seasonal rainfall of 260 mm, which is quite common in arid and semi arid regions, and a roof surface of 100 m<sup>2</sup>, a total of 24'700 l can be harvested. In arid and semi arid regions, the minimal demand for domestic water supply is 6 l per day per person (Nissen-Petersen, 2007 cited in Knoop et al., 2012).

#### Example: Water availability through rooftop water harvesting

In an area with an average annual rainfall of 1,000 mm the potential of rooftop WH for a 250 m<sup>2</sup> plot (assuming that 50% of the plot area is roof area) would be 125,000 litres (0.5\*250\*1,000). Supposing that only 60% of the rainwater is stored (losses include evaporation and overflow), the amount of water available in a year would be 75,000 litres per year (0.6\*125,000). The water amount available per day would be 250 litres per plot (75,000/ 365) and if we assume that a family consists of 5 members, then the availability of water would be 50 litres for a person per day. Considering that the average domestic water requirement of a person is about 100 litres/ day, rooftop WH has a potential to satisfy half of the person's daily water requirement if water storage capacity is sufficient to bridge dry periods (UN-HABITAT, not dated).

#### Costs of RooftopWH per structure (median)



Costs for the establishment of RooftopWH structures range from US\$ 28 to 2,012 per structure. Equipment is the main factor determining establishment costs for RooftopWH.

Source: 4 case studies from the WOCAT database (WOCAT, 2012).



A couple in a Ugandan village building a WH jar at their home. (WaterAid/ Caroline Irby)



A rainwater storage tank constructed by householders in Nepal. (RAIN)



Water collected from RooftopWH system used for irrigating a kitchen garden. (RAIN)

## Impacts

Benefits	Farm level / household level	Community / watershed / landscape level
Production / Economic	<ul style="list-style-type: none"> <li>+++ safe water for human consumption after proper treatment against diseases</li> <li>+++ increased water availability / quality</li> <li>+++ diversification of water supply</li> <li>+++ reduced costs through less water bought</li> <li>+++ labour made available for income generating activities</li> <li>++ increased water availability for livestock</li> <li>++ low maintenance costs</li> <li>++ construction materials (usually) locally available</li> <li>++ irrigation of larger kitchen gardens / plots</li> <li>+ increased crop production</li> </ul>	<ul style="list-style-type: none"> <li>+++ increased water availability / quality</li> <li>+++ market for technical material and installation specialists</li> <li>+++ reduced demand for surface and groundwater</li> <li>+ reduced risk of production failure</li> </ul>
Ecological	<ul style="list-style-type: none"> <li>+++ increased water quality / quantity</li> <li>+++ reduced storm water runoff</li> <li>++ increased water availability in dry season</li> </ul>	<ul style="list-style-type: none"> <li>+++ reduction of pressure on surface and groundwater resources</li> <li>+++ reduction of runoff from roofs and courtyards decreases damage and erosion around settlements and neighbouring fields</li> </ul>
Socio-cultural	<ul style="list-style-type: none"> <li>+++ improved health due to safe drinking water</li> <li>+++ water is provided at the point of use</li> <li>+++ improved hygiene (if access to sufficient water quantities was a problem)</li> <li>+++ workload is reduced, especially for women</li> <li>+++ back strain and injuries from carrying heavy water containers are reduced</li> <li>+++ the systems are often managed by individual land users, which can be an advantage as communal management is often afflicted with conflicts</li> <li>++ only option to assure water supply for many small tropical islands and other regions without reliable surface and ground water</li> <li>++ households have full control over the system</li> <li>+ applicable to rural as well as to urban areas</li> <li>+ local people can be easily trained in construction and maintenance</li> </ul>	<ul style="list-style-type: none"> <li>+++ availability of water at schools, community centres and health posts</li> <li>+++ community institution strengthening</li> <li>+++ improved situation for economically and socially disadvantaged groups</li> <li>+ improved food security</li> </ul>

Importance: +++ high, ++ medium, + low

	Constraints	How to overcome
Production / Economic	quantity of water harvested too small to cover entire household needs	→ invest in an additional tank
Socio-cultural	microbiological contamination with high levels of phosphate from bird droppings and dust accumulated on roofs	→ the first part of the runoff, usually full of contaminants washed from roof, must be removed using first-flush diversion
	poorly constructed water tanks can suffer from algal growth and invasion of insects and lizards, and may act as a breeding ground for disease vectors	→ check and clean tanks regularly
	water storage facility can be dangerous for small children rats or mice can damage a storage tank	→ provide proper access protection

## Adoption and upscaling

### Adoption rate

Despite the huge potential of Rooftop-CourtyardWH in low income countries, the adoption rate is low but growing. In transition countries like China and India RooftopWH is gaining ground due to local mass production of water collection and storage facilities. In high income countries like UK, Germany and the United States, adoption rates have slightly increased over the last years for a variety of environmental and economic reasons.

### Enabling environment

**Profitability:** In most cases construction of Rooftop-CourtyardWH systems cost a significant amount of money, therefore adoption depends on whether it is cheaper than any alternative. Depending on location, systems need to be simple and inexpensive: in this context the availability of local materials must be taken into account. Initial material support might be needed for the poorest communities.

**External support:** Organizations, local government, self-help groups and trained extension services are all needed to spread Rooftop-CourtyardWH techniques. Local government and public involvement might be necessary in improving the quality of household Rooftop-CourtyardWH systems or limiting the power of water supply companies that prohibit spreading of WH systems. Supporting organizations or the government may need to help with subsidies, through establishing revolving funds for capital costs or setting up micro-credit scheme.

**Capacity building and knowledge sharing** is required. Information, education and training are among the constraints impeding adoption. It is advisable to build WH systems upon local household experience. As this promotes replication, enlargement or improvement of WH systems.

**Incentives:** Trainings on types of system and methods of construction is essential, since people often lack knowledge. Depending on the size and type of the system, a household needs to make some investment, hence there should be potential access to microcredit or loans.

**Suitable approaches:** WH demonstration systems and training local specialists can be a suitable approach to promoting Rooftop-CourtyardWH. Market-led approaches, making available affordable WH facilities, can leverage household investments.

### Feasibility and planning

**Environmental aspects to be considered:** These include the amount and patterns of rainfall events in the area, availability of other water sources and duration of dry periods.

**Technical aspects to be considered:** All of the following are important – roofing material, catchment area (m<sup>2</sup>), water consumption rate, availability of other water sources, skilled labour, and construction material.

**Water consumption and management:** Household water demand should be estimated in consultation with local stakeholders and the responsibilities for establishing and maintaining the system should be clarified from the very beginning.

**Social and gender aspects:** The household / community must be in real need of better water provision and full involvement of the household / community is required to develop social cohesion. Moreover, existing local examples of positive experience can be very helpful. Establishment of the WH system reduces workloads – especially of women – who are often responsible for water fetching.

**Financial aspects:** Careful design with optimal storage capacity should be provided, while keeping the cost as low as possible. The design of the WH system must be cost-effective and affordable.

**Suitability:** Factors determining the design of the Rooftop-CourtyardWH system include: local rainfall patterns; number of users and their consumption rate; occasional, intermittent, partial or full use of rainwater; catchment area (m<sup>2</sup>); and the runoff coefficient of the catchment.

### Example: Adoption rates in Botswana and Tajikistan

In Botswana, there was no public uptake of rooftop water harvesting although demonstration schemes were installed in each village of Boteti sub-district. The reason was cuts in government subsidies. Building materials and the costs of a professional mason were not affordable anymore for the local population (J. Athlopheng in Schwilch et al., 2012).

In comparison, the adoption rates were high in Tajikistan for earth tanks as well as for more expensive concrete tanks. Land users observed the benefits obtained from their neighbours and decided it was worth the initial investment (D. Domullojonov and S. Odinoashoev in Wolfram, 2011).

#### Enabling environment: key factors for adoption

Inputs, material	+++
Incentives, credits	+++
Training and education	+++
Land / water use rights	+
Access to markets for inputs and outputs	++
Research	+
Genuine ownership on the part of communities	++

Importance: +++ high, ++ medium, + low

#### Feasibility and planning: key factors for implementation

Assessing water quantity to be harvested	+++
Assessing water quality	+++
Estimating water needs	+++
Site assessment	+
Financial aspects	+++
Environmental impact assessment	+/-
Land / water use rights	++
Neighbourhood relations	+/-
Community involvement	+
Social and gender aspects	++
Official governmental approval	+/-

Importance: +++ high, ++ medium, + low

### Example: Incentives provided by state in Indore, India

In Indore, India, RooftopWH has been made compulsory by legislation in all newly constructed buildings with an area of 250 m<sup>2</sup> or more. To encourage implementation of RooftopWH systems, the state offered a rebate of 6% on property tax (UN-HABITAT, not dated).



Steps for constructing a cement water tank using a plastic bag filled with straw. Drawing on tank shows design and material needed. (HP. Liniger)

### Example: Uganda

In Uganda an extensive range of manufactured or built-in-place Domestic Rain Water Harvesting (DRWH) storage facilities are in use. A study identified about 30 distinct DRWH storage products which include: 20-litre jerry cans; 50 and 100-litre blow moulded plastic drums; 200-litre steel drums; 420 to 1,500-litre cement jars; plastic tanks (Aquatank and Polytank) from 220 litres to 15,000 litres; above-ground plastic-lined tanks (3,000 litres); below ground plastic-lined tanks (10,000 litres and above); ferro-cement tanks (4,000 to 10,000 litres); partially below ground cement lined tanks (6,000 to 10,000 litres) and brick tanks (10,000 litres). Despite the enormous potential of DRWH and its promotion by the Government and NGOs, the adoption rate of the technology is low. Beside construction of demonstration facilities for self-help groups, training of local masons and encouragement of pooled group savings (merry go-round system) and offering of subsidies, more strategic interventions by Government, NGOs and the private sector are needed to accelerate growth in DRWH (Danert and Motts, 2009).

## References

- Barron, J. 2009. Rainwater harvesting: a lifeline for human well-being. United Nations Environment Programme (UNEP), Nairobi / Stockholm Environment Institute (SEI).
- Clements, R., Haggard, J., Quezada, A. and J.Torres. 2011. Technologies for Climate Change Adaptation: Agriculture Sector. Roskilde: UNEP Risø Centre on Energy, Climate and Sustainable Development.
- Danert, K. and N. Motts. 2009. Uganda Water Sector and Domestic Rainwater Harvesting Sub-Sector Analysis: EnterpriseWorks/VITA.
- Doyle, K.C. 2008. Sizing the First Flush and its Effect on the Storage-Reliability-Yield Behavior of Rainwater Harvesting in Rwanda. Master Thesis, Department of Civil and Environmental Engineering, Massachusetts Institute of Technology.
- Elliott, M., Armstrong, A., Lobuglio, J. and J. Bartram. 2011. Technologies for Climate Change Adaptation. The Water Sector. Roskilde: UNEP Risø Centre on Energy, Climate and Sustainable Development.
- Ferdausi, S.A. and M.W. Bolkland. 2000. Rainwater harvesting for application in rural Bangladesh. In 26th WEDC Conference on Water. Sanitation and hygiene: challenges of the millennium. Dhaka, Bangladesh.
- ICIMOD. 2009. Mountain Development Resource Book for Afghanistan. International Centre for Integrated Mountain Development (ICIMOD). Kathmandu, Nepal.
- Jiang, Z. (director editorial board) et al. 2008. Best practices for land degradation control in dryland areas of China. Land Degradation Assessment in Drylands (FAO-LADA), World Overview of Conservation Approaches and Technologies (WOCAT) and PRC-GEF Partnership on Land Degradation in Dryland Ecosystems, China.
- Knoop, L., Sambalino, F. and F. Van Steenberg. 2012. Securing Water and Land in the Tana Basin: a resource book for water managers and practitioners. 3R Water Secretariat. Wageningen, The Netherlands.
- LaBranche, A., Wack, H.O., Crawford, D., Crawford, E., Sojka, N.J. and C. Brand. 2007. Virginia Rainwater Harvesting Manual. The Cabell Brand Center.
- Mahnot, S. 2003. Water Harvesting Management: improving land management in Rajasthan. SDC/Intercooperation Coordination Unit. Jaipur, India.
- NEPCAT. 2008. Natural Resource and Management Approaches and Technologies in Nepal. NEPCAT fact sheets. Centre for Integrated Mountain Development (ICIMOD). Kathmandu, Nepal.
- Nissen-Petersen, E. 2007. Water from Roofs: a handbook for technicians and builders on survey, design, construction and maintenance of roof catchments. ASAL Consultants Ltd., Nairobi, Kenya. For the Danish International Development Agency (DANIDA) in Kenya. <http://www.waterforaridland.com/Books/book7%20Water%20from%20roofs.pdf>
- Practical Action. 2008. Runoff Rainwater Harvesting. Technical Brief. The Schumacher Centre. Rugby, UK. [http://practicalaction.org/docs/technical\\_information\\_service/rainwater\\_harvesting.pdf](http://practicalaction.org/docs/technical_information_service/rainwater_harvesting.pdf)
- Rainwater Club. not dated. Manual on rooftop rainwater harvesting systems in schools: maintenance schedule, post storage treatment procedure and precautions. Rainwater Club. Bangalore, India. [www.rainwaterclub.org](http://www.rainwaterclub.org)
- Schauwecker C. 2010. A Water Harvesting Guide for Extension Workers: Water Harvesting Manual and Catalogue. Bern University of Applied Sciences, School of Agriculture, Forest and Food Sciences.
- Schwilch, G., Hessel, R. and S. Verzaandvoort (eds). 2012. Desire for Greener Land. Options for Sustainable Land Management in Drylands. Bern, Switzerland, and Wageningen, The Netherlands: University of Bern – CDE, Alterra – Wageningen UR, ISRIC – World Soil Information and CTA – Technical Centre for Agricultural and Rural Cooperation.
- Thomas, T.H. and D.B. Martinson. 2007. Roofwater Harvesting: a Handbook for Practitioners. Technical Paper Series; no. 49. International Water and Sanitation Centre (IRC). Delft, The Netherlands. <http://www.washdoc.info/docsearch/title/155697>
- UN-HABITAT. not dated. Measures for Ensuring Sustainability of Rainwater Harvesting. Water for Asian Cities Programme – UN-HABITAT, Directorate of Urban Administration and Development Government of Madhya Pradesh, India.
- UNEP. 2002. Rainwater Harvesting and Utilization: an environmentally sound approach for sustainable urban water management: an introductory guide for decision makers. United Nations Environment Programme (UNEP) Division of Technology, Industry and Economics. <http://www.unep.or.jp/ietc/Publications/Urban/UrbanEnv-2/index.asp>
- Van Steenberg, F. and A. Tuinhof. 2009. Managing the Water Buffer for Development and Climate Change Adaptation: Groundwater Recharge, Retention, Reuse and Rainwater Storage. UNESCO International Hydrological Programme. Paris.
- Water Charity. 2012. Conclusion of St. Martin Secondary School Rainwater Harvesting Project – Kenya.
- WaterAid. not dated. Rainwater harvesting. Technical Brief. WaterAid International NGO. London, UK. [http://www.wateraid.org/documents/plugin\\_documents/rainwater\\_harvesting.pdf](http://www.wateraid.org/documents/plugin_documents/rainwater_harvesting.pdf)
- WOCAT (World Overview of Conservation Approaches and Technologies). 2012. WOCAT Database: Technologies. <http://cdewocat.unibe.ch/wocatQT/index.php>.
- Wolfgramm, B. (coordinator). 2011. Sustainable Land Management (SLM) Technologies and Approaches in Tajikistan. Tajikistan Pilot Programme for Climate Resilience (PPCR). [https://www.wocat.net/fileadmin/user\\_upload/documents/Books/Tajikistan\\_wocat-collection2011\\_eng\\_final.pdf](https://www.wocat.net/fileadmin/user_upload/documents/Books/Tajikistan_wocat-collection2011_eng_final.pdf)
- Worm, J. and T. van Hattum. 2006. Rainwater harvesting for domestic use. AGROMISA and CTA / RAIN (Rainwater Harvesting Implementation Network). Wageningen, The Netherlands.

### Complementary references:

- African Development Bank. 2009. Rainwater Harvesting Handbook: Assessment of Best Practises and Experience in Water Harvesting. African Development Bank, Tunis. <http://www.rwsn.ch/documentation/skatdocumentation>.
- Ariyananda, T. 2009. Rain Water Harvesting Practitioners Guide for Sri Lanka. Lanka Rainwater Harvesting Forum.
- Baziwe, D. 2011. Putting women at the forefront in accelerating self supply through domestic rainwater harvesting. 6th Rural Water Supply Network (RWSN) Forum. Kampala, Uganda. November 2011.
- Danert, K and S. Sutton. 2010. Accelerating Self Supply: a case study from Uganda. Fieldnote No. 2010-4. Rural Water Development Technology Unit (DTU).
- Development Technology Unit (DTU). 2002. Very-Low-Cost Domestic Roof Water Harvesting in the Humid Tropics: Existing Practice. Domestic Roofwater Harvesting Research Programme, Report R1. Development Technology Unit, School of Engineering, University of Warwick. Warwick, UK. <http://www2.gtz.de/Dokumente/oe44/ecosan/en-very-low-cost-domestic-roofwater-harvesting-in-the-humid-tropics-2002.pdf>
- Development Technology Unit (DTU). 2000. Low-cost, thin-shell, ferrocement tank cover- Instructions for manufacture. DTU Technical Release Series, TR-RWH 04. Development Technology Unit, School of Engineering, University of Warwick. Warwick, UK. <http://www2.warwick.ac.uk/fac/sci/eng/research/structures/dtu/pubs/tr/rwh/tr-rwh04.pdf>
- Efe, S.I. 2006. Quality of rainwater harvesting for rural communities of Delta State, Nigeria. Environmentalist 26:175-181.
- Gould, J. and E. Nissen-Petersen. 1999. Rainwater catchment systems for domestic supply: design, construction and implementation. IT Publications. London, UK.
- Mendez, C.B., Afshar, B.R., Kinney, K., Barrett, M.E. and M.J. Kirisits. 2010. Effect of Roof Material on Water Quality for Rainwater Harvesting Systems. Report. Texas Water Development Board. Austin, Texas.



Naugle, J., Opio-Oning, T. and B. Cronin. 2011. A market-based approach to facilitate self supply for rainwater harvesting in Uganda. 6th Rural Water Supply Network (RWSN) Forum. Kampala, Uganda. November 2011.

Nega, H. and P.M. Kimeu. 2002. Low-cost methods of rainwater storage. Results from field trials in Ethiopia and Kenya. Regional Land Management Unit (RELMA). Nairobi, Kenya.

Nijhof, S. and B.R. Shrestha. 2010. Micro-credit and rainwater harvesting. International Water and Sanitation Centre (IRC) Symposium 2010: Pumps, Pipes and Promises: Costs, Finances and Accountability for Sustainable WASH Services. The Hague, The Netherlands.

Nissen-Petersen E. and M. Lee. 1990. Harvesting Rainwater in Semi-Arid Africa: Manual Number 1: Water Tanks With Guttering and Handpump. ASAL Consultants Ltd., Nairobi, Kenya.

Practical Action. 2009. Rainwater Harvesting in Uganda. The Schumacher Centre. Rugby, UK. <https://practicalaction.org/rainwater-harvesting-answers>

Practical Action. 2008. Underground Rainwater Storage Facilities. The Schumacher Centre. Rugby, UK. <https://practicalaction.org/rainwater-harvesting-answers>

Practical Action. 2002. The Sri Lankan Pumpkin Tank: A Case Study. The Schumacher Centre. Rugby, UK. <https://practicalaction.org/rainwater-harvesting-answers>

Practical Action. 1998. The Underground Brick Dome Tank (5 m3), Sri Lanka: A Case Study. The Schumacher Centre. Rugby, UK. <https://practicalaction.org/rainwater-harvesting-answers>

South Pacific Applied Geoscience Commission (SOPAC). 2004. Harvesting the Heavens. A manual for participatory training in rainwater harvesting. South Pacific Applied Geoscience Commission (SOPAC) for the United Nations Environment Programme (UNEP) in conjunction with the Tonga Community Development Trust (TCDT).

The Caribbean Environmental Health Institute. 2009. Rainwater. Catch it While You Can. A Handbook on Rainwater Harvesting in the Caribbean. A practical guideline featuring best practices for rainwater harvesting in small island Caribbean environments. The Caribbean Environmental Health Institute, St. Lucia / United Nations Environment Programme (UNEP), Nairobi.

UNEP-IETC (United Nation Environment Program: International Environmental Technology Centre). 1998. Sourcebook of Alternative Technologies for Freshwater Augmentation in some Asian Countries. IETC Technical Publication Series 8b, UNEP-IETC/Danish Hydraulic Institute.

Vilane, B.R.T. and E.J. Mwendera. 2011. An inventory of rainwater harvesting technologies in Swaziland. African Journal of agricultural Research. Vol. 6(6), pp. 1313-1321.

Waes, van B. and N. Bouman. 2007. Smart Water Harvesting Solutions: examples of innovative low-cost technologies for rain, fog, runoff water and groundwater. Water Partnership/ A4A/ Agromisa/ Partners for Water. Netherlands.

Zanzibar Water Authority. 2010. Zanzibar Rainwater Harvesting Manual for Training of Trainers for Domestic Supply.

#### Audio-visual media:

Water for Arid Land. 2010. Scope for rainwater harvesting in Eastern Africa – Interview with Erik Nissen-Petersen. Video. Produced by: The Water Channel. Language: English. Length: 04.18 min. [http://www.thewaterchannel.tv/index.php?option=com\\_hwdvideoshare&task=viewvideo&Itemid=53&video\\_id=615](http://www.thewaterchannel.tv/index.php?option=com_hwdvideoshare&task=viewvideo&Itemid=53&video_id=615)

Rain Harvesting. How to install and maintain a first flush water diverters? 2 Videos. Produced by: Rain Harvesting Pty Ltd. Language: English. Length: 1.02 and 1.55 min. <http://rainharvesting.com.au/products/pre-filtration/first-flush-water-diverter/downpipe-first-flush-diverter>

#### Networks:

Rainwater Harvesting Implementation Network (RAIN). Focus: Global. <http://www.rainfoundation.org>

Greater Horn of Africa Rainwater Partnership (GHARP). Focus: Horn of Africa. <http://www.gharainwater.org>

Centre for Science and Environment (CSE). Focus: India. <http://www.rainwaterharvesting.org>

Associação Brasileira de Captação e Manejo de Água de Chuva (ABCMAC). Focus: Brazil. <http://www.abcmac.org.br/index.php?modulo=english>

European Rainwater Catchment Systems Association (ERCSA). Focus: Europe. <http://www.ercsa.eu/home1.html>

Fachverein für Betriebs- und Regenwassernutzung Ev. Focus: Germany. <http://www.fbr.de/home.html>

Verband Regenwassernutzung Schweiz. Focus: Switzerland. [http://www.vrs-regenwassernutzung.ch/index.php?option=com\\_frontpage&Itemid=1](http://www.vrs-regenwassernutzung.ch/index.php?option=com_frontpage&Itemid=1)

Hawai'i Rainwater Catchment Systems Program. Focus: Hawaii. <http://www.ctahr.hawaii.edu/hawaiirain/>

RainWater Cambodia. Focus: Cambodia. [http://www.rainwatercambodia.org/activities\\_final.html](http://www.rainwatercambodia.org/activities_final.html)

Mvula Trust. Focus: South Africa. <http://www.mvula.co.za/>

The African Civil Society Network on Water and Sanitation. Focus: Africa. <http://www.anewafrika.org/about/index.php>

#### Implementing agencies:

Barefoot College. Focus: India. [http://www.barefootcollege.org/wat\\_approach.asp](http://www.barefootcollege.org/wat_approach.asp)

Eau Vive. Focus: Sahel (Senegal, Mali, Burkina Faso, Niger). <http://www.eau-vive.org/>

Fondo Hondureño de Inversión Social (FHIS). Focus: Honduras. <http://www.fhis.hn/programas/pas>

Hararghe Catholic Secretariat (HCS). Focus: Ethiopia. <http://www.hcsethiopia.org/page/water-sanitation>

Helvetas Swiss Intercooperation. Focus: Global. <http://www.helvetas.ch/wDeutsch/index.asp>

Plan (Promoting Child Rights to End Child Poverty). Focus: Global. <http://plan-international.org/>

Practical Action. Focus: Global. <https://practicalaction.org/rainwater-harvesting-answers>

Safe Water International. Focus: Sudan. <http://www.safewaterintl.org/page2/page8/page8.html>

Uthaaan NGO. Focus: India.

Water for Arid Lands. Focus: East Africa. <http://waterforaridland.com/asal.asp>

#### Recurrent events:

International Water and Sanitation Centre (IRC) Symposium 2013: Monitoring Sustainable Water, Sanitation and Hygiene (WASH) Service Delivery on 9 to 11 April 2013; Addis Ababa, Ethiopia. <http://www.irc.nl/page/72969>

Water, Sanitation and Hygiene (WASH) Sustainability Forum 2013 on 11 March, 2013; World Bank, Washington, D.C, USA. Hosted by: World Bank, UNICEF, Global Water Challenge, WASH Advocates, Aguaconsult, and the International Water and Sanitation Centre (IRC). <http://www.source.irc.nl/page/76191>

Africa Water Week (AWW) organized by the African Ministers Council on Water (AMCOW). <http://www.africawaterweek.com/index.php>

Asia Water Week 2013 on 13-15 March 2013; ADB Headquarters, Manila, Philippines. Organised by: Asian Development Bank (ADB). <http://www.source.irc.nl/page/72824>

Water Week Latinoamérica (WWLA) 2013 on 17-22 March 2013; Viña del Mar, Chile. Organised by: Fundación Chile and Diario Financiero, in collaboration with AIDIS, DesalData, Global Water Intelligence, and The Nature Conservancy. <http://www.source.irc.nl/page/75433>

India Water Week 2013 on 8 to 12 April 2013; New Delhi, India. Organised by: Ministry of Water Resources, Government of India, National Water Development Agency and Central Water Commission. <http://www.source.irc.nl/page/75479>

World Water Summit V on 21 June 2013; Lisbon, Portugal. Organised by: Water & Sanitation Rotarian Action group (Wasrag). <http://www.source.irc.nl/page/76200>

3rd International Water Association (IWA) Development Congress & Exhibition on 14-17 October 2013; Nairobi, Kenya. Organised by: (IWA), Water Services Providers Association (WASPA) and Nairobi City Water and Sewerage Company (NCWSC). <http://www.source.irc.nl/page/75967>

**Selected WOCAT case studies:**

Botswana. Roof rainwater harvesting system. QTBOT04. [http://cdewocat.unibe.ch/wocatQT/qt\\_summary.php?lang=English&qt\\_id=105](http://cdewocat.unibe.ch/wocatQT/qt_summary.php?lang=English&qt_id=105)

Nepal: Rooftop rainwater harvesting system. QTNEP18. [http://cdewocat.unibe.ch/wocatQT/qt\\_summary.php?lang=English&qt\\_id=499](http://cdewocat.unibe.ch/wocatQT/qt_summary.php?lang=English&qt_id=499)

Tajikistan: Roof top rainwater harvesting stored in a polythene lined earth retention tank. QTTAJ104. [http://cdewocat.unibe.ch/wocatQT/qt\\_summary.php?lang=English&qt\\_id=298](http://cdewocat.unibe.ch/wocatQT/qt_summary.php?lang=English&qt_id=298)

Tajikistan: Roof top rainwater harvesting: concrete tank. QTTAJ348. [http://cdewocat.unibe.ch/wocatQT/qt\\_summary.php?lang=English&qt\\_id=348](http://cdewocat.unibe.ch/wocatQT/qt_summary.php?lang=English&qt_id=348)





## Roof rainwater harvesting system

Botswana – Lekidi (Setswana)

### Roof rainwater catchment system using galvanised iron roof material, feeding an underground water tank.

A roof of galvanised iron (corrugated iron) with the dimensions 7 x 6m is constructed on a support of gum poles (see photos). The roof catches the rain. The rain water flows over the roof into pipes at the rear end of the roof (sloping side) into an underground conical water tank. The tank is made of bricks and mortar. The underground tank serves two key roles: i) it stores water for use during the dry spells or times of no rain; and ii) the tank keeps the water cool in this hot environment. The technology is most preferred for so-called 'lands' areas, to provide household drinking water. On average, these lands are distant from water sources (e.g. 2-15 km). Other benefits of storing rainwater include less pressure on natural water ponds, but this would be a secondary concern.

Water is critical for human consumption and needed around the home. The cool water is effective in quenching the thirst; it reduces labour time to collect water thus freeing time to concentrate on other farm activities. The water is mainly for household drinking and household chores like washing. Some is used as drinking water for chickens and for the animals used for draught power (e.g. donkeys during ploughing). The units are for use by individual farmers and thus restricted to individual households. The owner or the farmer has exclusive rights to the use of the water. Some farmers indicated that, in times of no rain, or before the first rains, they collect water from the village in drums, and pour it into this underground water tank, thus using it as a reservoir. They especially like the persistent coolness of water stored in the underground tank.

The technology is for rainwater collection in four villages. Rainwater that flows over the roof is collected, for example, on galvanised iron roofs. The water then runs through gutters and a pipe to the underground water tank. To build the underground tank, the ground is excavated, to about 2m deep and about 3m wide. Within this hole, a drum-like feature is built with concrete bricks and mortar. After the wall of the tank is complete, it is then lined with mortar from the inside, and the base is also lined to form the completed tank. It is then sealed at over most of the surface leaving an opening with a lid. This opening is large enough for a man to enter for occasional cleaning of the groundwater tank. Thus the system comprises a roof, for collecting rainwater, and an underground tank for storing it.

The environment is semi-arid and seasonal rainfall dominates during the summer months of October to April. People depend on nearby boreholes for water in the lands areas or have to travel to the village (about 2-5km away on average, but can be up to 15km) to fetch water. Most boreholes are either privately owned or communal and water is rationed to about two drums per week or even fortnightly. Most of the borehole water in the area is brackish. Thus roof rainwater (which is fresh) acts as the preferred alternative source of water. The underground tank, once full, is equivalent to 110 drums. Most normal rain events fill the tank, and the water remains in use till the next rainy season, which was found to be the case at all four pilot sites visited. Thus the rainwater catchments systems offer water security in the lands areas; water of very good drinking quality (sweet taste, cooler).

**Above left:** View of roof rainwater system at the lands in Mokoboxhane. (Photo: L. Magole)  
**Above right:** Taking dimensions for a rainwater system in Mopipi lands. (Photo: M. Moemedi)

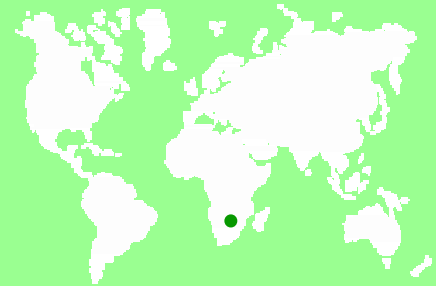





**Location:** Boteti area, in the Central District of Botswana  
**Region:** Central District  
**Technology area:** 0.01 km<sup>2</sup>  
**Conservation measure:** structural  
**Stage of intervention:** mitigation / reduction of land degradation  
**Origin:** developed externally / introduced through project, 10-50 years ago  
**Land use:** cropland and grazing land  
**Climate:** semi-arid, subtropics  
**WOCAT database reference:** QT BOT004en on [cdewocat.unibe.ch/wocatQT](http://cdewocat.unibe.ch/wocatQT)  
**Related approach:** not documented  
**Compiled by:** Julius Athopheng, University of Botswana  
**Date:** 18th Mar 2009, updated 3rd Jun 2011



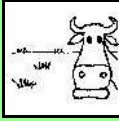

## Classification

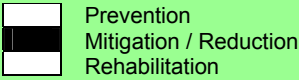
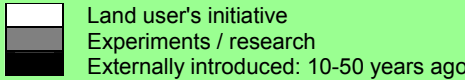
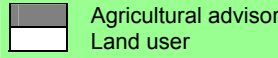
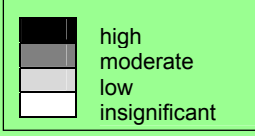
**Land use problems:** Water shortage and poor water quality. The water harvesting system is critical in a semi-arid environment, where water shortages are common. To augment water supplies, storage is needed especially in arable land areas where there are no coordinated water distributions like standpipes, as is the case in villages. People at the lands eke a living out of the arable fields, and assured water availability enables families to remain longer close to the fields for essential crop management, hence increased yields.

Land use	Climate	Degradation	Conservation measure
 annual cropping  extensive grazing land	 semi-arid, subtropics	 water degradation: change in groundwater / aquifer level	 structural: dams / pans: (to store excessive water)
<b>Stage of intervention</b> 	<b>Origin</b> 	<b>Level of technical knowledge</b> 	
<b>Main causes of land degradation:</b> Direct causes - natural: droughts Indirect causes: land tenure		<b>Main technical functions:</b> - water harvesting / increase water supply	
		<b>Secondary technical functions:</b> - is used as open storage for farm equipment - offers shade against the heat, as well as temporary shelter	
			

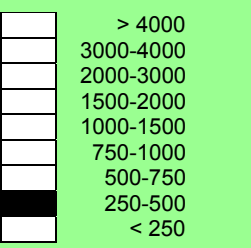
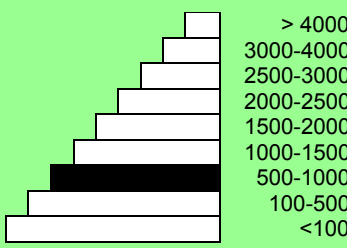
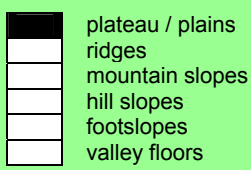
## Environment

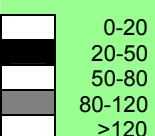
Natural Environment	Altitude (m a.s.l.)	Landform	Slope (%)
<b>Average annual rainfall (mm)</b> 			
<b>Soil depth (cm)</b> 	<b>Growing season(s):</b> 197 days (October - March) <b>Soil texture:</b> coarse / light (sandy) <b>Soil fertility:</b> very low <b>Topsoil organic matter:</b> low (<1%) <b>Soil drainage/infiltration:</b> good		<b>Soil water storage capacity:</b> very low <b>Ground water table:</b> 5 - 50 m <b>Availability of surface water:</b> poor / none <b>Water quality:</b> poor drinking water <b>Biodiversity:</b> high medium
<b>Tolerant of climatic extremes:</b> temperature increase, seasonal rainfall increase, heavy rainfall (intensities and amount), floods, decreasing length of growing season. <b>Sensitive to climatic extremes:</b> seasonal rainfall decrease, droughts / dry spells <b>If sensitive, what modifications were made / are possible:</b> The roof area is such that, some limited amounts of rain do fill or add some water into the storage tank.			

## Human Environment

### Cropland per household (ha)

	<0.5
	0.5-1
	1-2
	2-5
	5-15
	15-50
	50-100
	100-500
	500-1,000
	1,000-10,000
	>10,000

**Land user:** individual, small scale land users and disadvantaged land users  
**Population density:** < 10 persons/km<sup>2</sup>  
**Annual population growth:** 2% - 3%  
**Land ownership:** communal / village  
**Land use rights:** open access (unorganised)  
 (Communal grazing and individual land ownership for ploughing. Water availed through communal boreholes in lands and cattle posts, but with individual standpipes in villages. Open access to surface water resources for livestock e.g. pans after rains. Dual grazing rights problem, whereby private ranchers graze in the commons, but the opposite not possible.)  
**Water use rights:** communal (organised) (Communal grazing and individual land ownership for ploughing. Water availed through communal boreholes in lands and cattle posts, but with individual standpipes in villages.)

Open access to surface water resources for livestock e.g. pans after rains. Dual grazing rights problem, whereby private ranchers graze in the commons, but the opposite not possible.)  
**Relative level of wealth:** very poor, which represent 30%; 20% of the total land area is owned by very poor land users  
**Importance of off-farm income:** less than 10% of all income: Saves labour time to fetch water. Very limited off-farm income opportunities for everyone, including non-adopters of the technology  
**Access to service and infrastructure:** low: employment, energy, financial services; moderate: health, education, technical assistance, market, roads & transport, drinking water and sanitation  
**Market orientation:** subsistence (self-supply)

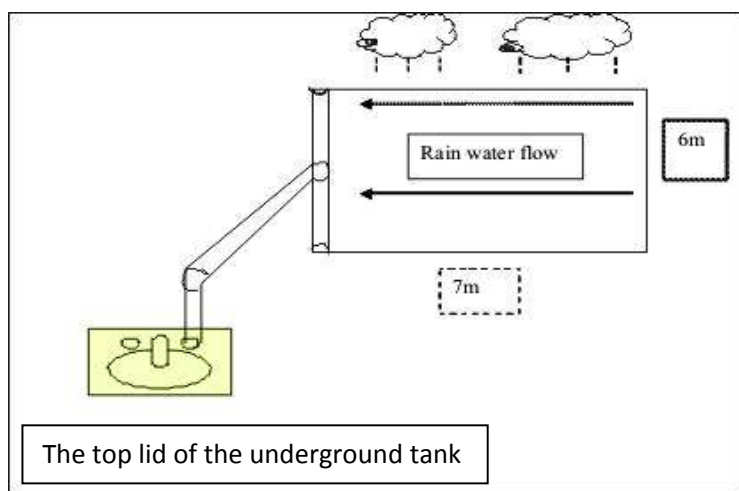

### Technical drawing

Rain water falls onto the corrugated roof surface, which usually measures 7 x 6m. This water flows down into the gutters, then down through the pipe into an underground water storage tank (built from concrete blocks which are lined with a coating of mortar, or mortar is applied to wire mesh. Most storage tanks, when full, have a capacity of about 110 drums (a drum holds 200 litres). Without this system, a farmer usually only has about 2 drums per week. (Athlopheng Julius).

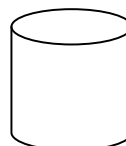

Circular underground tank

## Implementation activities, inputs and costs

### Establishment activities

1. Digging pit
2. Transporting sand, cement and concrete blocks
3. Construction

### Establishment inputs and costs per unit

Inputs	Costs (US\$ / local currency)	% met by land user
Labour	12.5	100
Construction material - sand, cement, concrete block	1'500	100
Other - labour by government person (8 person days)	500	0
<b>TOTAL</b>	<b>2'012.5</b>	<b>75</b>

### Maintenance/recurrent activities

1. Cleaning roof
2. Cleaning storage tank

### Maintenance/recurrent inputs and costs per unit per year

Inputs	Costs (US\$ / local currency)	% met by land user
Labour	12.5	100
<b>TOTAL</b>	<b>12.5</b>	<b>100</b>

**Remarks:** Cost of building materials, specifically iron sheets, timber, concrete blocks, cement and the professional builder from the government. Prices of construction material for the roof rainwater system, fitted with the underground water storage system. All prices and exchange rates were calculated for 29 September 2008. The government subsidy was such that, men pay 30% of all costs, while women pay 20%. The 20-30% could be paid through labour (i.e. digging the pit, transporting sand and cement and serving as a labour hand during construction. Thus if the farmer offers labour, then he does not pay anything. The costs are calculated with labour input and its price or the local wage, which is 5 US\$ per day. Each roof catchment unit is supposed to benefit one household, so it serves on average 4 people, who farm a 2-3 ha area (5-15km away from the main village).

## Assessment

### Impacts of the Technology

#### Production and socio-economic benefits

- +++ reduced risk of production failure
- +++ increased drinking water availability
- ++ increased crop yield
- ++ diversification of income sources
- ++ decreased workload
- + increased animal production

#### Production and socio-economic disadvantages

- +++ increased expenses on agricultural inputs
- +++ increased economic inequity

#### Socio-cultural benefits

- +++ improved health
- +++ conflict mitigation
- ++ community institution strengthening
- ++ improved situation of disadvantaged groups
- ++ improved food security / self-sufficiency

#### Socio-cultural disadvantages

- +++ worsen situation of disadvantaged groups

#### Ecological benefits

- +++ increased water quantity and quality
- +++ improved harvesting / collection of water
- +++ reduced evaporation
- +++ reduced emission of carbon and greenhouse gases

#### Ecological disadvantages

- ++ decreased water quality (if roof not cleaned)

#### Off-site benefits

- + increased water availability

#### Off-site disadvantages

none

#### Contribution to human well-being/livelihoods

++ Many educational tours made on these demonstration sites. Fresh rainwater is good for health compared to borehole (salty) water.

+++: high, ++: medium, +: low

#### Benefits/costs according to land user

Benefits compared with costs	short-term:	long-term:
<b>Establishment</b>	very negative	very positive
<b>Maintenance/recurrent</b>	very negative	very positive

Very costly to set up, if no government aid. It is however, very good for long term water provision.

**Acceptance/adoption:** The technology is generally deemed to be too expensive by the less wealthy farmers; and inadequate for the rich farmers (need to water many cattle) who drill their own boreholes. Thus only about 1% of land user families (1 families; 1% of area) have implemented the technology with external material support. There is one such structure per village in Boteti sub-district - and they are all demonstration schemes. There was no public uptake following demonstration, as government subsidy changed and was later stopped. It is too costly e.g. building materials, hiring of professional builder and cement to set up in lands areas. There is no trend towards (growing) spontaneous adoption of the technology. High capital or start-up costs. The area has low income groups who get water from communal boreholes, while rich cattle owners obtain water from their private boreholes, and hence desalination is favoured rather than rainwater systems.

## Concluding statements

#### Strengths and → how to sustain/improve

- Provides cool water in hot summers → keep it working.
- Provides water in *lands* areas, where it is most needed → maintain the structure, or increase tank capacity.
- Farmers appreciate the good water quality and clean system annually → keep it working.
- It has low maintenance costs, it is easy to use → keep it working.
- Useful as shelter or storage → keep it working.

#### Weaknesses and → how to overcome

- Costly to set up → subsidies by government, NGOs, private sector.
- Seen as dependent on rains, thus fails during droughts → research, information dissemination to stakeholders.
- Water quality issues (concerns) → education on keeping storage clean and boiling water for human consumption.
- Costly to set up, due to the price of building materials → government subsidies, private sector, NGOs.
- Fear that their land would be taken away by the government after financial assistance → education on subsidies to allay fears.

**Key reference(s):** Ministry of Agriculture Headquarters, Department of Crop Production, Engineering Division, Water Development Section, P/Bag 003, Gaborone, Botswana. dcp@gov.bw [department of crop production] or kmphokedi@gov.bw [for director] and [blaolalng@gov.bw] for technical officer  
**Contact person(s):** Julius Athlhopeng, University of Botswana. ATLHOPHE@mopipi.ub.edu



## Rooftop rainwater harvesting system

Nepal - Akase paani sankalan pranali (Nepali)

**A water harvesting system in which rain falling on a roof is led through connecting pipes into a ferro-cement water collecting jar.**

Many households in Nepal's midhills suffer from water shortages during the pronounced dry season. The technology described here - harvesting roofwater during times of heavy rainfall for later use - is a promising way of improving people's access to water for household use, especially for households with no or only limited access to spring or stream water. The technology has yet to be extensively adopted in Nepal's midhills.

The technology was introduced in the Jhikhu Khola watershed to demonstrate an alternative source of water for domestic use (mainly drinking water). This technology is appropriate for scattered rural households in mountainous areas. The harvesting system consists of a catchment roof, conveyance pipes, and a storage jar. The pipes include a gutter system made from longitudinally split polythene pipe which has a flushing system that allows the system to be periodically flushed clean. The collected water enters a 500 or 2000 litre capacity ferro-cement jar made using a mould (see photo). A pre-constructed mould made from iron rods and polythene pipes is installed on a concrete base plate. Metal wires are extended from the base plate over the main mould to the top. Chicken mesh is then wrapped over the mould and tied securely with thin wire. A cement coating is applied over the metal structure. The jar is finished with three coatings of cement and the opening is covered with a fine nylon mesh to filter out undesired coarse matter. A tin lid is placed over the top.

A tap is fixed about 20 cm above the ground. This height allows for water to be collected in the typical 15 litre local water vessels (*gagri*) and avoids collection of too much water in bigger vessels as well as minimising the dead storage of water (Nakarmi et al. 2003). Trained masons can easily install the entire system. Provided all the materials and the mould are available, the entire system can be put together in about a week. The main maintenance task is to keep the roof clean, especially after long dry periods. This is done using the gutter pipe flushing system in which the first dirty water from the roof is diverted away from the jar.

**Above left:** The three components of a roof rainwater harvesting system: a catchment roof, conveyance pipes, and a ferro-cement storage jar. (Photo: K.M. Sthapit)

**Above right:** Installing the mould and wrapping it in chicken mesh to make the jar. (Photo: PARDYP)

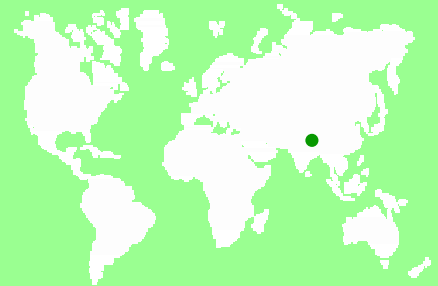

**Location:** Kharelthok, Sathighar, Panchkhal, Hokse and Patalekhet VDCs of the Jhikhu Khola watershed

**Region:** Kavrepalanchowk district

**Technology area:** 1 - 10 km<sup>2</sup>

**Conservation measure:** structural

**Stage of intervention:** mitigation

**Origin:** developed externally / introduced through project, recent, < 10 years ago

**Land use:** settlements, infrastructure networks

**Climate:** semi-arid, subtropics

**WOCAT database reference:** QT NEP018en

on cdewocat.unibe.ch/wocatQT

**Related approach:** not documented

**Compiled by:** Madhav Dhakal, ICIMOD, Nepal



**Date:** 20th Oct 2006, updated 2008

ICIMOD

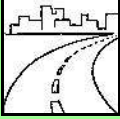
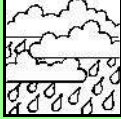

## Classification

**Land use problems:** Inadequate water supply during the late winter and pre-monsoon months and sediment contamination during the wet season. The discharge from traditional water sources like dug-out ponds, springs, seepage 'holes', shallow wells, and streamlets becomes limited soon after the end of the monsoon. Many settlements are located on ridge tops and most water sources are located below making it difficult to provide water to households through networks of pipes. Women and girls often face hardship in carrying the water uphill, especially during the monsoon when trails are slippery.

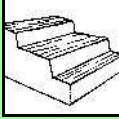
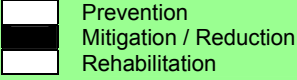
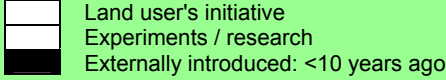
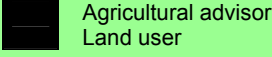
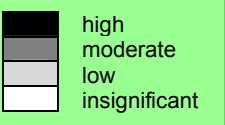
Land use	Climate	Degradation	Conservation measure
 settlements, infrastructure networks	 humid, subtropics	 physical degradation: water scarcity	 structural: tank or jar
Stage of intervention	Origin	Level of technical knowledge	
			
<b>Main causes of land degradation:</b> Direct causes - natural: change of seasonal rainfall			
<b>Main technical functions:</b> - water harvesting / increase water supply		<b>Secondary technical functions:</b> none	
			

## Environment

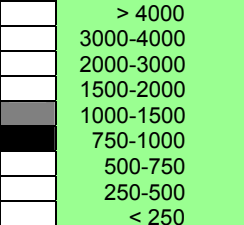
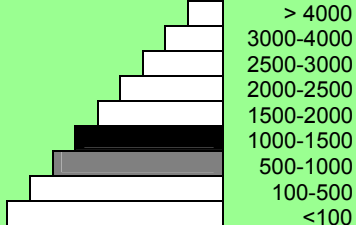
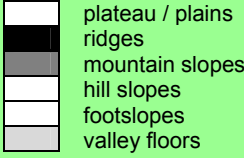
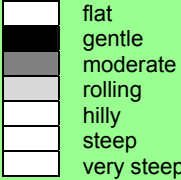
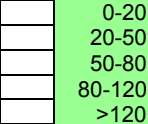
Natural Environment			
Average annual rainfall (mm)	Altitude (m a.s.l.)	Landform	Slope (%)
			
<b>Soil depth (cm):</b> n/ap* 	<b>Growing season(s):</b> 150 days (June - October) <b>Soil texture:</b> n/ap <b>Soil fertility:</b> n/ap <b>Topsoil organic matter:</b> n/ap <b>Soil drainage/infiltration:</b> n/ap		<b>Soil water storage capacity:</b> n/ap <b>Ground water table:</b> n/ap <b>Availability of surface water:</b> n/ap <b>Water quality:</b> poor drinking water <b>Biodiversity:</b> n/ap
<b>Tolerant of climatic extremes:</b> temperature increase, seasonal rainfall increase, heavy rainfall events (intensities and amount), wind storms / dust storms, floods, decreasing length of growing period <b>Sensitive to climatic extremes:</b> seasonal rainfall decrease, droughts / dry spells <b>If sensitive, what modifications were made / are possible:</b> no data			
* n/ap: not applicable			

## Human Environment

### Cropland per household (ha)

	<0.5
	0.5-1
	1-2
	2-5
	5-15
	15-50
	50-100
	100-500
	500-1,000
	1,000-10,000
	>10,000

**Land user:** individual / household, medium scale land users, common / average land users, men and women

**Population density:** 200-500 persons/km<sup>2</sup>

**Annual population growth:** 2 - 3%

**Land ownership:** individual, titled

**Land use rights:** individual

**Water use rights:** communal (organised)

**Relative level of wealth** poor, which represents 50% of land users; 25% of the total land area is owned by average land users

**Importance of off-farm income:** 10-50% of all income: In most farm households off-farm income plays at least a minor and increasingly a major role. Occasional opportunities for off-farm income present themselves in the form of daily

**Access to service and infrastructure:**

**Market orientation:** subsistence (self-supply)

**Mechanization:** no data

**Livestock grazing on crop residues:** 3.9 tropical livestock units (TLU) per household

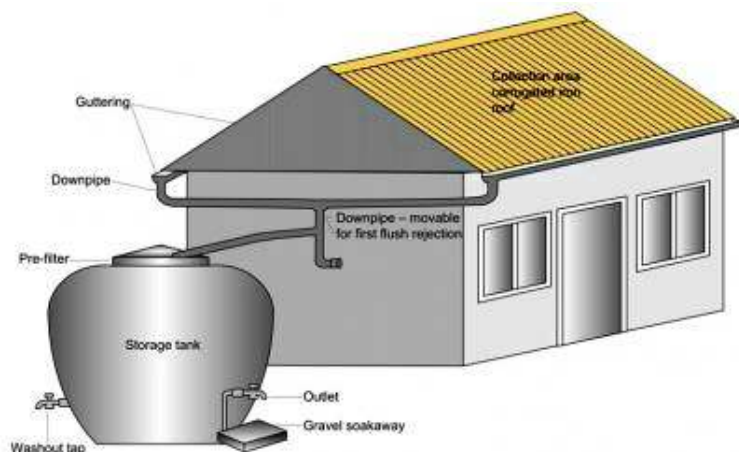

### Technical drawing

A water harvesting system with roof catchment, connecting pipes and storage tank. (A.K. Thaku)

## Implementation activities, inputs and costs

### Establishment activities

1. Construct the concrete base plate with the help of base mould
2. Curing work
3. Final checking and metal cap putting over the top of the jar
4. First coat of cement
5. Gutter and pipe fitting; including flush pipe
6. Inner coat of cement
7. Main mould installation with the help of metal wires, wrapping of chicken mesh
8. Removal of mould
9. Second coat of cement

### Establishment inputs and costs per ha

Inputs	Costs (US\$)	% met by land user
Labour (15 person days)	41.1	25
Construction material		
- cement (4kg)	23.6	
- sand and aggregate	1.4	100
- chicken wire mesh (m)	20.9	
- metal jar cover	5.5	
- plastic sheet and mosquito screen	1.5	
- paint	2.1	
- high density polyethylene, pipes, reducer	23.7	
- nail, clamps, pipe elbow, tee connector, end cap	3.6	
- nipples, brass tap, galvanized iron, socket, thread seal tap	3.5	
<b>TOTAL</b>	<b>127</b>	<b>9</b>

### Maintenance/recurrent activities

1. Cleaning the jar once or twice a year
2. Flushing contaminated water

### Maintenance/recurrent inputs and costs per ha per year

Inputs	Costs (US\$)	% met by land user
Labour	15	100
<b>TOTAL</b>	<b>15</b>	<b>100</b>

**Remarks:** The mould and tools were provided by the project and can be used to install many water harvesting systems. Therefore the cost of tools is not included here. Material costs fluctuate from time to time. The transport costs will vary according to the remoteness of the site. During 1999/2000, the cost of a system varied from US\$80 to US\$120, of which land users contributed about US\$40 by providing the unskilled labour and locally available materials like sand and fine aggregates (calculated at an exchange rate of US\$1 = NRs 73).

## Assessment

Impacts of the Technology	
<b>Production and socio-economic benefits</b> none	<b>Production and socio-economic disadvantages</b> + ■ ■ loss of land (place to accommodate the water jar)
<b>Socio-cultural benefits</b> +++ community institution strengthening +++ improved conservation / erosion knowledge	<b>Socio-cultural disadvantages</b> none
<b>Ecological benefits</b> ++ increased water availability in dry season ++ better sanitation	<b>Ecological disadvantages</b> none
<b>Off-site benefits</b> ++ increased availability of water for neighbours during scarce period	<b>Off-site disadvantages</b> none
<b>Contribution to human well-being/livelihoods</b> + ■ ■ improved health condition due to clean water availability.	

+++ : high, ++ : medium, + : low

Benefits/costs according to land user	Benefits compared with costs	
	short-term:	long-term:
	<b>Establishment</b>	slightly negative
<b>Maintenance/recurrent</b>	very positive	very positive

Although the initial investment is high, the users immediately get more water. The high cost of installing the system means that the short term benefits are slightly negative.

**Acceptance/adoption:** 74% of land user families have implemented the technology with external material support. 26% of land user families have implemented the technology voluntary. There is little trend towards (growing) spontaneous adoption of the technology. The number of households applying the technology is increasing without further incentives being provided.

## Concluding statements

### Strengths and → how to sustain/improve

Harvested rainwater has saved almost one workday per day per family due to reduced water fetching time in this case referring to the rainy season, however water will generally be used during the dry season → publicise the economic benefits of the technology through experience sharing programs.

Women are responsible for fetching water and so the technology reduces their workloads → implement a larger scale program to promote the technology.

The jars are more durable than plastic tanks → carry out regular maintenance to keep systems in good working order.

The stored water can be kept for use in emergencies such as to prepare food for guests during busy times like rice planting and harvesting, and during festivals → share experiences to extend adoption of the technology.

Harvested water is tastier due to being cooler compared to the water collected in the polythene tank. → laboratory analysis of the harvested rainwater in different time period, i.e. from 1st month of harvest to 12th month could help to know the quality status.

### Weaknesses and → how to overcome

2,000 litre capacity jars barely meet the dry season needs of a household → larger sized jars or more than one jar need to be built to meet most household's requirements.

Microbiological contamination (total and faecal coliform bacteria) and levels of phosphate above the EC maximum were found in a number of the jars caused by bird droppings and dust particles from the roof → regularly clean catchment roofs and treat water before drinking by boiling or chlorinating. Rainwater has a low mineral content which can be harmful for the human body, if taken in large quantities (due to reverse osmosis process).

This technology is not suitable for temple roofs because such roofs are usually home to large numbers of pigeons, and their excreta will contaminate rainwater that falls there → avoid badly contaminated catchments.

The technology is expensive for poor households → external support is needed for poor households to afford this system.

The height of the tap is very low which makes it inconvenient to collect water in the *gagree* → it was designed to use collected water efficiently, the tap height can be raised, which means that the dead storage is increased, i.e. more water is unavailable for use.

There are chances of the jar's base plate subsiding due to lack of compactness of foundation → the area of base plate should be made more compact.

**Key reference(s):** Harma, C. (2001) Socioeconomic Indicative Impact Assessment and Benchmark Study on Rooftop Rainwater Harvesting, Kabhrepalanchok District, Nepal, a report submitted to ICIMOD, Kathmandu, Nepal / ICIMOD (2000) Water Harvesting Manual, unpublished manual prepared for PARDYP Project, ICIMOD / ICIMOD (2007) Good Practices in Watershed Management, Lessons Learned in the Mid Hills of Nepal. Kathmandu: ICIMOD / Lessons Learned from the People and Resource Dynamics Project, PARDYP/ICIMOD. 2006. / Nakarmi, G.; Merz, J.; Dhakal, M. (2003) 'Harvesting Roof Water for Livelihood Improvement: A Case Study of the Yarsha Khola Watershed, Eastern Nepal'. In News Bulletin of Nepal Geological Society, 20: 83-87 / Nakarmi, G.; Merz, J. (2001) Harvesting Rain Water for Sustainable Water Supplies to Rural Households in the Yarsha Khola Watershed, a report submitted to Kirchgemeinde Zuoz, Switzerland and ICIMOD, Kathmandu, Nepal

**Contact person(s):** Madhav Dhakal, ICIMOD, Kathmandu, Nepal. mdhakal@icimod.org



## Roof top rainwater harvesting stored in a polyethylene lined earth retention tank

Tajikistan - Чамъоварии оби борон аз руи боми хона (Russian)

**The use of an earth tank lined with a polyethylene sheet to retain rainwater collected from the roof of the house.**

An earth retention tank is a simple low cost structure that can be used to retain rain water from the rooftop. A hole is prepared and lined with a polyethylene sheet to prevent leakage. The top of the hole is covered with a metal lid for access. The roof of the house is fitted with a plastic guttering that captures the rainwater and funnels the water via a plastic pipe into the earth tank. The water in the earth tank then can be utilised for the irrigation of crops (especially during the hot dry summer months), sanitation, and potentially drinking water.

The population in Southern Tajikistan consists largely of subsistence farmers and are thus highly reliant upon their kitchen garden plots. As the population in the area continues to expand, the pressure on the land increases. The latter is already in a poor state, because it is becoming degraded through deforestation, overgrazing and general over exploitation. There is much precipitation during the rainy season from autumn until spring in Southern Tajikistan, but the scarcity of water from late spring to the end of autumn poses a problem with water shortages. During the rainy season, a lot of water is lost as surface runoff, this water can be saved in a retention tank to be utilised during the dry season. It can be used to water crops to help increase yields as well as crop diversity and quality. The additional water can also be used for sanitation, drinking water and watering of livestock.

For the establishment of such a retention tank several steps are needed. In preparation, a rough estimation of the potential volume of harvested rainwater needs to be calculated. Thereafter, a location for the tank needs to be selected so that expenses are minimised and it is easy to access. The establishment of ponds near big trees is not recommended, because the polyethylene layer might be punctured by the roots.

The actual steps of constructing the tank involve: (1) digging the pond, (2) plastering the inside walls with a fine soil and water mixture to smooth them, (3) lining the pond's walls with double polyethylene layer, (4) connecting the inside polyethylene sheets with the pond coverage through a piece of cord, so that it can be taken out of the pond any time to be cleaned of sediments, (5) covering the pond with any available material such as a soil, water and straw mixture, reinforced by several poles, leaving an opening of 0.25 x 0.25m to extract water, (6) finally connecting the roof to the pond with a plastic pipe. To avoid dirty water flowing from the roof into the pond, the pipe should only be connected to the pond sometime after the rainfall has started.

**Above left:** low cost rainwater harvesting tank connected to the gutter with a pipe. (Photo: Daler Domullojonov)

**Above right:** low cost rainwater harvesting tank. (Photo: Daler Domullojonov)

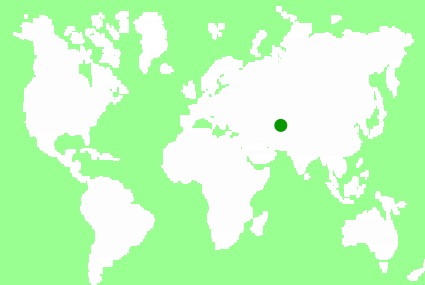

**Location:** Temurmaliq, Baljuvon

**Region:** Khatlon province

**Technology area:** 10 - 100 km<sup>2</sup>

**Conservation measure:** structural

**Stage of intervention:** rehabilitation / reclamation of denuded land

**Origin:** developed externally / introduced through project, recent (<10 years ago)

**Land use:** settlements, infrastructure networks

**Climate:** semi-arid, temperate

**WOCAT database reference:** QT TAJ104en on cdewocat.unibe.ch/wocatQT

**Related approach:** not documented



**Compiled by:** Daler Domullojonov, Welthungerhilfe

**Date:** 06th Apr 2011, updated 08th Jul 2011

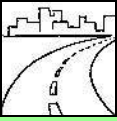

## Classification

**Land use problems:** The lack of water and inefficient natural resource management, which is mainly visual because people throw potential organic fertilizers away instead of spreading them on the fields. Incorrect ploughing techniques which leads to the acceleration of erosion, deforestation and waste of fuel materials in inefficient stoves and ovens. Overgrazing leading to pasture degradation.

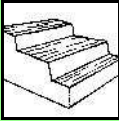
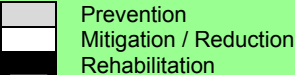
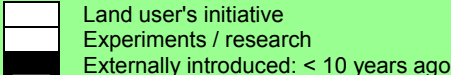
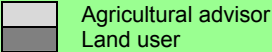
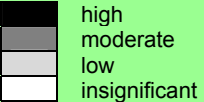
<p><b>Land use</b></p>  <p>settlements, infrastructure networks</p>	<p><b>Climate</b></p>  <p>semi-arid, temperate</p>	<p><b>Degradation</b></p>  <p>water degradation: aridification, change in quantity of surface water, decline of surface water quality</p>	<p><b>Conservation measure</b></p>  <p>structural: dams / pans (to store excessive water)</p>
<p><b>Stage of intervention</b></p> 	<p><b>Origin</b></p> 	<p><b>Level of technical knowledge</b></p> 	
<p><b>Main causes of land degradation:</b>          Direct causes - human induced: soil management, deforestation / removal of natural vegetation (incl. forest fires), overgrazing          Indirect causes: inputs and infrastructure</p>			
<p><b>Main technical functions:</b></p> <ul style="list-style-type: none"> <li>- water harvesting / increase water supply</li> <li>- control of concentrated runoff: retain / trap</li> <li>- control of concentrated runoff: drain / divert</li> </ul>	<p><b>Secondary technical functions:</b> no data</p>		

## Environment

### Natural Environment

#### Average annual rainfall (mm)

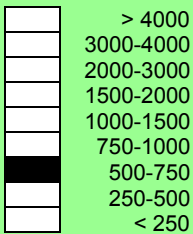

#### Altitude (m a.s.l.)

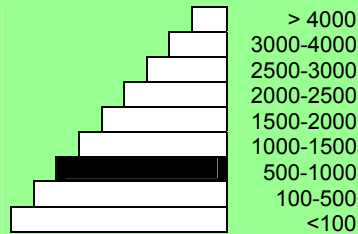

#### Landform

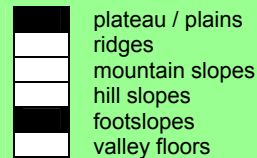

#### Slope (%)

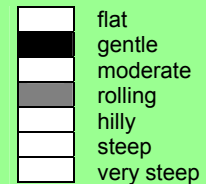

#### Soil depth (cm)

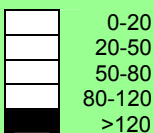

**Growing season(s):** 180 days (March until November)  
**Soil texture:** fine / heavy (clay)  
**Soil fertility:** medium  
**Topsoil organic matter:** low (<1%)  
**Soil drainage/infiltration:** medium

**Soil water storage capacity:** medium  
**Ground water table:** 5 - 50 m  
**Availability of surface water:** poor / none  
**Water quality:** poor drinking water  
**Biodiversity:** low

**Tolerant of climatic extremes:** temperature increase, seasonal rainfall increase, heavy rainfall events (intensities and amount), wind storms / dust storms, decreasing length of growing period

**Sensitive to climatic extremes:** seasonal rainfall decrease, floods, droughts / dry spells

**If sensitive, what modifications were made / are possible:** To minimise the damage to the polyethylene waterproofing layers and, reduce evaporation rates, pond is covered. As the pond is dug into earth the temperature remains fairly stable. If precipitation decreases less water can be harvested.

## Human Environment

### Cropland per household (ha)

no data
<0.5
0.5-1
1-2
2-5
5-15
15-50
50-100
100-500
500-1,000
1,000-10,000
>10,000

**Land user:** individual / household, small scale land users, common / average land users, men and women

**Population density:** < 10 persons/km<sup>2</sup>

**Annual population growth:** 1% - 2%

**Land ownership:** state, individual, titled

**Land use rights:** individual

**Water use rights:** individual

**Relative level of wealth:** poor, which represents 100% of land users.

**Importance of off-farm income:** 10-50% of all income: In this example the farmer's son has migrated to Russia.

**Access to service and infrastructure:** low: health, technical assistance, employment (eg off-farm), market, energy, roads & transport, drinking water and sanitation, financial services; moderate: education

**Market orientation:** n/ap\*

**Mechanization:** n/ap

**Livestock grazing on crop residues:** n/ap

\*n/ap: not applicable

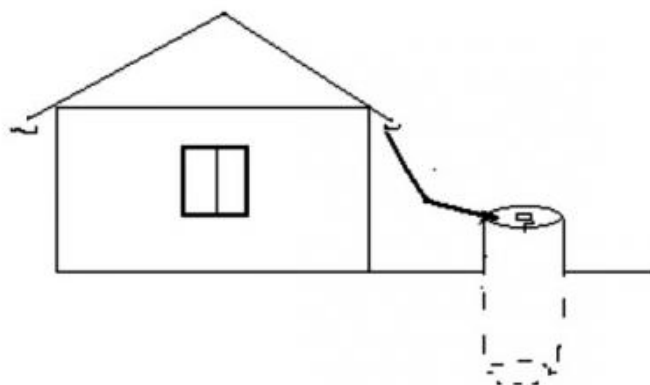

### Technical drawing

Harvesting water from the household roof to an earth built retention pond with plastic sheet lining. The retention pond is covered with a removable metal plate for access. (Daler Domullojonov)

## Implementation activities, inputs and costs

### Establishment activities

1. Manual digging of pond, smoothing and plastering, covering pond
2. Polyethylene sheet and pipe procurement, preparation and placement

### Establishment inputs and costs per ha

Inputs	Costs (US\$)	% met by land user
Labour	13.8	100
Equipment		
- bucket	1	100
Construction material		
- wood	4.4	100
- earth	1	100
- polyethylene sheet	5.1	50
- plastic pipe	2.2	100
- cord	0.11	50
<b>TOTAL</b>	<b>27.6</b>	<b>86</b>

### Maintenance/recurrent activities

1. Changing polyethylene sheet; covering
2. Cleaning of pond (washing out sediments)

### Maintenance/recurrent inputs and costs per ha per year

Inputs	Costs (US\$)	% met by land user
Labour	1	100
Construction material		
- earth	0.6	
- polyethylene sheet	5.1	100
- cord	2.2	
<b>TOTAL</b>	<b>8.9</b>	<b>100</b>

**Remarks:** The type of earth in Tajikistan is very good for making the retention ponds, the labour is provided by the land user, and the plastic pipes can be manufactured out of empty plastic bottles. The polythene sheet and cord have to be purchased from the shop. The above costs were calculated for the building of one retention tank. One household could have several ponds in one kitchen garden.

## Assessment

### Impacts of the Technology

<b>Production and socio-economic benefits</b> +++ increased water availability / quality ++ increased irrigation water availability quality ++ increased farm income ++ decreased workload + increased crop yield + increased fodder production + increased animal production	<b>Production and socio-economic disadvantages</b> none
<b>Socio-cultural benefits</b> ++ improved food security / self sufficiency	<b>Socio-cultural disadvantages</b> none
<b>Ecological benefits</b> +++ increased water quantity +++ improved harvesting / collection of water + reduced surface runoff	<b>Ecological disadvantages</b> none
<b>Off-site benefits</b> none	<b>Off-site disadvantages</b> none
<b>Contribution to human well-being/livelihoods</b> ++ Much more water is readily available for use by the household. Less time and effort is spent carrying water.	

+++: high, ++: medium, +: low

Benefits/costs according to land user	Benefits compared with costs	
	short-term:	long-term:
<b>Establishment</b>	very positive	not specified
<b>Maintenance/recurrent</b>	very positive	not specified

Before the implementation of this technology, one family would spend an average of \$44.5 on one truck of water per month. A pond costs around \$25 to build, and should provide families with around 4 months' worth of water after the rainy season.

**Acceptance/adoption:** 58% of land user families have implemented the technology with external material support. In the initial stages of the project, they were provided with 50% of the costs of the polyethylene sheets and cord only. 42% of land user families have implemented the technology voluntary. After observing the benefits of the technology and the high cost benefit ratio, many people in the community and surrounding villages have replicated this technology themselves. There is strong trend towards (growing) spontaneous adoption of the technology.

### Concluding statements

Strengths and → how to sustain/improve	Weaknesses and → how to overcome
It is a low cost technology and can be made from many locally available materials → to disseminate these ideas in areas with water scarcity through local Extension Service providers / NGOs or local inhabitants.	The plastic layers have a limited lifespan → to find thicker and hardier materials, or apply multiple layers.
It reduces the time and effort to collect water and also the cost to buy water → promotion of different water saving methods and technologies by interested and line departments.	The waterproof layer can easily be degraded by mice and large insects.
More water available for gardening and household purposes.	Farmers consider it relatively expensive to implement and there is no guarantee for water as this depends on the rainfall events → subsidies might help to install these structures where feasible. Therefore, good assessments of expected water inflow volumes are required before construction.
Increases access to water for drinking and sanitation purposes → construction of larger and/or more tanks.	The polyethylene only lasts for 2-4 years → to increase the number of layers or use a thicker polyethylene sheet.
Provides water for irrigation during the hot dry months, therefore improving crop diversity and yields → training and education on kitchen garden farming techniques to optimise the use of the extra water supply.	
Easy and quick to establish, and maintain.	

**Key reference(s):** Brochure - Converting drought prone areas into productive gardens! Low cost options to improve rainwater harvesting in Southern Tajikistan rain fed areas and beyond! 2009 / Training film - Simple ways to improve management of kitchen gardens in Southern Tajikistan rain fed areas and beyond. 2009 / Welthungerhilfe project final narrative report (144-912) - 2010

**Contact person(s):** Domullojonov Daler Welthungerhilfe, Temurmalik office, 77, H. Zarif street, Soviet settlement, Temurmalik district, Khatlon province, Tajikistan, +992 918 248084, daler.domullojonov@welthungerhilfe.de; dalerd@list.ru



## Roof Top Rain Water Harvesting - Concrete Tank

Tajikistan - *Чамоварии оби борон (Russian)*

The roof top rain water harvesting system using a concrete tank was designed to improve household access to water for irrigation of kitchen garden plots during the hot and dry summer months.

A 16 cubic metre concrete tank situated in the shadow of the house constructed to retain rainwater that collects in the roof guttering.

The purpose of the tank is to retain water to be used for drinking, sanitation and irrigation during the hot and dry summer months. The retained water allows for the irrigation of kitchen garden plots and more diverse crops, and hence should improve the livelihoods of households involved.

There are three main elements to the construction of the rainwater harvesting system. The first is the construction of a metal gutter on wooden supports around the perimeter of the roof; second, the construction of a concrete pool in the shadow of the house; and finally the provision of a connection pipe between the gutter and the pool. The pool needs to be cleaned periodically to prevent contamination and build-up of algae around the edge the pool.

During the Soviet period the water supply for the village was supplied through a concrete storage tank located at the foot of the hills above the village. After the collapse of the Soviet Union the concrete tank and its associated infrastructure fell into disrepair. As a result the inhabitants were faced with water shortages, especially during the hot dry summers. In response to this issue the residents invested time, finance and resources into constructing rainwater collection systems.

**Above left:** The plastic pipe running from the roof to the concrete tank. (Photo: S. Stevenson)

**Above right:** The plastic pipe running from the roof to the concrete tank. (Photo: S. Stevenson)

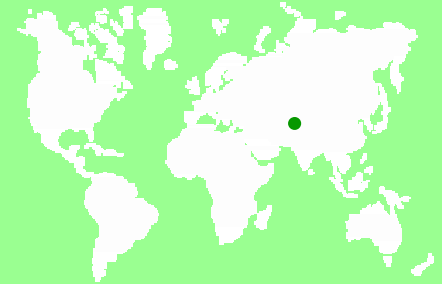

**Location:** Boshkengash

**Region:** Rudaki

**Technology area:** < 0.1 km<sup>2</sup>

**Conservation measure:** structural

**Stage of intervention:** mitigation / reduction of land degradation

**Origin:** developed through land user's initiative, 10-50 years ago

**Land use:** forest/woodland (before), cropland (after)

**Climate:** semi-arid, temperate

**WOCAT database reference:** QT TAJ348en on [cdewocat.unibe.ch/wocatQT](http://cdewocat.unibe.ch/wocatQT)

**Related approach:** not documented





**Compiled by:** Sa'dy Odinaev, Caritas Tajikistan

**Date:** 27th Apr 2011

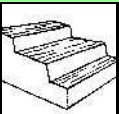
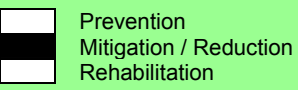
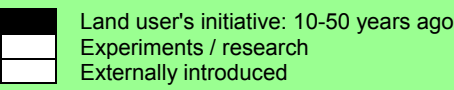
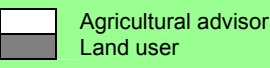

## Classification

**Land use problems:** Lack of water at critical times of the year. The village has 600mm/year of precipitation, but it only falls during two months of the year. The land within the village is becoming increasingly dry and thus more denuded and unsuitable for cultivation.

<p><b>Land use</b></p>  <p>forest / woodlands (before)</p> <p>annual cropping (after)</p> <p>tree and shrub cropping (after)</p>	<p><b>Climate</b></p>  <p>semi-arid, temperate</p>	<p><b>Degradation</b></p>  <p>soil erosion by water: loss of topsoil/ surface erosion</p>	<p><b>Conservation measure</b></p>  <p>structural: dams / pans (to store excessive water)</p>
<p><b>Stage of intervention</b></p>  <p>Prevention Mitigation / Reduction Rehabilitation</p>	<p><b>Origin</b></p>  <p>Land user's initiative: 10-50 years ago Experiments / research Externally introduced</p>	<p><b>Level of technical knowledge</b></p>  <p>Agricultural advisor Land user</p>	
<p><b>Main causes of land degradation:</b> Direct causes - human induced: over/exploitation of vegetation for domestic use</p>		<p><b>Level of technical knowledge</b></p>  <p>high moderate low insignificant</p>	
<p><b>Main technical functions:</b> - water harvesting / increase water supply</p>	<p><b>Secondary technical functions:</b> - water spreading</p>		

## Environment

### Natural Environment

#### Average annual rainfall (mm)

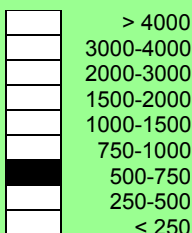

#### Altitude (m a.s.l.)

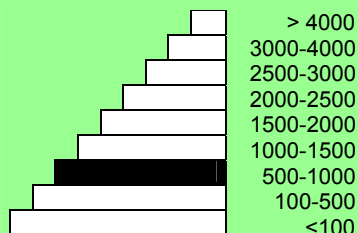

#### Landform

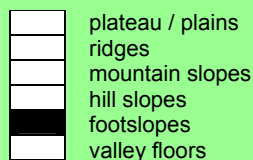

#### Slope (%)



#### Soil depth (cm)

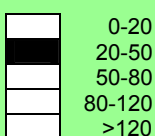

**Growing season(s):** 220 days (March until November)

**Soil texture:** medium (loam)

**Soil fertility:** high

**Topsoil organic matter:** medium (1-3%)

**Soil drainage/infiltration:** medium

**Soil water storage capacity:** low

**Ground water table:** 5 - 50 m

**Availability of surface water:** good, medium, poor / none

**Water quality:** good drinking water, poor drinking water

**Biodiversity:** medium

**Tolerant of climatic extremes:** temperature increase, seasonal rainfall increase, wind storms / dust storms, droughts / dry spells, decreasing length of growing period

**Sensitive to climatic extremes:** droughts / dry spells

**If sensitive, what modifications were made / are possible:** In times of heavy rainfall and prolonged summer drought the size of the tank could be increased.

## Human Environment

### Cropland per household (ha)

█	<0.5
█	0.5-1
█	1-2
█	2-5
█	5-15
█	15-50
█	50-100
█	100-500
█	500-1,000
█	1,000-10,000
█	>10,000

**Land user:** individual / household, small scale land users, common / average land users, men and women  
**Population density:** 100-200 persons/km<sup>2</sup>  
**Annual population growth:** 1 - 2%  
**Land ownership:** state  
**Land use rights:** individual (In regards to the water in the tank, household plots are allocated by the local government. All land is owned by the state.)  
**Water use rights:** individual (In regards to the water in the tank, household plots are allocated by the local government. All land is owned by the state.)  
**Relative level of wealth average,** which represents 70% of land users.

**Importance of off-farm income:** 10-50% of all income: The residents do not have a significant income from their garden plots.  
**Access to service and infrastructure:** low: health, education, technical assistance, drinking water and sanitation, financial services; moderate: employment (e.g. off-farm), market, energy, roads & transport  
**Market orientation:** subsistence (self-supply)  
**Mechanization:** n/ap\*.  
**Livestock grazing on crop residues:** n/ap

\*n/ap: not applicable

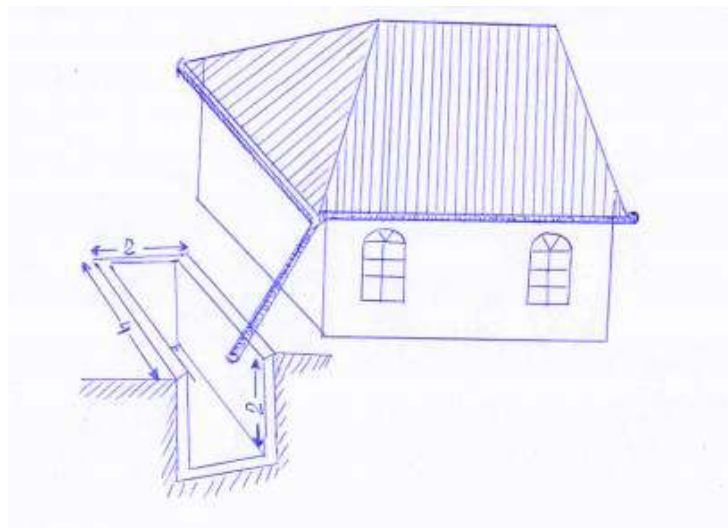

### Technical drawing

The drawing shows the metal guttering (0.15m) wide around the perimeter of the roof top. The guttering collects the rainwater runoff from the roof, and through a plastic pipe made of old plastic bottles stitched together by thin wire it drains into a concrete tank. In this example the tank is 4m long, 2 wide and 2 meters deep and is located within the shadow of the house to reduce evaporation rates. In this example the tank is located on a slope and is partially buried on the upslope. The tank is covered for safety reasons and to prevent external contamination. (Sosin Peter).

## Implementation activities, inputs and costs

### Establishment activities

1. Construction of concrete tank and guttering

### Establishment inputs and costs per ha

Inputs	Costs (US\$)	% met by land user
Labour	100	100
Equipment		
- tools	15	100
Construction material		
- wood	30	100
- cement, stone, sand	150	100
- metal sheet for roof gutter	100	100
- plastic pipe	2	100
<b>TOTAL</b>	<b>397</b>	<b>100</b>

### Maintenance/recurrent activities

1. Cleaning

### Maintenance/recurrent inputs and costs per ha per year

Inputs	Costs (US\$)	% met by land user
Labour	5	100
<b>TOTAL</b>	<b>5</b>	<b>100</b>

**Remarks:** Labour, tools and piping can be provided by the land user and stone for the foundation is locally available, however, there is an initial outlay of \$300 for the cement, wood and metal guttering. In this example the money for the initial outlay was collected by family members working in Russia and from local salaries. The costs were calculated based on 2010 prices per tank.

## Assessment

Impacts of the Technology	
<b>Production and socio-economic benefits</b> +++ increased drinking water availability +++ increased water availability / quality +++ increased irrigation water availability quality ++ increased crop yield ++ reduced expenses on agricultural inputs + increased wood production + decreased workload	<b>Production and socio-economic disadvantages</b> + potential debt issues if finance is borrowed for the initial outlay
<b>Socio-cultural benefits</b> ++ conflict mitigation ++ improved food security / self sufficiency	<b>Socio-cultural disadvantages</b> none
<b>Ecological benefits</b> +++ increased water quantity +++ increased water quality +++ improved harvesting / collection of water ++ increased soil moisture ++ reduced evaporation ++ increased plant diversity	<b>Ecological disadvantages</b> none
<b>Off-site benefits</b> ++ increased water availability	<b>Off-site disadvantages</b> none
<b>Contribution to human well-being/livelihoods</b> +++ Permanent access to water has dramatically improved the sanitation and hygiene levels, and increased crop quality and diversification. It has also improved the quality of and access to drinking water, and therefore has significant health benefits	

+++ : high, ++ : medium, + : low

Benefits/costs according to land user	Benefits compared with costs	
	short-term:	long-term:
	Establishment	very positive
Maintenance/recurrent	very positive	very positive

If it is constructed to a reasonable standard then it will not need any significant maintenance.

**Acceptance/adoption:** 70% of land user families have implemented the technology voluntary. The urban roof top rainwater harvesting has been replicated by many members of the community without external support. There is moderate trend towards (growing) spontaneous adoption of the technology. People observed, and experienced the benefits, and decided that it was worth the initial investment.

## Concluding statements

Strengths and → how to sustain/improve	Weaknesses and → how to overcome
Improves the provision of irrigated water for the hot dry summer periods → further dissemination to other households.	The perception was that the water was not clean in the concrete pool → however, it was tested and proved to be safe to use. This provided reassurance to the household members. It would be a major benefit if the water tank remains covered and is cleaned periodically.
Allowed for the improvement and expansion of kitchen gardens → training on keeping a kitchen garden.	
Improved the quality and quantity of fruit yields.	The initial outlay may be considered expensive for some families → many families have adopted this; possibly if many were built at once the material costs would be reduced. The technology could be tied in with micro finance activities.
Improved the access of water for sanitation and drinking water purposes → education on sanitation methods.	
Improved the standard of living, and the increased access to water allowed the households to have more autonomy over what to grow and eat.	

**Contact person(s):** Odinashoev Saadi CARITAS, 20, Pavlova str, Dushanbe, Tajikistan. tel.985-170-125, E mail: sady.dc@mail.ru



# Annex







HP, Liniger

# Annex

## Annex1 Different definitions of water harvesting

- Water harvesting is the collection of runoff and its use for irrigation of crops, pastures and trees, and for livestock consumption (Finkel and Finkel, 1986).
- Water harvesting is the collection of runoff\* for productive purposes\*\*. This definition by Critchley and Siegert (1991) was and still is often used and cited (e.g. FAO, 1994; Falkenmark et al., 2001; Anderson and Burton, 2009; Scheierling et al., 2013).
- Rainwater harvesting is the collection of runoff from roofs or ground surfaces (Falkenmark et al., 2001; Worm and Hattum, 2006).
- Water harvesting includes all methods of concentrating, diverting, collecting, storing and utilizing and managing runoff for productive use (Ngigi, 2003).
- Water harvesting is the collection of runoff rainwater for domestic water supply, agriculture and environmental management (Worm and Hattum, 2006).
- Water harvesting is the collection and concentration of rainfall runoff for crop production – or for improving the performance of grass and trees – in dry areas where moisture deficit is the primary limiting factor (Liniger and Critchley, 2007).
- Rainwater harvesting is the concentration of runoff from watersheds for beneficial use (Rockström et al., 2007).
- Rainwater harvesting is the collection and concentration of rainfall to make it available for domestic or agricultural uses in dry areas where moisture deficit is the primary limiting factor (Liniger et al., 2011).
- Water harvesting is the collection and concentration of rainwater and runoff and its productive use for irrigation of annual crops, pastures and trees, for domestic and livestock consumption and for ground water recharge (Prinz, 2011).
- Water harvesting is the collection and concentration of rainfall runoff or floodwaters for plant production (Critchley and Scheierling, 2012).
- The process of concentrating precipitation through runoff and storing it for beneficial use (Oweis et. al., 2012).

\* Runoff may be harvested from roofs and ground surfaces as well as from intermittent or ephemeral watercourses

\*\* Productive purposes comprise water for human and livestock consumption and use, water for agriculture (crop, fodder, pasture, trees, kitchen gardens, agro-processing) and for environmental management (forest, protected areas, wildlife).



left: Rock catchment, Kenya.

right: Water stored behind an earth dam in the Loess Plateau, China.



## Annex 2

### End use of harvested water – what is appropriate where.

Water use	Human consumption		Livestock		Agriculture		
	drinking	household	sedentary	pastoralist	production	agro-processing	fisheries
<b>Household</b>	RooftopWH	Rooftop-CourtyardWH MacroWH (small dams, farm ponds, above and below ground tanks)	Rooftop-CourtyardWH MacroWH (small dams, farm ponds, above and below ground tanks)		MicroWH Rooftop-CourtyardWH (kitchen gardens and backyard crops) MacroWH for supplementary irrigation (small dams, farm ponds)	RooftopWH (depending on quantity and quality)	Rooftop-CourtyardWH
<b>Community</b>	RooftopWH on public and industrial buildings, MacroWH (dams and ponds, depending on quality) MacroWH (dams, ponds, tanks)	MacroWH (dams, ponds, tanks)	MacroWH (dams, ponds, tanks)	MacroWH (dams, ponds, tanks)	MicroWH MacroWH and FloodWH to prolong water availability in the soil and for supplementary irrigation	RooftopWH (depending on quantity and quality)	Rooftop-CourtyardWH MacroWH
<b>Watershed / landscape</b>	MacroWH (medium size dams and ponds, depending on quality)	MacroWH (medium size dams and ponds)	MacroWH (medium size dams and ponds)	MacroWH (dams, ponds, tanks)	FloodWH MacroWH to prolong water availability in the soil and for supplementary irrigation MicroWH		MacroWH

FloodWH: Floodwater harvesting; MacroWH: Macrocatchment water harvesting; MicroWH: Microcatchment water harvesting; Rooftop-CourtyardWH: Rooftop and Courtyard water harvesting.

## Annex 3

### Improved water availability and development issues addressed by water harvesting (WH).

	Floodwater harvesting	Macrocatchment WH	Microcatchment WH	Rooftop and Courtyard WH	Overview WH
<b>Water availability:</b>					
Drinking water (high quality)	n/ap	+	n/ap	++	+
Domestic use (household)	n/ap	++	n/ap	+++	++
Livestock sedentary	n/ap	++	n/ap	++	++
Livestock pastoral	+	+++	+	n/ap	++
Rainfed agriculture	+++	++	+++	n/ap	+++
Opportunistic irrigation	+++	+	n/ap	n/ap	++
Supplementary irrigation	+	+++	n/ap	+	++
Irrigation of backyard crops/ kitchen gardens	n/ap	++	+	+++	++
Aquifer recharge	+++	++	+	n/ap	++
Agro-processing	n/ap	+	n/ap	++	+
<b>Development issues:</b>					
Preventing / reversing land degradation	+	++	+++	n/ap	++
Maintaining and improving food security	+	+++	+++	+	++
Reducing rural poverty	+	++	++	++	++
Creating rural employment	+	++	+	++	+
Supporting gender equity/ marginalized groups	+/-	+	+	+++	+
Reduced risk of production failure	+	++	+++	+	++
Improving crop production (including fruit trees)	++	+++	+++	+	+++
Improving fodder production	+	++	++	n/ap	++
Improving wood / fibre production	+	++	++	n/ap	++
Improving water productivity	+	++	+	++	++
Trapping sediments and nutrients	+++	+++	++	n/ap	++
Enhancing biodiversity	+	+++	++	+	++
Natural disaster prevention/mitigation	++	++	+	+	++
Climate change mitigation	++	++	+++	+/-	++
<b>Climate change adaptation:</b>					
Resilience to extreme dry cond.	+/-	++	+	+	+
Resilience to variable rainfall	+	+++	++	++	++
Resilience to extreme rain and wind storms	++	++	+	+++	++
Resilience to rising temperatures and evaporation rates	++	++	++	+++	++

Importance: +++ high, ++ medium, + low, +/- neutral, n/ap: not applicable

Source: Part 2 of this publication; Liniger et al., 2011.

## Annex 4 Water harvesting organisations and recurrent events

Below is a compilation of the main WH organisations – networks and actors – showing in which WH field they work, and what their main activities comprise.

### Main water harvesting organisations

Name of organisation	Type				Geographical focus	WH purpose	Activities	Web address
	Network	NGO	International organisation	Research project				
Agricultural Water Management Solutions		+			Africa, Asia	a	k/r	<a href="http://awm-solutions.ivmi.org">http://awm-solutions.ivmi.org</a>
American Rainwater Catchment Systems Association (ARCSA)	+				N America, L America	d	c/t/p/k/f/i/m/e/r	<a href="http://www.arcsa.org">www.arcsa.org</a>
Arab Centre for the Studies of Arid Zones and Dry Lands (ACSAD)		+/-			Middle East			<a href="http://www.acsad.org">www.acsad.org</a>
Associação Brasileira de Captação e Manejo de Água de Chuva		+			L America	d	c/t/p/k	<a href="http://www.abcmac.org.br">www.abcmac.org.br</a>
Barefoot college		+/-			Asia	d	c/t/p/k/f/i/p	<a href="http://www.barefootcollege.org">www.barefootcollege.org</a>
Be Buffered	+				Global	a	p/k	<a href="http://www.bebuffered.com">www.bebuffered.com</a>
Capacity Building for Sustainable Water Resources Network (Cap-Net)	+/-				Africa, Asia, L America	a	c	<a href="http://www.cap-net.org">www.cap-net.org</a>
Centre for Science and Environment (CSE)		+/-			Asia	d/a	c/t/p/k	<a href="http://www.rainwaterharvesting.org">www.rainwaterharvesting.org</a>
Centro Internacional de Demostración y Capacitación en Aprovechamiento del Agua de Lluvia		+			L America	d	c/t/p/k/r	<a href="http://www.colpos.mx/ircsa/cidecall">www.colpos.mx/ircsa/cidecall</a>
Eau et Assainissement pour l'Afrique		+			Africa	d	c/p	<a href="http://www.wsafrica.org">www.wsafrica.org</a>
Eau Vive		+			West Africa	d	c/t/i/p	<a href="http://www.eau-vive.org">www.eau-vive.org</a>
Ethiopian Rainwater Harvesting Association (ERHA)	+				Ethiopia	d/a	c/t/p/k/i/p	<a href="http://www.ethiorainwater.org">www.ethiorainwater.org</a>
European Rainwater Catchment Systems Association (ERCSA)		+			Europe	d/a	c/t/p/k	<a href="http://www.ercsa.eu">www.ercsa.eu</a>
Excellent		+			Africa	d/a	c/t/i/p	<a href="http://www.excellentdevelopment.com">www.excellentdevelopment.com</a>
Fachverein für Betriebs- und Regenwassernutzung Ev.		+			Germany	d	c/t/p/k	<a href="http://www.fbr.de">www.fbr.de</a>
FogQuest: Sustainable Water Solution		+			Africa, L America	d	c/t/p/k/i/p	<a href="http://www.fogquest.org">www.fogquest.org</a>
Global Applied Research Network (GARNET) for the theme "rainwater harvesting"	+				Global	d/a	r	<a href="http://info.lut.ac.uk/departments/cv/wedc/garnet/tncrain.html">http://info.lut.ac.uk/departments/cv/wedc/garnet/tncrain.html</a>
Global Water Partnership	+/-				Global	a	c/t/p/k	<a href="http://www.gwp.org">www.gwp.org</a>
Greater Horn of Africa Rainwater Partnership (GHARP)	+				Africa	d/a	c/t/p/k/m/e/r	<a href="http://www.gharainwater.org">www.gharainwater.org</a>
Hawai'i Rainwater Catchment Systems Program		+			Hawaii	d	t/k/r	<a href="http://www.ctahr.hawaii.edu">www.ctahr.hawaii.edu</a>
Household water treatment and safe storage	+				Global	d/a	p/k/r	<a href="http://www.who.int/household_water">www.who.int/household_water</a>
International Centre for Agricultural Research in the Dry Areas (ICARDA)		+/-			Global	a	c/t/p/k/i/p/m/e/r	<a href="http://www.icarda.org">www.icarda.org</a>
International Fund for Agriculture Development (IFAD)			+/-		Global	d/a	c/f/m/e/r	<a href="http://www.ifad.org">www.ifad.org</a>
International Groundwater Resources Assessment Centre (IGRAC)	+/-				Global	a	k/r	<a href="http://www.un-igrac.org">www.un-igrac.org</a>
International Office for Water		+/-			Global	a	c/t/p/k/i/p	<a href="http://www.oieau.fr">www.oieau.fr</a>
International Rainwater Catchment Systems Association (IRCSA)		+			Global	d	p/k	<a href="http://www.eng.warwick.ac.uk/ircsa">www.eng.warwick.ac.uk/ircsa</a>
International Rainwater Harvesting Alliance (IRHA)		+			Global	d	c/t/k/f/i	<a href="http://www.irha-h2o.org">www.irha-h2o.org</a>
International Water Management Institute (IWMI)			+/-		Global	a	c/t/p/k/i/p/m/e/r	<a href="http://www.iwmi.cgiar.org">www.iwmi.cgiar.org</a>
Japan Rainwater Catchment Systems Association		+/-			Japan			<a href="http://www.rain.jp">www.rain.jp</a>
Kenya Rainwater Association (KRA)	+				Kenya		c/t/p/k	<a href="http://www.gharainwater.org/kenya-kra">www.gharainwater.org/kenya-kra</a>

Know With The Flow		+/-		Global	a	k	www.knowwiththeflow.org
Lanka Rain Water Harvesting Forum		+		Sri Lanka	d	c/t/p/k	www.lankarainwater.org
Maji na Ufanisi (Water and Development)		+/-		Kenya	d	p/i/r	www.majinaufanisi.com
MetaMeta Research		+/-		Global	a	c/t/p/k/r	www.metameta.nl
Micro Water Facility		+/-		Africa, Asia	d	f	/www.microwaterfacility.org
Multiple Use Water Services (MUS-Group)	+/-			Africa, Asia, L America	d/a	t/k/r	www.musproject.net
Mvula Trust		+/-		Africa, Asia	d/a	c/k/i/p	www.mvula.co.za
People for Rainwater		+		Japan	d	p/k	www.skywater.jp
Rainharvesting systems		+		United Kingdom	d	i/p	www.rainharvesting.co.uk
Rainwater Association of Somalia (RAAS)	+			Somalia	d	t/k/r	www.gharainwater.org/raas_aboutus.html
RainWater Cambodia		+		Cambodia	d	c/t/p/k/i	www.rainwatercambodia.org
Rainwater Club		+		India	d/a	c/t/i	www.rainwaterclub.org
Rainwater Harvesting Capacity Centre (RHCC)		+		Nepal	d/a	c/t/p/k/m/e/r	www.bspnepalrhcc.org
Rainwater Harvesting Implementation Network (RAIN)	+			Africa, Asia	d/a	c/t/k/i/r	www.rainfoundation.org
Red de Agua y Saneamiento de Honduras (RAS-HON)	+/-			Honduras	d	c/p	www.rashon.org
Rural Water Supply Network (RWSN)	+/-			Global	d/a	c/t/k/f/i	/www.rural-water-supply.net
Safe Water International		+/-		Global	d	i	www.safewaterintl.org
SamSam Water		+/-		Africa, Asia	d/a	k/i/r	www.samsamwater.com
SearNet	+			Eastern & Southern Africa	d/a	c/k/p	http://worldagroforestry.org/projects/searnet/
Small Reservoirs Project			+	Africa, Asia	a	k/r	www.smallreservoirs.org
Soil and Water Conservation Society		+/-		Global	a	c/r	www.swcs.org
Spate Irrigation Network		+		Africa	a	c/t/p/k/i/r	www.spate-irrigation.org
Stockholm International Water Institute (SIWI)			+/-	Global	a	c/p	www.siwi.org
Swiss Water Kiosk		+/-		Africa, Asia	d	i/p	http://swisswaterkiosk.org
Systema Iberoamericano de Informacion sobre el Agua	+/-			L America	d	k	www.siagua.org
The African Civil Society Network on Water and Sanitation	+/-			Africa	d/a	c	www.anewafrika.org
The Water Project		+/-		Africa	d	f	http://thewaterproject.org
The Global Rainwater Harvesting Collective		+		India	d	c/t/i/p	http://globalrainwaterharvesting.org
Uganda Rain Water Association (URA)	+			Uganda	d	c/t/p/k	www.ugandarainwater.org
UN Water	+/-			Global	d/a	p	www.unwater.org
Verband Regenwassernutzung Schweiz	+			Switzerland	d	p	www.vrs-regenwassernutzung.ch
Water Aid		+/-		Africa, Asia, L America	d	c/t/k/i/r	www.wateraid.org
Water for Arid Lands (ASAL)		+		Africa	a	p/k/i/p	http://waterforaridland.com
Water Harvesting for Rainfed Africa (WAHARA)			+	Africa	a	r	www.wahara.eu
Water Harvesting Technologies Revisited (WHaTeR)			+	Africa	a	r	http://whater.eu
Watershed Organisation Trust (WOTR)		+/-		India		c/t/p/k	http://www.wotr.org
World Overview of Conservation Approaches and Technologies (WOCAT)	+/-			Global	d/a	k/m/e/r	www.wocat.net
World Water Council (WWC)	+/-			Global	d/a	p/k	www.worldwatercouncil.org

#### Legend

**Actors:** +: only water harvesting, +/-: also water harvesting

**Geographical focus:** N America: North America, L America: Latin America

**WH purpose:** d: domestic (incl. drinking water and sanitation), a: agriculture (incl. livestock)

**Activities:** c: capacity building, t: technical advice, p: promotion, k: knowledge sharing, f: financial support, i: implementation, p: planning, m: monitoring, e: evaluation, r: research

## Details of specific water harvesting organisations

The organisations detailed below are a limited selection, comprising those approached and responding to a survey conducted

Actor	Geographical focus			Activities							Website	
	Global	Regional	Local	Financial support	Promotion	Planning	Technical advice	Implementation	Monitoring & Evaluation	Research		Knowledge exchange
RAIN Foundation		West Africa, East Africa, South Asia	Burkina Faso, Mali, Senegal, Kenya, Uganda, Ethiopia, Nepal and Bangladesh	■	■		■	■	■		■	<a href="http://www.rainfoundation.org">www.rainfoundation.org</a>
Rainwater Catchment Program		Micronesia & State of Hawaii	Mostly the state of Hawaii but also get requests from other states in the USA				■				■	<a href="http://www.hawaiirain.org">www.hawaiirain.org</a> or <a href="http://www.ctahr.hawaii.edu/hawaiirain/">www.ctahr.hawaii.edu/hawaiirain/</a>
Lanka Rain Water Harvesting		South Asia	Sri Lanka		■		■	■	■		■	<a href="http://www.lankarainwater.org">www.lankarainwater.org</a>
American Rainwater Catchment Systems Association (ARCSEA)		Americas		■	■	■	■	■	■	■	■	<a href="http://www.arcsa.org">www.arcsa.org</a> or <a href="http://www.design-aire.com">www.design-aire.com</a>
International Rainwater Harvesting Alliance (IRHA)	x		United States, Mexico, Canada, Virgin Islands, Brazil	■	■		■	■	■		■	<a href="http://www.irha-h2o.org">www.irha-h2o.org</a>
Rainwater Association of Somalia (RAAS)					■	■	■	■	■	■	■	<a href="http://www.gharainwater.org">www.gharainwater.org</a>
Rural Water Supply Network (RWSN)	x		Somalia				■				■	<a href="http://www.rwsn.ch">www.rwsn.ch</a>

■ active    □ inactive

## Recurrent WH Events – with next occurrence/ latest year convened

### General

- Delft Symposium.** 5th symposium on: Water Sector Capacity Development, 29 – 31 May 2013; Delft, the Netherlands. Organised by UNESCO-IHE. <http://www.source.irc.nl/page/742105thDelft>; <http://www.unesco-ihe.org/CD-Symposium>.
- International Conference on Rainwater Catchment Systems.** 15th conference on: Worldwide Multi-Objective Rainwater Harvesting and Utilization, 28 March – 4 April 2011; China. Organised by: International Rainwater Catchment Systems Association (IRCSA); Chinese Culture University, Taipei; National Cheng Kung University, Tainan.
- International Water Week Amsterdam.** Conference, 4 – 8 November 2013; Amsterdam, the Netherlands (biannual water industry event). Organised by: Amsterdam RAI, International Water Association (IWA), KNW Royal Netherlands Water Network, Netherlands Water Partnership (NWP) and Waternet
- International World Water Day (WWD)** held annually. WWI, 22 March 2013 in the Netherlands. Hosted by: the Dutch Government and coordinated by UNESCO and UNECE with the support of UN-Water Members and Partners. <http://www.source.irc.nl/page/75482>
- International water association (IWA) – Rainwater Harvesting Management (RWHM) conference and exhibition.** 3rd conference, 20 – 24 May 2012; Gyeongnam, Goseong County, Republic of Korea. [www.3rwhm.org](http://www.3rwhm.org)
- International Forum on Water and Food** organised by CGIAR Challenge Program on Water and Food (CPWF)
- Multiple Use water Services MUS Group meetings.** Thematic group meetings held annually. <http://www.musgroup.net/page/315>
- SearNet conference.** 15th conference, 4 – 9 November 2012; Nairobi and Naivasha, Kenya. Hosted by the Kenya Rainwater Association with support from SearNet and the World Agroforestry Centre. <http://worldagroforestry.org/projects/searnet/>
- Water Reuse conference.** Conference on: Blue Resource of the Future, 27-31 October 2013; Windhoek, Namibia. <http://www.source.irc.nl/page/73310>
- World Water Forum.** 7th Forum 2015, Daegu and Gyeongbuk, Republic of Korea (organised every three years) <http://www.source.irc.nl/page/75458>
- World Water Week in Stockholm.** Conference, 01 – 06 September 2013; Stockholm, Sweden. Organised by: Stockholm International Water Institute (SIWI). <http://www.source.irc.nl/page/75651>, <http://www.worldwaterweek.org/>

### Floodwater harvesting

- Annual Short Course on Spate Irrigation at UNESCO-IHE.** <http://www.unesco-ihe.org/Education/Non-degree-Programmes/Short-courses/Spate-Irrigation-and-Water-Management-under-Drought-and-Water-Scarcity>
- Double Degree MSc Course on Spate Irrigation** between Haramaya University and UNESCO-IHE

### Macrocatchment WH

- Conference IWA Specialist Group Ponds Technology.** 10 th conference on: Advances and Innovations in Pond Treatment Technology, 19-22 August 2013; Cartagena, Colombia. Organised by: International Water Association (IWA). <http://www.source.irc.nl/page/73308>
- International Conference Sustainable Water Resource Management.** 7 th conference on: Water Resources Management, 21 – 23 May, 2013; New Forest, UK. Organised by: Wessex Institute of Technology, UK. <http://www.wessex.ac.uk/13-conferences/water-resources-management-2013.html>

### Rooftop WH

- Africa Water Week organized by the African Ministers Council on Water (AMCOW).** <http://www.africawaterweek.com/index.php>
- Asia Water Week.** AWW, 13 – 15 March 2013; ADB Headquarters, Manila, Philippines. Organised by: Asian Development Bank (ADB). <http://www.source.irc.nl/page/72824>
- CSE Training Programme on Urban Rainwater Harvesting.** Training, 27 – 29 March 2012, New Delhi, India. Centre for science and environment (CSE). <http://www.cseindia.org/content/training-programme-urban-rainwater-harvesting-march-27-29-2012>
- India Water Week.** IWW, 8 – 12 April 2013; New Delhi, India. Organised by: Ministry of Water Resources, Government of India, National Water Development Agency and Central Water Commission. <http://www.source.irc.nl/page/75479>
- International Water Association (IWA) Development Congress & Exhibition.** 3rd Congress, 14 – 17 October 2013; Nairobi, Kenya. Organised by: (IWA), Water Services Providers Association (WASPA) and Nairobi City Water and Sewerage Company (NCWSC). <http://www.source.irc.nl/page/75967>
- International Water and Sanitation Centre (IRC) Symposium.** Symposium on: Monitoring Sustainable Water, Sanitation and Hygiene (WASH) Service Delivery, 9 – 11 April 2013; Addis Ababa, Ethiopia. <http://www.irc.nl/page/72969>
- Rural water supply network (RWSN) Forum.** Forum takes place every three to four years (last held 29.11 – 1.12, 2011 on: 'Rural Water Supply in the 21st Century: Myths of the Past, Visions for the Future'.)
- Water, Sanitation and Hygiene (WASH) Sustainability Forum.** Forum, 11 March, 2013. Organized by: World Bank, UNICEF, Global Water Challenge, WASH Advocates, Aguaconsult, and the International Water and Sanitation Centre (IRC). <http://www.source.irc.nl/page/76191>
- World Water Summit.** WWS V, 21 June 2013; Lisbon, Portugal. Organised by: Water & Sanitation Rotarian Action group (Wasrag). <http://www.source.irc.nl/page/76200>
- Water Week Latinoamérica.** WWLA, 17 – 22 March 2013; Viña del Mar, Chile. Organised by: Fundación Chile and Diario Financiero, in collaboration with AIDIS, DesalData, Global Water Intelligence, and The Nature Conservancy. <http://www.source.irc.nl/page/75433>

## Annex 5: A classification of the literature reviewed and references cited

This classified literature list does not claim to be comprehensive. It is an attempt to assess the latest publications and literature that address water harvesting – while not overlooking older, standard works. Literature in this context is meant as an umbrella term, ranging from peer-reviewed papers and articles, to policy briefs, fact sheets and audio-visual materials. It illustrates the literature that we came across and used to write and compile this guide on water harvesting. Ease of access has led to some bias towards material published in English. This review process is not concluded, but opens for updating and adding to: it is expected that there will be acceleration in documentation about water harvesting in the years to come as valuable experience is gathered.

The categories chosen to classify the literature and references are:

- Publications, guidelines and source books
- Good practices, experiences and case studies
- Manuals, practical guides and training material
- Journal articles, conference and working papers
- Policy briefs, fact sheets, presentations and others
- Selection of audio-visual media

### Publications, guidelines and source books

- Adank, M., van Koppen, B. and S. Smits. 2012. Guidelines for Planning and Providing Multiple Use Water Services. International Water and Sanitation Centre (IRC) and International Water Management Institute (IWMI). <http://www.musgroup.net>
- Agarwal, A., Narain, S. and I. Khurana (eds). 2001. Making Water Everybody's Business: Practice and Policy of Water Harvesting. Centre for Science and Environment (CSE). New Delhi, India.
- Agarwal, A. and S. Narain. (eds). 1997. Dying Wisdom: Rise, fall and potential of India's traditional water harvesting systems. Centre for Science and Environment (CSE), New Delhi, India.
- Barron, J. 2009. Rainwater Harvesting: a Lifeline for Human Well-Being. United Nations Environment Programme (UNEP), Nairobi / Environment Institute (SEI), Stockholm.
- Batchelor, C., Fonseca, C. and S. Smits. 2011. Life-cycle costs of rainwater harvesting systems. Occasional Paper 46 (online). International Water and Sanitation Centre (IRC) / Water, Sanitation and Hygiene (WASH)Cost / Rainwater Harvesting Implementation Network (RAIN). The Hague, The Netherlands. <http://www.irc.nl/op46>.
- Clements, R., Haggard, J., Quezada, A. and J. Torres. 2011. Technologies for Climate Change Adaptation: Agriculture Sector. Roskilde: UNEP Risø Centre on Energy, Climate and Sustainable Development.
- CFS (Committee on World Food Security). 2012. Voluntary Guidelines on the Responsible Governance of Tenure of Land, Fisheries and Forests in the Context of National Food Security. Food and Agriculture Organization (FAO). Rome, Italy.
- Critchley, W. R. S. 2010. More People, More Trees: Environmental Recovery in Africa. Practical Action Publishing, Rugby, UK.
- Critchley, W. 2009. Soil and Water Management Techniques in Rainfed Agriculture: State of the Art and Prospects for the Future. Background note prepared for the World Bank, Washington D.C.
- Critchley, W. and S. Scheierling. 2012. Water Harvesting for Crop Production in Sub-Saharan Africa: Challenges, Concepts and Practices. In Critchley, W. and J. Gowing (eds). Water Harvesting in Sub-Saharan Africa. Earthscan.
- Desti, L., Carucci, V., Wendem-Agenehu, A. and Y. Abebe (eds). 2005. Community Based Participatory Watershed Development. Part 1: A Guideline, Part 2: Annex. Ministry of Agriculture and Rural Development, Addis Ababa, Ethiopia.
- Duveskog, D. 2003. Soil and Water Conservation with a Focus on Water Harvesting and Soil Moisture Retention: a study guide for farmer field schools and community-based study groups. Harare, FARMESA.
- Elliott, M., Armstrong, A., Lobuglio, J. and J. Bartram. 2011. Technologies for Climate Change Adaptation. The Water Sector. Roskilde: UNEP Risø Centre on Energy, Climate and Sustainable Development.
- Everson, C., Everson, T.M., Modi, A.T., Csiwila, D., Fanadzo, M., Naiken, V., Auerbach, R.M.B., Moodley, M., Mtshali, S.M. and R. Dladla. 2011. Sustainable techniques and practices for water harvesting and conservation. Research Report No.1465/1/11. South African Water Harvesting Commission.
- Falkenmark, M., Fox, P., Persson, G. and J. Rockström. 2001. Water Harvesting for Upgrading of Rainfed Agriculture: Problem Analysis and Research Needs. Stockholm International Water Institute (SIWI) Report 11, Stockholm.
- FAO. 1994. Water Harvesting for Improved Agricultural Production. Proceedings of the Food and Agricultural Organization of the UN (FAO) Expert Consultation, November 1993. Cairo, Egypt.
- Faurès, J.M. and G. Santini (eds). 2008. Water and the Rural Poor: Interventions for improving livelihoods in Sub-Saharan Africa. Food and Agricultural Organization of the UN (FAO) Land and Water Division and International Fund for Agricultural Development (IFAD), Rome.
- Finkel, H.J. and M. Finkel. 1986. Engineering Measures: Water Harvesting. In Finkel, H.J., Finkel, M. and Z. Naveh (eds). Semi-Arid Soil and Water Conservation. CRC Press, Inc., Boca Raton, Florida, USA.
- Foster, T. 2012. Private Sector Provision of Rural Water Services: a Desk Study for Water for People.
- Gabathuler, E., Bachmann, F. and A. Klaey. 2011. Reshaping Rural Extension – Learning for Sustainability (LforS): an integrative and learning-based advisory approach for rural extension with small-scale farmers. Margraf Publishers.
- Graaff de, J. and M. Ouessar. 2002. Water harvesting in Mediterranean zones: an impact assessment and economic evaluation. Proceedings from EU WAHIA project final seminar in Lanzarote.
- Hudson, N.W. 1987. Soil and Water Conservation in Semi-Arid Areas. Food and Agriculture Organization of the United Nations (FAO). Rome, Italy.
- Ibraimo, N. and P. Mungambe. 2007. Rainwater Harvesting Technologies for Small Scale Rainfed Agriculture in Arid and Semi-arid Areas. Department of Rural Engineering, Faculty of Agronomy and Forestry Engineering, University of Eduardo Mondlane, Mozambique.
- ICIMOD. 2009. Mountain Development Resource Book for Afghanistan. International Centre for Integrated Mountain Development (ICIMOD). Kathmandu, Nepal.
- IFAD. 2011. New realities, new challenges, new opportunities for tomorrow's generation. Rural poverty report 2011. International Fund for Agricultural Development (IFAD). Rome, Italy.
- IWMI (International Water Management Institute). 2008. Areas of physical and economic water scarcity. United Nations Environment Programme (UNEP) / GRID-Arendal Maps and Graphics Library.

- IWMI (International Water Management Institute). 2009. Flexible water storage options for adaptation to climate change. IWMI, Colombo, Sri Lanka.
- Kiepe, P. 2006. Characterisation of three key environments for integrated irrigation-aquaculture and their local names. In Halwart, M. and A.A. van Dam (eds). *Integrated Irrigation and Aquaculture in West Africa: concepts, practices and potential*: pp. 1–6. FAO, Rome.
- Koohafkhan, P. and B.A. Stewart. 2008. *Water and Cereals in Drylands*. Earthscan, London.
- Lawrence, P. and F. van Steenberg. 2005. *Improving Community Spate Irrigation*. Report OD 154. HR Wallingford Limited and DFID.
- Mati, B. M. 2005. Overview of water and soil nutrient management under smallholder rainfed agriculture in East Africa. Working Paper 105. International Water Management Institute (IWMI), Colombo, Sri Lanka.
- Molden, D. (ed). 2007. *Water for Food, Water for Life: Comprehensive Assessment of Water Management in Agriculture*. Earthscan and International Water Management Institute (IWMI). London and Colombo.
- Oweis, T.Y., Prinz, D. and A.Y. Hachum. 2012. *Water Harvesting for Agriculture in the Dry Area*. ICARDA, CRC Press/ Balkema, Leiden, the Netherlands.
- Oweis, T., Hachum, A. and A. Bruggeman (eds). 2004. *Indigenous Water Harvesting Systems in West Asia and North Africa*. International Center for Agricultural Research in the Dry Areas (ICARDA). Aleppo, Syria
- Oweis, T.Y., Prinz, D. and A.Y. Hachum. 2001. *Water Harvesting: Indigenous Knowledge for the Future of the Drier Environments*. International Center for Agricultural Research in the Dry Areas (ICARDA). Aleppo, Syria.
- Potsdam Institute for Climate Impact Research and Climate Analytics. 2012. Turn Down the Heat: Why a 4 °C Warmer World Must be Avoided. International Bank for Reconstruction and Development / The World Bank; Washington D.C.
- Prinz, D. 2001. *Water Harvesting for Afforestation in Dry Areas*. Paper read at 10th International Conference on Rainwater Catchment Systems, Mannheim, 10-14 Sept. 2001, at Mannheim.
- Prinz, D. 1996. *Water harvesting: Past and Future*. In Pereira, L.S. (ed). *Sustainability of Irrigated Agriculture*. Proceedings, NATO Advanced Research Workshop, Vimeiro, 21 – 26.03.1994. Balkema, Rotterdam.
- Prinz, D. and A.H. Malik. 2002. *More Yield with Less Water: how efficient can be water conservation in agriculture?* Paper read at 5th International EWRA Conference on Water Resources Management in the Era of Transition, Athens, Greece, 4- 8 September 2002.
- Prinz, D. and A. Singh. 2000. *Technological Potential for Improvements of Water Harvesting*. Contributing paper to the World Commission on Dams. Cape Town, South Africa.
- Reij, C., Scoones, I. and C. Toulmin 1996. *Sustaining the Soil: Indigenous Soil and Water Conservation in Africa*. London: Earthscan.
- Rocheleau, D., Weber, F. and A. Field-Juma. 1988. *Agroforestry in Dryland Africa*. International Council for Research in Agroforestry (ICRAF). Nairobi, Kenya.
- Rockström, J., Hatibu, N., Oweis, T.Y., Wani, S., Barron, J., Bruggeman, A., Farahani, J., Karlberg, L. and Z. Qiang. 2007. *Managing Water in Rainfed Agriculture*. In Molden, D. (ed). *Water for Food, Water for Life: Comprehensive Assessment of Water Management in Agriculture*. Earthscan and International Water Management Institute (IWMI), London and Colombo.
- Safriel, U. and Z. Adeel. 2005. *Dryland Systems*. In Hassan, R., Scholes, R. and N. Ash (eds). *Ecosystems and Human Wellbeing: Current State and Trends*. Vol. 1. Island Press. Washington DC.
- Sanghi, N.K., Ravindra, A., Ramachandrudu, M.V., Suresh, K. (WASSAN); Sen, R. (WDCU); Tucker, S.P., Narasimha Reddy, N.L., Ravindranath, S., Narendra Babu, P. (PLF); Lobo, C., Samuel, A. (WOTR); Satyanarayana, K.V., Reddy, V.K., Renuka Rani, B., Sai Maheswari, K. (MANAGE). 2005. *Upscaling of Successful Experiences in the Mainstream Watershed Programme in India: Mechanisms, Instruments and Policy Considerations*. Watershed Development Coordination Unit (WDCU), Watershed Support Services and Activities Network (WASSAN), Poverty Learning Foundation (PLF), Watershed Organization Trust (WOTR), National Institute of Agricultural Extension Management (MANAGE).
- Scheierling, S.M., Critchley, W. R. S., Wunder, S. and J.W. Hansen. 2013. *Improving Water Management in Rainfed Agriculture: Issues and options in water-constrained production systems*. Water Paper, Water Anchor, The World Bank.
- Tiffen, M., Mortimore, M. and F. Gichuki. 1994. *More People, Less Erosion: Environmental Recovery in Kenya*. John Wiley & Sons, Chichester, UK.
- UNEP-Environmental management group. 2011. *Global Drylands: a UN system-wide response*. United Nation Environment Programme (UNEP). [http://www.unep-wcmc.org/global-drylands-a-un-system-wide-response\\_801.html](http://www.unep-wcmc.org/global-drylands-a-un-system-wide-response_801.html)
- UNEP. 2002. *Rainwater Harvesting and Utilization – an Environmentally Sound Approach for Sustainable Urban Water Management: an introductory guide for decision makers*. United Nations Environment Programme (UNEP) Division of Technology, Industry and Economics. <http://www.unep.or.jp/ietc/Publications/Urban/UrbanEnv-2/index.asp>
- UNEP-IWSD (Institute of Water and Sanitation Development). 1998. *Sourcebook of Alternative Technologies for Freshwater Augmentation in Africa*. Online Technical Publication Series. United Nation Environment Programme (UNEP). <http://www.unep.or.jp/ietc/publications/techpublications/techpub-8a/permeable.asp>.
- UNEP-IETC (United Nation Environment Programme – International Environmental Technology Centre). 1998. *Sourcebook of Alternative Technologies for Freshwater Augmentation in some Asian Countries*. IETC Technical Publication Series 8b, UNEP-IETC/Danish Hydraulic Institute. <http://www.unep.or.jp/ietc/Publications/techpublications/TechPub-8e/index.asp>
- UNEP-IETC (United Nation Environment Programme – International Environmental Technology Centre). 1998. *Sourcebook of Alternative Technologies for Freshwater Augmentation in Small Island Developing States*. IETC Technical Publication Series. UNEP-IETC/Danish Hydraulic Institute. <http://www.unep.or.jp/ietc/Publications/techpublications/TechPub-8d/index.asp>
- Van Steenberg, F., Verheijen, O., van Aarst, S. and A.M. Haile. 2008. *Spate Irrigation: Livelihood Improvement and Adaptation to Climate Variability and Change*. International Fund for Agricultural Development (IFAD) / MetaMeta / UNESCO-IHE. [http://www.spate-irrigation.org/wordpress/wp-content/uploads/2011/06/IFAD\\_MM\\_spate\\_irrigation.pdf](http://www.spate-irrigation.org/wordpress/wp-content/uploads/2011/06/IFAD_MM_spate_irrigation.pdf)
- Van Steenberg, F., Lawrence, P., Haile A.M., Salman, M. and J-M.Faurès. 2010. *Guidelines on Spate Irrigation*. FAO Irrigation and Drainage Paper. Food and Agricultural Organization of the UN (FAO). Rome, Italy. <http://www.fao.org/docrep/012/i1680e/i1680e.pdf>
- Von Grebmer, K., Ringler, C., Rosegrant, M.W., Olofinbiyi, T., Wiesmann, D., Fritschel, H., Badiane, O., Torero, M., Yohannes, Y. (International Food Policy Research Institute, IFPRI); Thompson, J. (Concern Worldwide); von Oppeln, C., Rahall, J. (Welthungerhilfe and Green Scenery). 2012. *Global Hunger Index – the Challenge of Hunger: Ensuring sustainable food security under land, water, and energy stresses*. Washington, DC. [http://www.ifpri.org/sites/default/files/ghi12\\_scores\\_severity.pdf](http://www.ifpri.org/sites/default/files/ghi12_scores_severity.pdf)
- Waes, van B. and N. Bouman. 2007. *Smart Water Harvesting Solutions: examples of innovative low-cost technologies for rain, fog, runoff water and groundwater*. Water Partnership/ A4A/ Agromisa/ Partners for Water. Netherlands.
- Wani, S.P., Sreedevi, T.K., Rockström, J. and Y.S. Ramakrishna. 2009. *Rainfed Agriculture: Past Trends and Future Prospects*. In Wani, S.P., Rockström, J. and T. Oweis (eds). *Rainfed Agriculture: Unlocking the Potential*. Comprehensive Assessment of Water Management in Agriculture 7.
- WB (The World Bank). 1988. *Sub-Saharan Africa Water Harvesting Study*.



## Good practices, experiences and case studies

- African Development Bank. 2009. Rainwater Harvesting Handbook: Assessment of Best Practises and Experience in Water Harvesting. African Development Bank, Tunis. <http://www.rwsn.ch/documentation/skatdocumentation>
- AgWater Solutions – Improved Livelihoods for smallholder farmers. Promising Solutions. Accessed December 2012. <http://awm-solutions.iwmi.org>
- Anderson, I.M. and M. Burton. 2009. Best Practices and Guidelines for Water Harvesting and Community Based (Small Scale) Irrigation in the Nile Basin. Water Harvesting Report. Part I – Best Practices in Water Harvesting. Part I – Best Practices in Water Harvesting. Appendices. Part II – Guidelines for the implementation of best practices in Water Harvesting. Part II – Guidelines for the implementation of best practices in Water Harvesting. Appendix A: List of Reference Material. Kent, Nile Basin Initiative. Efficient Water Use for Agricultural Production Project (EWUAP).
- Beernaerts, I. (ed). 2008. Model on “Economic analysis of rainwater harvesting for crop production”. FAO Sub-regional Office for West Africa (SFW).
- Benicke, C. 2001. Costs and Benefits of Adopting Runoff Irrigation Systems: a case study from Kakuma, northern Kenya. Universität Bayreuth, Germany.
- Borst, I. and S.A. de Haas. 2006. Hydrology of Sand Storage Dams: a case study in the Kiindu catchment, Kitui District Kenya, MSc thesis Hydrology, VE University, Amsterdam.
- Botoni, E., Reyssset, M.B., Ndiaye, O. et S. Ouedraogo. 2009. Récupération des sols fortement dégradés à des fins silvo-pastorales: une évaluation quantitative des aménagements mécaniques à partir de la charrue Delfino réalisés par l'ONG REACH au Burkina Faso. Comité permanent Inter- États de Lutte contre la Sécheresse dans le Sahel (CILSS) et Commission Européenne au Burkina Faso FERSOL.
- Critchley, W. and J. Gowing (eds). 2012. Water Harvesting in Sub-Saharan Africa. Earthscan.
- Critchley, W.R.S., Reij, C. and A. Seznec. 1992. Water Harvesting for Plant Production. Volume II: Case Studies and Conclusions for Sub-Saharan Africa'. World Bank Technical Paper Number 157, Africa Technical Department Series, Washington D.C.
- Critchley, W.R.S., Cooke, R., Jallow, T., Lafleur, S., Laman, M., Njoroge, J., Nyagah, V. and E. Saint-Firmin. 1999. Promoting Farmer Innovation: harnessing local environmental knowledge in East Africa. RELMA/UNDP Workshop Report 2.
- Danert, K. and S. Sutton. 2010. Accelerating Self Supply: a case study from Uganda. Fieldnote No. 2010-4. Rural Water Supply Network (RWSN).
- Danert, K. and N. Motts. 2009. Uganda Water Sector and Domestic Rainwater Harvesting Sub-Sector Analysis. EnterpriseWorks/VITA.
- Delaney, S. 2012. Challenges and opportunities for agricultural water management in West and Central Africa: lessons from IFAD experience. International Fund for Agricultural Development (IFAD).
- FAO (Food and Agricultural Organization of the UN). 2008. Farmer field schools on land and water management in Africa. Proceedings an international workshop in Jinja, Uganda. 24 – 29 April, 2006. <ftp://ftp.fao.org/docrep/fao/011/i0383e/i0383e.pdf>
- FAO. 2001. Water Harvesting in Western and Central Africa. Proceedings of a regional workshop held in Niamey, October, 1999. Food and Agricultural Organization of the UN (FAO). Accra, Ghana. <ftp://ftp.fao.org/agl/aglw/docs/waterharvraf.pdf>
- Foster, S. and A. Tuinhof. 2004. Brazil, Kenya: Subsurface Dams to Augment Groundwater Storage in Basement Terrain for Human Subsistence. Sustainable Groundwater Management Lessons from Practice, Case Profile Collection Number 5. World Bank, Global Water Partnership Associate Programme. Washington.
- GIZ (Deutsche Gesellschaft für Internationale Zusammenarbeit). 2012. Bonnes pratiques de CES/DRS -Contribution à l'adaptation au changement climatique et à la résilience des producteurs: les expériences de quelques projets au Sahel. Bonn et Eschborn.
- GIZ (Deutsche Gesellschaft für Internationale Zusammenarbeit). 2012. Good Practices in Soil and Water Conservation. Eschborn. <http://www.giz.de/Themen/de/dokumente/giz2012-en-soil-water-conservation.pdf>
- GIZ (Deutsche Gesellschaft für Internationale Zusammenarbeit). 2006. Zanjás de infiltración, La Paz, Bolivia. [http://proagro-bolivia.org/files/CARTILLA\\_4\\_ZANJAS\\_infiltracion.pdf](http://proagro-bolivia.org/files/CARTILLA_4_ZANJAS_infiltracion.pdf)
- Goetter, J. 2010. Adaptación al Cambio Climático: Cosecha de Agua de Lluvia con “Atajados” en Bolivia, Lima, Peru. Deutsche Gesellschaft für Internationale Zusammenarbeit (GIZ). [http://www.riesgoycambioclimatico.org/documentos/ACC\\_con\\_CA.pdf](http://www.riesgoycambioclimatico.org/documentos/ACC_con_CA.pdf)
- Goetter, J. 2010b. El Cambio Climático en el área rural del Sur de Cochabamba y Norte de Potosí (Bolivia); La Paz, Bolivia. Deutsche Gesellschaft für Internationale Zusammenarbeit (GIZ). <http://www.riesgoycambioclimatico.org/biblioteca/archivos/DC1115.pdf>
- Goetter, J. 2010. Water Harvesting: a promising climate change adaptation option for traditional Andean agriculture in Bolivia. Deutsche Gesellschaft für Internationale Zusammenarbeit (GIZ). In Rural Development News 2/2010. [http://www.agridea-international.ch/fileadmin/10\\_International/PDF/RDN/RDN\\_2010/9\\_Water\\_harvesting.pdf](http://www.agridea-international.ch/fileadmin/10_International/PDF/RDN/RDN_2010/9_Water_harvesting.pdf)
- Jiang, Z. (director editorial board) et al. 2008. Best practices for land degradation control in dryland areas of China. Land Degradation Assessment in Drylands (FAO-LADA), World Overview of Conservation Approaches and Technologies (WOCAT) and PRC-GEF Partnership on Land Degradation in Dryland Ecosystems, China. <https://www.wocat.net/en/knowledge-base/documentation-analysis/national-books-factsheets.html?category=14>
- Junghou, W. and V. Vallerani. 2010. The Afforestation of a Pilot Area through the Application of the “Vallerani System” Technology in the Inner Mongolia Autonomous Region. Implementation Report for the Sino-Italy Cooperation Project.
- Kowsar, S.A. 2011. Floodwater spreading and spate irrigation in Iran. Spate Irrigation Network.
- Kumar, P. and B.M. Kandpal. 2003. Project on Reviving and Constructing Small Water Harvesting Systems in Rajasthan, Sida Evaluation 03/40, Swedish International Development Cooperation Agency (Sida), Department for Asia, Stockholm, Sweden.
- Liniger, H. and W. Critchley (eds). 2007. Where the land is greener: case studies and analysis of soil and water conservation initiatives worldwide. World Overview of Conservation Approaches and Technologies (WOCAT).
- Liniger, H., Mekdaschi Studer, R., Hauert, C. and M. Gurtner. 2011. Sustainable Land Management in Practice: Guidelines and Best Practices for Sub-Saharan Africa. TerAfrica, World Overview of Conservation Approaches and Technologies (WOCAT) and Food and Agriculture Organization of the United Nations (FAO).
- LUCOP (Lutte Contre la Pauvreté). 2004. Référentiel des mesures techniques de récupération, de protection et d'exploitation durable des terres, 2ème édition. Coopération Nigéro – Allemande. Programme Régional Tillabéri, Bureau Régional Niamey.
- Mahnot, S. 2003. Water Harvesting Management: Improving Land Management in Rajasthan. SDC/Intercooperation Coordination Unit. Jaipur, India.
- Mutunga, K. and W. Crichley. 2001. Farmers' Initiatives in Land Husbandary: Promising Technologies for the Drier Areas of East Africa. Regional Land Management Unit (RELMA), Swedish International Development Cooperation Agency (Sida). RELMA Technical Report Series 27. Nairobi.
- NEPCAT (Nepal WOCAT). 2008. Natural Resource and Management Approaches and Technologies in Nepal. NEPCAT fact sheets. Centre for Integrated Mountain Development (ICIMOD). Kathmandu, Nepal. <https://www.wocat.net/en/knowledge-base/documentation-analysis/national-books-factsheets.html?category=14>
- Ngigi, S. N. 2003. Rainwater Harvesting for Improved Food Security: Promising Technologies in the Greater Horn of Africa. Greater Horn of Africa Rainwater Partnership (GHARP) and Kenya Rainwater Association (KRA), Nairobi, Kenya
- Oduor, A.R. and H.M. Gadain. 2007. Potential of Rainwater Harvesting in Somalia: a Planning, Design, Implementation and Monitoring Framework. Project Report No W-09. World Agroforestry Centre (ICRAF). Nairobi, Kenya.
- Orodho, A. (not dated). Tumbukiza technology: an alternative method of Napier grass production. Betuco.be.
- Oudra, I. 2011. Spate irrigation in Morocco. Spate Irrigation Network.

- REST (The Relief Society of Tigray). 2011. An overview of REST's implementation of the Productive Safetynet Programme. Field Exchange, Emergency Nutrition Network, Issue 40, pp. 59-66.
- ROOSE, E., Sabir, M. and A. Laouina (eds). 2010. Gestion durable des eaux et des sols au Maroc : valorisation des techniques traditionnelles méditerranéennes. Institut de recherche pour le développement (IRD). Marseille, France. <http://www.documentation.ird.fr/hor/fdi:010054917>
- Schwilch, G., Hessel, R. and S. Verzaandvoort (eds). 2012. Desire for Greener Land: Options for Sustainable Land Management in Drylands. Bern, Switzerland, and Wageningen, The Netherlands: University of Bern – CDE, Alterra – Wageningen UR, ISRIC – World Soil Information and CTA – Technical Centre for Agricultural and Rural Cooperation.
- Taamallah, H. (ed). 2010. Gestion durable des terres en Tunisie: bonnes pratiques agricoles. Land Degradation Assessment in Drylands (FAO-LADA), World Overview of Conservation Approaches and Technologies (WOCAT) and Institut des Régions Arides (IRA), Médenine.
- Tekle, H.K. 2012. Community Spate Irrigation in Raya Valley: the Case of Three Spate Irrigation Systems. LAP LAMBERT Academic Publishing.
- Tuinhof, A., van Steenberg, F., Vos, P. and L. Tolk. 2012. Profit from Storage: the costs and benefits of water buffering. 3R Water Secretariat. Wageningen, The Netherlands.
- Van den Ham, J.P. 2008. Dodota spate irrigation system Ethiopia: a case study of spate irrigation management and livelihood options. Irrigation and Water Engineering, Wageningen University.
- Van Dijk, J.A. and M. Ahmed. 1993. Opportunities for Expanding Water Harvesting in Sub-Saharan Africa: the Case of the Teras of Kassala. International Institute for Environment and Development (IIED). Sustainable Agriculture and Rural Livelihoods Programme.
- Van Steenberg, F. and A. Tuinhof. 2009. Managing the Water Buffer for Development and Climate Change Adaptation: Groundwater Recharge, Retention, Reuse and Rainwater Storage. UNESCO International Hydrological Programme. Paris.
- Van Steenberg, F., Tuinhof, A. and L. Knoop. 2011. Transforming Lives Transforming Landscapes: the Business of Sustainable Water Buffer Management. 3R Water Secretariat. Wageningen, The Netherlands.
- Water Charity. 2012. Conclusion of St. Martin Secondary School Rainwater Harvesting Project – Kenya.
- WBI (World Bank Institute). 2010. Rehabilitating a Degraded Watershed: a Case Study from China's Loess Plateau. Case-based learning. Learning series on sustainable water and land management. World Bank. <http://wbi.worldbank.org/wbi/Data/wbi/wbicms/files/drupal-acquia/wbi/0928313-03-31-10.pdf>
- WOCAT (World Overview of Conservation Approaches and Technologies). 2012. WOCAT Database: Technologies. <http://cdewocat.unibe.ch/wocatQT/index.php>.
- Wolfgang, B. (coordinator). 2011. Sustainable Land Management (SLM) Technologies and Approaches in Tajikistan. Tajikistan Pilot Programme for Climate Resilience (PPCR). [https://www.wocat.net/fileadmin/user\\_upload/documents/Books/Tajikistan\\_wocat-collection2011\\_eng\\_final.pdf](https://www.wocat.net/fileadmin/user_upload/documents/Books/Tajikistan_wocat-collection2011_eng_final.pdf)
- WOTR (Watershed Organisation Trust). not dated. Mandwa Village: the Metamorphosis of Life after Water Seeped into its Soil.... Watershed Voices: Experience from the grassroots. WOTR. Maharashtra, India. <http://www.wotr.org/wp-content/uploads/2012/05/Mandwa-village-NEW-WS-voices.pdf>

## Manuals, practical guides and training material

### General

- Critchley, W. and K. Siegert. 1991. Water Harvesting: a Manual for the Design and Construction of Water harvesting Schemes for Plant Production. FAO, Rome. <http://www.fao.org/docrep/U3160E/U3160E00.htm#Contents>
- Denison, J., Smulders, H., Kruger, E., Houghton, T. and M. Botha. 2011. Water Harvesting and Conservation. Volume 1: Development of a comprehensive learning package. Research Report No.TT 492/11. South African Water Resource Commission.
- Denison, J., Smulders, H., Kruger, E., Ndingi, H. and M. Botha. 2011. Water Harvesting and Conservation. Volume 2: Part 1: Technical Manual and Farmer Handouts (Research Report No.TT 493/11), Part 2: Facilitation and Assessment Guide for the Technical Manual (Research Report No.TT 494/11), Part 3: Facilitation Manual (Research Report No.TT 495/11), Part 4: Facilitation and Assessment Guide for the Facilitation Manual (Research Report No.TT 496/11). South African Water Resource Commission.
- FAO. 2012. Discovery based learning in land and water management, a practical guide for farmer field schools (16 modules). Module 10: managing rainwater; Module 11: water for crops; Module 12: harvesting water for people and for livestock. Food and Agriculture Organization (FAO), Rome, Italy.
- Hatibu, N. and H.F. Mahoo (eds.). 2000. Rainwater Harvesting for Natural Resources Management: A planning guide for Tanzania. Technical Handbook No. 22, Sida Regional Land Management Unit (RELMA), Nairobi.
- Hughes, O. and J.H. Venema. 2005. Module pour Champs – Ecole des Producteurs – Gestion de l'eau de pluie au niveau de l'exploitation agricole. FAO. [ftp://ftp.fao.org/agl/agll/docs/ffsfm\\_zim.pdf](ftp://ftp.fao.org/agl/agll/docs/ffsfm_zim.pdf)
- Hurni, H. 1986. Guidelines for Development Agents on Soil Conservation in Ethiopia. Ministry of Agriculture, Natural Resources Conservation and Development. Community Forests and Soil Conservation Development Department (CFSCDD). Addis Abbaba, Ethiopia.
- IFAD. 2012. Technical, financial and economic tool on roof rainwater harvesting. International Fund for Agricultural Development (IFAD), Rome, Italy.
- IFAD. 2001. Rainwater harvesting design manual for irrigated agriculture in marginal areas. International Fund for Agricultural Development (IFAD). Rome.
- Jaetzold, R., Schmidt, H., Hornetz, B. and C. Shisanya. 2005. Farm Management Handbook of Kenya, Volume II (second edition), Nairobi. GTZ.
- LaBranche, A., Wack, H.O., Crawford, D., Crawford, E., Sojka, N.J. and C. Brand. 2007. Virginia Rainwater Harvesting Manual. The Cabell Brand Center.
- Malesu, M.M., Oduor, A.R. and O.J. Odhiambo (eds). 2007. Green Water Management Handbook: rainwater harvesting for agricultural production and ecological sustainability. Technical Manual No. 8 World Agroforestry Centre (ICRAF), Nairobi, Kenya and Netherlands Ministry of Foreign Affairs.
- Nissen-Petersen, E. 2007. Water supply by rural builders. ASAL Consultants Ltd., Nairobi, Kenya. For the Danish International Development Agency (DANIDA) in Kenya.
- Rochette, R.M. (ed). 1989. Le sahel en lutte contre la desertification: leçons d'experiences. Comité Inter-Etats de Lutte contre la Sécheresse au Sahel (CILSS). Margraf. Weikersheim, Germany.
- Schauwecker, C. 2010. A Water Harvesting Guide for Extension Workers: Water Harvesting Manual and Catalogue. Bern University of Applied Sciences, School of Agriculture, Forest and Food Sciences.
- South Pacific Applied Geoscience Commission (SOPAC). 2004. Harvesting the Heavens. A manual for participatory training in rainwater harvesting. South Pacific Applied Geoscience Commission (SOPAC) for the United Nations Environment Programme (UNEP) in conjunction with the Tonga Community Development Trust (TCDT). <http://www.pacificwater.org/pages.cfm/water-services/rainwater-harvesting/>
- UNEP (United Nations Environment Programme), IRCSA (International Rainwater Catchment Systems Association), FAKT (Consult for Management, Training and Technologies) and MARGRAF Publishers. 2005. Rainwater Harvesting etoolkit. <http://rainwater-toolkit.net>

## Floodwater harvesting

- Anonymous. 2008. Design manual [for spate irrigation civil works infrastructure]. Volume 1: Technical Design Criteria. Volume 2: Guidelines for Wadi Diversion and Protection Works. Volume 3: Design Presentations. The European Union's Food Security Programme for Yemen Technical Assistance to the Tihama Development Authority. <http://www.spate-irrigation.org>
- Betifor. 2010. Effets des seuils d'épandage dans la région de Tahoua: cultures sous pluies et contre saison. Campagne 2009/2010. Rapport global provisoire. FICOD. Niger.
- Chunhong, H., Deyi, W., Jayakumar R. and S. Ajisawa (eds). 2004. Warping dams – Construction and its Effects on Environment, Economy, and Society in Loess Plateau Region of China. International Hydrological Programme (IHP), UNESCO Office Beijing & The International Research and Training Center on Erosion and Sedimentation (IRTCES), Beijing. <http://www.irtces.org/pdf-hekou/138198E.pdf>
- Nil, D., Ackermann, K., van den Akker, E., Schöning, A., Wegner, M., van der Schaaf, C. and J. Pieterse. 2012. Water-spreading weirs for development of degraded dry river valleys. Experience from the Sahel. Deutsche Gesellschaft für Internationale Zusammenarbeit (GIZ), Eschborn and KfW Entwicklungsbank, Frankfurt.
- Nil, D., Ackermann, K., van den Akker, E., Schöning, A., Wegner, M., van der Schaaf, C. et J. Pieterse. 2012. Seuils d'épandage pour la valorisation des vallées d'oued dégradées. Expériences du Sahel. Deutsche Gesellschaft für Internationale Zusammenarbeit (GIZ), Eschborn and KfW Entwicklungsbank, Frankfurt.
- Madrell, S. and I. Neal. 2012. Sand Dams: a Practical Guide. Excellent Development. London.UK
- Ratsey, J. 2011. Engineering Manual for Spate Irrigation. Technical Assistance for the Support to the Agricultural Sector / Food Security Programme in Eritrea. Wiltshire, Landell Mills Limited. <http://www.spate-irrigation.org/guidelines>
- Spate Irrigation Network. Training materials from Yemen, Ethiopia and Pakistan. Spate Irrigation Network. <http://www.spate-irrigation.org/resource-documents/training-material>

## Macrocatchment water harvesting

- Collins, S. 2000. Hand-dug shallow wells. Series of Manuals on Drinking Water Supply. SKAT. St.Gallen. <http://www.rwsn.ch/documentation/skatdocumentation.2005-11-14.6529097230/file>
- Durand, J-M. 2012. Les petits barrages de décrue en Mauritanie : Recommandations pour la conception et la construction. Fonds international de développement agricole (FIDA).
- Durand, J-M. 2012. Manuel de suivi et d'entretien des petits barrages en Mauritanie. Fonds international de développement agricole (FIDA).
- Koegel, R.G. 1985. Self-help wells. FAO Irrigation and Drainage Paper. Food and Agricultural Organisation of the UN (FAO). Rome. <http://www.fao.org/docrep/X5567E/X5567E00.htm>
- Ministries of Water Resources and Irrigation of Sudan and South Sudan. 2009. Technical Guidelines for the Construction and Management of Improved Hafirs: A Manual for Field Staff and Practitioners. MIWR-GONU (Sudan), MWRI-GOSS, UNICEF.
- Munyao, J.N., Munywoki, J.M., Kitema, M.I., Kithuku, D.N., Munguti, J.M. and S. Mutiso. 2004. Kitui Sand Dams. Construction and Operation. SASOL Foundation. Kitui, Kenya.
- Nissen-Petersen, E. 2006. Water from Dry Riverbeds: how dry and sandy riverbeds can be turned into water sources by hand-dug wells, subsurface dams, weirs and sand dams. ASAL Consultants Ltd., Nairobi, Kenya. For the Danish International Development Agency (DANIDA) in Kenya. [http://www.samsamwater.com/library/Book3\\_Water\\_from\\_Dry\\_Riverbeds.pdf](http://www.samsamwater.com/library/Book3_Water_from_Dry_Riverbeds.pdf)
- Nissen-Petersen, E. 2006a. Water from Roads: a handbook for technicians and farmers on harvesting rainwater from roads. ASAL Consultants Ltd., Nairobi, Kenya. [http://www.samsamwater.com/library/Book6\\_Water\\_from\\_roads.pdf](http://www.samsamwater.com/library/Book6_Water_from_roads.pdf)
- Nissen-Petersen, E. 2006b. Water from Rock Outcrops: a handbook for engineers and technicians on site investigations, designs, construction and maintenance of rock tanks and dams. ASAL Consultants Ltd., Nairobi, Kenya. For the Danish International Development Agency (DANIDA) in Kenya. [http://www.samsamwater.com/library/Book1\\_Water\\_from\\_Rock\\_Outcrops.pdf](http://www.samsamwater.com/library/Book1_Water_from_Rock_Outcrops.pdf)
- Nissen-Petersen E. 2006c. Water from Small Dams: handbook for technicians, farmers and others on site investigations, designs, cost estimates, construction and maintenance of small earth dams. ASAL Consultants Ltd., Nairobi, Kenya. For the Danish International Development Agency (DANIDA) in Kenya.
- Nissen-Petersen, E. 2000. Water from Sand Rivers: a manual on site survey, design, construction and maintenance of seven types of water structures in riverbeds. RELMA Technical Handbook No.23. Sida Regional Land Management Unit, Nairobi, Kenya.
- RAIN (Rainwater Harvesting Implementation Network). 2009. A practical guide to sand dam implementation: Water supply through local structures as adaptation to climate change. RAIN Foundation / Acacia Water / Ethiopian Rainwater Harvesting Association / Action for Development / Sahelian Solutions Foundation. Wageningen. [http://www.rainfoundation.org/fileadmin/PublicSite/Manuals/Sand\\_dam\\_manual\\_FINAL.pdf](http://www.rainfoundation.org/fileadmin/PublicSite/Manuals/Sand_dam_manual_FINAL.pdf)
- Reynoso, D.S.F. and J.L.O. Mota. 2010. Trampa de captación de agua de lluvia para abrevadero. Secretaria de Agricultura, Ganadería, Desarrollo Rural Pesca Y Alimentación (SAGARPA). Mexico.
- Sand dam bibliography. <https://sites.google.com/site/sdbibliography/>
- Stern, J.H. and A. Stern. 2011. Water harvesting through sand dams. ECHO Technical Note. ECHO. North Fort Myers, USA.
- Stephens, T. 2010. Manual on small earth dams: a guide to siting, design and construction. FAO Irrigation and Drainage Papers 64. FAO. Rome. <http://www.fao.org/docrep/012/i1531e/i1531e.pdf>
- VSF (Vétérinaires sans frontières). 2006. SubSurface Dams: a simple, safe and affordable technology for pastoralists. A manual on SubSurface Dams construction based on an experience of Vétérinaires sans Frontières in Turkana District (Kenya). Vétérinaires sans frontières. Brussels. <http://www.protos.be/water-in-the-world/Subsurface-damsdefvolledig.pdf>
- Wagner, B. (ed). 2005. Water from ponds, pans and dams. A manual on design, construction and maintenance. Technical Handbook No. 32. Regional Land Management (RELMA) in ICRAF. Nairobi.

## Microcatchment water harvesting

- FAO (Food and Agricultural Organization of the UN). 2000. Manual de captación y aprovechamiento del agua de lluvia: Experiencias en América Latina. Zonas áridas y semi-áridas No. 13. Santiago, Chile, Organización de las Naciones Unidas para la Agricultura y la Alimentación (FAO), Oficina Regional de la FAO para América Latina y el Caribe. <ftp://ftp.fao.org/docrep/fao/010/ai128s/ai128s00.pdf>
- Hai, M.T. 1998. Water Harvesting: an Illustrative Manual for Development of Microcatchment Techniques for Crop Production in Dry Areas. RELMA Technical Handbook. RELMA, Nairobi. <https://we.riseup.net/assets/4867/microcatchment%20for%20dry%20area%20crops.pdf>
- PROWALO. 1996. La charrue Delphine: Expérimentation dans les forêts et les terroirs du Walo. Projet d'Aménagement des Forêts et de Gestion des Terroirs Villageois du Walo (PROWALO). [http://www.vallerani.com/images/Dispensa\\_illustrata\\_PROWALO-1996.pdf](http://www.vallerani.com/images/Dispensa_illustrata_PROWALO-1996.pdf)

## Rooftop water harvesting

- Adler, I., Carmona, G. and J.A. Bojalil. 2008. Manual de captacion de aguas de lluvia para centros urbanos. PNUMA / International Renewable Resources Institute (IRRI). Mexico City, Mexico.
- Ariyananda, T. 2009. Rain Water Harvesting Practitioners Guide for Sri Lanka. Lanka Rainwater Harvesting Forum.
- Ariyawansa, S. 2009. Home Gardening through Rainwater Harvesting. Lanka Rainwater Harvesting.
- Castaneda, N.P. 2010. Propuesta de un sistema de aprovechamiento de agua lluvia, como alternativa para el ahorro de agua potable. La institución educativa Maria Auxiliadora de Caldas, Antioquia. Medellín.
- Doyle, K.C. 2008. Sizing the First Flush and its Effect on the Storage-Reliability-Yield Behavior of Rainwater Harvesting in Rwanda. Master Thesis, Department of Civil and Environmental Engineering, Massachusetts Institute of Technology.
- Development Technology Unit (DTU). 2002. Very-Low-Cost Domestic Roof Water Harvesting in the Humid Tropics: Existing Practice. Domestic Roofwater Harvesting Research Programme, Report R1. Development Technology Unit, School of Engineering, University of Warwick. Warwick, UK.
- Development Technology Unit (DTU) Forum. 2001. Recommendations for designing rainwater harvesting system tanks. Warwick, Development Technology Unit, School of Engineering, University of Warwick.
- Development Technology Unit (DTU). 2000. Low-cost, thin-shell, ferrocement tank cover- Instructions for manufacture. DTU Technical Release Series, TR-RWH 04. Development Technology Unit, School of Engineering, University of Warwick. Warwick, UK.
- FAO (Food and Agricultural Organisation of the UN). 2001. Small Dams and Weirs in Earth and Gabion Materials. FAO. Rome. <ftp://ftp.fao.org/agl/aglw/docs/misc32.pdf>
- Garduno, M.A. 1998. Sistema de Captacion de Agua de Lluvia para Uso Domestico en America Latina y el Caribe. Instituto Interamericano de Cooperacion para la Agricultura (IICA). San José, Costa Rica.
- Gould, J. and E. Nissen-Petersen. 1999. Rainwater catchment systems for domestic supply: design, construction and implementation. IT Publications. London, UK.
- Kavarana, G. and S. Sengupta. 2013. Catch water where it falls: toolkit on urban rainwater harvesting. Centre for Science and Environment (CSE). New Delhi, India.
- Keddal, H. 2007. Guide pratique pour la récupération des eaux pluviales au Maroc. Ministère de 'Aménagement du Territoire, de l'Eau et de l'Environnement. Direction du Partenariat, de la Communication et de la Coopération. Royaume du Maroc.
- Luong, T.V. 2002. Harvesting the Rain: a Construction Manual for cement Rainwater Jars and Tanks, UNICEF East Asia and Pacific Regional Office, Bangkok, Thailand.
- Macomber, P.S.H. 2010. Guidelines on Rainwater Catchment Systems for Hawaii. Manoa, College of Tropical Agriculture and Human Resources, University of Hawai'i at Manoa.
- Nega, H. and P.M. Kimeu. 2002. Low-cost methods of rainwater storage. Results from field trials in Ethiopia and Kenya. Regional Land Management Unit (RELMA). Nairobi, Kenya.
- Nissen-Petersen, E. 2007. Water from Roofs: a handbook for technicians and builders on survey, design, construction and maintenance of roof catchments. ASAL Consultants Ltd., Nairobi, Kenya. For the Danish International Development Agency (DANIDA) in Kenya. <http://www.waterforaridland.com/Books/book7%20Water%20from%20roofs.pdf>
- Nissen-Petersen, E. 1992. How to Build an Underground Tank with Dome, ASAC Consultants Ltd., Kitui, Kenya.
- Nissen-Petersen, K. 1992. How to Build Smaller Water Tanks and Jars, ASAC Consultants Ltd., Kitui, Kenya.
- Nissen-Petersen, E. and M. Lee. 1990. Harvesting Rainwater in Semi-Arid Africa – Manual Number 1: Water Tanks With Guttering and Handpump. ASAL Consultants Ltd., Nairobi, Kenya. [http://docs.watsan.net/Scanned\\_PDF\\_Files/Class\\_Code\\_2\\_Water/213.2-10144.pdf](http://docs.watsan.net/Scanned_PDF_Files/Class_Code_2_Water/213.2-10144.pdf)
- Practical Action. 2009. Rainwater Harvesting in Uganda. The Schumacher Centre. Rugby, UK. <https://practicalaction.org/rainwater-harvesting-answers>
- Practical Action. 2008. Underground Rainwater Storage Facilities. The Schumacher Centre. Rugby, UK. <https://practicalaction.org/rainwater-harvesting-answers>
- Practical Action. 2002. The Sri Lankan Pumpkin Tank: A Case Study. The Schumacher Centre. Rugby, UK. <https://practicalaction.org/rainwater-harvesting-answers>
- Practical Action. 1998. The Underground Brick Dome Tank (5 m<sup>3</sup>), Sri Lanka: A Case Study. The Schumacher Centre. Rugby, UK. <https://practicalaction.org/rainwater-harvesting-answers>
- Programa de las Naciones Unidas para el Medio Ambiente (PNUMA). 2008. Manual sobre Sistemas de Captación y Aprovechamiento del Agua de Lluvia para Uso Doméstico y Consumo Humano. 4 Parts. Programa de las Naciones Unidas para el Medio Ambiente (PNUMA), Oficina Regional para América Latina y el Caribe. Panama City. <http://www.pnuma.org/recreat/esp/documentos/>
- Rainwater Club. not dated. Manual on rooftop rainwater harvesting systems in schools: maintenance schedule, post storage treatment procedure and precautions. Rainwater Club. Bangalore, India. [www.rainwaterclub.org](http://www.rainwaterclub.org).
- The Caribbean Environmental Health Institute. 2009. Rainwater: Catch it While You Can – a Handbook on Rainwater Harvesting in the Caribbean: a practical guideline featuring best practices for rainwater harvesting in small island Caribbean environments. The Caribbean Environmental Health Institute, St.Lucia / United Nations Environment Programme (UNEP), Nairobi.
- Texas Water Development Board. 2005. The Texas Manual on Rainwater Harvesting. Third Edition. Austin, Texas. [http://www.twdb.state.tx.us/publications/reports/RainwaterHarvestingManual\\_3rdedition.pdf](http://www.twdb.state.tx.us/publications/reports/RainwaterHarvestingManual_3rdedition.pdf)
- Thoma, T. and B. McGeever. 1997. Underground storage of rainwater for domestic use including construction details of a lowcost cistern and pump. Working Paper. Warwick, Development Technology Unit, School of Engineering, University of Warwick. 49. <http://www2.warwick.ac.uk/fac/sci/eng/research/civil/crg/dtu/pubs/wp/wp49/wp49.pdf>
- Thomas, T.H. and D.B. Martinson. 2007. Roofwater Harvesting: a Handbook for Practitioners. Technical Paper Series; no. 49. International Water and Sanitation Centre (IRC). Delft, The Netherlands. <http://www.washdoc.info/docsearch/title/155697>
- Unidad de Apoyo Técnico en Saneamiento Básico Rural (UNATSABAR). 2001. Guia de diseño para captacion del agua de lluvia. Centro Panamericano de Ingeniería Sanitaria y Ciencias del Ambiente. Lima, Peru.
- Worm, J. and T. van Hattum. 2006. Rainwater harvesting for domestic use. AGROMISA and CTA / RAIN (Rainwater Harvesting Implementation Network). Wageningen, The Netherlands
- Zanzibar Water Authority. 2010. Zanzibar Rainwater Harvesting Manual for Training of Trainers for Domestic Supply (draft). Zanzibar Water Authority. <http://www.dlist-asclme.org/sites/default/files/doclib/upload%20December.pdf>

## Journal articles, conference and working papers

- Ali, A., Oweis, T., Rashid, M., El Naggar, S. and A. Aal. 2007. Water harvesting options in the drylands at different spatial scales. *Land Use and Water Resources Research* 7:1-13.
- Barron, J. and G. Okwach. 2005. Run-off water harvesting for dry spell mitigation in maize (*Zea mays* L.): results from on-farm research in semi-arid Kenya. *Agricultural Water Management* 74(1):1-21.
- Barry, B., Olaleye, A.O., Zougmore, R. and D. Fatondji. 2008. Rainwater harvesting technologies in the Sahelian zone of West Africa and the potential for outscaling. IWMI Working Paper 126. International Water Management Institute (IWMI). Colombo, Sri Lanka.
- Biazin, B., Sterk, G., Temesgen, M., Abdulkedir, A. and L. Stroosnijder. 2012. Rainwater harvesting and management in rainfed agricultural systems. in sub-Saharan Africa – A review. *Physics and Chemistry of the Earth, Parts A/B/C* 47-48 139–151.
- Botha, J.J., Joseph, L.F., Anderson, J.J. and A.F. Berhanu. 2011. Classification of rainwater harvesting technologies. Paper read at 3rd International Forum on Water and Food, Tshwane, South Africa. CGIAR Challenge Programme on Water and Food. Colombo, Sri Lanka.
- Critchley, W.R.S. and K. Mutunga. 2003. Local innovation in a global context: documenting farmer initiatives in land husbandry through WOCAT. *Land Degradation & Development*, 14(1), 143–162.
- Deryng, D., Sacks, W.J., Barford, C.C. and N. Ramankutty. 2011. Simulating the effects of climate and agricultural management practices on global crop yield. *Global Biogeochemical Cycles*, 25(2), 1–18.
- Efe, S.I. 2006. Quality of rainwater harvesting for rural communities of Delta State, Nigeria. *Environmentalist* 26:175-181.
- Ellis-Jones J. and A. Tengberg. 2000. The impact of indigenous soil and water conservation practices on soil productivity: Examples from Kenya, Tanzania and Uganda. *Land Degradation & Development* 11(1):19-36.
- Ferdausi, S.A. and M.W. Bolkland. 2000. Rainwater harvesting for application in rural Bangladesh. In 26th WEDC Conference on Water, Sanitation and hygiene: challenges of the millennium. Dhaka, Bangladesh.
- Fox, P., Rockström, J. and J. Barron. 2005. Risk analysis and economic viability of water harvesting for supplemental irrigation in semi-arid Burkina Faso and Kenya. *Agricultural Systems* 83(3):231-250.
- Hagos, F., Yohannes, M., Linderhof, V., Kruseman, G., Mulugeta, A., Samuel, G.G. and Z. Abreha. 2006. Micro water harvesting for climate change mitigation: Trade-offs between health and poverty reduction in Northern Ethiopia. PREM Working report 06-05. Poverty Reduction and Environmental Management, Institute for Environmental Studies, Vrije Universiteit, Amsterdam, The Netherlands. [http://papers.ssrn.com/sol3/papers.cfm?abstract\\_id=1527885](http://papers.ssrn.com/sol3/papers.cfm?abstract_id=1527885)
- Herweg, K. and E. Ludi. 1999. The performance of selected soil and water conservation measures: case studies from Ethiopia and Eritrea. *Catena* 36(1-2):99-114.
- Komakech, H.C., Mul, M.L., van der Zaag, P. and F.B.R. Rwehumbiza. 2011. Water allocation and management in an emerging spate irrigation system in Makanya catchment, Tanzania. *Agricultural Water Management* 98(11):1719-1726.
- Luong, T.V. and P. Luckmuang. 2002. Household rainwater harvesting: Thailand. 28th WEDC Conference on sustainable environmental sanitation and water services. Calcutta, India
- Malley, Z.J.U., Kayombo, B., Willcocks, T.J. and P.W. Mtakwa. 2004. Ngoro: an indigenous, sustainable and profitable soil, water and nutrient conservation system in Tanzania for sloping land. *Soil and Tillage Research* 77(1):47-58.
- Mehari, A., Van Steenberg, F. and B. Schultz. 2011. Modernization of Spate Irrigated Agriculture: A New Approach. *Irrigation and Drainage* 60(2):163-173.
- Mendez, C.B., Afshar, B.R., Kinney, K., Barrett, M.E. and M.J. Kirisits. 2010. Effect of Roof Material on Water Quality for Rainwater Harvesting Systems. Report. Texas Water Development Board. Austin, Texas.
- Motiee, H., McBean, E., Semsar, A., Gharabaghi, B. and V. Ghomashchi. 2006. Assessment of the contributions of traditional qanats in sustainable water resources management. *International Journal of Water Resources Development* 22(4):575-588.
- Mul, M.L., Kemerink, J.S., Vyagusa, N.F., Mshana, M.G., van der Zaag, P. and H. Makurira. 2011. Water allocation practices among smallholder farmers in the South Pare Mountains, Tanzania: the issue of scale. *Agricultural Water Management* 98(11):1752-1760.
- Mupangwa, W., Love, D. and S. Twomlov. 2006. Soil-water conservation and rainwater harvesting strategies in the semi-arid Mzingwane Catchment, Limpopo Basin, Zimbabwe. *Physics and Chemistry of the Earth* 31(15-16):893-900.
- Nasr, M. 1999. Assessing Desertification and Water Harvesting in the Middle East and North Africa: Policy Implications. Centre for Development Research (ZEF) Discussion Papers on Development Policy Number. Bonn
- Naugle, J., Opio-Oning, T. and B. Cronin. 2011. A market-based approach to facilitate self supply for rainwater harvesting in Uganda. 6th Rural Water Supply Network (RWWSN) Forum. Kampala, Uganda. November 2011.
- Ngigi, S.N. 2003. What is the limit of up-scaling rainwater harvesting in a river basin? *Physics and Chemistry of the Earth* 28(20-27):943-956.
- Niemeijer, D. 1998. Soil nutrient harvesting in indigenous teras water harvesting in eastern Sudan. *Land Degradation & Development* 9(4):323-330.
- Nijhof, S. and B.R. Shrestha. 2010. Micro-credit and rainwater harvesting. International Water and Sanitation Centre (IRC) Symposium 2010: Pumps, Pipes and Promises: Costs, Finances and Accountability for Sustainable WASH Services. The Hague, The Netherlands.
- Oweis, T. and A. Hachum. 2006. Water harvesting and supplemental irrigation for improved water productivity of dryfarming systems in West Asia and North Africa. *Agricultural Water Management* 80(1-3):57-73.
- Raju, N.J., Reddy, T.V.K. and P. Munirathnam. 2005. Subsurface dams to harvest rainwater— a case study of the Swarnamukhi River basin. Southern India. *Hydrogeology Journal*, 14(4), 526–531.
- Rockström, J. 2000. Water resources management in smallholder farms in Eastern and Southern Africa: an overview. *Physics and Chemistry of the Earth* 25(3):275-283.
- Rockström, J. and M. Falkenmark. 2000. Semiarid Crop Production from Hydrological Perspective: Gap between Potential and Actual Yields. *Critical Reviews in Plant Sciences*, vol 19, no 4, pp319-346
- Rockström, J., Folke, C., Gordon, L., Hatibu, N., Jewitt, G., Penning de Vries, F., Rwehumbiza, F., Sally, H., Savenije, H. and R. Schulze. 2004. A watershed approach to upgrade rainfed agriculture in water scarce regions through water system innovations: an integrated research initiative on water for food and rural livelihoods in balance with ecosystem functions. *Physics and Chemistry of the Earth* 29:1109-1118.
- Somme, G., Oweis, T., Abdulal, A., Bruggeman, A. and A. Ali. 2004. Micro-catchment Water Harvesting for Improved Vegetative Cover in the Syrian Badia. On-Farm Water Husbandry Research Report Series No.3. International Center for Agricultural Research in the Dry Areas (ICARDA). Aleppo, Syria.
- Tanji, K. and N. Kielen. 2002. Agricultural drainage water management in arid and semi-arid areas. FAO Irrigation and Drainage Papers 61. FAO. Rome. <ftp://ftp.fao.org/agl/aglw/docs/idp61e.pdf>
- Tesfai, M. and L. Stroosnijder. 2001. The Eritrean spate irrigation system. *Agricultural Water Management* 48(1):51-60.
- Van Dijk, J.A. 1997. Indigenous soil and water conservation by teras in eastern Sudan. *Land Degradation & Development* 8(1):17-26.
- Van Steenberg, F., Haile, A.M., Alemehayu, T., Alamirew, T. and Y. Geleta. 2011b. Status and Potential of Spate Irrigation in Ethiopia. *Water Resources Management* 25(7):1899-1913.

- Vilane, B.R.T. and E.J. Mwendera. 2011. An inventory of rainwater harvesting technologies in Swaziland. *African Journal of Agricultural Research*. Vol. 6(6), pp. 1313-1321.
- Vohland, K. and B. Barry. 2009. A review of in situ rainwater harvesting (RWH) practices modifying landscape functions in African drylands, *Agriculture, Ecosystems & Environment*, vol. 131, no. 3-4, pp. 119-127.
- Wakindiki, I.I.C. and M. Ben-Hur. 2002. Indigenous soil and water conservation techniques: effects on runoff, erosion, and crop yields under semi-arid conditions. *Australian Journal of Soil Research* 40(3):367-379.
- Wu, Y., Tang, Y. and C.M. Huang. 2009. Harvesting of rainwater and brooklets water to increase mountain agricultural productivity: a case study from a dry valley of southwestern China. *Natural Resources Forum* 33(1):39-48.
- Zaal, F. and R.H. Oostendorp. 2002. Explaining a miracle: Intensification and the transition towards sustainable small-scale agriculture in dryland Machakos and Kitui Districts, Kenya. *World Development* 30(7):1271-1287.
- Zougmore, R., Zida, Z. and N.F. Kambou. 2003. Role of nutrient amendments in the success of half-moon soil and water conservation practice in semiarid Burkina Faso. *Soil & Tillage Research* 71(2):143-149.

## Policy briefs, fact sheets, presentations and others

- Agriwaterpedia. Water Harvesting. Accessed December 2012. [http://agriwaterpedia.info/wiki/Water\\_Harvesting](http://agriwaterpedia.info/wiki/Water_Harvesting).
- Baziwe, D. 2011. Putting women at the forefront in accelerating self supply through domestic rainwater harvesting. 6th Rural Water Supply Network (RWSN) Forum: Rural water supply in the 21st century: myths of the past, visions for the future. Kampala, Uganda. November 2011. <http://www.washdoc.info/docsearch/title/177104>
- Benli, B. 2012. Rain Water Harvesting. United Nations Development Programme (UNDP). Presentation available from [http://www.unece.org/fileadmin/DAM/env/water/meetings/TF\\_EWE/2nd\\_meeting/power\\_points/Water\\_Harvesting.pdf](http://www.unece.org/fileadmin/DAM/env/water/meetings/TF_EWE/2nd_meeting/power_points/Water_Harvesting.pdf).
- Cleveringa, R., Kay, M. and A. Cohen (eds.). 2009. InnoWat: Water, innovations, learning and rural livelihoods. International Fund for Agricultural Development (IFAD). Rome, Italy. [http://www.ifad.org/english/water/innowat/strategic/Overview\\_web.pdf](http://www.ifad.org/english/water/innowat/strategic/Overview_web.pdf)
- FAOSTAT. 2012. Database. Food and Agriculture Organization (FAO), Rome. Accessed June 2012. <http://faostat.fao.org/>
- GIZ (Deutsche Gesellschaft für Internationale Zusammenarbeit). 2011. Fact sheet: Water Spreading Weirs. GIZ, Eschborn and KfW Entwicklungsbank, Frankfurt. [http://www.solutionsforwater.org/wp-content/uploads/2011/12/Flyer-Nexus\\_waterspreading-weirs.pdf](http://www.solutionsforwater.org/wp-content/uploads/2011/12/Flyer-Nexus_waterspreading-weirs.pdf)
- IFAD (International Fund for Agricultural Development) website. Topics: Spate Irrigation. Accessed December 2012. <http://www.ifad.org/english/water/innowat/topic/irrigation.htm>
- IFAD (International Fund for Agricultural Development). InnoWat case studies, fact sheets, tool sheets, topic sheets. <http://www.ifad.org/english/water/innowat/index.htm>
- Oweis, T.Y. 2009. Managing water resources under scarcity and climate change. Presentation for IFAD-ICARDA knowledge and technology exchange in NENA region.
- Picard, J. not dated. Fact sheet: Water Spreading Weirs: methods and tools. GIZ, PDRD-PRODABO. Chad.
- Practical Action. 2009. Rainwater harvesting in Uganda. Technical Brief, the Schumacher Centre. Rugby, UK. <https://practicalaction.org/rainwater-harvesting-answers>
- Practical Action. 2008. Runoff Rainwater Harvesting. Technical Brief. The Schumacher Centre. Rugby, UK. [http://practicalaction.org/docs/technical\\_information\\_service/rainwater\\_harvesting.pdf](http://practicalaction.org/docs/technical_information_service/rainwater_harvesting.pdf)
- Practical Action. 2002. Water harvesting in Sudan. Technical Brief, the Schumacher Centre. Rugby, UK. <http://cdn1.practicalaction.org/w/a/4f55e1d8-6858-4a8c-a6de-74950ae4f5bb.pdf>
- Practical Action. 2002. Sand Dams: Feasible Rainwater Harvesting Technology for Arid and Semi-Arid Land. Technical Brief, the Schumacher Centre. Rugby, UK. <https://practicalaction.org/rainwater-harvesting-answers>
- Practical Action. 2002. Runoff Rainwater Harvesting: the Path to Enhanced Livelihoods. Technical Brief, the Schumacher Centre. Rugby, UK. <https://practicalaction.org/rainwater-harvesting-answers>
- Prinz, D. 2011. The Concept, Components and Methods of Rainwater Harvesting (presentation). In 2nd Arab Water Forum "Living with Water Scarcity", 20-23 November, 2011. Cairo, Egypt.
- Miller, J.W. 2009. Farm ponds for water, fish and livelihoods. Diversification booklet number 13. FAO. Rom. <ftp://ftp.fao.org/docrep/fao/011/i0528e/i0528e.pdf>
- Nawaz K. 2011. Desert Truffle Mushrooms in Spate Irrigation Areas. Spate Irrigation Network.
- Scheierling S. (Water Anchor, TWIWA, World Bank). 2011. Adapting Soil-Water Management to Climate Change: Insights from a Portfolio Review (presentation). Learning Session: Climate-Smart Agriculture. Agriculture and Rural Development (ARD) Days 2011.
- UNEP (United Nations Environment Programme). 2012. Sudan Environmental Database. [http://postconflict.unep.ch/sudanreport/sudan\\_website/](http://postconflict.unep.ch/sudanreport/sudan_website/)
- UNEP (United Nations Environment Programme). 2008. Endowment opportunities from rainwater in Africa. In *Encyclopedia of Earth*. [http://www.eoearth.org/article/Endowment\\_opportunities\\_from\\_rainwater\\_in\\_Africa](http://www.eoearth.org/article/Endowment_opportunities_from_rainwater_in_Africa)
- UN-HABITAT. not dated. Measures for Ensuring Sustainability of Rainwater Harvesting. Water for Asian Cities Programme – UN-HABITAT, Directorate of Urban Administration and Development Government of Madhya Pradesh, India.
- WaterAid. not dated. Rainwater harvesting. Technical Brief. WaterAid International NGO. London, UK. [http://www.wateraid.org/documents/plugin\\_documents/rainwater\\_harvesting.pdf](http://www.wateraid.org/documents/plugin_documents/rainwater_harvesting.pdf)
- WB (World Bank). 2012. Rainfed Agriculture. Accessed June 2012. <http://water.worldbank.org/topics/agricultural-water-management/rainfed-agriculture>.
- WB (World Bank). 2011. Climate-Smart Agriculture: a call to action. [http://climatechange.worldbank.org/sites/default/files/documents/CSA\\_Brochure\\_web\\_WB.pdf](http://climatechange.worldbank.org/sites/default/files/documents/CSA_Brochure_web_WB.pdf)
- Wilk, J. and H.B. Wittgren (eds). 2009. Adapting Water Management to Climate Change. Policy Brief Nr. 7. Swedish Water House. Stockholm International Water Institute (SIWI).
- WRI (World Resources Institute). 2012. Where are the world's drylands? Accessed June 2012. <http://www.wri.org/publication/content/8236>

## Selection of audio-visual media

- AccessAgriculture. Contour bunds. Language: English. Length: 15.0 min. <http://www.accessagriculture.org/node/511/en>
- FAO (Food and Agriculture Organization). 2003. Training course on water harvesting. FAO Land and Water Digital Media Series – CD-ROM 26
- BBC – EARTH REPORT. 2003. Tunnel Vision. Film. Produced by: Sapiens Productions. Language: English. <http://www.sapiensproductions.com/qanats.htm>
- Centre de Recherche et des Technologies des Eaux (CERTE) Tunisie. 2008. La récupération des eaux pluviales en Tunisie. Video. Produced by: Sapiens Productions. Language: French. Length: 15:43. [http://www.thewaterchannel.tv/index.php?option=com\\_hwdvideoshare&task=viewvideo&Itemid=53&video\\_id=597](http://www.thewaterchannel.tv/index.php?option=com_hwdvideoshare&task=viewvideo&Itemid=53&video_id=597)
- CPWC (Programme on Water and Climate). 2006. Kitui Sand Dams. Video. Produced by: Arena Films. Language: English. Length: 14 min. <http://www.thewaterchannel.tv/>
- Danert, K. 2009. How Household Investment in Rural Water Supply can make a difference: Summary of Video/Audio Conference Discussions. RWSN, WSP, A4A and SDC. Excellent Development. 2009. Sand dams in Kenya. Video. Produced by: Excellent Pioneers of Sand Dams. Language: English. Length: 7.47 min. <http://www.youtube.com/watch?v=YjzcfPax4As&noredirect=1>
- FAKT.1996. Mvua ni Maji – Rain is Water, Rainwater Harvesting by Women's Groups in Kenya. Video. Produced by: Kenyan film team. Length: 27 min.
- Hartung, H. 2002. The Rainwater Harvesting CD. Margraf Publishers, Germany. [info@margraf-verlag.de](mailto:info@margraf-verlag.de) or [HansFHartung@aol.com](mailto:HansFHartung@aol.com)
- IIED (International Institute for Environment and Development) and IFAD (International Fund for Agricultural Development). 2012. Series on Sustainable Land Management Technologies in sub-Saharan Africa. Videos. Directed by: William Critchley. Produced by: Josephine Rodgers (Country Wise Communication). Language: English. Length: 12 x 8 min with accompanying information sheets. <http://www.thewaterchannel.tv/>
- IIED (International Institute for Environment and Development) Clips. Climate Change Adaptation Technology: Stone Lines. Language: English. Length: 7.27. [http://www.youtube.com/watch?v=RQkiv\\_U5AoU&feature=player\\_embedded#!](http://www.youtube.com/watch?v=RQkiv_U5AoU&feature=player_embedded#!)
- IIED (International Institute for Environment and Development) Clips. Climate Change Adaptation Technology: Fanya Juu Terraces. Language: English. Length: 5:27. [http://www.youtube.com/watch?v=b9Z\\_wYjyBCE&feature=player\\_embedded](http://www.youtube.com/watch?v=b9Z_wYjyBCE&feature=player_embedded)
- IRHA (International Rainwater Harvesting Alliance). Farm ponds. Water harvesting structures in semi arid areas. Video. Produced by: Vishwanath Srikanthiah. Language: English. Length: 1:47 min. [http://www.irha-h2o.org/?page\\_id=50&vpage=3](http://www.irha-h2o.org/?page_id=50&vpage=3)
- IUCN (The International Union for Conservation of Nature). 2011. Of pearls in the sand. Video documentary. Produced by Umbreen Butt and Iskan Khan on behalf of IUCN Pakistan. Language: subtitled English. <http://www.iucn.org/about/union/secretariat/offices/asia/?uNewsID=9050>
- Lanka Rainwater Harvesting Forum. A Gift from the Sky – An Overview of Roofwater Harvesting in Sri Lanka. <http://www.rainwaterharvesting.com>
- RAIN. 2009. Sand dam training in Southern Ethiopia. Video. Produced by: Africa Interactive on behalf of RAIN. Language: English. <http://www.thewaterchannel.tv/>
- Rain Harvesting. How to install and maintain a first flush water diverters? 2 Videos. Produced by: Rain Harvesting Pty Ltd. Language: English. Length: 1.02 and 1.55 min. <http://rainharvesting.com.au/products/pre-filtration/first-flush-water-diverter/downpipe-first-flush-diverter>
- Rainwater Club. Harvesting Water – 10 videos. <http://www.rainwaterclub.org/movies.htm>
- UNESCO Multimedia Web & Services. Water and systems of irrigation in Central Iran: Qanat, Water, Oasis. Video. Produced by: Abdolhamid Baghaeian. Language: English. Length: 24:56 min. [http://www.unesco.org/archives/multimedia/index.php?s=film\\_details&id\\_page=33&id\\_film=2369](http://www.unesco.org/archives/multimedia/index.php?s=film_details&id_page=33&id_film=2369)
- Vincent, P. 2011. Collecting rain water using Vetiver. Language: English. Length: 2.02 min. [http://www.youtube.com/watch?v=e482unvd3uc&feature=player\\_embedded#!](http://www.youtube.com/watch?v=e482unvd3uc&feature=player_embedded#!)
- Water for Arid Land. 2010. Sand dams vs Subsurface dams. Video. Produced by: ASAL Consultants, Erik Nissen-Petersen. Language: English. Length: 7.54 min. <http://www.thewaterchannel.tv/en/videos/categories/viewvideo/630/water-harvesting/nissen-petersen-sand-dams-vs-subsurface-dams>
- Water for Arid Land. 2010. Water from roads. Video. Produced by: ASAL Consultants, Erik Nissen-Petersen. Language: English. <http://www.thewaterchannel.tv/en/videos/categories/viewvideo/631/water-harvesting/water-from-roads>
- Water for Arid Land. 2010. Water from rocks. Video. Produced by: ASAL Consultants, Erik Nissen-Petersen. Language: English. Length: 12.01 min. <http://www.thewaterchannel.tv/en/videos/categories/viewvideo/639/water-harvesting/water-from-rocks>
- Water for Arid Land. 210. Scope for rainwater harvesting in Eastern Africa – Interview with Erik Nissen-Petersen. Video. Produced by: The Water Channel. Language: English. Length: 04.18 min. [http://www.thewaterchannel.tv/index.php?option=com\\_hwdvideoshare&task=viewvideo&Itemid=53&video\\_id=615](http://www.thewaterchannel.tv/index.php?option=com_hwdvideoshare&task=viewvideo&Itemid=53&video_id=615)
- WOTR (Watershed Organisation Trust). Sattechiwadi: A village Transformed. Video. Produced by: WOTR. Language: English. <http://youtu.be/FKY0Lnsahil>; more WOTR films on <http://youtube.com/user/wotrindia>
- Spate Irrigation Network. 2012. What is spate irrigation? Video. Produced by: The Water Channel. Language: English. [http://www.thewaterchannel.tv/index.php?option=com\\_hwdvideoshare&task=viewvideo&Itemid=4&video\\_id=1216](http://www.thewaterchannel.tv/index.php?option=com_hwdvideoshare&task=viewvideo&Itemid=4&video_id=1216)
- Spate Irrigation Network. 2011. Climate Variability and Food Security. Video. Produced by: The Water Channel. Language: English. [http://www.thewaterchannel.tv/index.php?option=com\\_hwdvideoshare&Itemid=4&task=viewvideo&video\\_id=1122](http://www.thewaterchannel.tv/index.php?option=com_hwdvideoshare&Itemid=4&task=viewvideo&video_id=1122)
- Spate Irrigation Network. 2011. Water Rights in spate irrigation. Video. Produced by: The Water Channel. Language: English. <http://www.thewaterchannel.tv/en/videos/categories/viewvideo/1129/agriculture/water-rights-in-spate-irrigation>
- Spate Irrigation Engineering. 2012. Lessons from Past Interventions. Video. Produced by: The Water Channel. Language: English. [http://www.thewaterchannel.tv/index.php?option=com\\_hwdvideoshare&Itemid=4&task=viewvideo&video\\_id=1249](http://www.thewaterchannel.tv/index.php?option=com_hwdvideoshare&Itemid=4&task=viewvideo&video_id=1249)
- Water for Arid Land. 2010. Water from roads. Video. Produced by: Asal Consultants, Erik Nissen-Petersen. Language: English. <http://www.thewaterchannel.tv/en/videos/categories/viewvideo/631/water-harvesting/water-from-roads>
- More videos about water harvesting can be found on <http://www.thewaterchannel.tv/>







# Water Harvesting

Guidelines to Good Practice

 Schweizerische Eidgenossenschaft  
Confédération suisse  
Confederazione Svizzera  
Confederaziun svizra

Swiss Agency for Development  
and Cooperation SDC



Enabling poor rural people  
to overcome poverty

*u<sup>b</sup>*

UNIVERSITÄT  
BERN

CDE  
CENTRE FOR DEVELOPMENT  
AND ENVIRONMENT

